

Installer and user guide for domestic reverse osmosis system

Einbau- und Bedienungsanleitung für Umkehrosmose-Haushaltssysteme

Інструкція з підключення та експлуатації системи зворотного осмосу

Інструкція по підключенню и експлуатации системы обратного осмоса

Manual privind conectarea și exploatarea sistemului de osmoză inversă

Інструкція за монтаж и експлоатация на битови системи за обратна осмоза

Uputstvo za ugradnju, upotrebu i održavanje sistema povratne osmoze

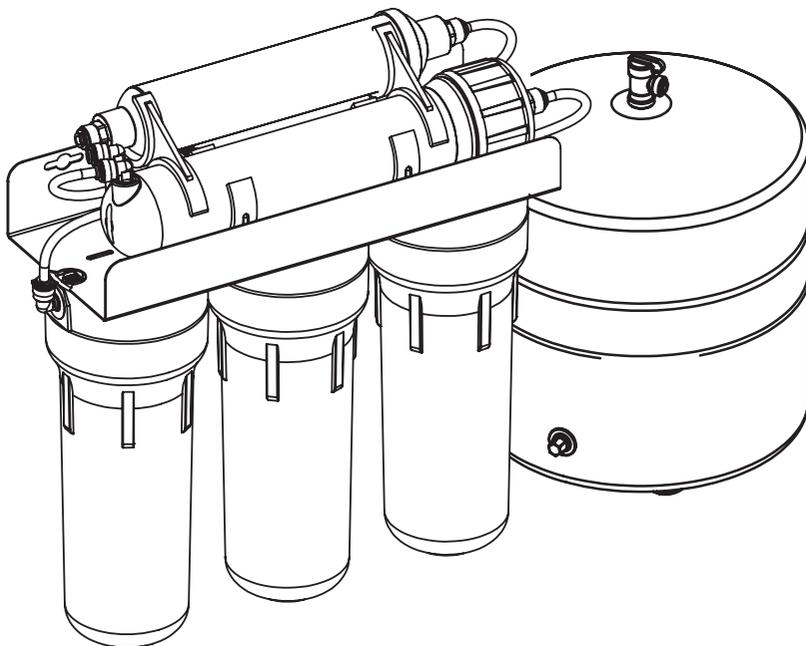

CONTENTS

1	Purpose of the product	4
2	Specifications and components	6
2.1	Model designations	6
2.2	Specifications and requirements	7
2.3	Supply water quality requirements	7
2.4	Reverse osmosis system components	8
3	Connection Diagrams	10
3.1	Connection diagram for base model	10
3.2	Connection diagram for unit with mineralizing post-filter	11
3.3	Connection diagram for unit with ultraviolet lamp	12
3.4	Connection diagram for unit with booster pump	13
3.5	Connection diagram for unit with booster pump and mineralizing post-filter	14
3.6A	Connection diagram for unit with ultraviolet lamp and mineralizing post filter with single lever faucet	15
3.6B	Connection diagram for unit with ultraviolet lamp and mineralizing post filter with double lever faucet	16
3.7	Connection diagram for unit with booster pump and ultraviolet lamp	17
3.8A	Connection diagram for unit with booster pump, ultraviolet lamp, and mineralizing post filter with single lever faucet	18
3.8B	Connection diagram for unit with booster pump, ultraviolet lamp, and mineralizing post filter with double lever faucet	19
3.9A	Connection diagram for unit P'URE with single lever faucet	20
3.9B	Connection diagram for unit P'URE with double lever faucet	21
3.9C	Connection diagram for unit P'URE AquaCalcium with single lever faucet	22
4	Steps for installing reverse osmosis system	23
4.1	Verify your setup	22
4.2	Installation procedure	23
5	Steps after installation	27
6	Usage	27
6.1	Parts of the filter and their recommended change out rates	28
6.2	The procedure for replacing pre-filter cartridges	28
6.3	The procedure for replacing membrane	30
6.4	The procedure for replacing carbon post-filter and/or mineralizing post-filter	31
6.5	The procedure for replacing UV lamp	31
7	Sanitization of reverse osmosis filter	33
7.1	Sanitization of pressure tank	35
8	Troubleshooting	37
9	Service record	40
10	Environmental and health safety	42
11	Purchasing	42
12	Transportation and storage	42
13	Warranty	42

1. PURPOSE OF THE PRODUCT

Reverse osmosis is by far the most advanced technology of water purification in use today. Special semipermeable membrane structure similar in its properties to the membrane of a living cell is capable of purifying drinking water from virtually all harmful impurities, including nitrates and viruses (see Figure 1). The membrane can be conceived of as having tiny pores, 200 times smaller than viruses and 4000 times smaller than bacteria. Domestic water filters with reverse osmosis membranes harness the principle of body's metabolism on a cellular level. Only molecules of certain size can penetrate cellular membrane.

Reverse osmosis system is a five-stage filtration unit functioning as follows (see section 2.4 for reference numbers). Filter rack is connected to cold water supply with feed water adapter 4 and feed valve 5. Red tube carries water from feed valve to the (rightmost) bulb filter rack. Incoming water then passes through pre-filter cartridges 9. Pre-filter cartridges are designed to remove solids (such as rust, sand, silt, etc), residual chlorine and organochlorines from water. After undergoing pre-treatment steps in the pre-filters, water enters into the fourth (and the most important) stage: reverse osmosis membrane 11 contained in a special housing. Inlet of membrane housing is connected with the third (leftmost) bulb filter rack through the feed side of auto shut-off valve (four-way valve fastened to the top of filter rack). One of the two outlets supplies purified water (permeate), and the other carries away water with rejected impurities (concentrate). The membrane purifies water at the molecular level by passing through its pores only the water molecules and the molecules of dissolved oxygen.

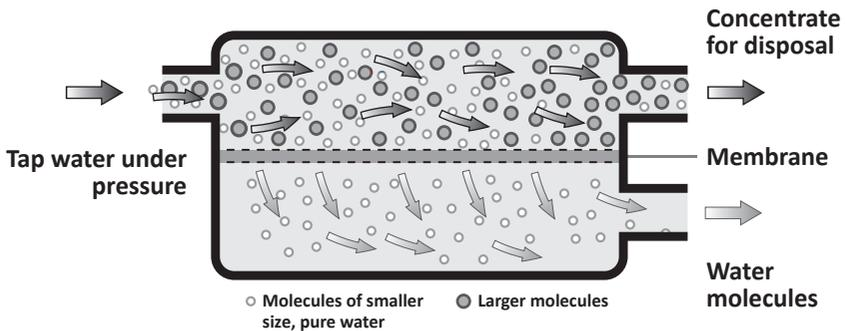

Figure 1

1. PURPOSE OF THE PRODUCT

ENG

Inside the membrane, water is separated into two streams: concentrate, which is discharged into drain, and permeate, which enters pressure tank 2 for storage. The tank is connected to the output through the membrane auto shut-off valve and check valve built into the transition fitting that is installed in the permeate outlet of membrane housing. After the auto shut-off valve is installed the union tee, through which the tank is connected to the filter rack with the yellow tube. On the top of the tank, tank valve 6 is installed.

Pressure tank of the system accumulates purified water. Without it, reverse osmosis membrane wouldn't be able to produce sufficient flow for direct water consumption. For example, if the filter had an installed membrane with a performance of 50 GPD (7.9 L / h), it would take over 1.5 min to fill the glass of 200 ml or 2 min for the 9 oz glass. Thus, the system stores purified water in the tank and delivers it to the user as needed, and then generates a supply of water. Time required to fill empty tank can range from 1.5 to 3 hours. After the tank has been filled the auto shut-off valve shuts off the water supply from the pre-filters and the unit stops. After opening purified water faucet 3, the pressure of water in the tank lowers, and the auto shut-off valve automatically resumes the flow of water through the pre-filter cartridges to the membrane to re-fill pressure tank. Water with retained impurities (concentrate) is discharged into drain through the concentrate outlet, connected with black tube to drain saddle 8, which is installed on drain pipe. In order to create backpressure, which is required to maintain the operating pressure inside the membrane housing, flow restrictor 14 is installed in the black tube. Flow restrictor is a plastic insert with precision bore capillary. The flow restrictor is inserted inside the end of black tube that is fitted in the membrane concentrate outlet.

When drawn from the faucet, purified water runs from the pressure tank through the union tee through to the fifth stage of purification—carbon post-filter, intended for the final purification of water. It contains high quality activated carbon made from coconut shell. This filter improves and refines flavor of purified water. Carbon post-filter is connected with blue tube to the drinking water faucet 3 mounted on sink or counter.

2. SPECIFICATIONS AND COMPONENTS

2.1. MODEL DESIGNATIONS

Models

MO 5-36(50,75,100)
MO 5-36(50,75,100)P
MO 6-36(50,75,100)M
MO 6-36(50,75,100)MAC
MO 6-36(50,75,100)MP
MO 6-36(50,75,100)UV
MO 6-36(50,75,100)UVP
MO 7-36(50,75,100)MUV
MO 7-36(50,75,100)MUVP

Model of your system



- 1 — The type of filter. RO stands for reverse osmosis.
- 2 — Number of stages.
- 3 — Capacity of reverse osmosis membrane in GPD (gallons per day)*:

36GPD	136 liters per day	5.6 liters per hour (1.5 gallons per hour)
50GPD	190 liters per day	7.9 liters per hour (2 gallons per hour)
75GPD	280 liters per day	11.6 liters per hour (3.1 gallons per hour)
100GPD	380 liters per day	15.8 liters per hour (4.2 gallons per hour)

*Capacity of the reverse osmosis filter is variable and depends on a number of factors. These include supply water quality, wear of pre-filter cartridges and of membrane itself, supply water pressure and temperature.

- 4 — Legend of additional equipment (no letters specify base model with no extra equipment):

M	The filter is equipped with mineralizing post-filter
MAC	The filter with AquaCalcium water mineralization technology
P	The filter is equipped with pressure booster pump
UV	The filter is equipped with ultraviolet disinfection unit

- 5 — Trademark.

For example: Ecosoft MO775MUVPECOEXP means reverse osmosis unit with 7 stages equipped with membrane of 75 gallon per day capacity (11.6 l / h (3 gal / h)), mineralizing post-filter, UV lamp, and booster pump. Trademark ECOSOFT.

** Models equipped with a pressure booster pump (marked with the letter “P” in the model designation), are intended for connection to the single-phase AC power with a voltage of 230 V, 50 Hz. The system is equipped with a power cord with a plug and should be connected in the proper type of socket with grounding complying with the local standards. **Electrical safety notice:** this appliance should be connected into a circuit with an RCB installed. Before performing any operations system must be disconnected from the electric power source.

CAUTION!

Filter installation should be carried out by a specialist with appropriate qualifications and experience. The product should only be used with cold water supply!

2. SPECIFICATIONS AND COMPONENTS

2.2. SPECIFICATIONS AND REQUIREMENTS

	Parameter	Value
1	Main pressure (no booster pump), barg (psi)	3-6* (43-87)
2	Main pressure (booster pump installed), barg (psi)	2-4.5 (29-65)
3	Tank bladder pressure, barg (psi)	0.4-0.6** (5.8-8.7)
4	Feed water temperature, °C (°F)	+4...+30*** (39...86)
5	Weight of the system (base model), kg (pounds)	6 (13.2)
6	Ambient temperature, °C °F	+5...+40*** +41...+104
7	Water supply connection	½" thread
8	Filter dimensions, H×W×D (basic assembly), mm inch	350x450x150 13.8x17.7x5.9
9	Tank dimensions, H×W×D, mm inch	350x260x260 13.8x10.2x10.2

* If supply water pressure is below required value, purchase pumped model or fit your existing filter with booster pump. If the pressure in the water system is above the limit, it is necessary to install a pressure regulator on the main pipe.

** If pressure in tank bladder is outside this range, it is necessary to pump up or release the pressure until it conforms to the requirement.

*** If supply water temperature is up in the range of +20...+30 °C (+68...+86 °F), rejection of impurities will be decreased and system capacity increased, bringing about an increase in TDS. Using the product with supply water temperature in excess of +30 °C (+86 °F) is not recommended.

2.3. SUPPLY WATER QUALITY REQUIREMENTS*

	Index	VALUE**
1	pH	6.5-8.5
2	TDS	<1500 ppm
3	Hardness	<500 ppm CaCO ₃ (<28 °dH)
4	Free chlorine	<0.5 ppm
5	Iron	<0.3 ppm
6	Manganese	<0.1 ppm
7	Chemical oxygen demand	<5 ppm O ₂
8	Total bacterial count (TBC)	<50 CFU/mL
9	E. coli titer	<3

* If water supply does not meet the requirements, service life of membrane and/or pre-filter cartridges may be shortened.

** If your home is supplied with raw wellwater, perform laboratory test of your water before installing a reverse osmosis filter. If any of your water indices exceed the limit, consider using a water treatment system to correct supply water quality. Refer to water treatment specialists or companies for advice and proper equipment selection.

2. SPECIFICATIONS AND COMPONENTS

2.4. REVERSE OSMOSIS SYSTEM COMPONENTS

The manufacturer reserves the right to modify product design or specific components, if such modification does not entail deterioration of consumer properties of the product.

1) Filter rack

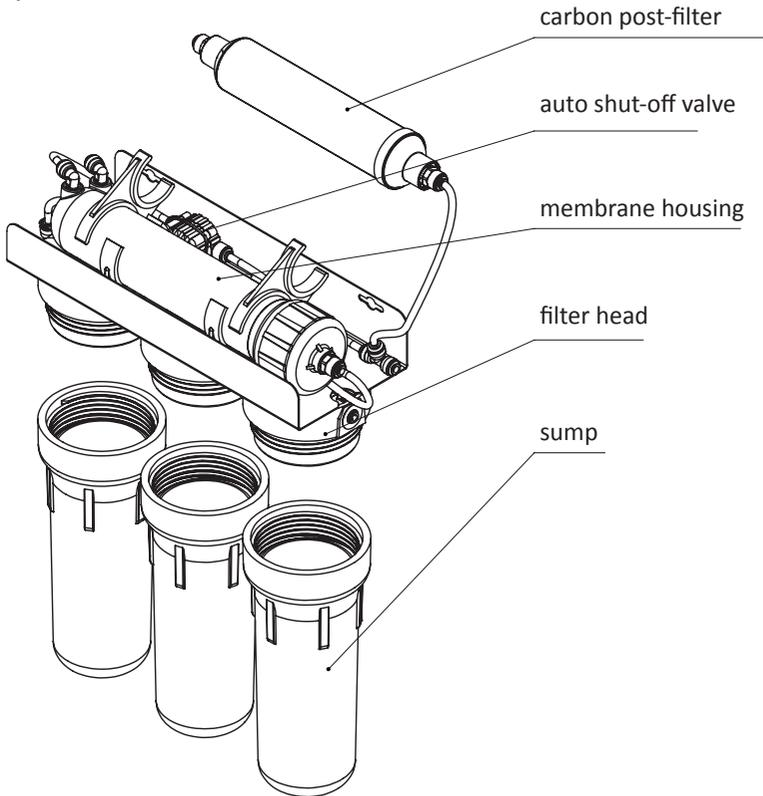

Options:

booster pump

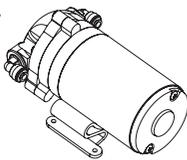

UV lamp

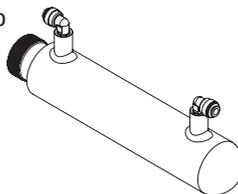

mineralizing post-filter
(and/or other type of post-filter)

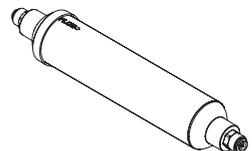

2. SPECIFICATIONS AND COMPONENTS

2.4. REVERSE OSMOSIS SYSTEM COMPONENTS

2) Pressure tank

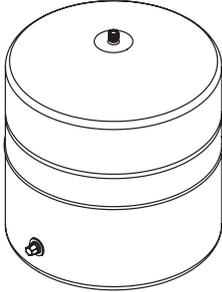

3) Drinking water faucet

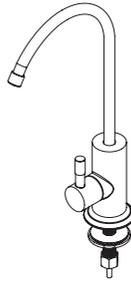

4) Feed water adapter



5) Feed valve

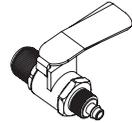

6) Tank valve



7) Set of colored tubes (4 pieces)



8) Drain saddle

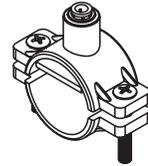

9) Set of pre-filter cartridges (may vary with model)

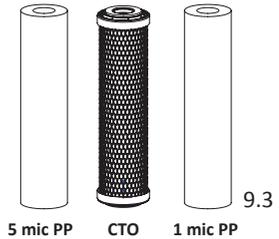
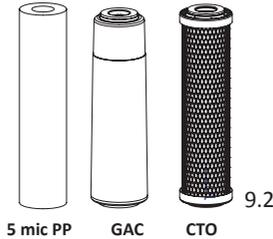
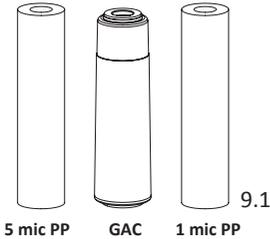

10) Sump wrench

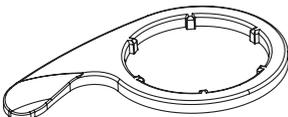

11) Reverse osmosis membrane

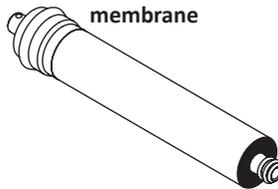

12) Flow restrictor

(inserted in black tube)

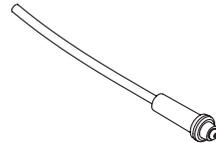

13) Locking clip: accessory securing push-fit connections from inadvertent disconnection in easily accessible locations. Presence of the clip has no effect on tightness of the connection. Quantity of clips in your reverse osmosis filter may vary depending on design of the product, and has no bearing on its performance.



3. CONNECTION DIAGRAMS

3.1. CONNECTION DIAGRAM FOR BASE MODEL

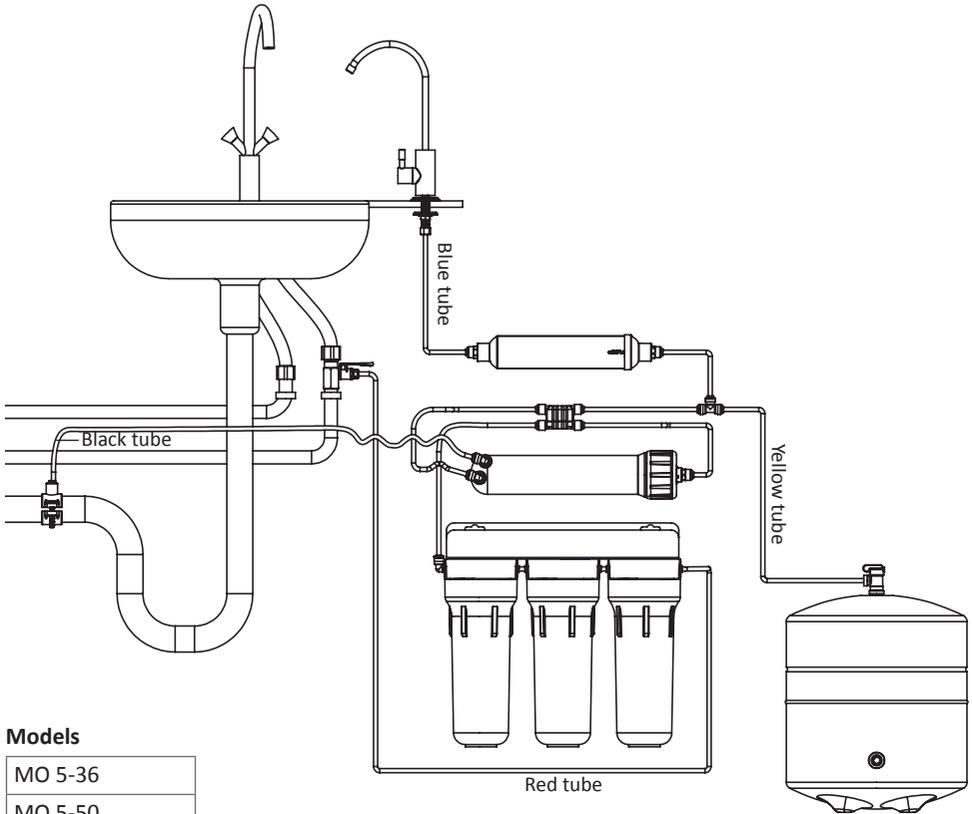

Models

MO 5-36
MO 5-50
MO 5-75
MO 5-100

The manufacturer reserves the right to modify product design or specific components, if such modification does not entail deterioration of consumer properties of the product.

3. CONNECTION DIAGRAMS

3.2. CONNECTION DIAGRAM FOR UNIT WITH MINERALIZING POST-FILTER

ENG

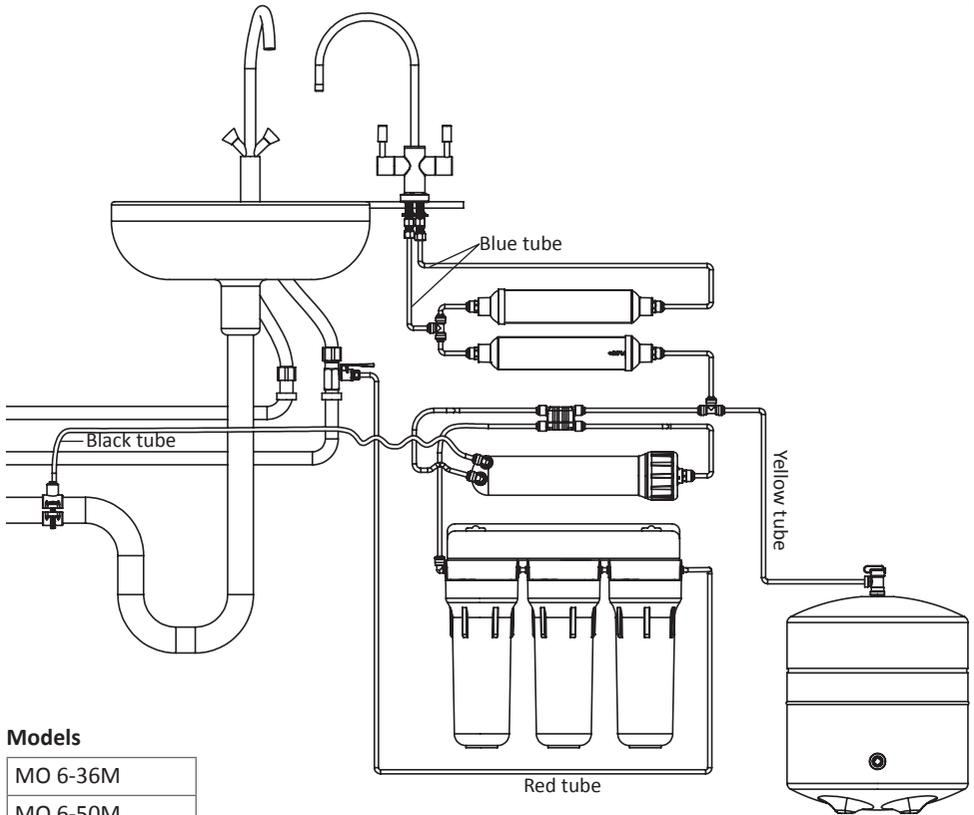

Models

MO 6-36M
MO 6-50M
MO 6-75M
MO 6-100M

The manufacturer reserves the right to modify product design or specific components, if such modification does not entail deterioration of consumer properties of the product.

3. CONNECTION DIAGRAMS

3.3. CONNECTION DIAGRAM FOR UNIT WITH ULTRAVIOLET LAMP

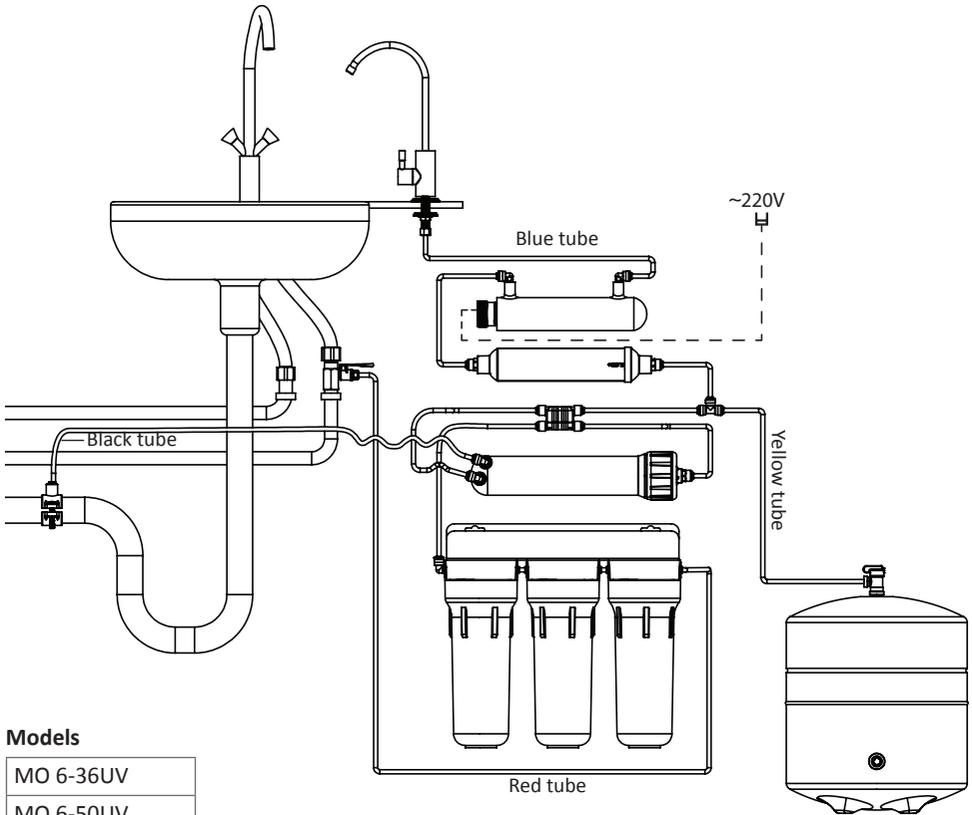

Models

MO 6-36UV
MO 6-50UV
MO 6-75UV
MO 6-100UV

The manufacturer reserves the right to modify product design or specific components, if such modification does not entail deterioration of consumer properties of the product.

3. CONNECTION DIAGRAMS

3.4. CONNECTION DIAGRAM FOR UNIT WITH BOOSTER PUMP

ENG

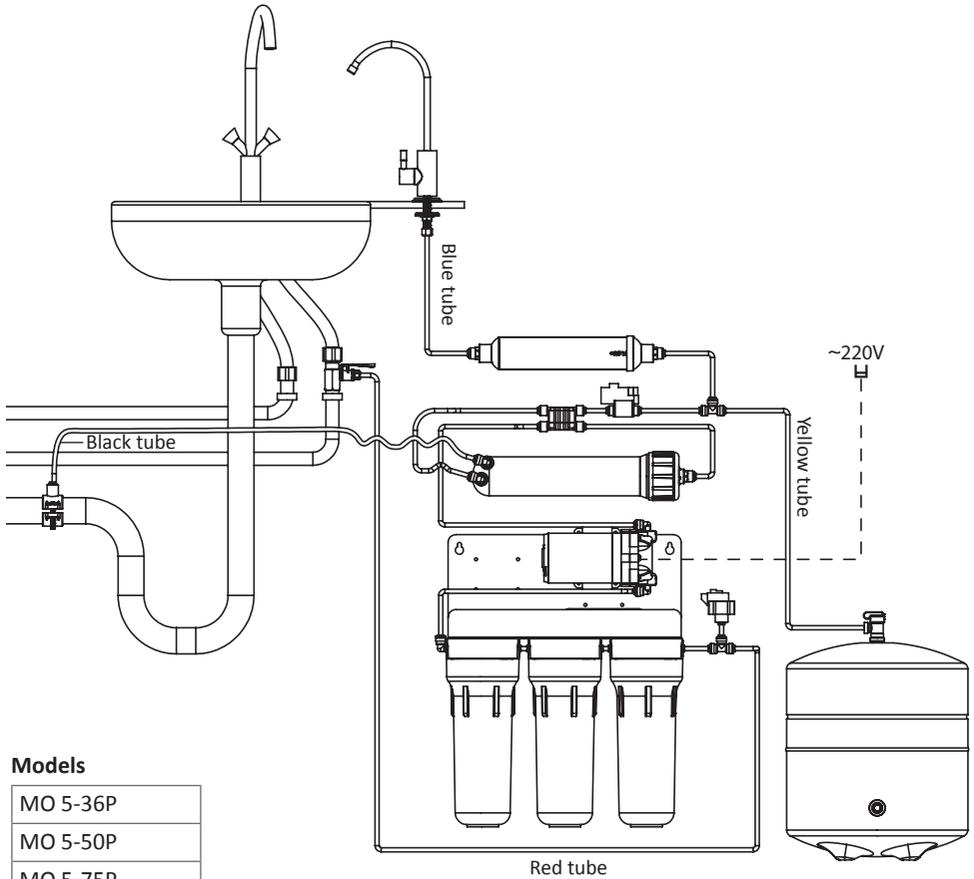

Models

MO 5-36P
MO 5-50P
MO 5-75P
MO 5-100P

The manufacturer reserves the right to modify product design or specific components, if such modification does not entail deterioration of consumer properties of the product.

3. CONNECTION DIAGRAMS

3.5. CONNECTION DIAGRAM FOR UNIT WITH BOOSTER PUMP AND MINERALIZING POST-FILTER

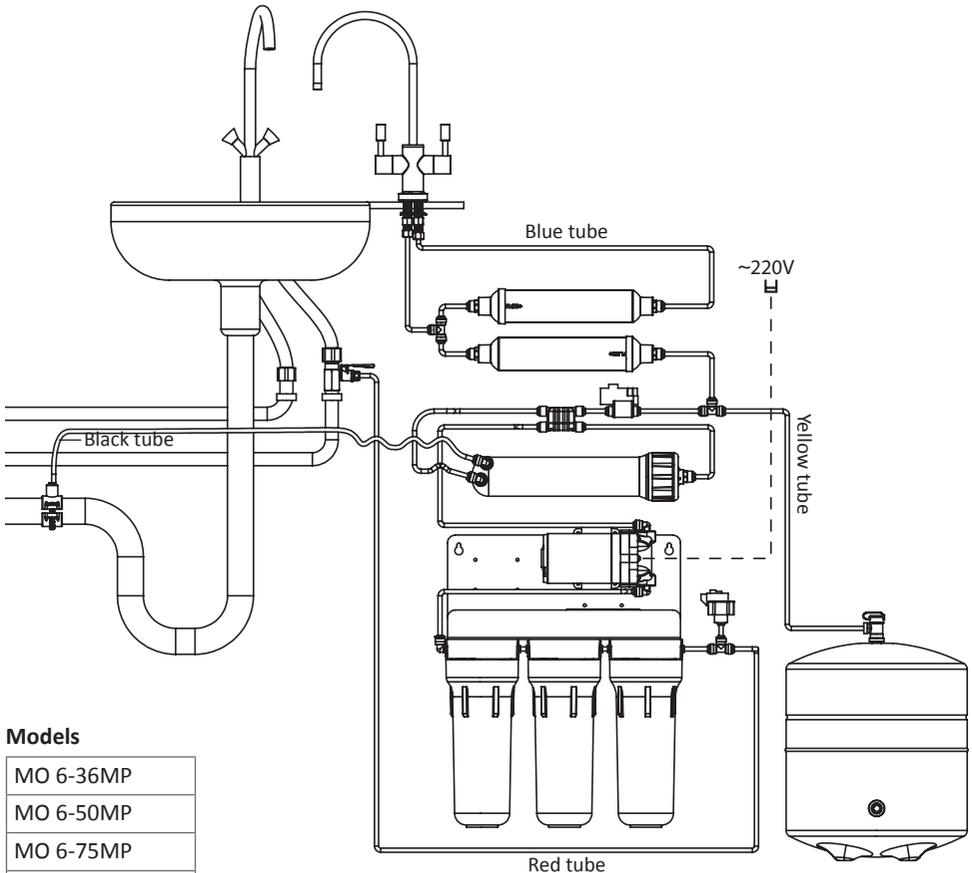

Models

MO 6-36MP
MO 6-50MP
MO 6-75MP
MO 6-100MP

The manufacturer reserves the right to modify product design or specific components, if such modification does not entail deterioration of consumer properties of the product.

3. CONNECTION DIAGRAMS

3.6A. CONNECTION DIAGRAM FOR UNIT WITH ULTRAVIOLEET LAMP AND MINERALIZING POST-FILTER WITH SINGLE LEVER FAUCET

ENG

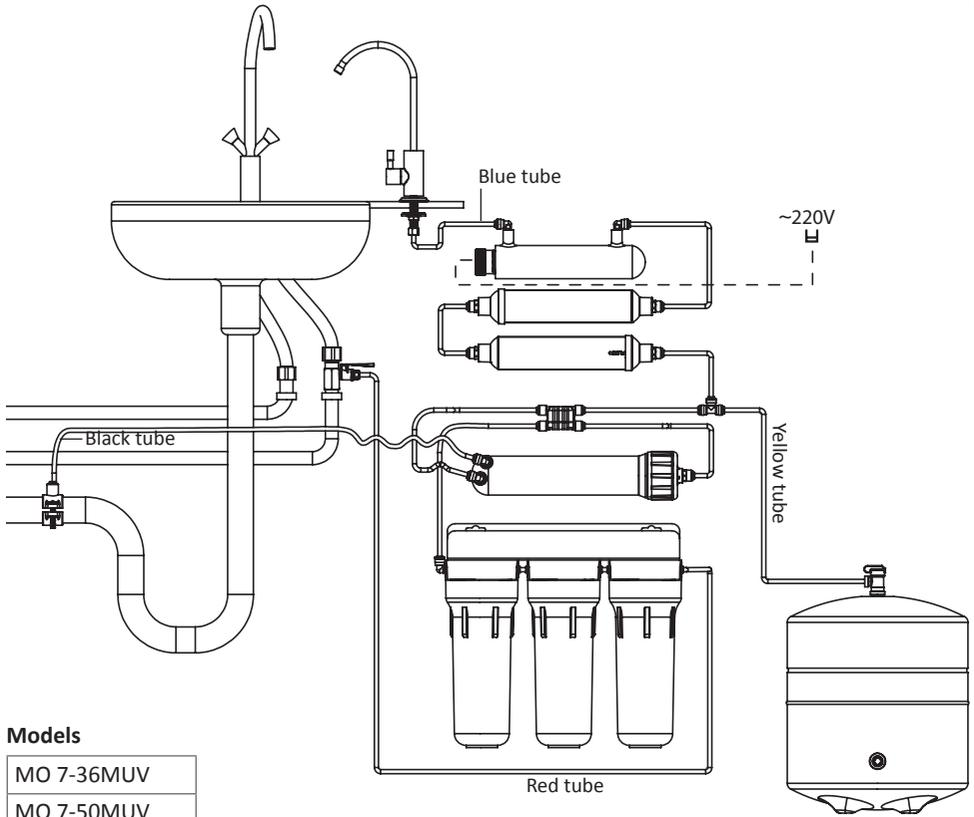

Models

MO 7-36MUV
MO 7-50MUV
MO 7-75MUV
MO 7-100MUV

The manufacturer reserves the right to modify product design or specific components, if such modification does not entail deterioration of consumer properties of the product.

3. CONNECTION DIAGRAMS

3.6B. CONNECTION DIAGRAM FOR UNIT WITH ULTRAVIOLETO LAMP AND MINERALIZING POST-FILTER WITH DOUBLE LEVER FAUCET

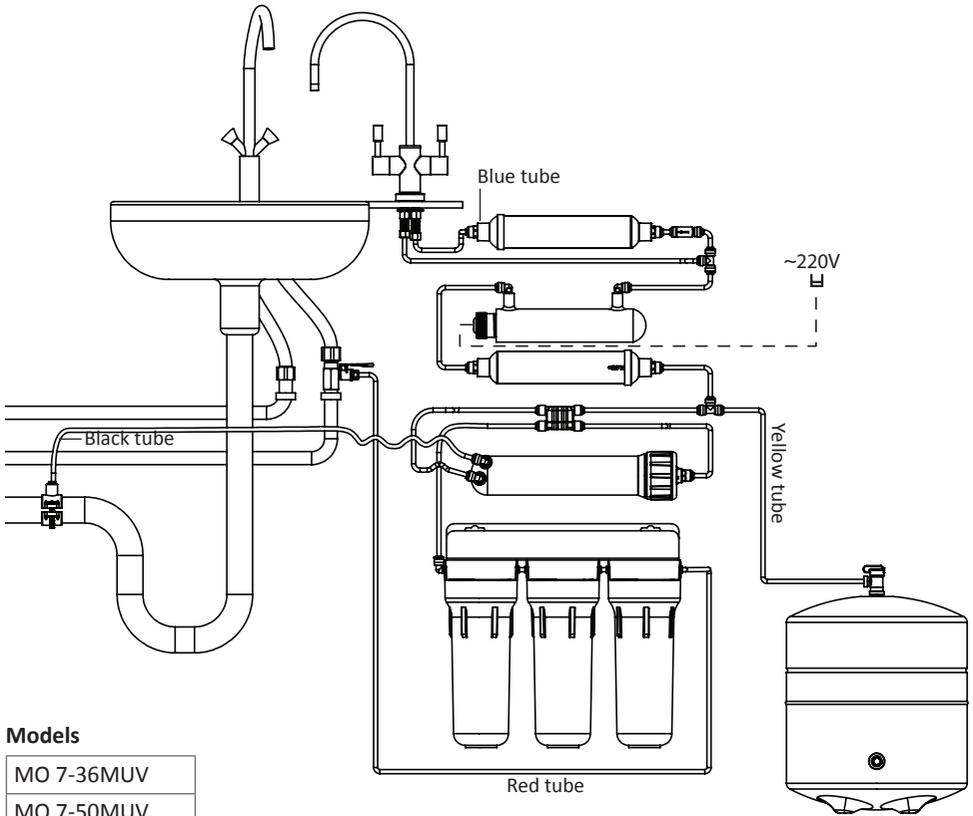

Models

MO 7-36MUV
MO 7-50MUV
MO 7-75MUV
MO 7-100MUV

The manufacturer reserves the right to modify product design or specific components, if such modification does not entail deterioration of consumer properties of the product.

3. CONNECTION DIAGRAMS

3.7. CONNECTION DIAGRAM FOR UNIT WITH BOOSTER PUMP AND ULTRAVIOLET LAMP

ENG

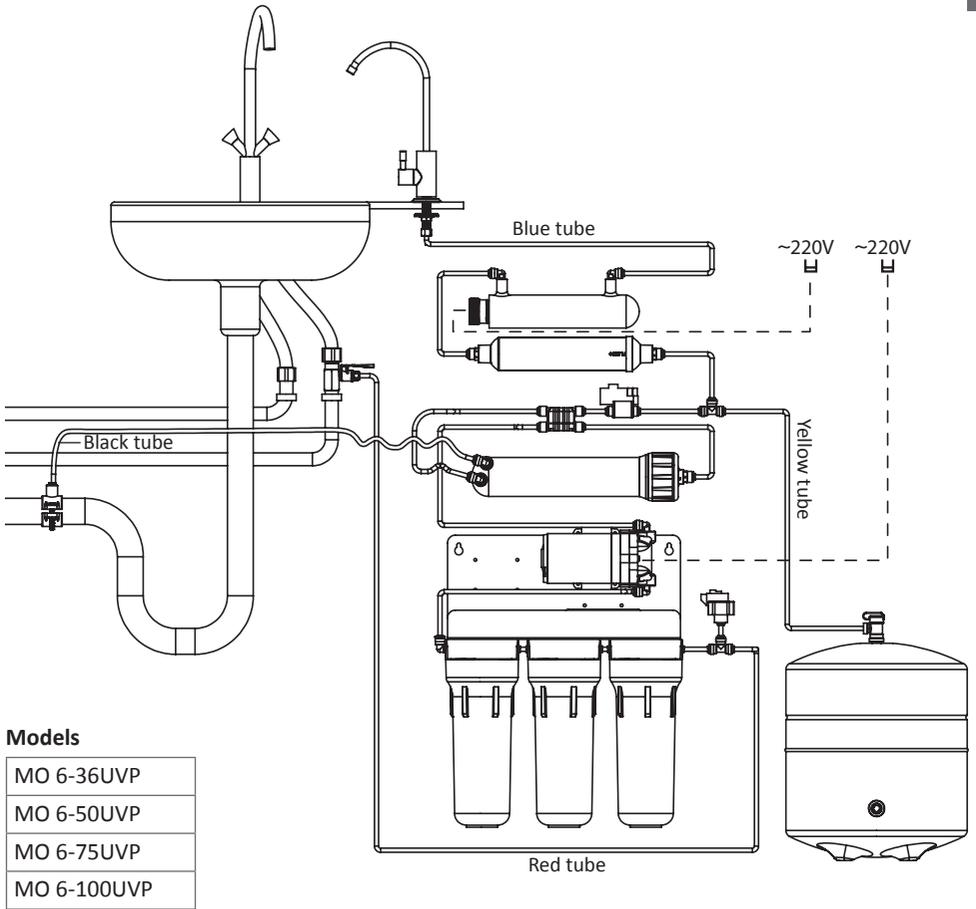

The manufacturer reserves the right to modify product design or specific components, if such modification does not entail deterioration of consumer properties of the product.

3. CONNECTION DIAGRAMS

3.8A. CONNECTION DIAGRAM FOR UNIT WITH BOOSTER PUMP, ULTRAVIOLET LAMP, AND MINERALIZING POST-FILTER WITH SINGLE LEVER FAUCET

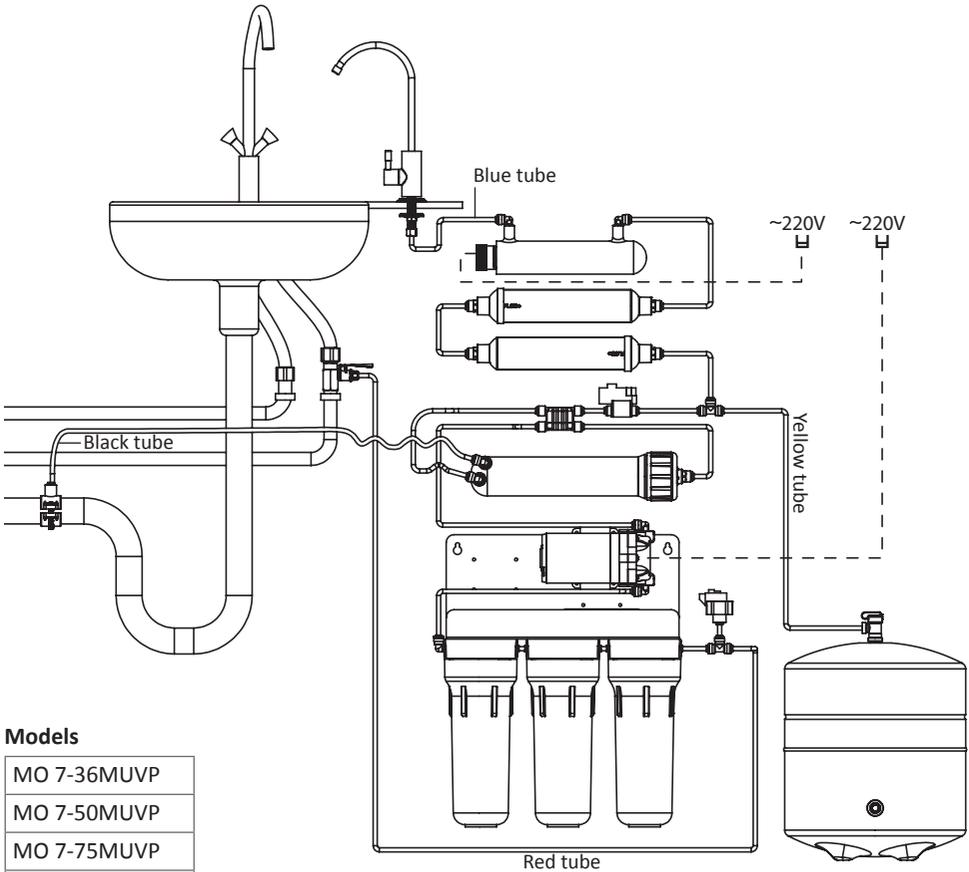

Models

MO 7-36MUVP
MO 7-50MUVP
MO 7-75MUVP
MO 7-100MUVP

The manufacturer reserves the right to modify product design or specific components, if such modification does not entail deterioration of consumer properties of the product.

3. CONNECTION DIAGRAMS

3.8B. CONNECTION DIAGRAM FOR UNIT WITH BOOSTER PUMP, ULTRAVIOLET LAMP, AND MINERALIZING POST-FILTER WITH DOUBLE LEVER FAUCET

ENG

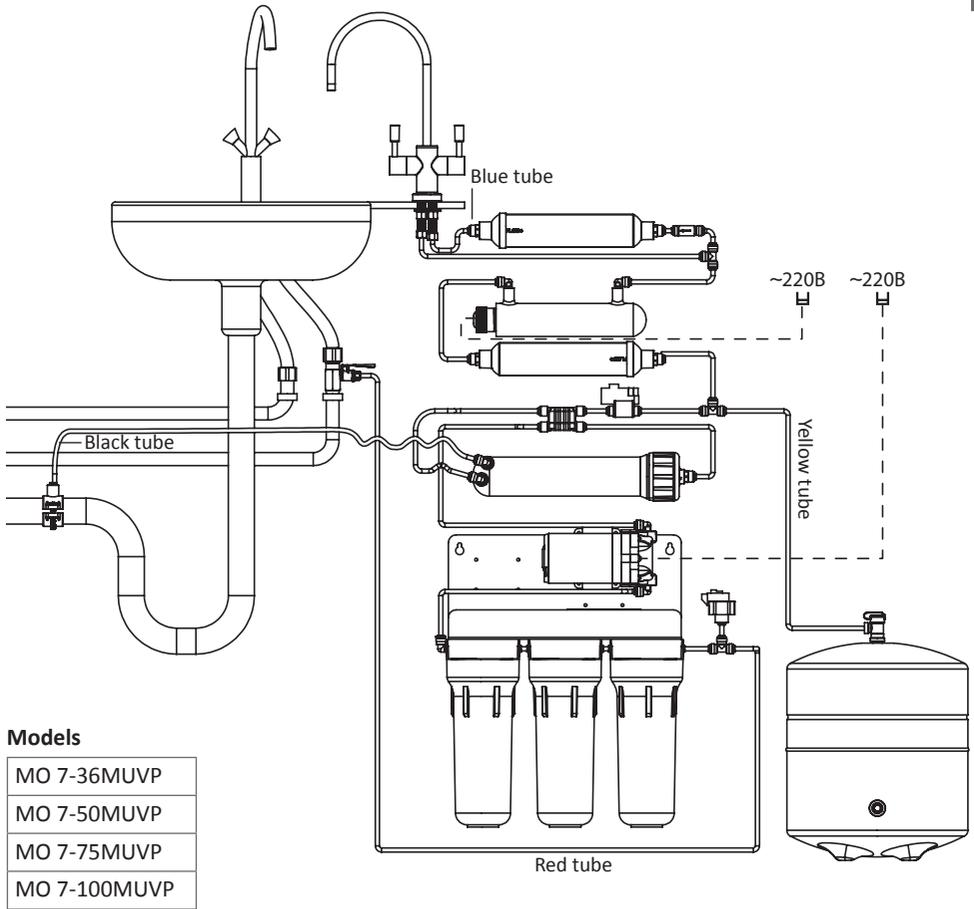

The manufacturer reserves the right to modify product design or specific components, if such modification does not entail deterioration of consumer properties of the product.

3. CONNECTION DIAGRAMS

3.9A. CONNECTION DIAGRAM FOR UNIT P'URE WITH SINGLE LEVER FAUCET

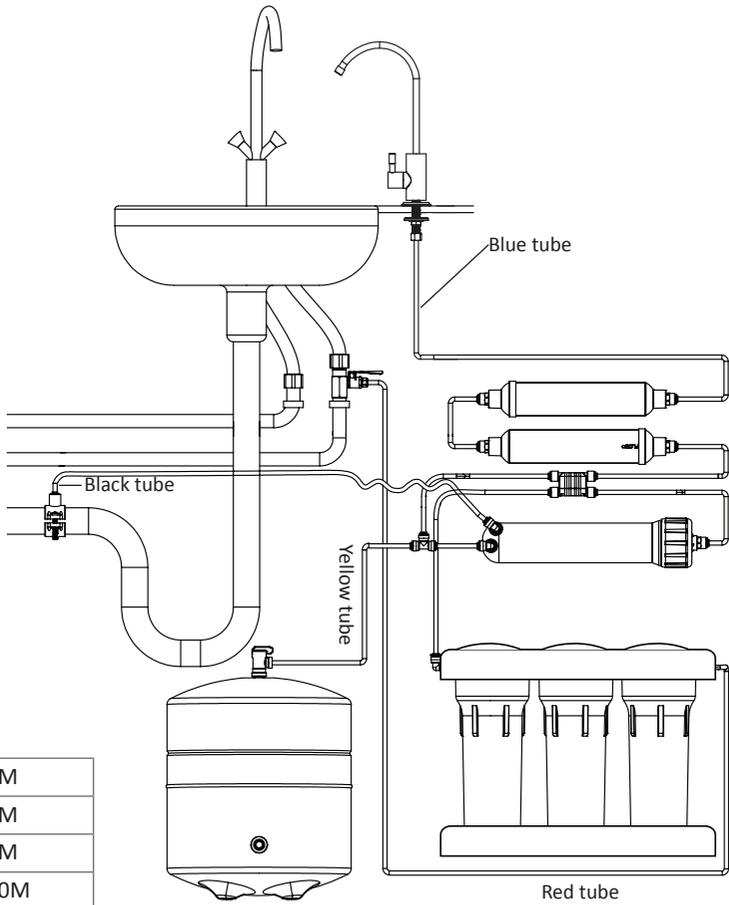

Models

MO 6-36M
MO 6-50M
MO 6-75M
MO 6-100M

The manufacturer reserves the right to modify product design or specific components, if such modification does not entail deterioration of consumer properties of the product.

3. CONNECTION DIAGRAMS

3.9B. CONNECTION DIAGRAM FOR UNIT P'URE WITH DOUBLE LEVER FAUCET

ENG

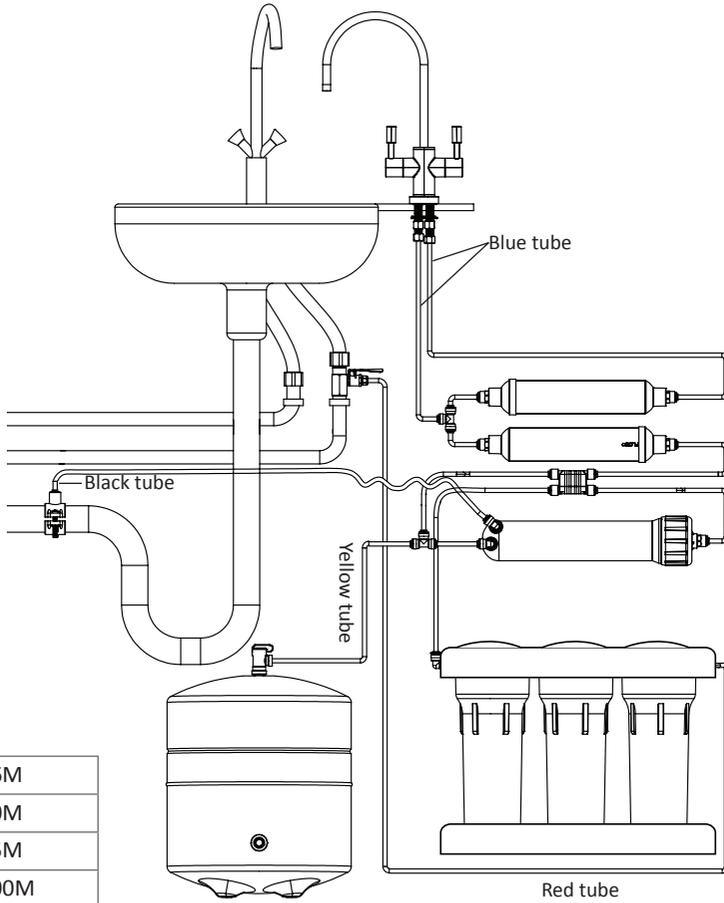

Models

MO 6-36M
MO 6-50M
MO 6-75M
MO 6-100M

The manufacturer reserves the right to modify product design or specific components, if such modification does not entail deterioration of consumer properties of the product.

3. CONNECTION DIAGRAMS

3.9C. CONNECTION DIAGRAM FOR UNIT P'URE AQUACALCIUM

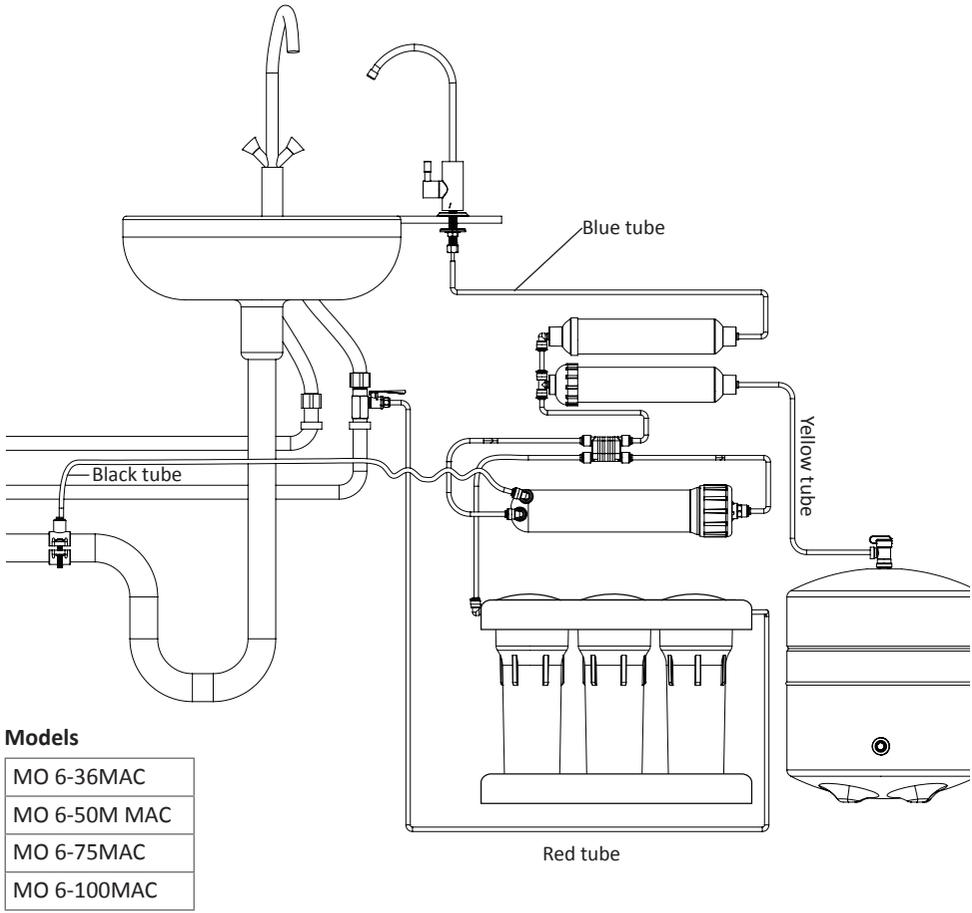

Models

MO 6-36MAC
MO 6-50M MAC
MO 6-75MAC
MO 6-100MAC

The manufacturer reserves the right to modify product design or specific components, if such modification does not entail deterioration of consumer properties of the product.

4. STEPS FOR INSTALLING REVERSE OSMOSIS SYSTEM

Before installing a domestic reverse osmosis filter please carefully read this instruction. This system must be installed in compliance with local codes.

4.1. BEFORE COMMENCING INSTALLATION

- 1) Check that all parts are in the package. Do not open the plastic bags with filter parts before you make sure everything is in place to be able to return faulty/incomplete package.
- 2) Check conformity of your local variables to requirements specifications:

Main pressure*	Tank pressure*	Supply water temperature*
Check water pressure at mains before installing the product. Compare to the requirements in paragraph 2.2.	Check pressure in the tank bladder. Compare to the requirements in paragraph 2.2.	Check temperature of supply water. Compare to the requirements in paragraph 2.2.
*Refer to paragraph 2.2 for recommended measures in case any of the above variables does not meet the requirements.		

- verify that your product is as specified in paragraph 2.2;
 - verify that your supply water quality** meets the requirements in paragraph 2.3.
- **If supply water quality does not meet the requirements, it is necessary to consult with a water treatment specialist.

- 3) Before installing the system, make sure there is enough space for both the filter rack and the pressure tank under the sink. In case there is not enough available space, pressure tank can be placed in a separate location provided that the yellow tube's length is sufficient to connect it to the rest of the system.
- 4) **Electrical safety notice:** This appliance should be connected into a circuit with an RCB installed
- 5) Install the system per the guidelines of this manual.

4.2. INSTALLATION PROCEDURE

CAUTION! This system has been tested by the manufacturer for leaks, so within the system the presence of residual water is allowed.

Wash your hands thoroughly with anti-bacterial soap before handling tubes, cartridges, and membrane.

This system should desirably be installed in places protected from direct sunlight and away from heating appliances.

1.	Remove the reverse osmosis system from its packaging and check the equipment. Do not open the bag with components. Note that you will not be able to claim missing parts if the bag is opened.
2.	Shut off water supply in your kitchen or whole home and open water tap where you are about to install the system (on your kitchen sink) for 1 minute to relieve pressure in the system, and then close it.

4. STEPS FOR INSTALLING REVERSE OSMOSIS SYSTEM

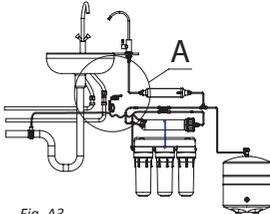
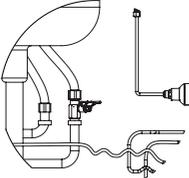
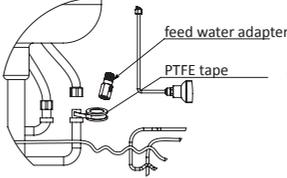
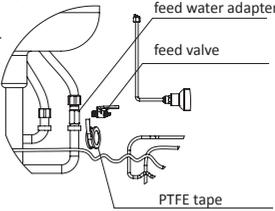
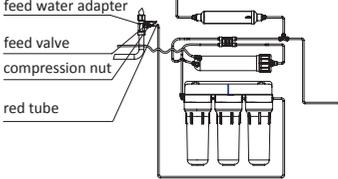
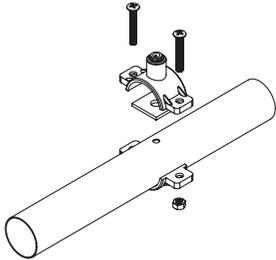
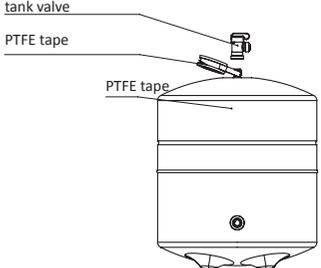
<p>3.</p>	<p>Screw the feed water adapter 4 into the cold water plumbing. Screw the feed valve 5 into the feed water adapter 4. To help prevent water leaks use PTFE sealing tape.</p> <p>Connections size is selected to fit most common size ½ inch pipe. If your pipe is of another size, prepare an appropriate adapter.</p>	
<p><i>Fig. A1</i></p> 	<p><i>Fig. A2</i></p> 	<p><i>Fig. A3</i></p> 
<p>4.</p>	<p>Unscrew the compression nut from the feed valve 5 and put it on the red tube. Push the red tube on the end of feed valve's fitting and screw on the compression nut. Connect the free end of the red tube with the quick connect fitting of the first (rightmost) housing in the rack.</p>	
<p>5.</p>	<p>Connect the drain saddle 8 with drain pipe from the kitchen sink. The drain saddle is compatible with most standard drain pipes. Drill a hole of 5.0 mm (0.2") diameter in the kitchen sink drain pipe, apply rubber gasket with sticky base (included in the package). Install the drain saddle 8 on the drain pipe over the hole. Tighten screws on drain saddle with a screwdriver. Insert black tube into the connection on the clamp (figure 4). Connect the other end of the black tube with concentrate outlet of membrane housing.</p> <p>CAUTION! Check if the flow regulator 12 is installed in the black tube in the end connected to membrane housing.</p>	
<p>6.</p>	<p>Add 5-6 wraps of PTFE tape to tank knob and hand tighten tank valve – do not overtighten, which may cause damage. Close the tank valve.</p> <p>IMPORTANT! Check air pressure in empty tank. Tank should be pressurized to 0.4-0.6 bar (5.8-8.7 psi). If necessary, use a pump with a pressure gauge to increase the pressure or push the core of the valve stem to relieve pressure.</p>	

4. STEPS FOR INSTALLING REVERSE OSMOSIS SYSTEM

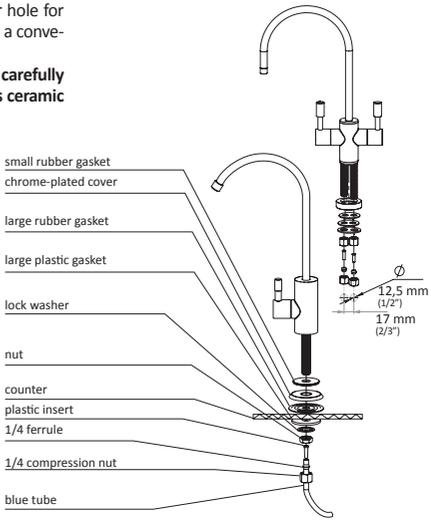
7.	<p>Installation of the faucet.</p>
7.1	<p>To install drinking water faucet 3 drill 12.5 mm (1/2") diameter hole for single way tap or 17 mm (2/3") diameter hole for two way tap in a convenient location at the sink or countertop.</p> <p>Caution! metal shavings can damage your unit, remove them carefully as soon as you have drilled the hole. If the mounting surface is ceramic or stone, you may need a special carbide drill.</p>
7.2	<p>Mount the faucet on the sink or countertop as shown on the figure. Nut, lock washer and plastic washer on the faucet shank must fix the faucet firmly on the surface.</p>
7.3	<p>Take the blue tube, put on compression nut, ferrule, and put plastic insert inside, in that order.</p>
7.4	<p>Push the blue tube as deeply as possible into the bottom of the faucet's shank, ensuring the compression ring is in the joint. Screw on the compression nut in order to join the tube to the faucet.</p>
7.5	<p>Installation of the double lever faucet (for a system with mineralizing post-filter) is done similarly.</p>
 <p>The diagram shows a faucet being installed on a surface. Labels point to the following parts: small rubber gasket, chrome-plated cover, large rubber gasket, large plastic gasket, lock washer, nut, counter, plastic insert, 1/4 ferrule, 1/4 compression nut, and blue tube. Dimensions are indicated: a hole diameter of 12.5 mm (1/2"), a hole diameter of 17 mm (2/3"), and a distance of 272 mm (10.7") between the filter housings.</p>	
8.	<p>Select spot where you are going to install the filter and make two holes. The distance between the holes in the wall must precisely correspond to that between the holes in the bracket. Allow for at least 100 mm (3.9") gap between the bottom of the filter and floor. Install screw anchors if necessary and screw in two screws (not included). The distance between the holes is 272 mm (10.7").</p>
9.	<p>Insert cartridges into the first and the second housings in the direction of water flow (leftwards).</p>
10.	<p>Tighten all the three sumps by hand.</p>
11.	<p>Unplug the tube that connects the third housing (in the direction of water flow) with the auto shut-off valve from the valve.</p>

4. STEPS FOR INSTALLING REVERSE OSMOSIS SYSTEM

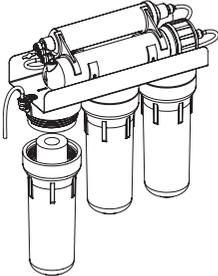
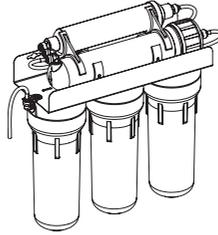
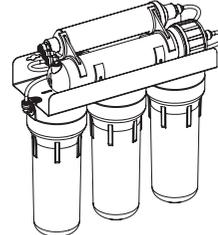
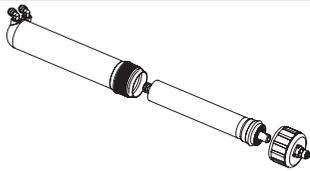
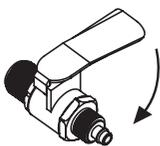
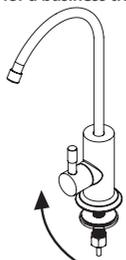
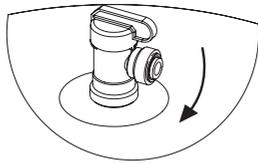
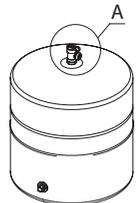
12.	<p>Open the water tap 5 and let through the first two pre-filters with cartridges 5-7 liters (1.5-2 gallons) of water to wash off the carbon fines (black in colour) that may appear in cartridges during shipping. Then close feed water valve before installing the third cartridge.</p> <p>CAUTION! This water will pour through the tube disconnected from auto shut-off valve, prepare a vessel to collect it.</p>
13.	<p>Insert the cartridge into the third sump along water flow direction and attach the sump back again. Connect the free end of the tube back to the auto shut-off valve.</p> <div style="display: flex; justify-content: space-around; align-items: center; margin-top: 10px;">    </div>
14.	<p>Install the membrane 11 into the membrane housing.</p> <p>CAUTION! Cut the plastic bag to install the reverse osmosis membrane. Install the membrane without first unpacking it by pushing it into the housing directly from the bag. Avoid touching the membrane and only hold it covered with the bag.</p> <div style="text-align: right; margin-top: 10px;">  </div>
15.	<p>Leave the feed valve 5 and purified water faucet 3 open for 30 minutes. Then open the tank valve 6. Close the faucet 3 and carefully check all connections for leaks.</p> <p>CAUTION! The first week after installation, check the system daily for leaks, do it periodically in the future. If you are leaving for a long time such as for a business trip or vacation, shut off the water supply.</p> <div style="display: flex; justify-content: space-around; align-items: center; margin-top: 10px;">   <div style="text-align: center;"> <p>A (1 : 1)</p>  </div>  </div>
16.	<p>Let the water tank get filled (you will hear the water stop flowing). Depending on the water pressure in your water mains may take 1.5 to 3 hours. After that drain all water from the tank by opening the faucet 3 until the flow goes to a drip or slow dribble. After the tank has been emptied, close the faucet 3 so that the tank starts re-filling. Depending on the pressure in your water mains, it may take 1.5 to 3 hours. After the tank is filled for the second time, you can use purified water.</p>
17.	<p>Initially your water may appear cloudy which is due to air in the system. If you leave the glass of water for a few minutes, the water will become clear as the air escapes. This is normal and will eventually clear as the air is eventually flushed out of the filters.</p>

5. STEPS AFTER INSTALLATION

VERIFICATION OF THE UNIT'S OPERATING PARAMETERS

1. Measure time needed to fill the tank. Tank is filled when the dumping of the concentrate into the drain has stopped. The value obtained is dependent on the supply water pressure (pressure in water mains).
2. Measure recovery (proportion of supply water that becomes purified). You will need 1 L (1 quart) measuring cup and a stopwatch.
Shut off tank valve 6, open faucet 3 and measure time that the unit takes to produce 1 L (1 quart) of permeate (purified water), then close faucet 3. Write down the result (t_{Permeate} in the equation below).
Disconnect the black tube connected to sink drain from drain saddle. Open faucet 3 and measure time that the unit takes to produce 1 L (1 quart) of concentrate (waste water), then close faucet 3 and open tank valve 6. Write down the result ($t_{\text{Concentrate}}$ in the equation below). Calculate recovery using formula:

$$R, \% = \frac{t_{\text{Concentrate}}}{t_{\text{Permeate}} + t_{\text{Concentrate}}} \times 100\%$$

Where t is the number of seconds to obtain 1 L (1 quart) of water, R is recovery.

3. Measure TDS of supply water and TDS of purified water using a calibrated TDS meter.
4. Check if the auto shut-off valve functions properly. Close tank valve 6 and faucet 3. The unit must stop operating (water should stop being discharged to drain) within 10 minutes.
5. Check the unit for leaks.
6. Advise unit owner on filter maintenance and encourage to read this manual.
7. Make record of commissioning in the maintenance log in paragraph 9 of this book.

6. USAGE

Domestic reverse osmosis system is designed for purification of cold water only. If the filling time of the tank increased, this means that the pre-filter cartridges are worn out and should be urgently replaced. Delay in the replacement of cartridges can lead to deterioration or destruction of the membrane. To avoid such critical situations, it is strongly recommended that you **change pre-filter cartridges at least once every 3 months**. If the rate of filtration drops significantly and is not helped by replacing pre-filters, you need to replace reverse osmosis membrane. To enjoy purified water of consistent quality, it is recommended **to replace the membrane at least once in 1-1.5 years**. In case of prolonged downtime (2 weeks or more), it is necessary to sanitize the system as described in paragraph 7. If you plan on leaving for an extended while, it is recommended to shut off the water supply.

6. USAGE

6.1. PARTS OF THE FILTER AND THEIR RECOMMENDED CHANGE OUT RATES

Stage of filtration	Name of cartridge	Term for replacement
first	Pre-filter cartridges for reverse osmosis feed water pre-treatment. Life of cartridges depends on quality of supply water and daily consumption of purified water.	At least once in 3 months
second		
third		
fourth	Reverse osmosis membrane	Once a year
fifth	Carbon post-filter	
sixth	Mineralizing post-filter/UV lamp	

6.2. THE PROCEDURE FOR REPLACING PRE-FILTER CARTRIDGES

1.	Shut off feed valve 5 and tank valve 6 .
2.	Wash your hands with antibacterial soap.
3.	Unscrew with the sump wrench 10 first and second sumps in water flow direction (right to left). Be careful as the sumps are filled with water.
4.	Remove the used filter cartridges.
5.	Wash sumps with unflavored soap and a clean sponge, then rinse thoroughly with water.
6.	Insert the new cartridges in the first and second sumps by water flow direction.
7.	Disconnect the tube stemming from the third sump from the auto shut-off valve.
8.	Open the feed valve 5 and let through the first two installed cartridges 5-7 liters (1.5-2 Gallons) of water to rinse the coal dust that may be produced in cartridges during shipping. CAUTION! This water will pour through the tube disconnected from auto shut-off valve, prepare a vessel to collect it.

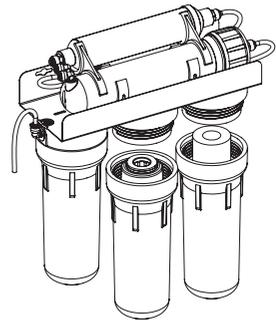

6. USAGE

ENG

- 9. Remove the third pre-filter's sump from filter head. Be careful as it is filled with water.
- 10. Remove the used filter cartridge and wash the sump with unflavored soap and a clean sponge, then rinse thoroughly with water.
- 11. Insert new cartridge into the third sump. Screw the sump back on and let through at least 4 more liters of water to flush the coal dust. Close the feed valve **5** and connect the previously separated tube with the auto shut-off valve.

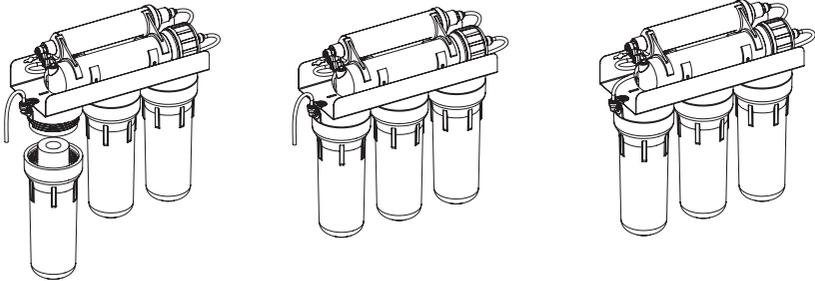

- 13. Open the tank valve **6**.
- 14. Open the feed valve **5**.

6. USAGE

6.3 THE PROCEDURE FOR REPLACING MEMBRANE

(membrane replacement should be performed by a qualified specialist)

1.	Turn off water supply to the system (feed valve 5), shut off the tank valve 6 .
2.	Open the purified water faucet 3 to relieve permeate pressure.
3.	Disconnect the white tube from the inlet in membrane housing cap.
4.	Unscrew the membrane housing cap.
5.	Remove the used reverse osmosis membrane 11 (remember which end of the membrane goes where).
6.	Lubricate rubber seals of the fresh replacement membrane and membrane housing cap sealing. CAUTION! To avoid damage to the membrane, only use food grade glycerol as lubricant.
7.	Install the fresh membrane into the housing, observing its direction and position of the tube. CAUTION! Cut the plastic bag to install the reverse osmosis membrane. Install the membrane without first unpacking it by pushing it into the housing directly from the bag. Avoid touching the membrane and only hold it covered with the bag.
8.	Screw on the housing cap.
9.	Connect the white tube to the membrane housing inlet.
10.	Close drinking water faucet 3 .
11.	Open the tank valve 6 .
12.	Open the feed valve 5 .
13.	Once the tank is full (you will hear the water stop flowing), drain all water from the tank into the sink by opening faucet 3. When the water stops running, close the purified water faucet 3 so that the tank starts to re-fill. Depending on the pressure in your water mains, filling may take 1.5 to 3 hours. After the second tank re-fill, you can safely use the purified water.

6. USAGE

ENG

6.4 THE PROCEDURE FOR REPLACING CARBON POST-FILTER AND/OR MINERALIZING POST-FILTER

1.	Turn off water supply to the system (feed valve 5), shut off the tank valve 6 .
2.	Open the purified water faucet 3 to relieve permeate pressure.
3.	Disconnect the tubes that connect the carbon post filter / mineralizing post-filter to the rest of the system (remember which goes where).
4.	Remove the used carbon post-filter / mineralizing post-filter from clip brackets.
5.	Install new carbon post-filter / mineralizing post-filter, guided by arrows that indicate the direction of water flow.
6.	Connect the tubes to the new carbon post-filter / mineralizing post-filter to connect it to the system.
7.	Open feed valve 5 . Open tank valve 6 .
9.	Once the tank is full (you will hear the water stop flowing), drain all water from the tank into the sink by opening faucet 3 . When the water stops running, close the purified water faucet 3 so that the tank starts to re-fill. Depending on the pressure in your water mains, filling may take 1.5 to 3 hours. After the second tank re-fill, you can safely use the purified water.

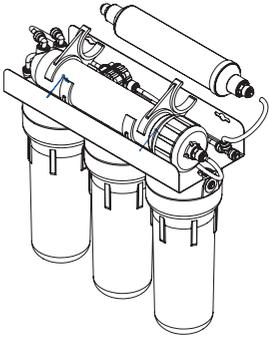

6.5 THE PROCEDURE FOR REPLACING UV LAMP
 (UV lamp replacement should be performed by a qualified specialist)

Recommended life of the UV lamp is 9000 hours (approximately 1 year of continuous operation).

CAUTION!

Using UV lamp beyond the recommended service life is disapproved, since the intensity of UV radiation and its germicidal efficiency will be reduced.

It is strongly forbidden to turn on the UV lamp power when the lamp is not in metal housing, and to look at a glowing lamp. This can lead to eye damage and result in deterioration or loss of vision.

When replacing the UV lamp, it is advisable to clean the quartz sleeve. Do not use abrasive materials to clean the sleeve, as this may decrease transparency of the sleeve to UV radiation, thereby reducing the efficiency of disinfection. Be careful when removing the quartz sleeve from the housing to avoid damaging or scratching the sleeve.

6. USAGE

Use care when removing sealing rings from the ends of the sleeve. The rings serve to protect the lamp and electrical connections from water leaks.

UV lamps should be handled with care and only held by the ceramic ends, because contaminating the quartz surface will reduce germicidal efficiency and shorten service life. Use cotton gloves while handling UV lamps.

1.	Disconnect the UV lamp from the power supply.
2.	Shut off the feed valve 5 and tank valve 6 .
3.	Remove the black PVC end cap with wire hole.
4.	Remove the lamp from the quartz sleeve by pulling on its base. Do NOT touch the bulb!
5.	Disconnect the power connector holding the lamp by its base.
6.	Insert the new lamp half way into the quartz sleeve.
7.	Properly connect the power connector.
8.	Push the new lamp all the way into the housing and put the PVC cap on its end.
9.	Restore the water supply to the unit and check if tightness of quartz sleeve sealing has not been disrupted during lamp replacement.
10.	Plug UV lamp adapter in a socket and verify that the new UV lamp is functioning properly. This will be confirmed by continuous green LED light on the adapter.

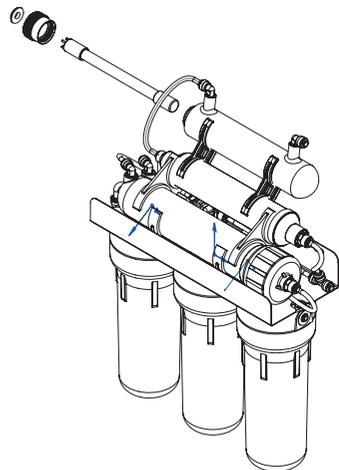

7. SANITIZATION OF REVERSE OSMOSIS FILTER

Sanitization of the reverse osmosis filter is recommended after it has been in use for an extended period (~ 6 months), and when the filter is not going to be used for 3 or more weeks at a time. It is also desirable to sanitize the system when replacing cartridges.

Using chlorine disinfectant tablets is recommended for reverse osmosis filter sanitization.

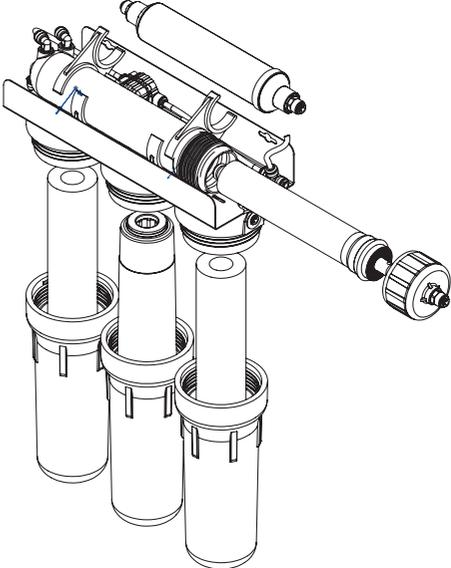
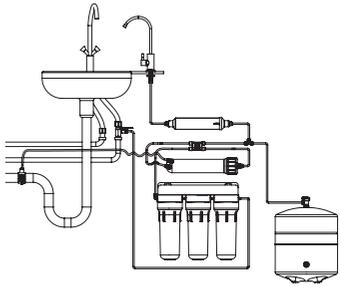
1.	Shut off feed valve 5 and tank valve 6 .
2.	Remove and discard the pre-filter cartridges and carbon post-filter.
	
3.	Unscrew cap of membrane housing and remove membrane using needlenose pliers if necessary. Put the membrane into a tight bag and store in refrigerator at +2...+5°C (36...41 °F).
4.	Screw back on 2 nd and 3 rd pre-filter sumps, screw on membrane housing cap, and connect the tube from the faucet directly to the union tee without carbon post-filter.
	

7. SANITIZATION OF REVERSE OSMOSIS FILTER

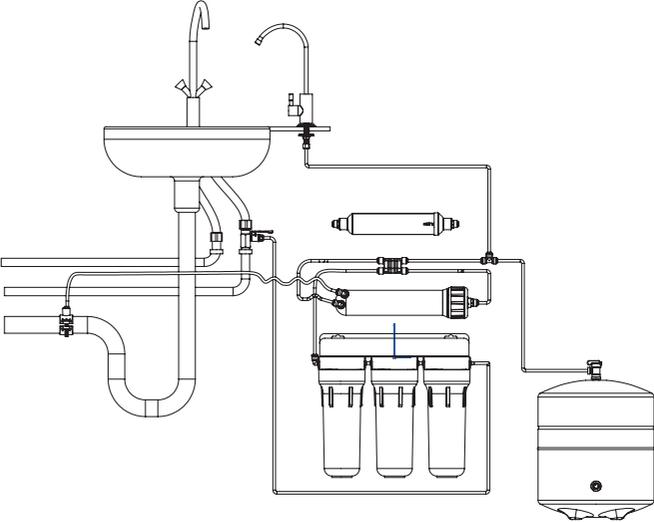
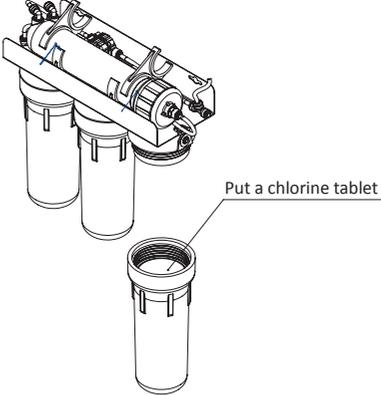
<p>4.</p>	
<p>5.</p>	<p>Put a chlorine tablet in the 1st sump. Fill the sump with water and screw on.</p> 
<p>6.</p>	<p>After 15 minutes, open the drinking water faucet 3 and feed valve 5.</p>
<p>7.</p>	<p>When water running from the faucet 3 starts to smell like chlorine, close both the faucet 3 and feed valve 5.</p>
<p>8.</p>	<p>Leave the system for 2-3 hours.</p>
<p>9.</p>	<p>Open faucet 3 and feed valve 5 and let water run until bleach odor is gone.</p>
<p>10.</p>	<p>Install all consumable parts back into the system. Open tank valve 6 and feed valve 5.</p>
<p>11.</p>	<p>Drain the tank and re-fill for at least two times (until chlorine odor cannot be smelt).</p>

7. SANITIZATION OF REVERSE OSMOSIS FILTER

ENG

7.1 SANITIZATION OF PRESSURE TANK

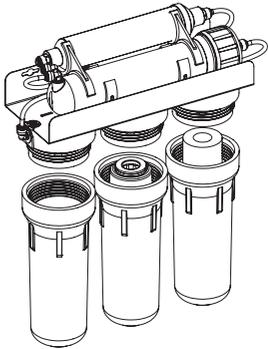
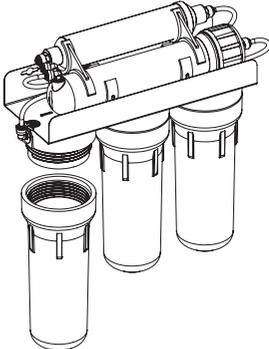
1.	Turn off feed valve 5 .
2.	Open the faucet 3 and empty the pressure tank in the drain.
3.	Shut tank valve 6 .
4.	<p>Extract pre-filter cartridges.</p> 
5.	<p>Install 2nd and 3rd sumps (by water flow direction) back on filter.</p> 

7. SANITIZATION OF REVERSE OSMOSIS FILTER

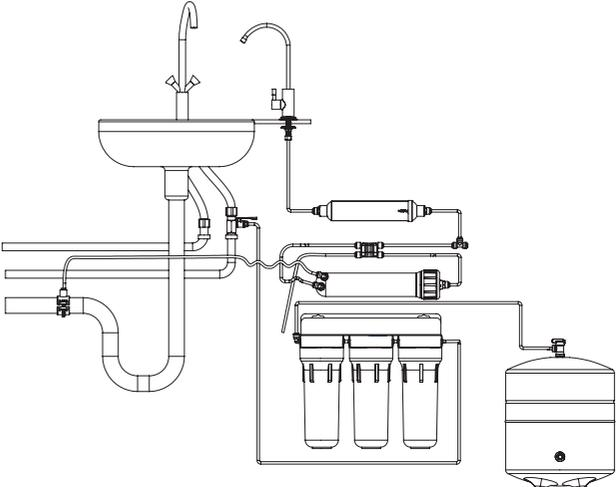
<p>6.</p>	<p>Disconnect the tube going to the storage tank from the union tee before the carbon post-filter, and into 3rd pre-filter's outlet.</p> 
<p>7.</p>	<p>Put a disinfection tablet in the 1st sump. Fill the sump with water and screw on.</p>
<p>8.</p>	<p>After 15 minutes, open tank valve 6.</p>
<p>9.</p>	<p>Open the feed valve 5 for 5 minutes.</p>
<p>10.</p>	<p>Close the tank valve 6 and leave the tank filled with chlorine solution for 1-2 hours.</p>
<p>11.</p>	<p>Open tank valve 6 and drain all water from the tank to the sink. Disconnect it from the third pre-filter and restore the original tubing of the system.</p>
<p>12.</p>	<p>Put cartridges in sumps and install the sumps on their heads. Then, open tank valve 6 and feed valve 6.</p>
<p>13.</p>	<p>Drain the tank and re-fill for at least three times (until chlorine odor cannot be smelt).</p>

8. TROUBLESHOOTING

PROBLEM	CAUSE	SOLUTION
Fitting leak	Tube is not joined tightly	Remove and rejoin the tube
Drain saddle leak	Drain saddle is not installed properly	Reinstall drain saddle as described in paragraph 4.2 in this manual
Pre-filter sump leak	O-ring seal is lacking or misaligned	Check that the O-ring seal is properly aligned in the groove inside sump
	Sump is not joined tightly	Tighten the sump till snug
Water runs too slowly from the faucet or slows down substantially a few seconds after the faucet is opened	Water supply pressure too low	This RO system requires at least 3 bar to function properly. If necessary, install a pressure booster pump or consult a plumber
	Pre-filter cartridges are clogged	Replace pre-filter cartridges
	Membrane is clogged	Measure permeate flowrate by closing tank valve 6 and opening faucet 3. Use a measuring cup to check if the time it takes to produce 1 L drinking water is as follows: – 8 minutes with 50 gpd membrane; – 5-6 minutes with 75 gpd membrane; – 4 minutes with 100 gpd membrane. If it took twice as long or more to produce 1 liter of water, the membrane may need to be replaced (refer to the store where you bought this product)
	A tube is kinked	Straighten the tube
	Pressure tank is deflated	Pressure in the empty tank should be 0.4-0.6 bar (6-9 psi). Charge the tank to the above pressure
High noise	Air in the auto shut off valve	The air will go away by itself with continued operation of the system
	Water supply pressure too high	Check your water supply pressure. If necessary, install a pressure regulator or refer to a plumber

8. TROUBLESHOOTING

Auto shut-off valve knocks	Pressure surges in water mains	Install a check valve on the main pipe in your kitchen or at the point of entry of your home's water supply. Refer to a plumber.
The system is always on (water is drained continuously)	Water supply pressure too low	This RO system requires at least 3 bar (44 psi) to function properly. If necessary, install a pressure booster pump or consult a plumber
	Pre-filter cartridges are clogged	Replace pre-filter cartridges
	Membrane is clogged	Measure flow of product water by closing the tank valve and opening the faucet. Measured flow rate should correspond to nominal membrane flow rate.
	Missing or misplaced flow restrictor	Flow restrictor must be installed in the tube running from membrane housing to drain. Flow restrictor must face membrane housing. If it faces drain saddle fitting, clean it and swap ends of the tube so that it is placed at the outlet of membrane housing. If flow restrictor was not installed, install one.
	Failure of auto shut-off valve	The RO system operating ceaselessly while the tank is full may be due to automatic shutoff valve failure. Contact the store where you bought this product if no other possible cause can be established
	Failure of check valve in the transition fitting installed at membrane housing permeate outlet	Pressure in the empty tank should be 6-9 psi (0.4...0.6 bar). Charge the tank to the above pressure if necessary
	Pressure tank is deflated	Open drinking water faucet and let some water out. It is normal for the system to stand idle when the pressure tank is full of water.
The system will not turn on (no water runs to sink drain)	Pressure tank is full	Open drinking water faucet and let some water out. It is normal for the system to stand idle when the pressure tank is full of water.
	Flow restrictor is clogged	Clean or replace flow restrictor
	Drain saddle fitting is not centered on drain pipe hole	Correctly position the drain saddle

8. TROUBLESHOOTING

ENG

<p>Drinking water has a milky or cloudy appearance that goes away after a few minutes</p>	<p>Air in the system</p>	<p>Some air in the system is normal for a few days after the system was installed. In some cases, air bubbles may appear due to supply water being significantly lower temperature than your home's ambient temperature</p>
<p>Water has a taste and/or odor</p>	<p>Carbon post-filter has expired</p>	<p>Replace the post-filter</p>
	<p>Preservative solution in the membrane has not been flushed out</p>	<p>Drain all the water from the tank and let the system re-fill it</p>
	<p>Contamination in reverse osmosis system</p>	<p>Sanitize the system per instructions in section 7</p>
	<p>Contamination in pressure tank</p>	<p>Replace the tank or sanitize per instructions in paragraph 7.1</p>
<p>Pressure tank holds too little water</p>	<p>Tank bladder is overpressurized</p>	<p>Pressure in empty tank should be 0.4-0.6 bar (6-9 psi). Make sure pressure in your tank is in line with the above figures</p>
<p>No water is dispensed from faucet albeit tank is full</p>	<p>Tank bladder is underpressurized</p>	<p>Pressure in empty tank should be 0,4-0,6 bar (6-9 psi). Make sure pressure in your tank is in line with the above figures</p>
	<p>Tank valve is closed</p>	<p>Open tank valve</p>

9. SERVICE RECORD

Manufacturer strongly recommends to keep record of your system's operation. Information recorded in this log will help specialists carry out maintenance or repair if needed. Also, this information can be requested by the manufacturer in case any malfunctions are encountered.

COMMISSIONING

Commissioning date, DD: MM: YY	
Main pressure	
Sanitization performed, YES / NO	
TANK FILL DURATION, HH: MM	
Recovery, %	
Recommendations	
Further information about installed equipment: name, date of installation (Example: pressure regulator, pump, POE water filter etc.)	
Seller's identity	
Installer's identity	

Installation works were completed. The product was tested and is fully functional. No claims as to product quality and/or installer's performance were encountered.

Owner _____ Signature / Name

Installer _____ Signature / Name

9. SERVICE RECORD

MAINTENANCE LOG

Type of job					
Consumables used for the job: product, date of manufacture, serial number (example: cartridges, membrane)					
Sanitization performed, YES / NO					
Tank fill duration, HH: MM					
Recovery, %					
Recommendations					
Date of maintenance, DD: MM: YY					
Servicing company name					
Installer's name					
Servicing company contact information					
Signature					

10. ENVIRONMENTAL AND HEALTH SAFETY

The product does not have any chemical, radiological, electrochemical impact on the environment. The product is not regarded as hazardous by their impact on the human body, meets requirements of relevant sanitary legislation for its intended scope of use.

11. PURCHASING

Desirably, the product should be purchased from authorized sales establishments. When buying, check integrity of packaging, absence of mechanical damage and other defects, contents of the system (without opening the plastic bags), availability of user documentation, particularly this manual and warranty card.

12. TRANSPORTATION AND STORAGE

Shipping of the product may take place by any means of transport (except unheated during cold seasons in colder climates) in accordance with the rules of transportation of goods, applicable to each type of transport. Observe handling labels when handling and shipping the product. Product should be stored indoors with protection from mechanical damage, impact of moisture and aggressive chemicals. Store this product in the manufacturer's original packaging at ambient temperatures ranging from 5 °C to 40 °C (from 41 °F to 104 °F) and relative humidity up to 80%, at least 1 m (3.3 ft) away from heating equipment.

13. WARRANTY

We thank you for purchasing a reverse osmosis product by Ecosoft Company.

We hope that this product will serve you long and let you and your family enjoy high quality pure drinking water. The manufacturer guarantees that the water purification system does not contain workmanship defects and no such defects will arise within warranty period from the date of purchase from store provided that the technical requirements and operating conditions specified in this manual are strictly adhered to.

To avoid misunderstanding, we urge you to carefully read the instructions on installation and operation of the reverse osmosis system, warranty conditions liabilities, check correctness of the warranty card, presence of proof of purchase (receipt, invoice, or bill). Warranty card is valid only if model, date of purchase, and stamp of selling establishment are correctly specified. For proper installation details please read instructions on how to install and use or seek help from a qualified professional.

The manufacturer is not liable for any damage to property or some other damage, including lost profits, which arose by chance or due to use or inability to use this product. Manufacturer's liability in accordance with this warranty is limited to the cost of the filter.

The warranty does not cover:

- replaceable elements (cartridges, reverse osmosis membrane, carbon post-filter, mineralizing post-filter or other consumables included in the package);
- electrical equipment in ungrounded electrical systems or lack of voltage regulator where it is required;
- components that require replacement because of normal wear and tear;
- faults and problems that have arisen due to untimely replacement of consumable elements where there intervals are provided in this manual, and also due to use of other manufacturers' consumables.

All claims related to taste, smell, and other quality indicators of water purified by this system should only be filed with a water test report issued by an accredited laboratory.

Cases not covered under this warranty shall be resolved in accordance with local legislation.

NOTES