

INTEWA



BELGAQUA



RAINMASTER Eco

Installation and user manual

WATER, WE'RE IN OUR ELEMENT

1. Introduction and scope of application	2
1.1 Modes of operation.....	3
2. Safety instructions.....	4
3. Scope of delivery	5
4. Technical data	6
4.1 Device overview and dimensions.....	8
4.2. Dimensioning of the intake line	9
4.3 Standards, directives, tests	10
5. Overview of components	11
5.1 Components of basic controller	11
5.2 Components of diaphragm pump.....	12
5.2.1 Membranpumpe.....	12
5.2.2 Fan.....	12
5.3 Components of the supplemental supply container.....	12
5.4 Components of electronic 3/2-way ball valve.....	13
5.5 Components of the pressure line set.....	13
6. Installation instructions for RAINMASTER Eco.....	15
6.1 Wall mounting.....	15
6.2 Connection to the mains water line.....	16
6.3 Installation on the intake side.....	17
6.3.1 Installation of a protective conduit pipe.....	17
6.3.2 Layout of the intake line	18
6.3.3 Intake line connection.....	19
6.3.4 Installation of the floating intake.....	19
6.4 Installation of the pressure line set	20
6.5 Connecting the emergency overflow	21
6.6 Installation and adjustment of the float switch.....	22
7. Start up and use	23
7.1 Start-up in mains water mode.....	23
7.2 Start-up in rainwater mode.....	24
7.3 Modes of operation and display.....	25
7.3.1 Automatic mode (Switch position I).....	25
7.3.2 Maintenance mode (Switch position II).....	25
8. Trouble shooting in case of problems	26
9. Maintenance	28
10. Spare parts	29
11. Optional accessories.....	29
12. Guarantee.....	30
13. Contact / Device number	31

1. Introduction and scope of application

Congratulations on purchasing your **RAINMASTER Eco (RM Eco)**.

The *RM Eco* is specially designed for rainwater and greywater harvesting in single family dwellings. Optimised for the water requirements of small families, and using diaphragm pump technology, the *RM Eco* is the first rainwater module to offer up to 70 % lower power consumption when compared to conventional rainwater modules.

The RM Eco is compatible with the following combinations:

Toilet / Urinal:

You can connect up to three toilets and one urinal.

Note:

The maximum installation height for toilets and washing machines, above the RM Eco control unit, is 6 m. The filling time of toilet cisterns increases with the simultaneous flushing of 2 or more toilets. If a urinal is used in parallel to other toilets, then the flow pressure may not always be sufficient.



Washing machine:

You can connect up to two washing machines.

Note:

If more than one washing machine is connected, or at the same time for example, the garden is being watered, then depending on the type of washing machine used, your supply may be interrupted if the water does not fill fast enough. In that case, you may have to start the washing machine with a time-delay.



Garden / Cleaning:

For small watering and cleaning tasks, a garden tap can be connected.

From this, the following garden consumers may be supplied:

- a 20 m garden hose with spray nozzle, or
- a small lawn sprinkler - up to 2bar (29psi) / 500 l/h RM Eco10
- a high pressure cleaner - up to 500 l/h RM Eco 10

Note:

- A drip irrigation system needs special dimensioning in combination with an expansion vessel.



1.1 Modes of operation

Automatic mode

In Automatic mode, the diaphragm pump supplies rainwater from the tank into the home and to respective consumers (e.g. toilets etc.). If the tank is empty, this is then detected by the float switch in the tank which instructs the electronic 3/2-way motorised ball valve to change to the mains water mode. The suction line is then cut-off and the required mains water is taken from the built-in supplemental supply container within the *RM Eco*. When the rainwater tank is filled again with rainwater, the float switch detects this and the electronic 3/2-way motorised ball valve switches back to the rainwater mode.

Maintenance mode

In Maintenance mode, the 3/2-way ball valve switches permanently to mains water mode, where the consumer is continuously supplied from the supplemental supply container.

In both modes, the power on and off of the diaphragm pump is done by means of the built-in pressure switch. The anti-dry running protection of the diaphragm pump, and the stagnation protection of the supplemental water supply (the regular refreshing of water in the supplemental supply) are automatically controlled by the unit's built-in controller.

An optional fill level status indicator (RM Eco-FS) or an external charging pump (RM Eco-LP) for boosting water intake can be connected to the unit.

1. Rainwater unit RAINMASTER Eco
2. Mains water connection
3. Pressure line set with expansion tank
4. Pressure line to consumers
5. Float switch
6. Suction line
7. Emergency overflow
8. Rainwater filter PURAIN
9. Floating intake filter
10. Calming inlet
11. Protective conduit pipe for suction line and sensor cable
12. Rainwater line
13. Wall bushing MD100

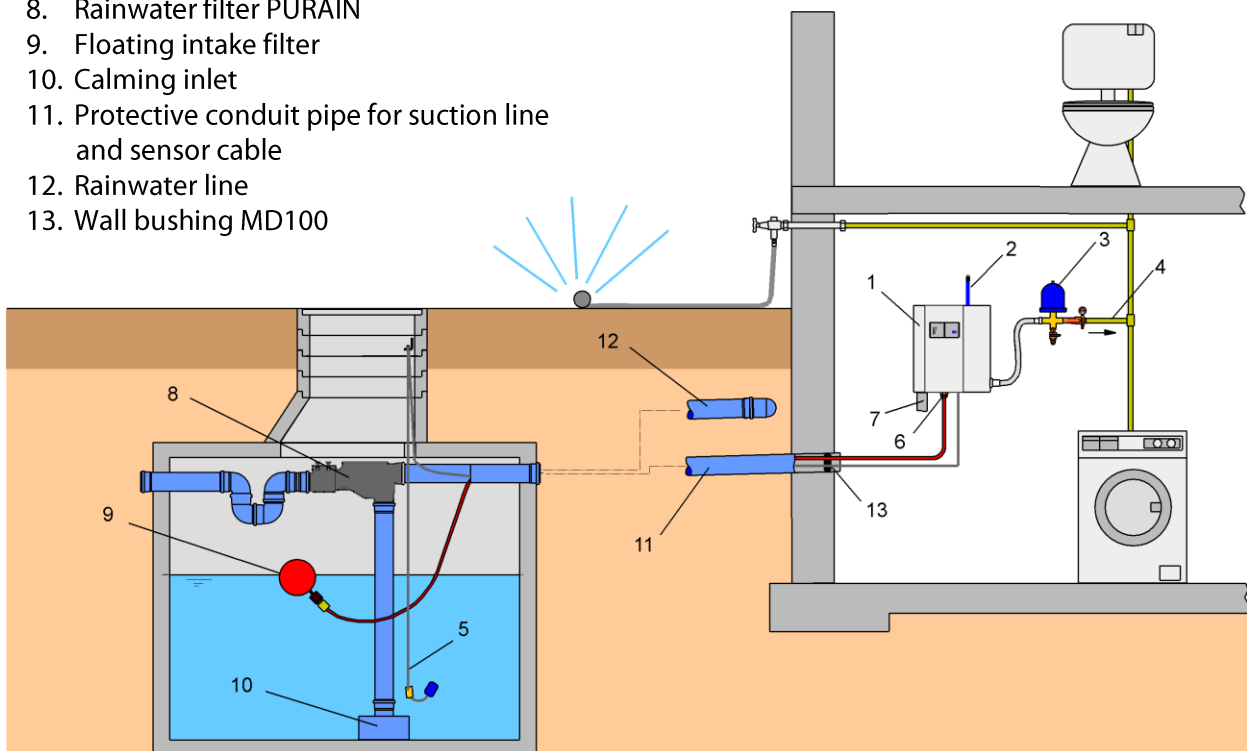

An example of a rainwater harvesting system with external storage

2. Safety instructions



The live components have to be installed only by a qualified electrician. In case of failure of the electronic device, the product has to be repaired by a qualified electrician before being operated again. There is a risk of electric shock!

The outlet circuit used for the device has to be secured through a circuit breaker protected (16 A in several countries). If unavailable, an FI switch with maximum operating current of 30 mA has to be connected.



These installation and operating guidelines have to be read carefully before installing the product. The instructions mentioned have to be followed strictly. Modifications to the product are not permitted, otherwise the warranty becomes void.

The following points have to be strictly observed during the installation and operation:

- Check the product before installation for any visible defects. If defects are present, then the product must not be installed. Damaged products can be dangerous.
- Installations at the fresh water pipeline system have to be only performed by a qualified installation firm.
- A floor drain has to be provided near the installation site, which can collect inadvertent water discharge (such as with pump defect, pipe breakage etc.) and prevent water damage inside the building. The brickwork behind the water-carrying system must be protected from water (such as with water-resistant paint).
- Make sure that the existing emergency overflows are connected and adequately sized.
- Remove the mains plug if you will be away for more than 24 hours. Lock the fresh water line at the inlet of the device if you will be away for more than 24 hours
- All products must be regularly inspected to maintain proper condition. The minimum inspection interval is mentioned in the maintenance manual.
- Electric devices may be hazardous for children. Therefore children always have to be kept away from the product. Do not let children play with the product.
- Do not install the water-carrying products in locations where the temperature may drop below 0 °C.
- Do not install any electric products in flood-prone areas.
- The operator is responsible for adherence of the safety and installation guidelines.

3. Scope of delivery

RM Eco unit



Wall mounting material and installation and operating manual



Standard accessory A
(mains water connection)



Standard accessory B
(pressure line set)



Standard accessory C
(float switch)



4. Technical data

	RM Eco 10
Dimensions (H x W x D) / Weight:	398 x 353 x 200 mm / 8 kg
Switching power supply input:	110-230 V AC / 50-60 Hz
Switching power supply output:	24 V DC +/- 5%
Basic controller input:	22-28 V DC
Power consumption:	90 W
Max. operating pressure:	3.5 bar / 50 psi
Max. flow rate:	10 l/min / 2.64gpm
Intake height (self-priming):	see intake diagram
Pump start-up pressure:	approx. 2.4 bar / 34 psi
Noise level:	approx. 50-56 dbA
Permitted mains water pressure:	2.5 - 6 bar / 36 - 87 psi
Max. height between pump and consumer:	10 m
Mains water connection (BSP):	1/2" female
Pressure line connection (BSP):	3/4" female, union nut
Intake connection (BSP):	3/4" male
Emergency overflow connection supplemental supply container:	DN50 / Ø55mm
Protection class:	IP 44
Floating switch cable length x diameter:	15 m x Ø8 mm
Protection class:	IP68

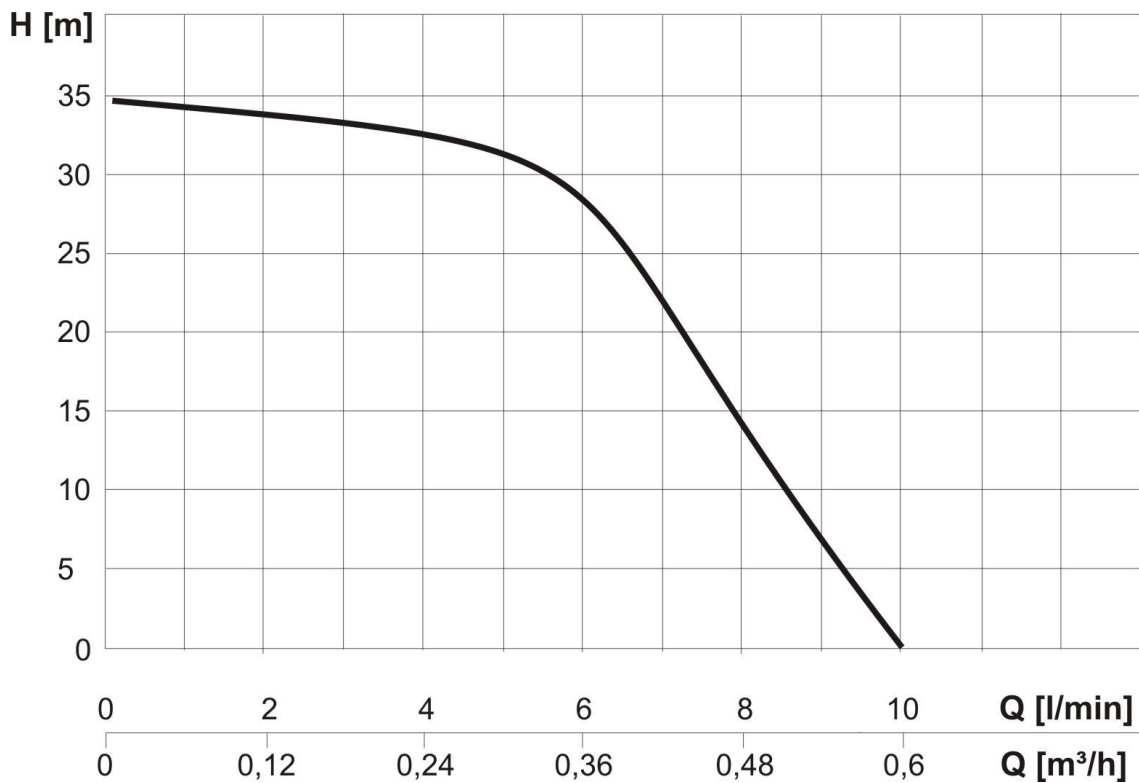

Performance curve of RM Eco 10

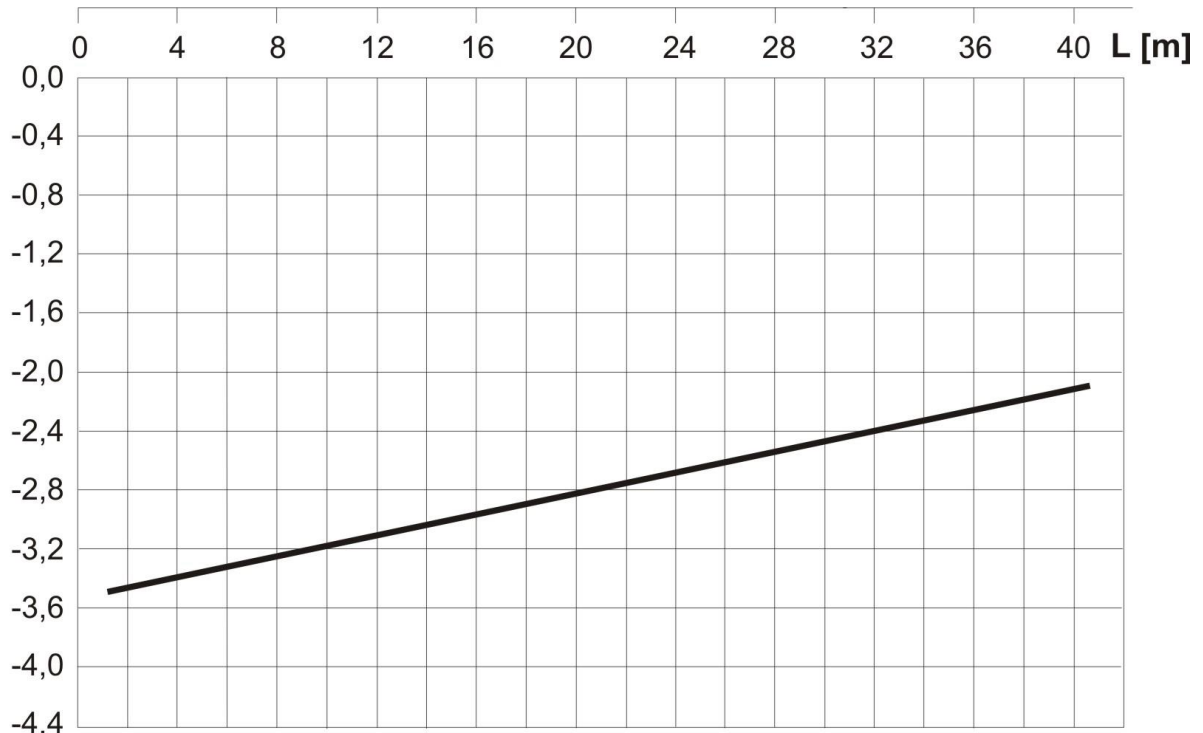

h [m]

Performance curve of the intake of RM Eco 10

4.1 Device overview and dimensions

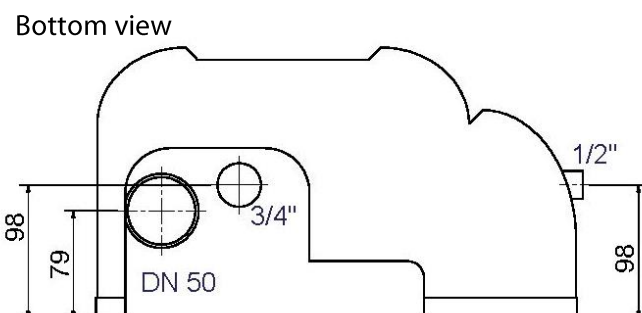
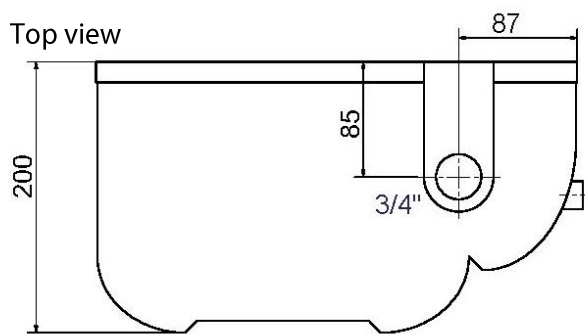
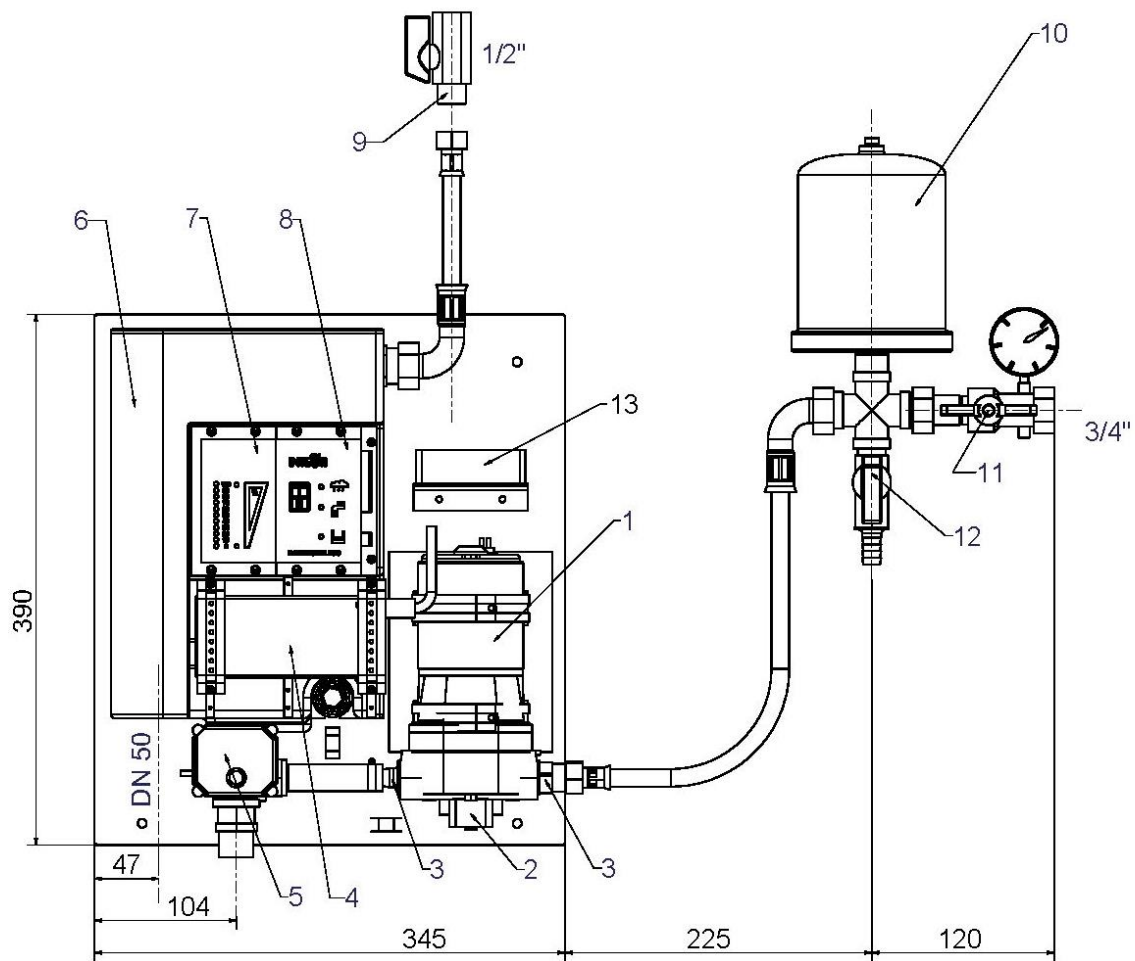

1. Diaphragm pump
2. Pressure switch
3. Line fitting
4. Switching power supply
5. 3/2-way motorised ball valve, intake connection (3/4" male)
6. Supplemental supply container with overflow DN50 (Ø55mm male)
7. Place holder for fill status indicator RM Eco-FS (optional)
8. Basic controller
9. Stopcock for mains water (1/2" female)
10. Expansion tank
11. Pressure shut-off valve (3/4" female)
12. Vent cock
13. Fan

4.2. Dimensioning of the intake line

In practice, the pump automatically starts intake due to decrease in pressure (pipe friction, intake level) only in a certain range. In this operating range, it evacuates the air from the pump independent of the suction line (for example, with initial startup operation). The intake characteristic line indicates the dependence of intake length on the intake level. The determined value is above the represented intake line in the diagram. If the intake point is below the intake performance line, then a charging pump (optional accessory RM Eco-LP) is used to ensure the intake process proceeds reliably and with sufficient safety.

Note: The charging pump boosts the water intake pressure, so that an intake level of up to 3 m high can be attained. This means that, the performance curve moves 3 m (9.8 ft) down parallel to the original.

Sample dimensions:

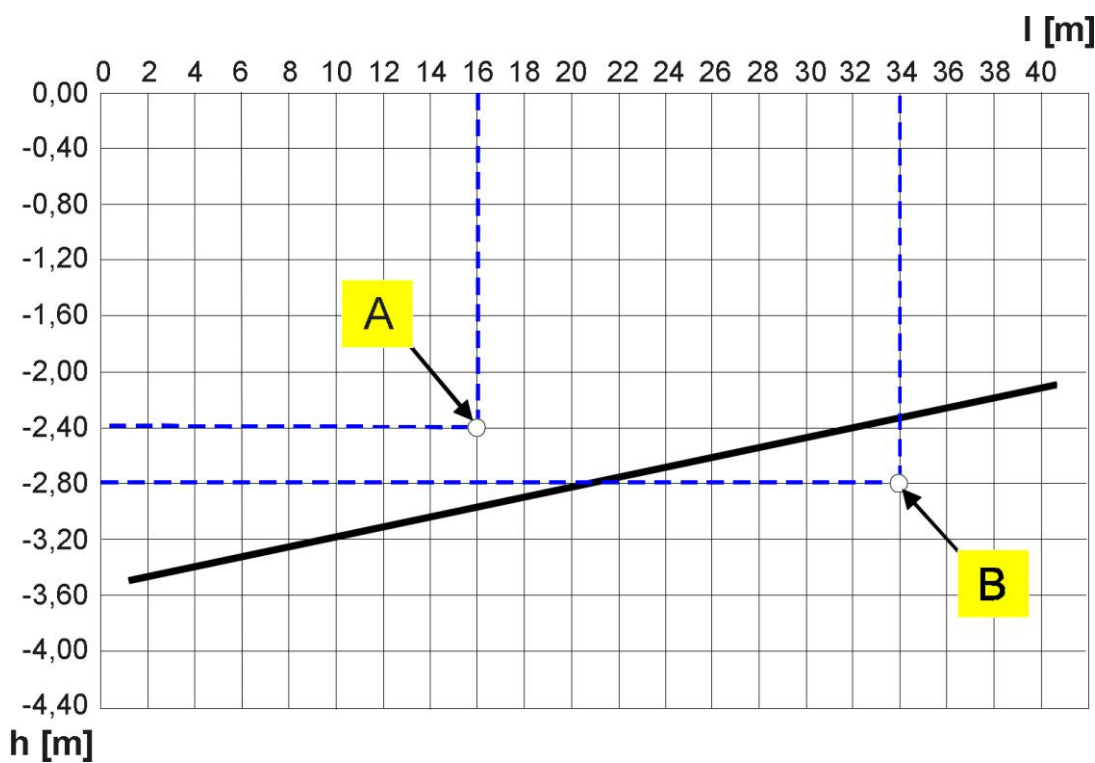

Example A:

Length of suction pipe: = 16 m

Intake level: = -2.40 m (Height between deepest suction point and pump)

→ o.k. since above the characteristic curve

Example B:

Length of suction pipe: = 34 m

Intake level: = -2.80 m (Height between deepest suction point and pump)

→ not o.k. since below the characteristic curve

→ RM-Eco-LP (Art.-No. 22 00 97) charging pump is required

4.3 Standards, directives, tests

The *RM Eco* meets the DIN 1989-4 “Components for Control and Supplemental Supply” standard for rainwater harvesting systems. The DVGW mark of approval confirms the presence of the mandatory “air gap” (as per DIN EN1717) for secure separation of processed water from the mains water line, which is integrated into the *RM Eco*.

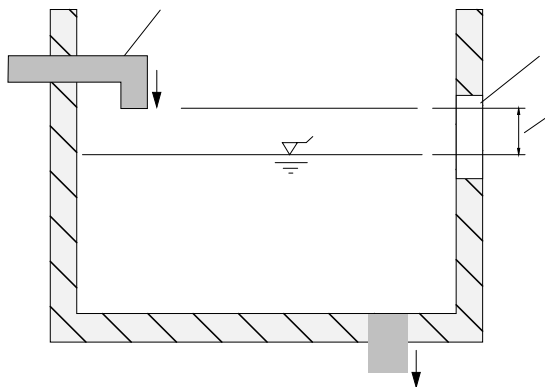

1. Mains water inlet
2. Emergency overflow
3. Max. possible water level
4. Air gap = secure separation of mains water and processed water

Mains water supplemental supply device, Type AB as per DIN EN 1717

The power is supplied via a TÜV GS-certified switchable power supply. All components of the *RM Eco* are run on 24 V DC low voltage technology.

The above mentioned device corresponds with the basic safety and health requirements of the EC directives for machines. Any modification of the device not coordinated by INTEWA will void the warranty.

This equipment specifically fulfills the requirements of the following EU directives:



- EC directives for machines (89/392/EEG) in accordance with 91/368/EEG
- EC Low voltage directives (73/23/EEG)
- EG Directives for electromagnetic compatibility (89/336/EEG) in accordance with 93/31/EEG

The conformity of the equipment with the above mentioned directives is confirmed by the CE symbol.

Applied harmonized EU standards:

EN 60335-1: 1194/A1/A11/A12/A13/A14, EN 60335-2-41: 1996

Applied standards and technical specifications:

DIN 1988-2, DIN 1989-4, DIN EN1717, DIN EN 13077, BGA KTW

Tests/Monitoring:

Mains water supplemental supply device certifications:	
Mains water supplemental valve certification:	
Switchable power supply: TÜV Rheinland, TÜV GS approved	

5. Overview of components

The RM Eco has a modular design. Each component can be separately changed.

5.1 Components of basic controller

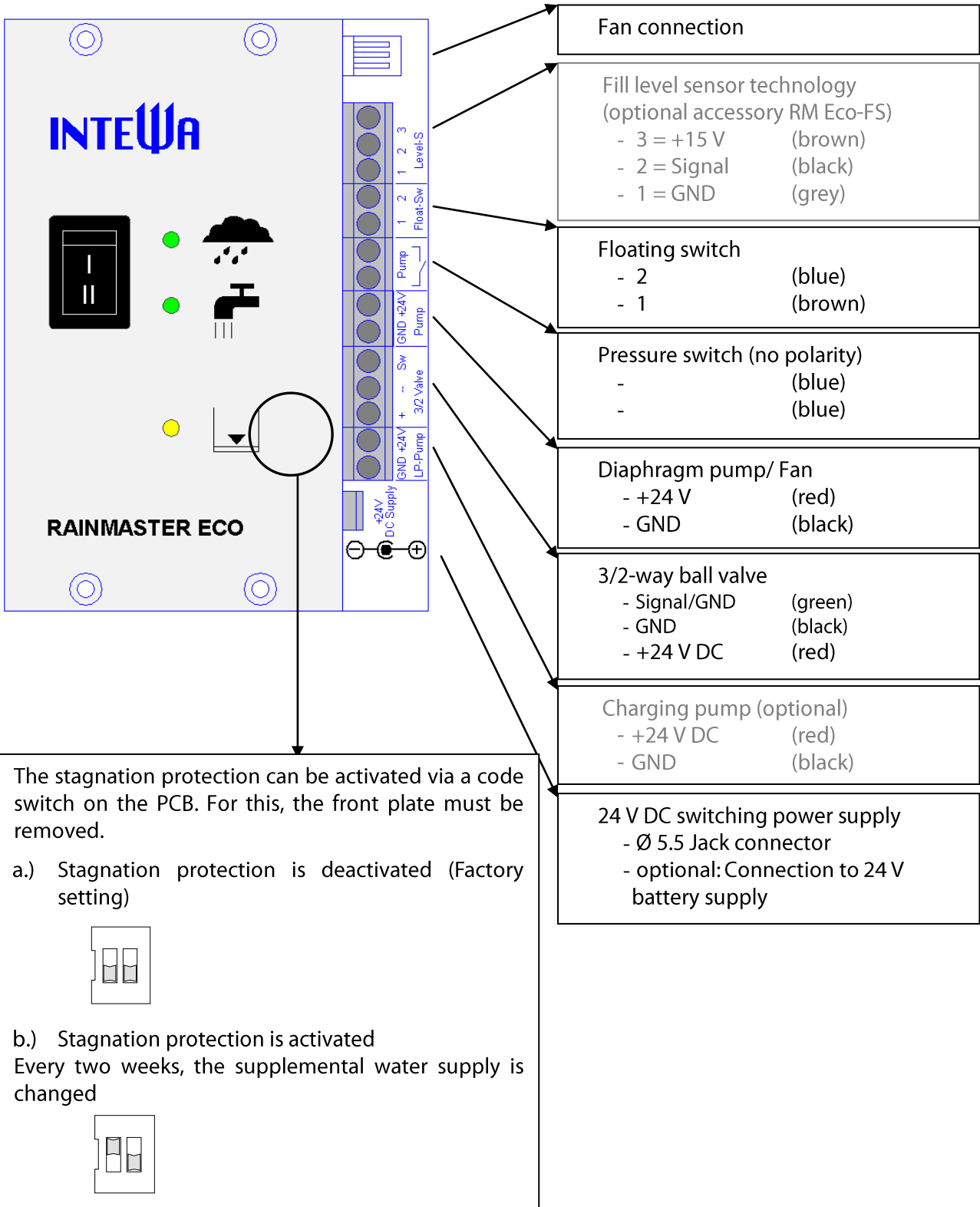

5.2 Components of diaphragm pump

5.2.1 Membranpumpe

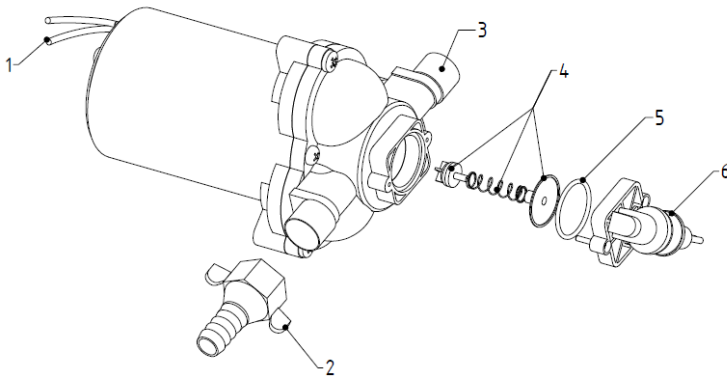

1. Supply cable (red/black)
2. Suction connection (union nut/hose)
3. Pressure connection (fix)
4. Non-return valve
5. O-ring seal
6. Pressure switch with fastener

Pump for Rainmaster Eco 10

5.2.2 Fan



The fan cools the pump by a uniform air flow. If no continuous operation is provided, the fan can be disconnected electronically. This saves about 6W power. Nevertheless, if the pump is operating continuously (without fan) with high back pressure and the pump is getting too hot, the internal pump temperature sensor will stop the pump. After cooling down the pump starts automatically again.

5.3 Components of the supplemental supply container

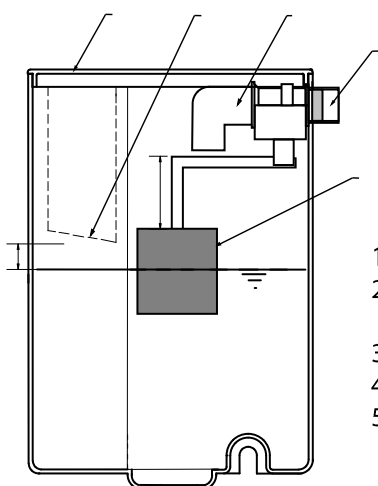

1. Lid
2. Emergency overflow rim
3. Floating valve
4. Protective sieve
5. Floating body

The floating valve keeps the water level constant in the supplemental supply container. The maximum water level should be approx. 2-3 cm below the overflow rim when the floating valves closed (backside of the container).

The correct distance of the float (5) to the horizontal lever is factory set at 6 cm.

Note: If an overflow occurs due to continuous dripping from the valve, the valve must be decalcified (see Maintenance). The floating valve incorporates a protective sieve.

5.4 Components of electronic 3/2-way ball valve

The ball valve selects between rainwater intake and mains water intake. The built-in display shows which mode is currently selected.

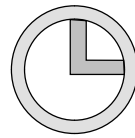

Position mains water mode
Pump takes water from the supplemental supply container

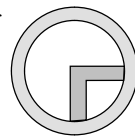

Position rainwater mode
Pump draws water from the rainwater tank

5.5 Components of the pressure line set

The pressure line set contains an expansion tank, which is necessary to ensure the silent operation of the system. A pre-pressure of 2.0 bar is preloaded at manufacture. The expansion tank ensures that the vibration created by the operation of the pump is not transmitted through the piping system.

Procedure for pre-pressure inspection / preparation:

- 1.) Disconnect the mains power to the RM Eco.
- 2.) Close the pressure shut-off valve.
- 3.) Open the vent cock for draining the system pressure to 0 bar.



- 4.) Check the air pressure in the expansion tank with an air pump (with pressure gauge). You can use a bicycle pump or car tyre pump.
Should the primary pressure be too low, use your pump to increase it to the desired pressure.



- 5.) Reconnect the mains power to start the unit again and drain the water, via the vent cock, until bubble free water comes out.



- 6.) Close the vent cock and open the pressure shut-off valve.

The system is now ready to use.

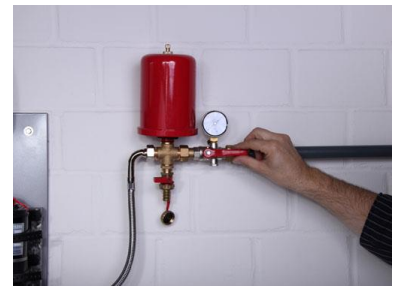

6. Installation instructions for RAINMASTER Eco

The foam and polystyrene parts 1-3 are part of the transport safety and must be removed before installing the RM-Eco.

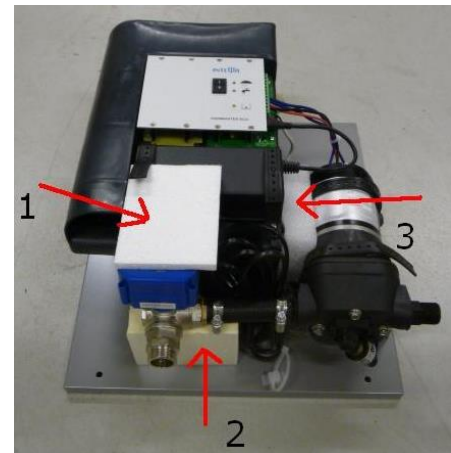

6.1 Wall mounting

The *RM Eco* is mounted on the wall using the mounting material provided. The lid, bottom and lateral distances indicated should be adhered to when mounting to provide clear maintenance access.

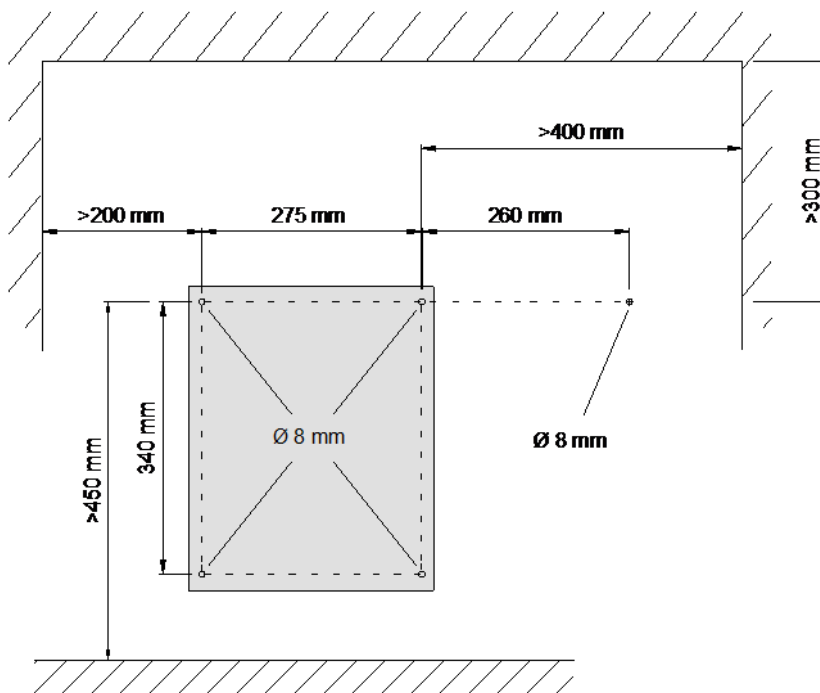

The *RM Eco* is fixed horizontally with of Ø8 mm raw plugs and screws. An additional hole is also drilled 260 mm top and right of the upper mounting holes for connection of the expansion tank mounting bracket.



In order to avoid vibrations, the *RM Eco* must be fixed with all four screws.



6.2 Connection to the mains water line

The connection to the mains water line is done with the provided flexible hose with stopcock.

Note:

The flexible hose must not be mounted with tension, since the internal float valve is pressed against the inner wall from here.

All provided flexible hoses have gland screws with flat seals. The rubber seals must be present. Additional sealing material must not be used at gland nuts!

Screw the gland screw into the container connection and carefully tighten with a 30 mm fixed wrench.



Screw the gland screw on the other end of the flexible pipe into the stopcock mounted in the main water line.



6.3 Installation on the intake side

The installation of the intake requires special attention, since only correct mounting and sealing ensures trouble-free operation of the system. For fault-free functioning, ensure the guidelines concerning intake height and intake length are followed carefully (see section 4.2.).

1. Intake connection to *RM Eco*
2. Intake line
3. Wall bush
4. Protective conduit pipe
5. Floating intake

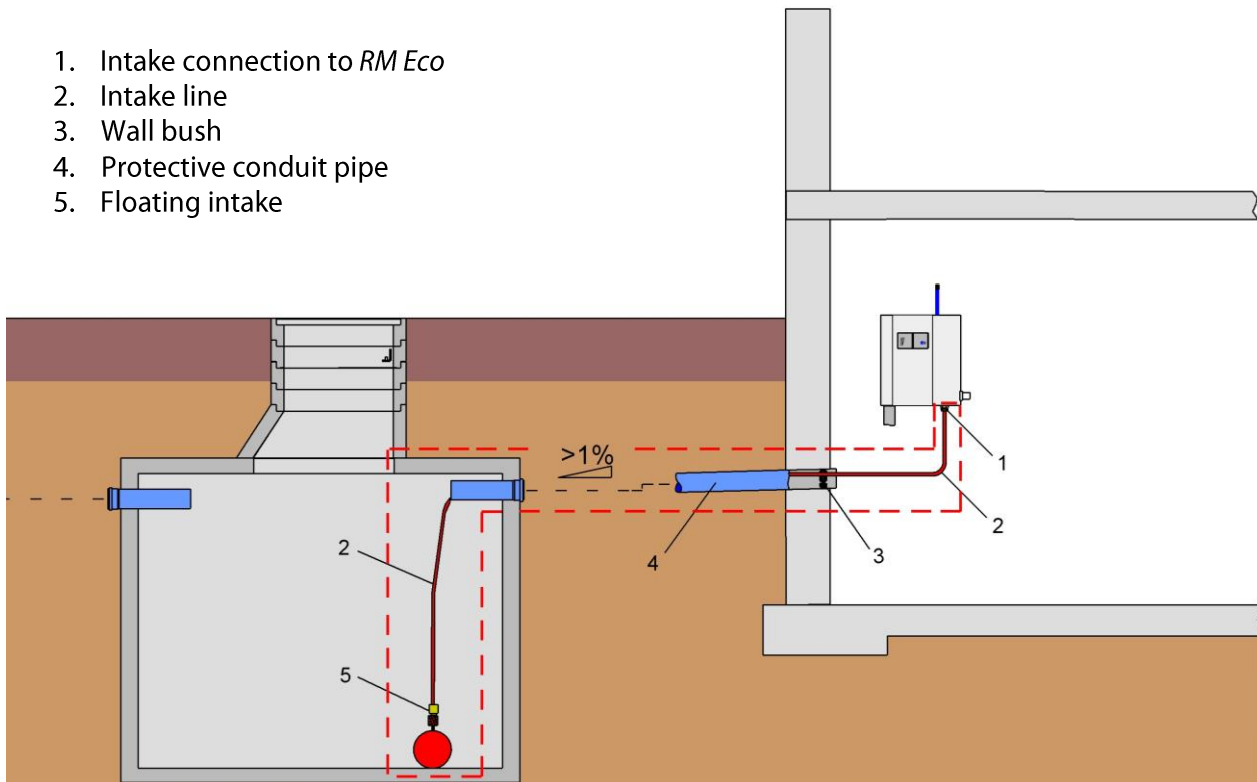

6.3.1 Installation of a protective conduit pipe

The intake line must be installed in a (e.g. DN100) protective conduit pipe in order to ensure all intake lines and pipes can be accessed freely at any time. In order to avoid water accumulating in the conduit, it must be installed with $> 1\%$ slope back towards the tank.

In general, all lines carried in the protective pipe should pass through a wall bushing (i.e. INTEWA MD-100 Article No. 61 00 50) at the house. Through this bushing, the intake pipe and the float switch cable are routed and sealed by a pressed rubber plate. This prevents water from outside entering the basement/garage/utility room. The wall bush must be mounted as per instructions so that the intake line is never squeezed (reduction of cross section!).

6.3.2 Layout of the intake line

Only an internally reinforced flexible (resistant against vacuum) hose can be used as the intake line. This means we can use a floating intake in the tank. The internal diameter of the intake line must be at least $\varnothing 13$ mm. The INTEWA intake hose (HORIZON 1/2", Article No.61 00 16) is designed for this requirement.

In order to avoid potential leaks at connection points, it is strongly recommended that the intake hose (from the intake filter in the tank all the way to the *RM Eco* unit) should be one piece – containing no joints.

Warning:

The internal diameter of the intake hose must be at least $D=13$ mm in order to obtain full volume flow.



No water filter may be used in the intake line, since the gaskets are not designed for suction pressure. The underpressure for intakes cannot be built up later and the air enters the intake line.



PVC corrugated hoses are not suitable as rainwater suction lines. Experience has shown that after some time these become brittle and permeable to gas/air. The suction pressure for intakes cannot be built up later and the air enters the intake line.



No flexible hoses can be used in the intake region since these soft, internal rubber coated hoses are constricted with suction pressure.



The intake hose line must never bend, kink or be constricted in any way.



6.3.3 Intake line connection

The intake line is routed through the wall into the house, and connected to the *RM Eco* without tension.

The gland screw is to be tightened to the *RM Eco* connector only by hand.

As the intake hose should not exert any force on the coupling to the unit, the pipe should be securely fastened to the wall with separate pipe clamps.



6.3.4 Installation of the floating intake

For best water quality, we recommend the intake line in the tank is installed as a floating intake.

The accessory product SAUGSAGF ½" (Article No. 21 01 33) meets this requirement. The rainwater is drawn from just below the water surface where the water is the cleanest. The integrated non-return valve ensures that water is always present in the suction line. The intake sieve provides additional protection against debris clogging the pump.

If the intake accessory is installed on site, make sure that the intake has a non-return valve, as well as an intake filter. The intake is mounted in such a way, that with the tank being empty, the intake sits at a minimum distance of 20 cm from the bottom of the tank. In this way, the intake of base sediment is safely prevented.

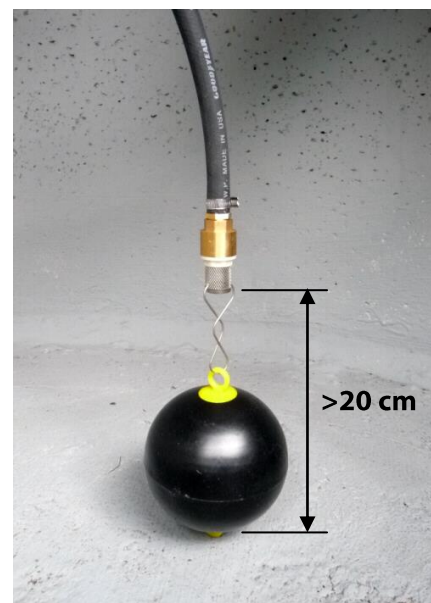

6.4 Installation of the pressure line set

The pressure line set (see section 3) establishes the connection between the pump and pressure line system.

The expansion tank is fixed to the wall with the pipe clamps provided. The vent cock is equipped with a gasket ring so that it can be screwed directly into the T piece without additional gasket.



The pressure shut-off valve, incorporating the pressure gauge, is then connected into the line by screwing the flat sealing gland screw into the expansion tank T-piece.

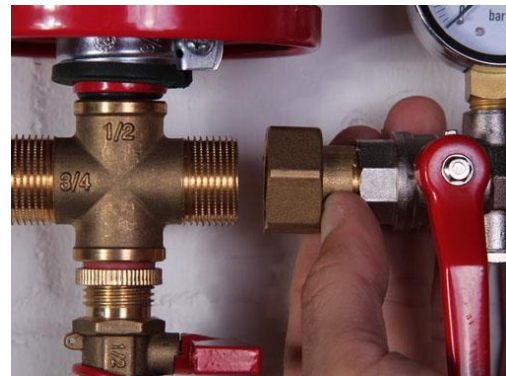

The flexible hose connects the pump pressure line to the other side of the expansion tank T-piece. These line connections are made with flat sealing gland screws.



Note: The pre-pressure of the expansion tank has to be checked (see section 5.5).

6.5 Connecting the emergency overflow

The *RM Eco* has an emergency overflow line (DN 50) which must be connected to the waste drainage system of the building. The drainage line must be of a size to accommodate a maximum volume flow rate of 20 l/min.

The position of the backwater level must be taken into consideration while connecting to a drainage system, in order to prevent backflow of drainage water from the open sewer line (design according to the DIN EN 1717) entering the *RM Eco*.

The position of the backwater level determines the type of line:

- a) Backwater level above the emergency overflow drainage height of the supplemental supply container:

Connection of the emergency overflow must be done by a lifting system.

- b) Backwater level below the emergency overflow drainage height of the supplemental supply container:

Connection of the emergency overflow to a ventilated channel line (DN 50) is done via a siphon.

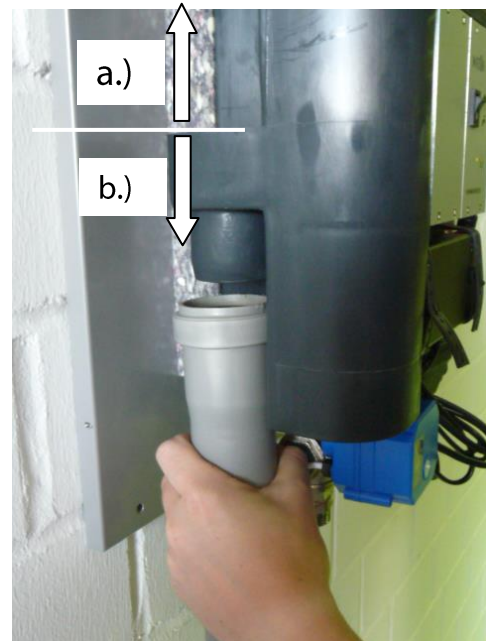

6.6 Installation and adjustment of the float switch

1. Floating switch cable
2. Wall bushing
3. Conduit pipe DN100 (grade > 1%)
4. Floating intake line
5. Counter weight
6. Floating switch
7. Cable bracket

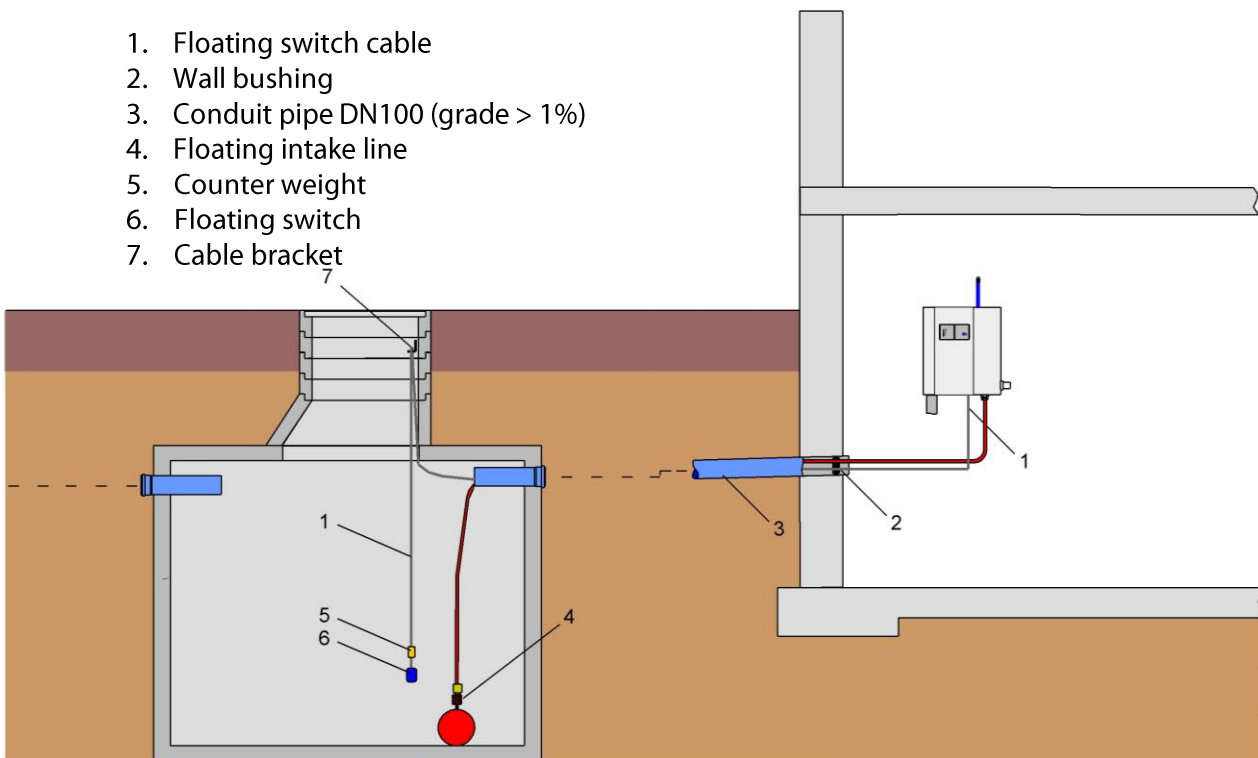

The floating switch cable is led to the *RM Eco* via a protective conduit pipe. The cable adjustment for the floating switch is installed in an accessible area of the tank opening so that it is possible to access (such as for inspection and maintenance purposes) even with a full tank level. Height can be adjusted by means of the built-in cable adjustment (cable bracket).



The intake line is installed in such a way that the floating ball just touches the bottom of the empty tank (see section 6.3.4). The floating switch counter weight (A) is mounted 15 cm above the floating switch.

The safety distance between the intake filter and the bottom of the floating switch must be at least 10 cm (B), allowing the floating switch enough cable length for free movement.

The floating switch is electrically connected to the unit controller (see section 5.1).

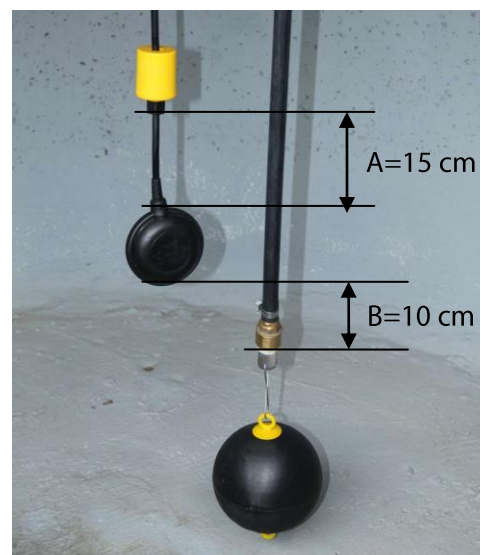

7. Start up and use

7.1 Start-up in mains water mode

1. Check that all lines are connected.

Select maintenance mode = **Switch position II.**

Open the mains water line stopcock so that the supplemental supply container is filled with water.



2. Close the pressure shut-off valve.

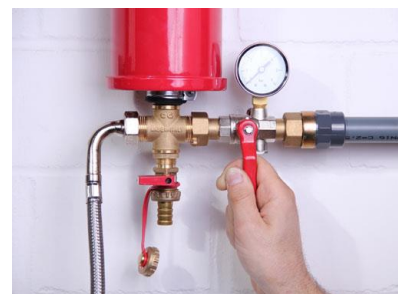

3. Open the air vent (hold a bucket of water under the air vent) and start the pump by plugging in the mains power.

Let the water run from the air vent into the water bucket until there is no more sign of bubbles (a clear stream).



4. Close the air vent.



5. Open the pressure shut-off valve and release the air from the (house) line (e.g. by flushing the toilet several times).

Close the pressure shut off valve. The pump will automatically switch off when the maximum system pressure is reached.

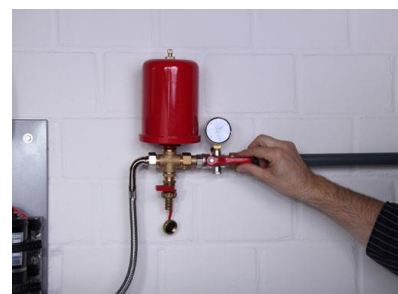

7.2 Start-up in rainwater mode

The rainwater mode can only operate if there is sufficient water in the rainwater cistern. In this case the tank display does not light up.

1.) Select automatic mode = **Switch position I**



2.) Close the pressure shut-off valve.



3.) Open the air vent (hold a bucket of water under the air vent) and start the pump by plugging in the mains power. The motorised ball valve will move into the "rainwater" intake position. Let the water run from the air vent into the water bucket until there is no more sign of bubbles (a clear stream), so that all the air is removed from the suction line.



4.) Close the air vent.



5.) Open the pressure shut-off valve and release the air from the (house) line (e.g. by pressing the toilet flush several times). Close the pressure shut off valve (house line). The pump will automatically switch off when the maximum system pressure is reached.

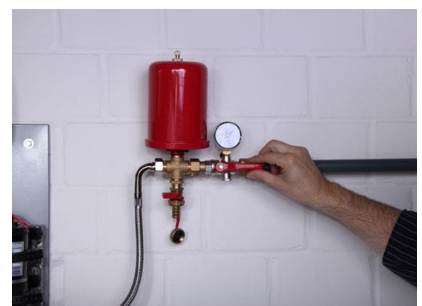

7.3 Modes of operation and display

7.3.1 Automatic mode (Switch position I)



Automatic mode
„Rainwater mode“

Automatic mode is the normal operating mode, and is selected by Switch position I. This is indicated by the upper LED. In this mode, the unit automatically switches from rain water to mains water, if the float switch detects the rainwater tank is empty.

Two operating modes can be used according to the two positions of the float switch, both of which are indicated by the lower LED:

→ Rainwater mode, if this light is OFF it indicates that the rainwater tank is full

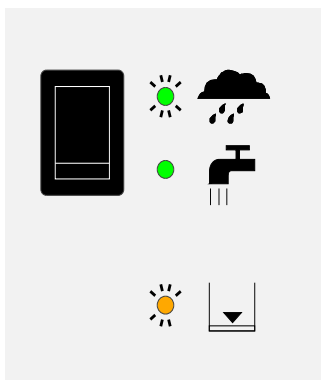
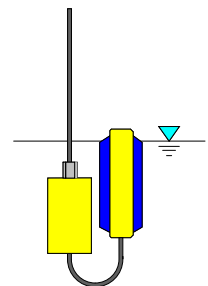

Automatic mode
„Mains water mode“

→ Mains water mode, if this light is ON it indicates that the rainwater tank is empty

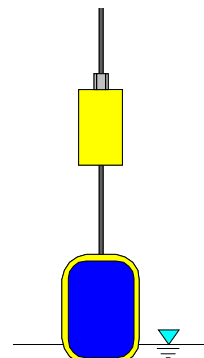

7.3.2 Maintenance mode (Switch position II)

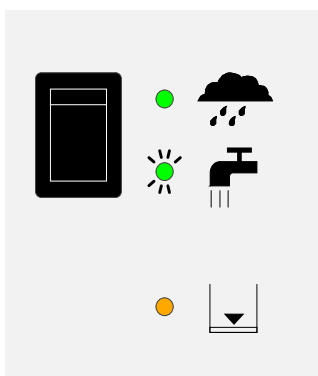

Maintenance mode
„Mains water mode“

The maintenance mode is selected by Switch position II. This mode is selected only when maintenance is to be performed in the tank. The *RM Eco* then operates in continuous mains water mode independent of the floating switch.

8. Trouble shooting in case of problems

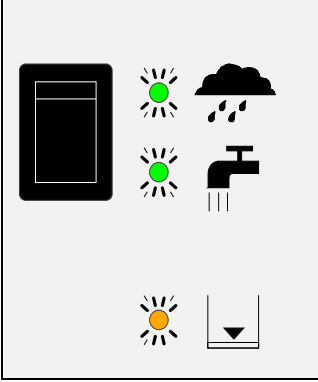
Description of error	Cause	Solution
<p>The pump is not starting and all LEDs are flashing</p> 	<p>The pump has shut down after running non-stop (2 hours continuous operation) due to:</p> <p>a) Anti-dry running protection</p> <ul style="list-style-type: none"> - Air in intake line, as float switch has not registered an empty tank and did not switch to mains water mode - Air in intake line because of a leakage <p>b) Continuous use by connected fixture</p>	<p>a)</p> <ul style="list-style-type: none"> - Check the functioning and position of the floating switch (see section 6.3.4). After this restart - Seal connection points and the intake line and restart <p>b) Avoid continuous use of more than two hours</p>





Restart from an Emergency Stop:-

- RESET by pulling out the mains plug for at least 5 seconds until all the LEDs have gone out.
- Plug in the mains plug.
(Should there no longer be water in the line and/or no pressure is built-up, then air has entered the intake line. The air must be evacuated from the air vent as described in section 7.2.)

Description of error	Cause	Solution
Pump does not start and no LED is shining	No power	Check mains supply
Pump does not start but LED display is o.k.	<p>a) Temperature protection switch, pump is overloaded due to continuous use or pulsating working modus</p> <p>b) Defective pressure sensor</p> <p>c) Carbon brushes have worn out or are defective</p>	<p>a) The pump will automatically restart if motor is cooled. Find out the reason for overload and fix it</p> <p>b) Change pressure sensor</p> <p>c) Change pump</p>
Pump does not turn off	<p>a) Power- off pressure is not obtained (< 3 bar) because of air in the system</p> <p>b) Power- off pressure has exceeded (> 6,0 bar/90psi) as pressure switch is defective</p>	<p>a) Evacuate air from the pipeline system (see section 7.2)</p> <p>b) Exchange pressure switch.</p>
Pump is ticking	<p>a) non-sealed leaky fixture</p> <p>b) withdrawal of water is too low from the fixture</p>	<p>a) Fix leakage</p> <p>b) Check fixture</p>

Description of error	Cause	Solution
Pump ticks and the green LED light flashes ON/OFF regularly	The power consumption of the pump is too high (protection switching of the power supply is activated), because a) the pressure switch is defective (pressure > 6 bar/90psi) b) Pumping motor is blocked	a) Change pressure switch (see chapter 5.2) b) Change pump
Pump does not attain the maximum pressure of 3 Bar	Air in the system	Evacuate air from the line system (see chapter 7.2)
In Rainwater mode, the flow rate is too low or pump does not feed any water	a) The intake filter is clogged b) The intake hose is bent c) The suction line or the lines are not sealed d) no switchover to mains water since float switch is incorrectly positioned or is defective	a) Clean intake filter b) Check intake line c) Check intake line and connections d) Check the functioning and position of the float switch (see section 6.3.4), then restart
In mains water mode, the flow rate is too low or the pump does not feed any water	a) Not enough or no water in the units supplemental supply tank b) 3/2-way ball valve does not switch over to mains water mode	a) Check pre-pressure of mains water, clean filter sieve in the entry of supplemental supply valve (see chapter 5.4) b) Change 3/2-Way ball valve
System does not automatically switch from rainwater to mains water and vice versa.	a) Float switch is not correctly positioned b) Float switch is defective c) 3/2-Way ball valve does not switch over in spite of the float switch signal	a) Check the functioning and position of the float switch (see section 6.3.4), then restart or change float switch b) Change float switch c) Change 3/2-way ball valve
The pump can be heard through the walls of the building	a.) Silencer is not working in the expansion tank	a) Reset the expansion tank's primary pressure to 2.0 bar (see section 5.5)
Separation chamber is blocked (water spills into the overflow)	Mains water valve is calcified	Decalcify mains water valve for 24 hrs. (see section 9)

9. Maintenance

	Description	Maintenance interval
	<p><u>Expansion vessel pre-pressure:</u></p> <p>For description of inspection and preparation of the pre-pressure, see section 5.4</p>	6 months
	<p><u>Supplemental supply valve:</u></p> <p>If the mains water valve continuously drips, then this must be decalcified. Therefore, remove the entire valve from the tank and place it in a decalcifying solution (citric acid) so that the inlet and outlet are fully submerged. Move the floating arm several times so that the decalcifying solution penetrates the valve diaphragm chamber as well (24 hours exposure time). If the dripping continues after maintenance, then the valve must be replaced.</p>	6 months
	<p><u>Cleaning the intake filter:</u></p> <ul style="list-style-type: none"> - Clean the sieve manually 	6 months
	<p><u>Cleaning the charging pump (if provided):</u></p> <ul style="list-style-type: none"> - Take off cap and clean filter foam - Twist the pump to open, remove rotor and clean. <p>Specific details in RM-Eco-LP manual</p>	6 months

10. Spare parts

Description of article	Figure no. (see page 5)	Order name
Diaphragm pump RM Eco 10, inclusive pressure switch	[1]+[2]	RM ECO P10
Pressure switch	[2]	RM ECO PD
Line fitting set (Intake side / Pressure side)	[3]	RM ECO TS
Switching power supply 24 VDC, 4 A for RM Eco 10	[4]	RM ECO N10
3/2-way ball valve	[5]	RM ECO KH
Supplemental supply container	[6]	RM ECO B
Floating valve for supplemental supply container	[3] s. p. 11	RM ECO NSP
Basic controller	[8]	RM ECO BPL
Expansion tank RM Eco 10 (1 litre)	[10]	RM ECO AG1
Floating switch 15m		RM ECO SCHW15

11. Optional accessories

RM ECO-FS, Art. No.: 220090

The RAINMASTER ECO-FS is a separate fill level indicator for installation in the *RM Eco* unit. By using this, you will always have the fill status of the tank in view.

The RM-ECO-FS contains the display module, the sensor system and the control line for the tank. The display module is simply installed in place of the blank panel on the front cover of the *RM Eco*. The connection to the *RM Eco* main board is done via a ribbon cable.

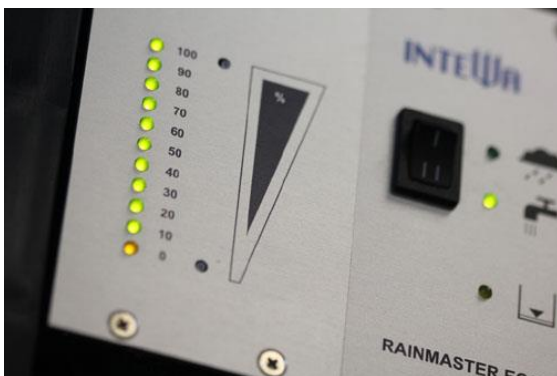

RM ECO-LP, Art. No.: 220097

The RAINMASTER Eco-LP is a separate charging pump for boosting the water intake line pressure from higher intake depths or longer intake lengths.

The RM ECO-LP contains the submersible pump the intake filter, non-return valve and the floating ball. The connection to the *RM Eco* main board is done via a ribbon cable.



12. Guarantee

INTEWA GmbH guarantees this unit for 24 months from the date of purchase. Kindly keep the sales receipt as proof of this date.

Within the guarantee period, INTEWA GmbH reserves the right to either repair or replace faulty parts at its own discretion.

The warranty does not cover any damage due to improper use, wear and tear, or intervention by third parties. The warranty does not cover any defects which may only minutely affect the value or usability of the device.

13. Contact / Device number

For customers in Germany:

For any queries, ordering of spare parts, as well as in case of service, kindly contact INTEWA GmbH directly, quoting your product's model and identification numbers and the purchase invoice details, at:

INTEWA GmbH
Auf der Hüls 182
52068 Aachen

Tel.: 0049-241-96605-0
Fax: 0049-241-96605-10
Email: info@intewa.de
Internet: www.intewa.de

For customers in other countries:

For any queries, ordering of spare parts, as well as in case of service, kindly contact your installer or the authorised importer, quoting your product's model and identification numbers, and the purchase invoice details.

Your RAINMASTER Eco's identification number is displayed on the right hand top side of the back mounting plate. The unit's main housing must be removed to see this.