

TECHNICAL SPECIFICATION	
Power supply	230v /415v
Motor rating	250W
Frequency	50 HZ
Revolutions per min.	3000
Max. vertical output	10m
Max. horizontal output	200m
Max. flow rate	500 l/min.
Max. liquid temperature	40 deg. C
Discharge size	63 O.D MDPE
Cable length	10m

ACCESS COVER (CLEAR OPENINGS)	
DIAMETER (mm)	TYPE
450	Pedestrian

FABRICATION SPECIFICATIONS				
ITEM	INDEX	DEPTH (mm)	DIAMETER (mm)	CLOCK FACE POSITION
Tank depth	A	2000		
Tank ϕ	B		610	
Inlet	C1	250	110	
Inlet	C2			
Inlet	C3			
Discharge	D	200	63	12
Cable duct			40	
Vent				

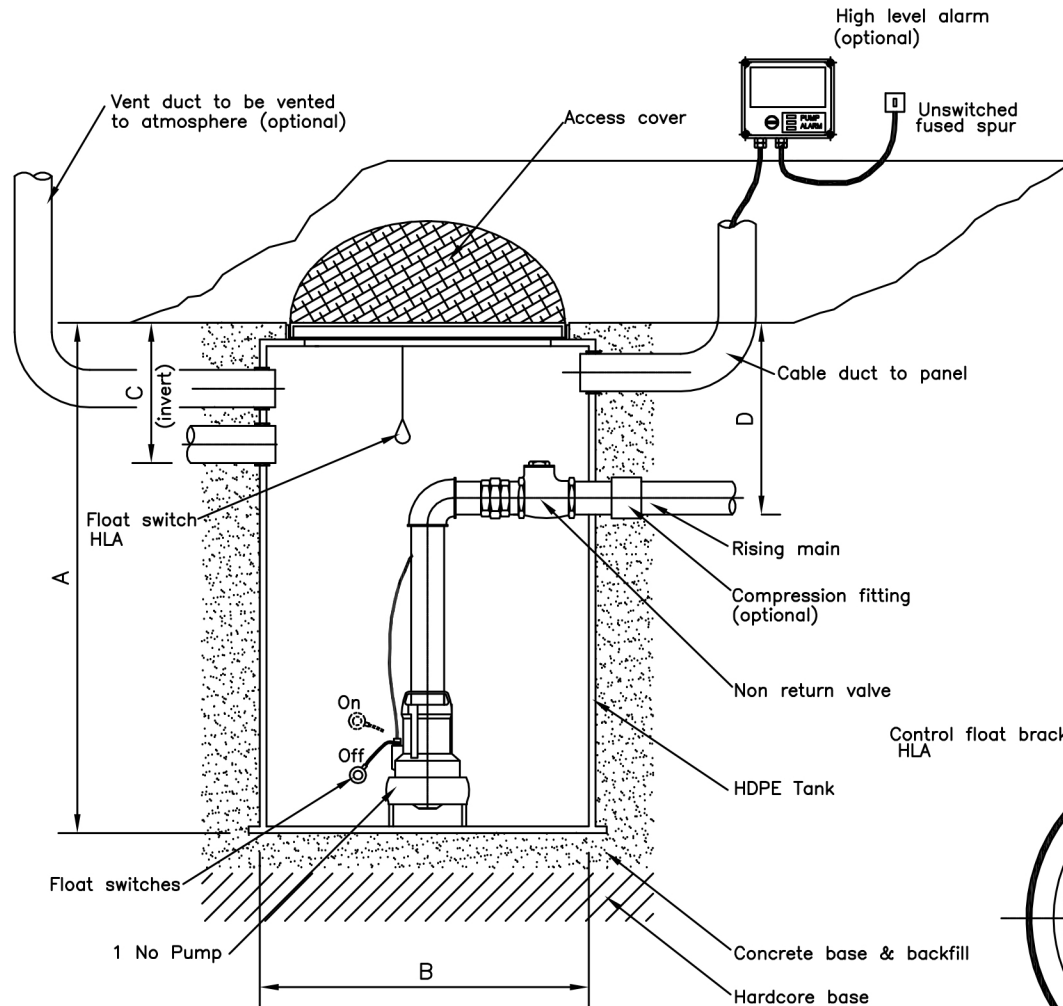
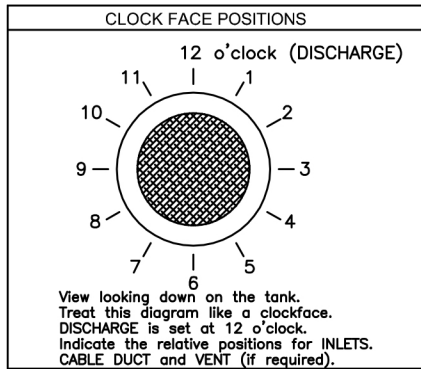

Comments

Please note that the inlet can be supplied loose and drilled on site.

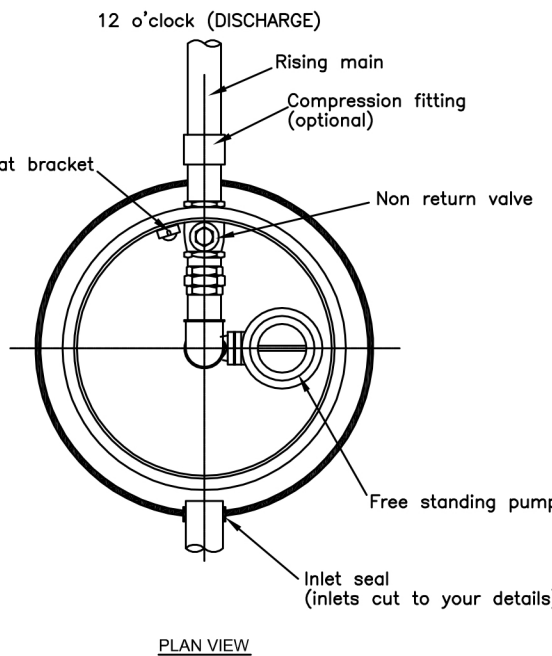

PLEASE NOTE THAT THIS DOCUMENT MUST BE READ IN CONJUNCTION WITH THE INSTALLATION & OPERATING GUIDELINES.

DRAWING NOT TO SCALE

Customer.	
Project.	Drawing No.
Project address.	Date.
Drawn by.	Checked by.