

## HOMESTREAM INSTALLATION GUIDE



## PRODUCT OVERVIEW

You have purchased a high quality product from DPT, we ask you to read the installation instructions and the operating instructions carefully to ensure a successful installation/

The product was tested using our QA and testing procedures under all operating conditions. This means that you have purchased a working product. In the unlikely event that a fault occurs, contact us on 0115 9444474 or enquiries@dpandt.co.uk

## WARRANTY

The warranty period is 24 months after purchase of this product. Within the warranty period, we provide new parts free of charge in the event of faults. This only applies to faults that are due to manufacturing and / or material defects.

## GENERAL INFORMATION

The system must be connected to the current state of the art, in particular to the technical regulations such as DIN 1988, DIN 1986, NEN 1010 and DIN EN 1717.

The user is responsible for the following:-

- The right installation,
- To respond to threats due to improper use.

The GEP Watermanager is approved for use for the following applications:-

- In rainwater systems
- 230 Volt 50 Hertz alternating current,
- For switching from rainwater to drinking water
- Up to a maximum water temperature of 35 °C,
- In the area of residential, commercial and industrial buildings as well as small businesses.

Questions about the device and the parts:

- Ask only your dealer.
- Always indicate delivery address.
- Always enter the serial number
- Always with warranty certificate (copy purchase invoice)

## PROTECTIVE MEASURES

- Mount the device in a dry, frost-free room in a room with a floor drain, eg. Scrub pits, at least 40 cm below the ceiling, measured from the top of the unit. (necessary for inspection and maintenance of supplementary unit)
- The user must strictly comply with his national accident prevention measures.
- The applicable national and EU regulations for the electrical installation have been observed in the current version. The electrical installation was approved by experts taking into account the VDE 0100 and NEN1010.
- The plug must be freely accessible
- The plug may only be plugged into the socket if the device has been installed correctly and complies with the applicable regulations. All connections have been tested for water resistance.
- It must be ensured that no persons are in the rainwater tank or during start-up with wet hands when commissioning the DPT Homestream.
- During maintenance work on the DPT Homestream, the plug must be disconnected from the mains
- All maintenance, installation or modification of the DPT Homestream and its live components can result in death or serious injury.
- Protect the power source with a RCCB (30 mA).
- The user may not carry out interventions on his own initiative that are not described in the user and installation instructions.

## INVALIDATION

Failure to follow the installation instructions and instructions for use will invalidate any warranty, the right to warranty or liability expires if the device is unscrewed, unless otherwise agreed.

# THE DPT HOMESTREAM

## PRODUCT CONTENTS

The list below outlines the contents that come with the main control unit for the Homestream controller:-

- 1 1 x Control unit
- 2 1 x Float switch bracket
- 3 3 x M6 ring
- 4 2 x Ball valve
- 5 3 x Nylon plug
- 6 3 x Bolts
- 7 1 x Float (20 meters)
- 8 1 x Mounting bracket
- 9 1 x Three-piece coupling
- 10 2 x 3/4" Flexible hose
- 11 1 x Submersible Pump (If purchased)



## HOMESTREAM CONNECTIONS



- 1. Rainwater Inlet (Suction Pipe)
- 2. Warranty Sticker
- 3. Pressure Pipe
- 4. Drinking Water In
- 5. Voltage 230v 50Hz
- 6. Float Sensor
- 7. Overflow



- 1. Rainwater Inlet (Suction Pipe)
- 2. Pressure Pipe
- 3. Drinking Water In
- 4. Voltage 230v 50Hz
- 5. Float Sensor
- 6. Overflow

## INSTALLATION GUIDE

Mount the bracket level on a flat wall with plenty of working space. (this prevents constructive tension in the device, malfunctions and resonances).



Install the unit in a room which is dry and frost free, with a drainage point in the ground and with at least 40 cm of space above the device. (required for inspections and maintenance.)



Fill the suction pipe 100% with water. Wait approx 1 min and check if the water column remains the same, if it drops it means that there is a leak. if it remains, then connect the suction pipe by twisting it onto the 3-part connection by hand.

Dirt can enter the pipe when constructing the suction pipe. Make sure to first flush the entire pipe before connecting the device.



Suction pipe

Connect the pressure pipe on the supplied tap. Then, connect the tap on the 3-piece flexible hose connector. Use the fiber ring from the connection set. Mount the pressure pipe with a bracket with rubber casing on the wall. This prevents resonances in the water network.



Pressure pipe

## INSTALLATION GUIDE

The device has to be connected to the sewer, tank or pump installation with the use of a plug socket. Note that this pipe is minimally 75 mm and can not be reduced in diameter. Use the minimum pump capacity when using a pump installation towards the sewerage system. This has to be a minimum of 3.000 L/h.

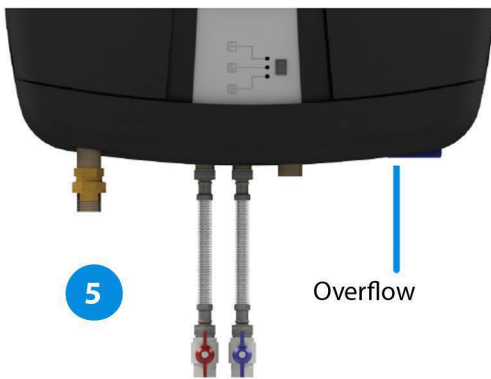

Connect the drinking water network to the supplied tap. Then, connect the tap on the 3-piece flexible hose connector. The drinking water pipe can contain dirt and small copper debris after constructing the water network. Therefore, make sure the drinking water pipe is properly flushed in order to minimize the chance of damaging the valve. Then, mount the floater switch in the rainwater tank.

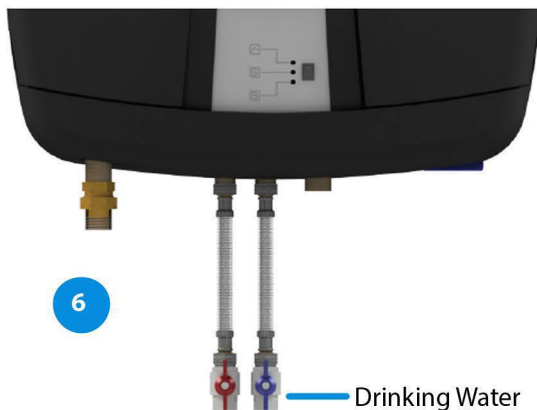

The cable of the floater to the control can be extended. Make sure this cable is water proof, the cable cant be placed underground without protection tube. We advice to apply a casing tube DN 110 which can hold the suction pipe and optionally the filter cleaning pipe.

The floater in the tank has to be able to move freely and has to be clear from the bottom and above the suction head of the floating extraction.

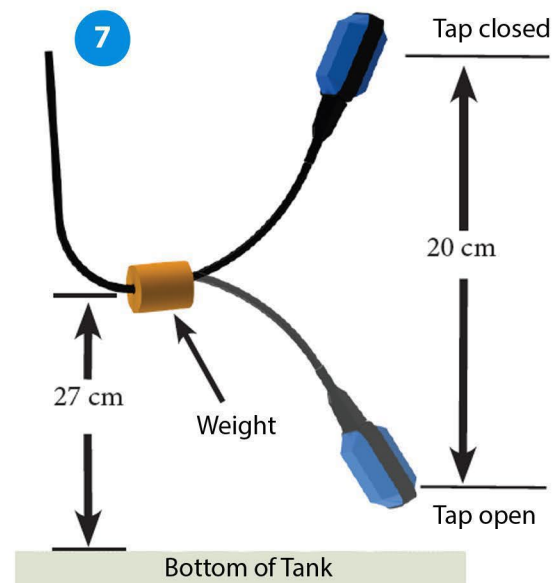

Connect the cable from the float switch to the unit. To do this, use the Wago connection terminal at the bottom of the unit. It does not matter which color is connected to which port. Press the uninsulated wires deep into the clamp and close it. The yellow/green cable (earth) does not need to be connected.



## OVERVIEW - SUBMERSIBLE PUMP

A supply pump is used when the distance between the Homestream control in the building and the position of the rain water well (s) is greater than 3 meters. The length of the Suction pipe will then be so great that the self-priming pumps will no longer be able to suck rainwater from the rainwater tank. A feed pump offers the solution and ensures that the Homestream pumps are supplied with rainwater by the feed pump that is placed in the rainwater well.

The supply pump is connected to the Homestream system control. At the moment that the Homestream system registers that rainwater is being requested, the system starts the supply pump.

The supply pump ensures that the Homestream pumps can supply sufficient water at the draw-off points.

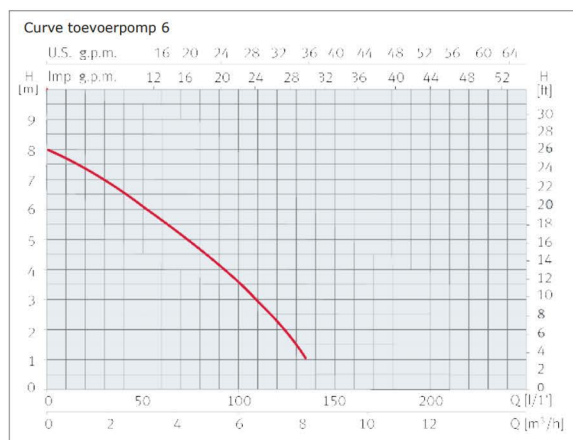
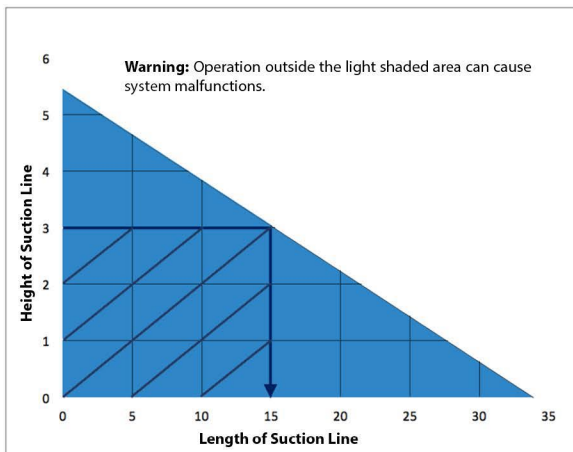

**THE PUMPED VERSION IS ONLY NEEDED IF THE CHAMBER SITS MORE THAN 3 METERS FROM THE CONTROL UNIT.**

## INSTALLATION GUIDE - SUBMERSIBLE PUMP

Mount the supply pump socket on the wall:-



Insert the telephone wire in the J45 clamp of the supply pump box:-



Insert the power plug of the supply pump box in an external 230V power outlet:-



## INSTALLATION GUIDE CONTINUED

Insert the power plug of the supply pump in the socket on the supply pump box: -

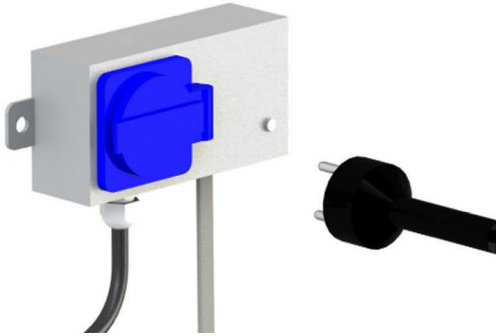

## INSTALLATION OF PUMP IN CHAMBER

- The pump must be placed firmly on the bottom.
- The pump must be secured with a steel wire so that it cannot fall over.
- At the top of the pump is a bracket for attaching the steel wire to the pump.
- The other side of the steel wire must be attached to the top of the tank.
- Preferably at or in the shaft. This way the pump can easily be lifted out of the tank for inspection.
- The pump must be filled with water under all circumstances.
- The pipes must not be kinked and do not rub against other parts
- The cable must be laid from the tank to the relevant building. For this, preferably use a jacket pipe.



Pay attention! During assembly and processing of the pipes, dirt and grinding dust can get into the pipe. To remedy this, the pipe for the final connection to the pump must be flushed with water.

- Use a minimum of 5/4 couplings and a 40 mm pipe for connecting the pump.
- The pump must be on the bottom, not hanging on the connecting pipes
- In order to prevent damage to the electrical cable, this cable should
- Preferably be connected to the pressure line with cable connectors.

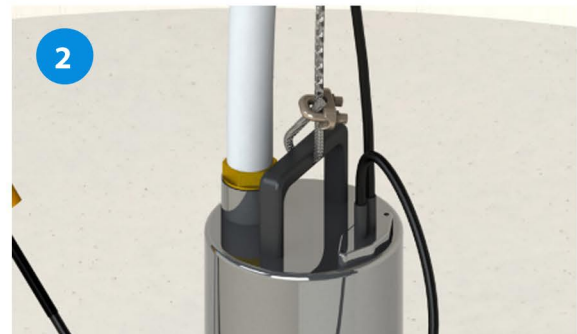

- Place the non-return valve on the delivery side of the submersible pump with the arrow pointing upwards.
- Place the discharge hose on top. • Ensure a pressure-resistant watertight connection



## INSTALLATION OF PUMP IN CHAMBER CONTINUED

Floating suction connection, this suction must be connected to the suction connection point that is directed to the center of the tank.

The hose must be mounted on the pump in such a way that the rotation of the hose causes the hose to point itself upwards. Ensure that the hose can move freely and does not rub or bump into anything

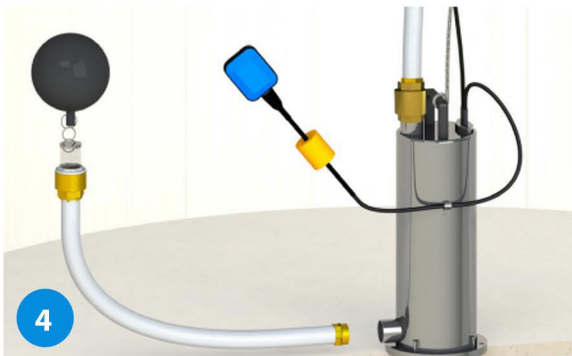

Fill the pressure line manually with clean water, then mount the delivery hose on the 40 mm tube (placed by the contractor). through the brass coupling 40x5 / 4 inch.

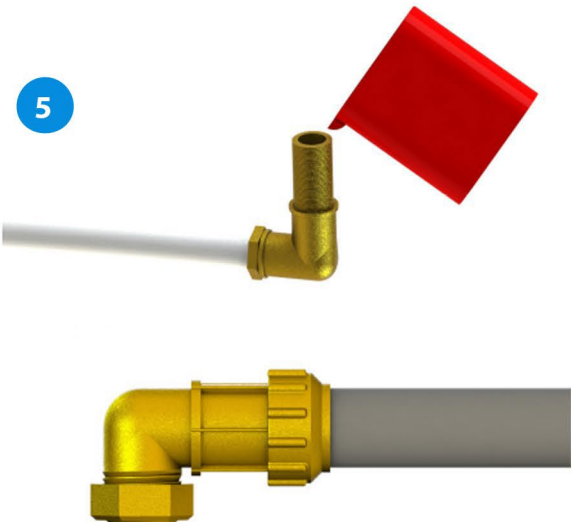

Mount the hoisting chain or hoist rope at the top of the manhole, then route the electrical supply cable through the casing to the technical room



Fill the rainwater well (partially) with water, so that the pump is under water. Ensure that the floating suction does not rub against the wall and can move freely, so that it cannot become entangled with float switches or level sensors.

Test the pump for flow. If a full stream of water without oxygen flows, the supply pump is ready for use





# THE DPT HOMESTREAM

## COMMISSIONING OF THE HOMESTREAM

Vent out and refill the device. Twist off the refill cap and fill the pump entirely with clean water. Then, twist the cap back on by hand and open the drinking water supply.

Then, open a disconnection point in the pressure pipe and then insert the plug (230V outlet). The pump now starts. Close the disconnection point.

The pump now brings it maximum pressure and turns off.

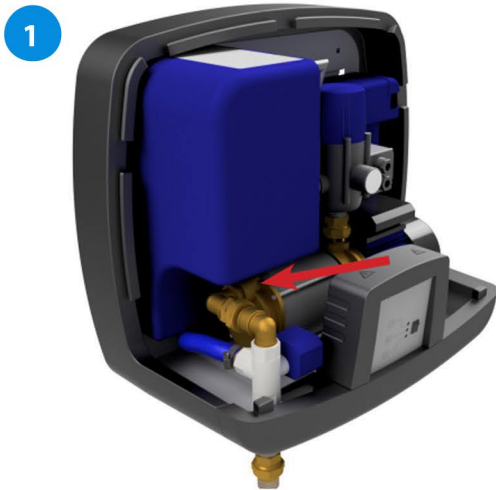

Now switch to automatic operation. The lower green LED lights up on the control panel. The 2nd green or yellow LED lights up depending on the level in the rainwater tank.



Switch: AUTO

Rainwater use, This is the operating state in which the appliance must stand. The pump automatically picks up rain water

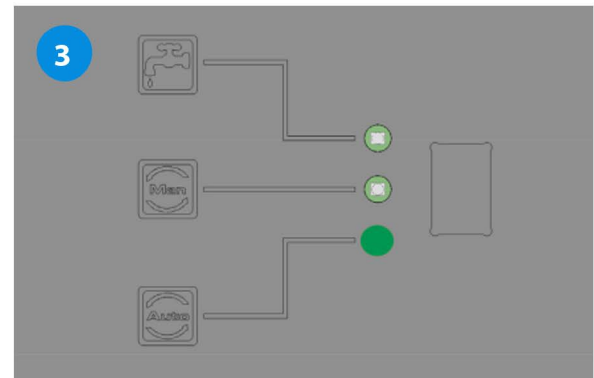

Switch: AUTO / DRINKWATER

- Drinkwater use (rainwater tank is empty)  
- In operation

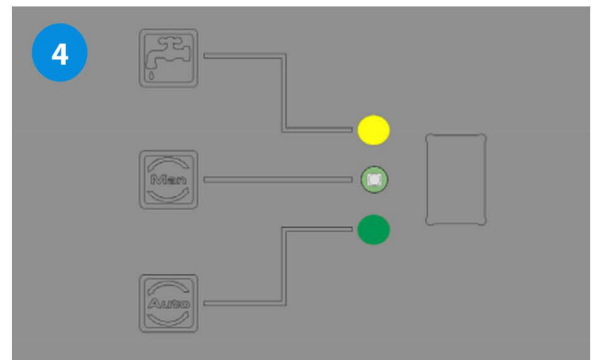

Yellow LEDs are lit continuously, so do NOT blink!

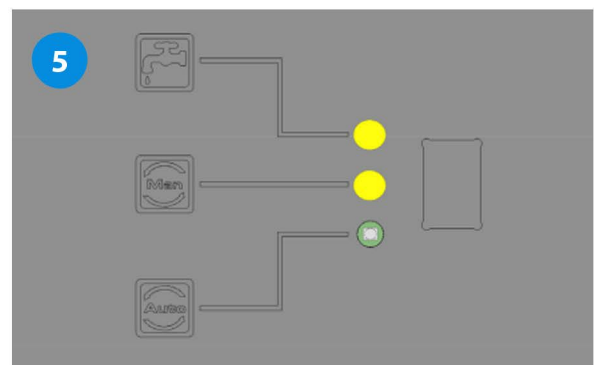

## COMMISSIONING CONTINUED

### Alarm

- Overflow alarm: yellow LED flashes, check the operation of the drinking water replenishment float.  
RESET: convert switch. - In operation.

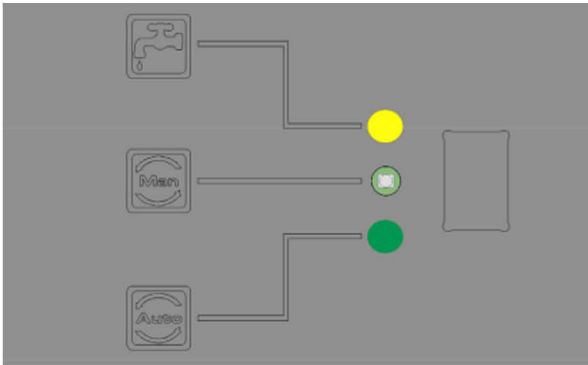

## MAINTENANCE

The device contains parts where inspection or maintenance is required. The time intervals with which this is done must, in the interest of the user, be respected.

- Inspections can be carried out by the user!
- Maintenance must be carried out by an installer

Inspection and maintenance of the device:

### Housing Inspection

Check the housing for contamination and correct confirmation.

Cleaning: Remove dirt on the outside of the device with a damp cloth and a household cleaner.

Make sure that there is no moisture in the plug, switch or behind the control panel.

Time interval: Annually

Execution: User

### Supplementation unit

Inspection: Checking correct opening and closing and the free movement of the float arm.

Time interval: Every 6 months, depending on "hardness" (PH value) of local drinking water.

Execution: User

Maintenance: Adjust the float arm.

Time interval: Only necessary for alarm message "emergency overflow"

Execution: Skilled user or installer

### Control panel

Inspection: Check the functions of the control panel, see chapter on control panel.

Time interval: Every 6 months

Execution: User

### Pump including pressure control

Inspection: Pressure build-up, Density, Pump and flow noise and function. Short for this press the "RESET" pressure switch on the pressure controller until the pump starts.

Time interval: Every 6 months

Execution: User

Maintenance: Replace gaskets / bearings

Time interval: Every 10,000 operating hours, 10 years or with premature wear

Execution: Installer / Manufacturer

### Drinking water seal

(Rubber gasket between drinking water tank and float).

Inspection: Check correct assembly and sealing.

Time interval: Every 6 months

Execution: User

### Float switch / Pressure sensor in rainwater tank

Inspection: Test correct installation and function of float switch / pressure sensor. Check cable for kinks, cracks and other signs of age

# THE DPT HOMESTREAM

## HOMESTREAM FLOATING SUCTION OVERVIEW

The below is a visual representation of the DPT Homestream below-ground chamber and associated components. Please take time to review the system prior to installation.

1. Rainwater inlet
2. PF filter
3. Access Cover
4. Overflow
5. Suction Intake
6. Calmed Inlet

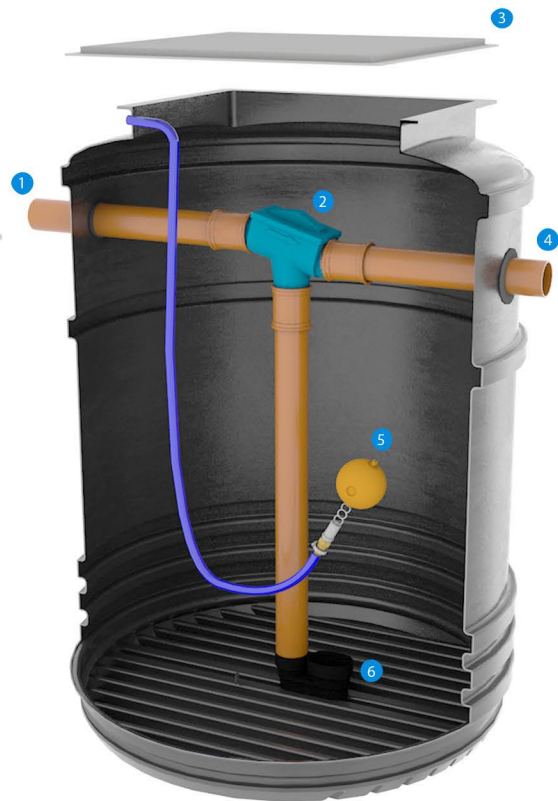

## HOMESTREAM PUMPED SUCTION OVERVIEW

The below is a visual representation of the DPT Homestream below-ground chamber and associated components. Please take time to review the system prior to installation.

1. Rainwater inlet
2. PF filter
3. Access Cover
4. Overflow
5. Suction Intake
6. Calmed Inlet
7. Pumped Suction Inlet

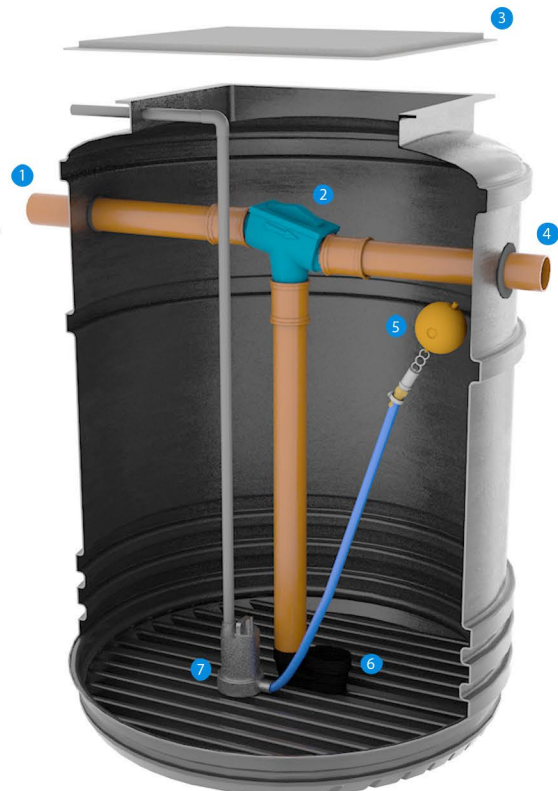

## CHAMBER DIG DEPTHS

Chamber Diameter	Chamber Depth	Minimum Excavation Depth	Minimum Excavation Diameter
1000mm	1500mm	1900mm	1300mm
1200mm	1500mm	1900mm	1500mm
1200mm	2000mm	2400mm	1500mm
1500mm	1500mm	1900mm	1800mm
1500mm	2000mm	2400mm	1800mm

## BELOW-GROUND PACKAGE CONTENTS

This section highlights the various components that come with the Homestream as standard and optional extras if ordered.

- 1 x MDPE Chamber
- 1 x Submersible Pump (if ordered)
- 1 x 1 1/4" Internal Pipework
- 1 x PF Filter System
- 1 x Calmed Inlet
- 1 x Float Intake
- 1 x 3 Meter 32mm MDPE Pipe
- 1 x 32mm Connector (fitted to tank)
- 1 x 32mm Connector (fitted to control unit)
- 1 x Access Cover

## APPLICATION

The Homestream is designed to collect rainwater from a domestic property to provide reusable rainwater in toilets, washing machines, and outside taps.

## MAINTENANCE

The Homestream is manufactured using high quality components designed to give a long trouble-free life. With any type of mechanical equipment regular preventative maintenance is required to keep the product working efficiently on a day-to-day basis.

We recommend this system is serviced yearly by specialist pump engineers. Contact us on 0115 9444474 or contact our support team on: [office@dptservices.co.uk](mailto:office@dptservices.co.uk)

## DISCHARGE PIPEWORK

The Homestream has been designed to accept 32mm discharge pipework. Use the table below to familiarise yourself with the pipework size required for the system.

- Pipework Size:** 32mm
- Pipework Type:** Solvent weld
- Termination:** 1 1/4"

## INLET

The Homestream is provided with 2 x 110mm/150mm inlet seals, these are pre-fitted.

## CABLE DUCT PIPEWORK

The Homestream has been designed to accept 40mm and 110mm standard drainage pipes.

## ELECTRICAL CONNECTIONS

Please refer to the table below for the correct isolator needed for submersible pump (if purchased) :-

- Pump Code:** HS/SP
- Pump Arrangement:** Single
- Breaker Type:** 10 Amp Fused Spur

# THE DPT HOMESTREAM

## CONNECTIONS OVERVIEW

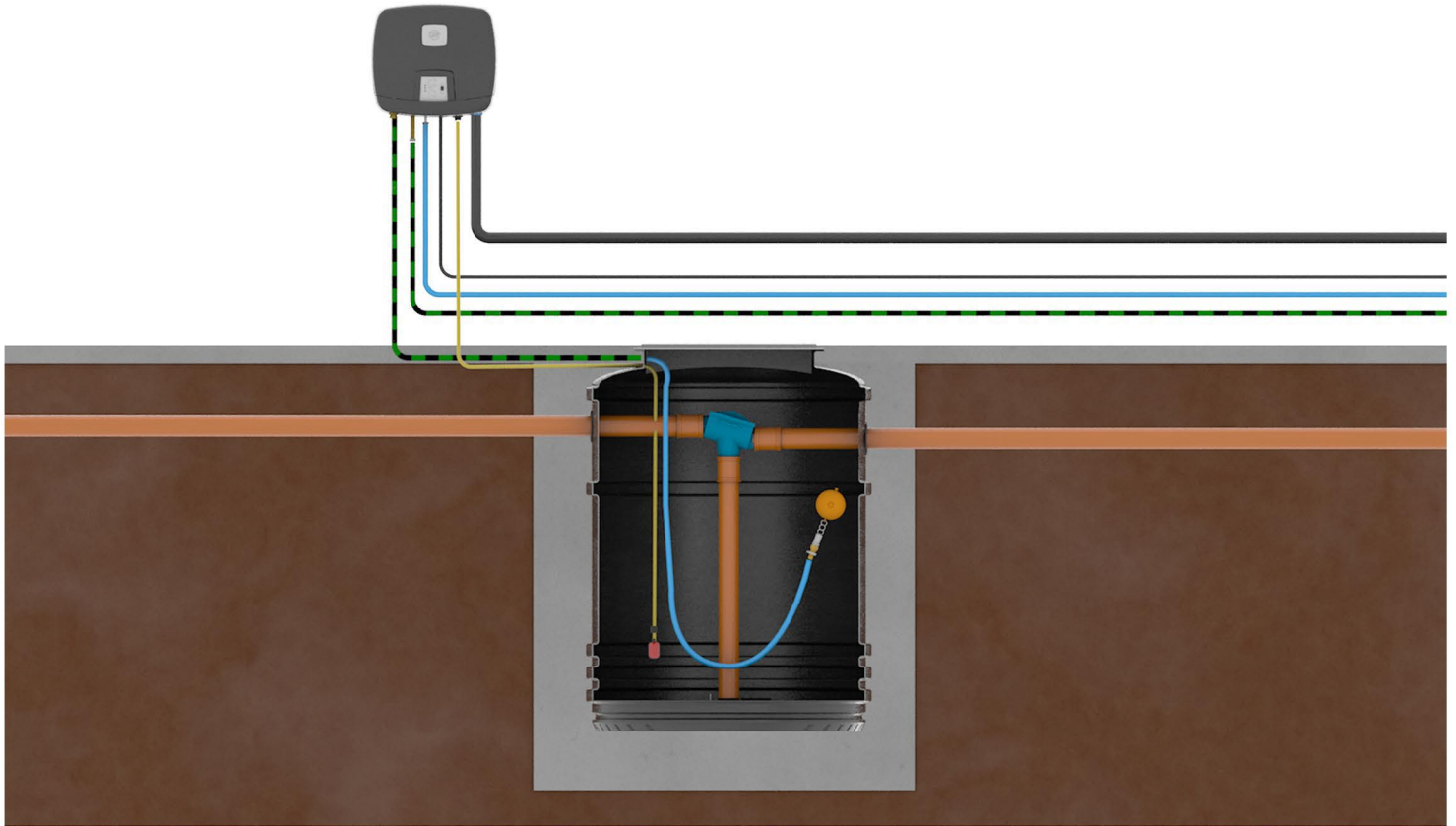

1. Rainwater inlet (Suction pipe)
2. Suction pipe to outlets
3. Drinking water in
4. Voltage 230v 50Hz
5. Float sensor
6. Overflow pipe

# THE DPT HOMESTREAM

## CONNECTIONS OVERVIEW

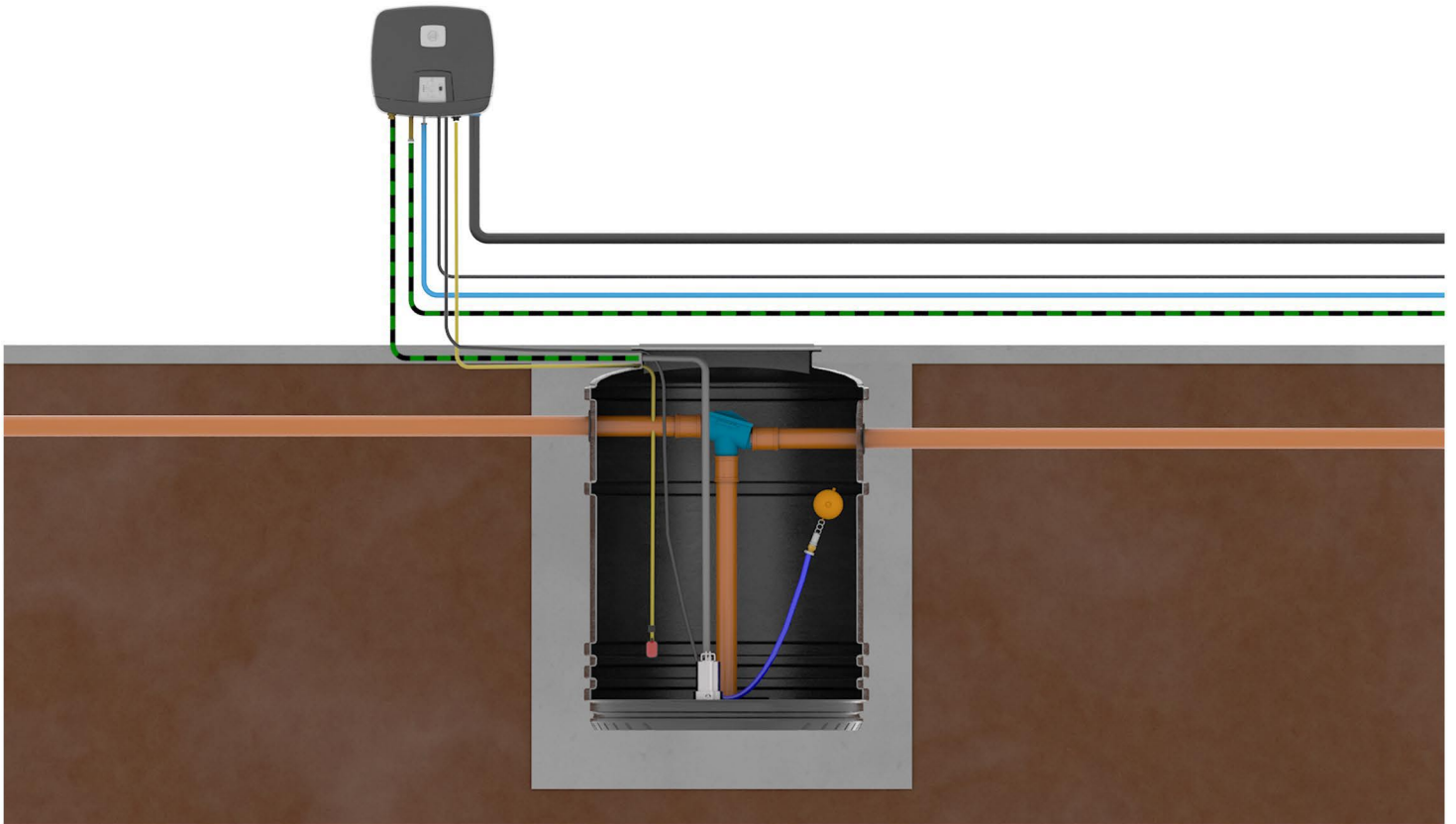

1. Rainwater inlet (Suction pipe)
2. Suction pipe to outlets
3. Drinking water in
4. Voltage 230v 50Hz / Pump In
5. Float sensor
6. Overflow pipe

## INSTALLATION CONSIDERATIONS

These Guidelines represent Best Practice for the installation of the Homestream system. It must be noted, however, that these Guidelines are of a general nature. It is the responsibility of others to verify that they are appropriate for the specific ground conditions and in-service loads of each installation.

Similarly, any information or advice given by employees or agents of the company regarding the design of an installation must be verified by a qualified specialist (e.g. Civil engineering consultant).

## WET AND DRY DESCRIPTIONS

The DPT Homestream can be installed on both 'Dry sites' and 'Wet sites'.

A 'Dry site' is a site in which the water table never rises higher than the base of the tank.

A 'Wet site' is a site where the water table may rise higher than the base of the tank but never higher than 500mm from the base of the chamber. If the water table exceeds 500mm from the base of the tank you will need consult with a drainage expert to access the best method of installation.

The Homestream is designed to collect rainwater from a domestic property to provide reusable rainwater in toilets, washing machines, and outside taps.

## DELIVERY, HANDLING, AND STORAGE

Care must be taken to ensure that the Homestream is not damaged during delivery and handling on site. Please take care and locate the system somewhere it cannot fall and become damaged.

If damage, loss, or shortage is found at the point of delivery this must be reported within 48 hours of receipt along with photographic evidence.

The design requirements of the product will frequently mean that the centre of gravity of the unit is "offset". Care must therefore be taken to ensure that the unit is stable when lifting and that loads are evenly distributed during lifting.

Lifting equipment should be selected by considering the unit weight, length and the distance of lift required on site.

We accept no responsibility for incorrect storage, lifting, or damage to equipment while stored on location.

## INSTALLATION

Select a suitable location for the chamber. This will normally be at the lowest ground level on the site so that the facilities can drain into the chamber.

Check that no other structure - or special access - is required over the selected position. Provision can be made, if necessary, to place the chamber in a roadway, provided that the backfill, cover slab, and access cover are designed in accordance with the anticipated loads.

Check that no underground cable, pipe, or service duct lies beneath the selected position.

Excavate the minimum opening in the ground to receive the pump chamber and pipework to be used. This opening must allow for a minimum of 150mm of concrete around the chamber.

The depth of the excavation needs to be at least 400mm deeper than the overall tank depth.

If a machine is used to remove the soil, then the sides of the excavation should be battered for stability and a sump left should it be necessary to dewater. If it is dug by hand, the sides will need shoring up for safety, to prevent earth slippage.

A de-watering pump may be required to control any ground water present.

The table on the following page shows the concrete pour thickness based on the diameter of the DPT range of tanks.

## INSTALLATION CONTINUED

The table below shows the concrete pour thickness based on the diameter of the DPT range of tanks.

Tank Diameter (mm)	Concrete Surround min (mm)	Concrete base Depth min (mm)
1000mm	150mm	200mm
1200mm	150mm	200mm
1500mm	150mm	200mm

Prior to laying the concrete base you will need to ensure you have laid clean hardcore to a minimum thickness of 200mm.

Tank Diameter (mm)	Hardcore Base Depth min (mm)
1000mm	200mm
1200mm	200mm
1500mm	200mm

Pour a damp concrete base to a minimum thickness of 200mm and allow to partially set (use table below for concrete grades).

Lower the chamber onto the damp concrete, allowing the base, feet, and/or mouldings to settle in. Ensure that the inlet and outlet pipes are correctly aligned for your application and that the tank is level, ready for backfill and ballast.

Fill the chamber with water to a depth of approximately 700mm, this is vital as it is imperative that the chamber is correctly ballasted prior to pouring the concrete backfill.

### **FAILURE TO DO THIS WILL RESULT IN A FAILED INSTALLATION AND POSSIBLE CHAMBER IMPLOSION.**

We recommend that the unit then should be backfilled with preferably a dry concrete, or a lean mix in areas where ground conditions are wet or unstable. A semi-dry mix can be used in dry ground conditions. The minimum surround thickness for this backfill should be 150mm.

All concrete requirements are site specific and will require evaluation prior to installation.

The concrete must be evenly poured around the tank periphery and must not exceed the depth of water in the tank. The concrete should be vibrated/compacted if needed to leave no voids.

Care must be taken to ensure that any pipes (or other connections) made are not damaged. Concrete will secure into position any pipes that have been connected. Use of supplied wall seals is mandatory.

During concrete pour, ensure that tank is vertical (by use of a spirit level across the tank's opening). Additionally, ensure that the tank is at the correct depth Allow this concrete "Anchor" to set.

**DO NOT REMOVE THE WATER FROM THE TANK THE CONCRETE MUST BE EVENLY Poured AROUND THE TANK PERIPHERY AND MUST NOT EXCEED THE DEPTH OF WATER IN THE TANK. THE WATER LEVEL SHOULD BE GRADUALLY RAISED (CONSISTENT WITH THE INCREASING LEVEL OF CONCRETE Poured) AND SHOULD REMAIN 100MM HIGHER THAN THE CONCRETE BACKFILL. LEAVE THE WATER IN THE TANK UNTIL THE CONCRETE HAS SET CURED.**



## INSTALLATION CONTINUED

Connect the site pipework to the inlet and outlet connections of the pump chamber.

In all instances the chamber must be filled with clean water to keep pace with the backfilling process, this is to equalize the pressures exerted onto the unit and prevent the possibility of chamber deformation or flotation during installation while concrete cures.

We recommend that each stage of the concrete pour should be no more than 600mm at a time, ensuring that each pour is vibrated correctly before the next pour begins, this process should be repeated until you have reached the top of the tank.

Once connections have been made you must finish the concrete pour to the top of the chamber.

(If required) construct a concrete cover slab (with access opening) of maximum 200mm thickness, ensuring that the slab is supported by consolidated backfill or utilise engineering-brick courses to the sides of the opening/manway, again these must be supported by consolidated backfill/concrete.

The access cover/frame would have been supplied unattached from the tank. Set frame onto brick courses or into concrete. If using brick courses, they should be no more than 400mm to maintain accessibility.

Construct concrete plinth for control panel kiosk (where applicable). This should include a 100mm diameter duct to the pump station to allow the passthrough of required cabling.

## STANDARD ACCESS COVER INSTALL

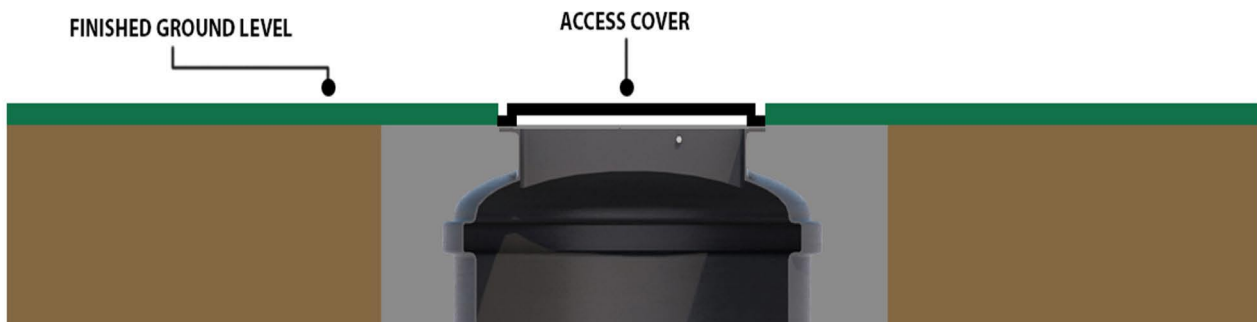

## BRICK COURSE INSTALL

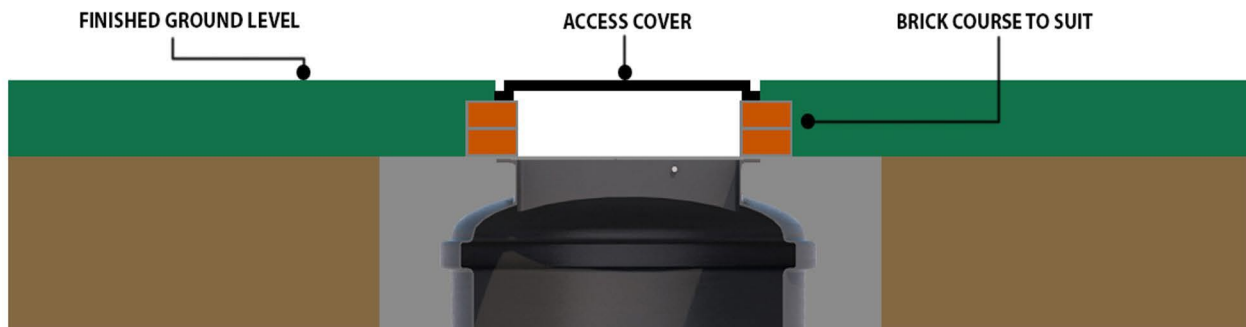

## EXAMPLE CONCRETE POUR AND BALLAST

Dig hole to correct depth as outlined in this document and lay a hardcore base and concrete slab to a minimum of 200mm each.

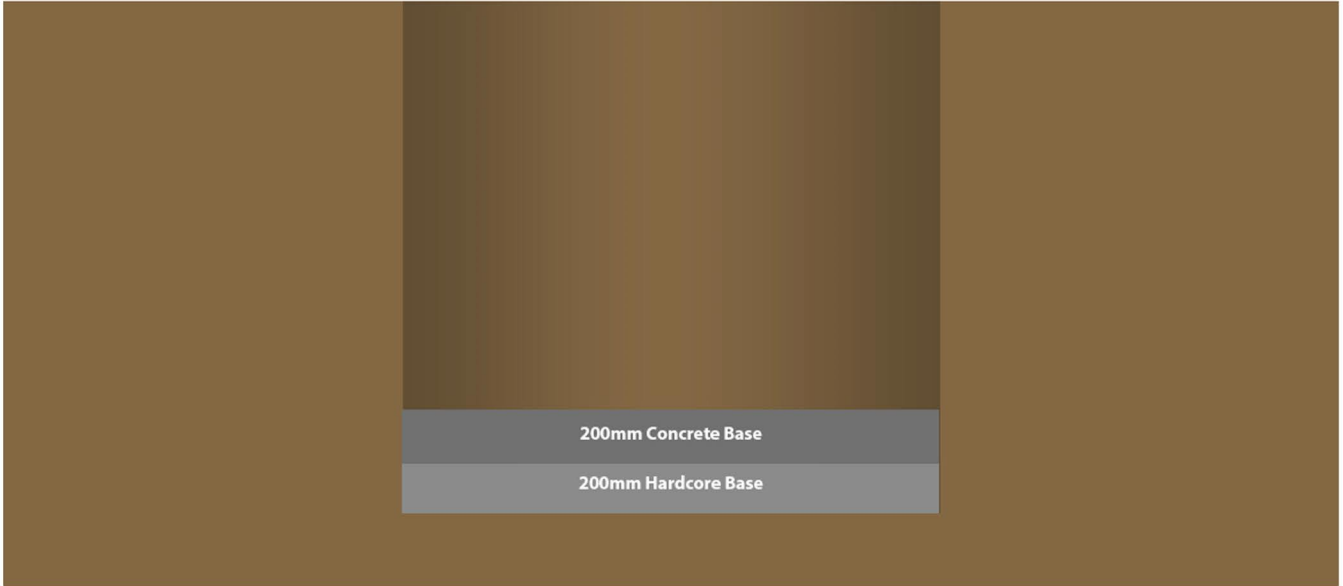

Place chamber in the center of the excavation and position firmly into the damp concrete base. Ensure the chamber is level and in the correct position.

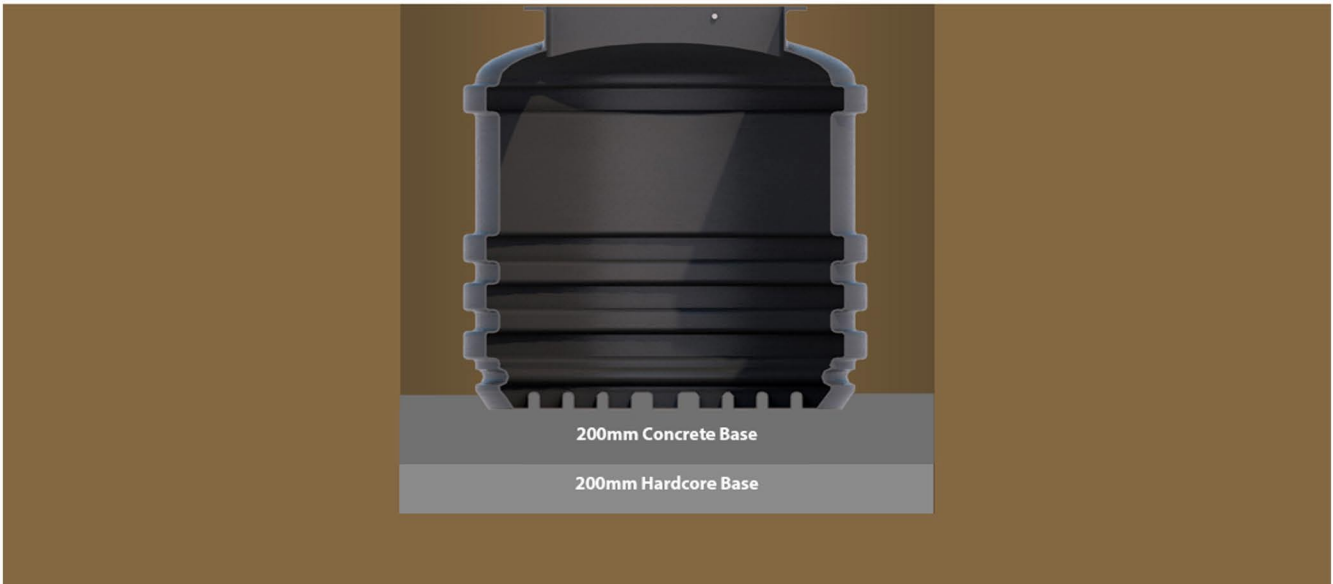

## EXAMPLE CONCRETE POUR AND BALLAST

Repeat the process for the second pour, once again ensure that the water level exceeds that of the concrete. Ensure vibration takes place at each stage of the concrete pour.

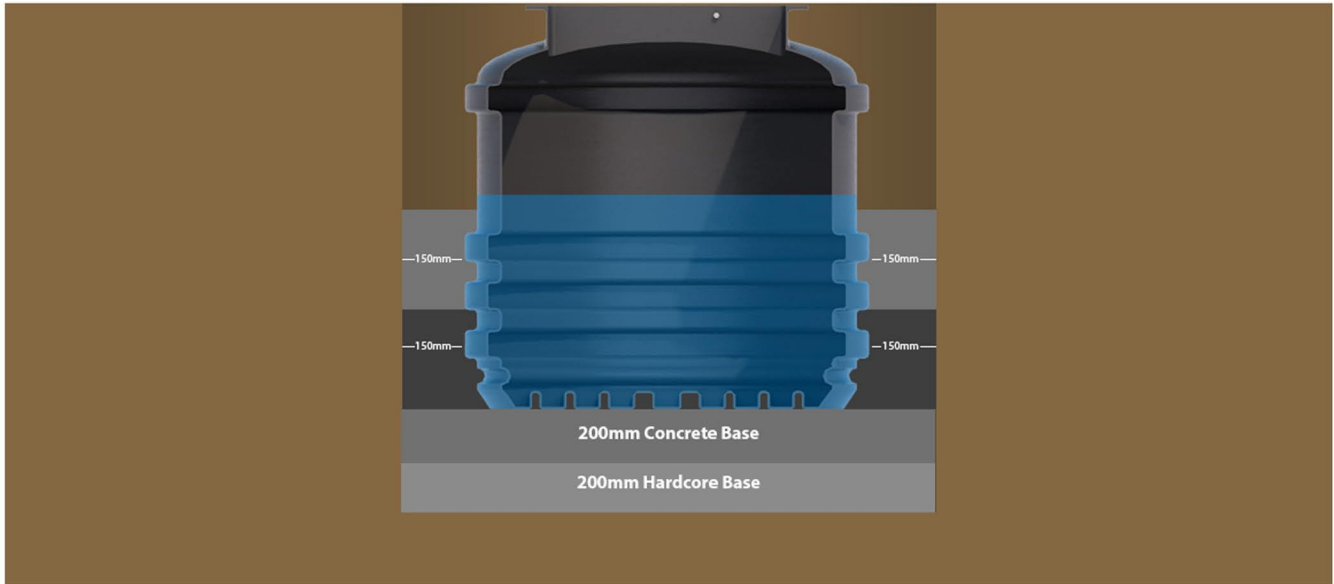

Repeat the process for the third pour, once again ensure that the water level exceeds that of the concrete. Ensure vibration takes place at each stage of the concrete pour.

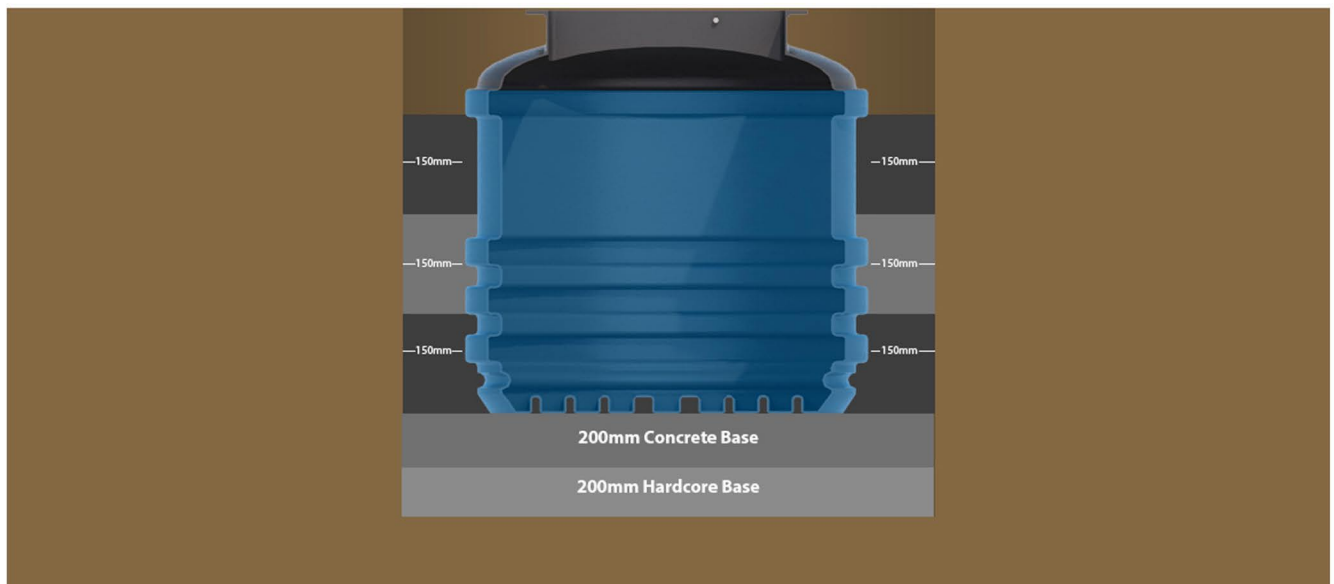

### EXAMPLE CONCRETE POUR AND BALLAST

Complete the process by laying the final pour to the surface of the chamber, take care to vibrate the concrete. Once complete you can then fix the access over in place and leave to cure.

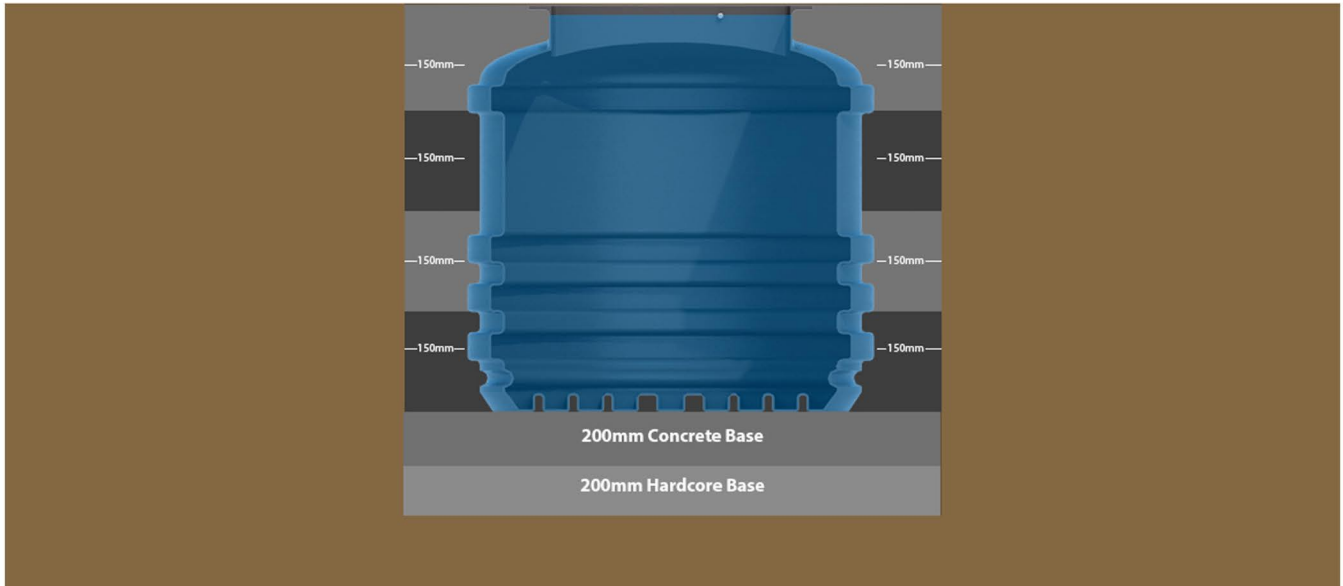

**NOTE: This is a representative example of a concrete pour, you will need to take into consideration all pipework and fixings at each stage of the pour. Chamber sizes vary and it is possible you will need many more concrete pours than outlined in this example. Although chamber sizes differ in size, capacity, and shape, the pour process remains the same for all applications.**

## IMPORTANT NOTES

Concrete Specification is not a site-specific installation design.

GENERAL CONCRETE SPECIFICATION IN ACCORDANCE WITH BS EN 206-1 (BS 8500-1)	
TYPE OF MIX	(DC) DESIGN
PERMITTED TYPE OF CEMENT	BS 12 (OPC) BS 12 (RHPC) BS 4027 (SRPC)
PERMITTED TYPE OF AGGREGATE	BS 882
NOMINAL MAXIMUM SIZE OF AGGREGATE	20mm
GRADES	C25 /30 C25 /30 C16 /20
	REINFORCED & ABOVE GROUND WITH HOLDING DOWN BOLTS REINFORCED (EG. FOR HIGH WATER TABLE) UNREINFORCED (NORMAL CONDITIONS)
MINIMUM CEMENT CONTENT	C30 C20
	270 - 280 Kg/M3 220 - 230 Kg/M3
SUMP CLASS	S1 (25mm)
RATE OF SAMPLING	READY MIX CONCRETE SHOULD BE SUPPLIED COMPLETE WITH APPROPRIATE DELIVERY TICKET IN ACCORDANCE WITH BS EN 12350-1
NOTE: STANDARD MIXES SHOULD NOT BE USED WHERE SULPHATES OR OTHER AGGRESSIVE CHEMICALS EXIST IN GROUND WATER	

When positioning the chamber please check that your electrician has provided sufficient cable to allow the isolator switch to be placed in the required position.

It is most important that once the chamber is in position, with all the inlet connections made and before starting the pumps, the drainage system is flushed through and all sand, debris etc. is removed from the chamber.

### FAILURE TO DO THIS MAY INVALIDATE THE WARRANTY ON THE SYSTEM/PRODUCT

A cable duct is required, free from sharp bends, and should be fitted on chamber 250mm from the top Ensure the cable is pulled through the duct or gland in the side of the pump chamber.

If DPT are to commission the system an adequate duct must be in place prior to visitation otherwise commissioning will not take place and further charges may be incurred.

If the chamber is going to be subjected to traffic & or vehicle loads, it is essential that a cover slab is constructed so there is no direct load onto the chamber. Also, a suitably rated access frame and cover must be obtained and installed in such a manner that no loads bear directly onto the neck of the chamber.

In all instances the pump chamber must be filled with clean water to keep pace with the backfilling process, this is to equalise the pressures exerted onto the unit and prevent the possibility of chamber deformation or flotation during installation.

All sewer connections need to comply with local water authority regulations, DPT cannot be held responsible for any retrospective changes or applications rejected by local water authorities due to incorrect discharge rates.

The installer is responsible for all site work, it is their responsibility to review this document and make any required changes to the site-specific project if conditions require modification. DPT are not responsible for any changes made.

### IF IN DOUBT PLEASE CONTACT US FOR ADVICE.

**IT SHOULD BE NOTED THAT THIS INFORMATION IS FOR GUIDANCE PURPOSES ONLY. IT IS THE RESPONSIBILITY OF THE CONTRACTOR TO ENSURE THAT THE INSTALLATION IS CARRIED OUT TO THE SATISFACTION OF YOUR REGULATING LOCAL WATER AUTHORITY, IN ACCORDANCE WITH THE PREVAILING GROUND CONDITIONS.**