

# ELECTRONIC SOLUTIONS FOR CONTROL & PROTECTION OF SINGLE PHASE PUMPS

IP65  
Enclosure

3 PIECES UNION  
Integrated

NON-RETURN VALVE  
built-in

WATER ACCUMULATOR  
built-in

TROPICALIZED  
electronic board

FREE POSITIONING  
vertical, horizontal  
or at any angle

'EXCESSIVELY FREQUENT STARTS' protection  
with auto reset

'DRY RUN' protection  
with auto reset

**DG  
FLOW**

**PRESFLO starts and stops the pump  
It substitutes traditional pressure switch/surge tank  
systems while offering important advantages**

# PRODUCT LINE, FEATURES & OPTIONALS



**PRESFLO**  
**SIMPLICITY**  
Fix start pressure











**PRESFLO VARIO**  
**VERSATILITY**  
Adjustable start pressure

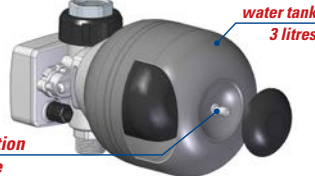

**PRESFLO MULTI**  
**COMFORT**  
- Adjustable start pressure  
- 3 litres tank  
- Overcurrent protection

## DIFFERENCES between models :

<p><b>Water accumulator type</b></p>	<p><b>"SPRING-MEMBRANE" water tank</b></p> <ul style="list-style-type: none"> <li>- "No ordinary maintenance required"</li> <li>- "Engineered for long-life"</li> </ul> 	<p><b>"SPRING-MEMBRANE" water tank</b></p> <ul style="list-style-type: none"> <li>- "No ordinary maintenance required"</li> <li>- "Engineered for long-life"</li> <li>- Same water volume at different start pressure</li> </ul> 	<p><b>"DIAPHRAGM" water tank</b></p> <p>The tank is pre-loaded at 1.5 bar and has a capacity of 3 litres. It guarantees a comfortable accumulation volume, and it reduces the frequency of pump starts in the presence of leakages.</p>  <p>water tank 3 litres Inflation valve</p>
<p><b>Start Pressure (cut-in pressure)</b></p>	<p><b>FIX "START PRESSURE"</b></p> <p>3 models, each one with a factory preset value</p>  <p>0,8 bar 1,5 bar 2,2 bar</p>	<p><b>ADJUSTABLE "START PRESSURE"</b></p> <p>Easily and intuitively by means of the rotary control knob.</p>  <p>0,8 bar 2,4 bar</p> <p>Range: 0,8 bars ÷ 2,4 bars</p>	<p><b>ADJUSTABLE "START PRESSURE"</b></p> <p>Easily and intuitively by turning a screw. You may use the supplied screw driver (pic.A)</p>  <p>A</p> <p>Pressure value is detected by an electronic pressure sensor.</p>  <p>Range: 1bars ÷ 5 bars</p>
<p><b>Max. Pump Power</b></p>	<p><b>PRESFLO 12: 1,5 Hp max pump power</b></p> <p><b>PRESFLO 16: 2,0 Hp max pump power</b></p>	<p><b>PRESFLO VARIO: 2,0 Hp max pump power</b></p>	<p><b>PRESFLO MULTI: 2,0 Hp max pump power</b></p> <p>Equipped with overload protection. The protection setting is easy by simply and intuitively turning a screw (pic.B)</p>  <p>B</p>

## KEY FEATURES COMMON ON ALL MODELS :

**3 PIECES UNION integrated**



Avoiding the need of expensive 3 pieces unions.

**NON-RETURN VALVE built-in and inspectionable**

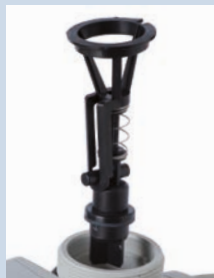

Avoid the need to install one

**PRESSURE GAUGE easy-to-add**



OPTIONAL: it can be added anytime.

**FREE POSITIONING vertical, horizontal or at any angle**



Thanks to the spring loaded valve.

**PROTECTIVE COVER FOR ELECTRIC PARTS**



To prevent damages during installation.

**IP65 enclosure:**  
able to protect against water jets

**DRY RUN protection**  
with automatic reset

**EXCESSIVELY FREQUENT STARTS protection.**  
Prevent pump overheating and damages. (PATENTED)

**LOW HEAD LOSSES.**  
the most performant on market today  
0.3 bars at 100 lt/min

**TROPICALIZED ELECTRONIC**  
it saves and prolongs life of the electronic components.



## PUMP MATCHING - ESSENTIAL CHECK

Carefully check the electric and hydraulic features and make sure they comply with those of the pump and the system, but in particular:

- Presflo 0.8 bars start pressure requires :**
  - pump head of at least 1.8 bars &
  - the water column between the device and the highest user point must not exceed 8 mtrs - less 2 mtrs tolerance = 6 mtrs (see picture : H)  
(otherwise raise control until conditions are fulfilled)
- Presflo 1.5 bars start pressure requires :**
  - pump head of at least 2.5 bars &
  - the water column between the device and the highest user point must not exceed 15 mtrs - less 2 mtrs tolerance = 13 mtrs (see picture : H)  
(otherwise raise control until conditions are fulfilled)
- Presflo 2.2 bars start pressure requires :**
  - pump head of at least 3.2 bars &
  - the water column between the device and the highest user point must not exceed 22 mtrs - less 2 mtrs tolerance = 20 mtrs (see picture : H)  
(otherwise raise control until conditions are fulfilled)

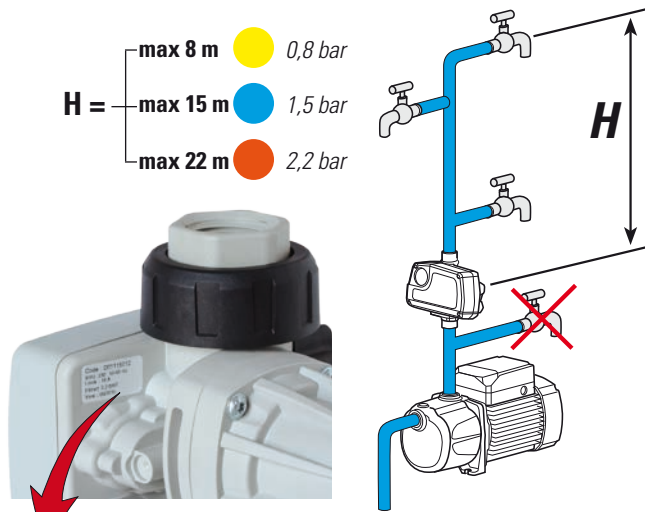

## HEAD LOSSES

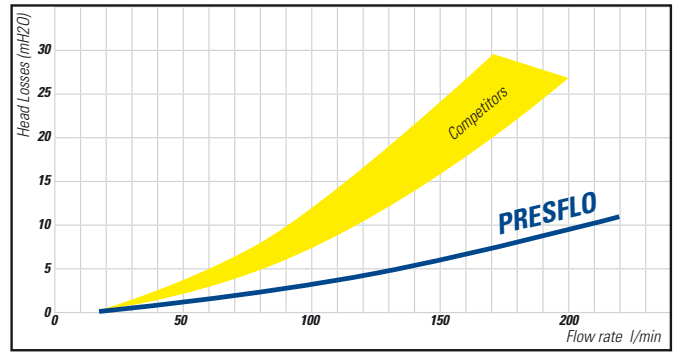

## DIMENSIONS

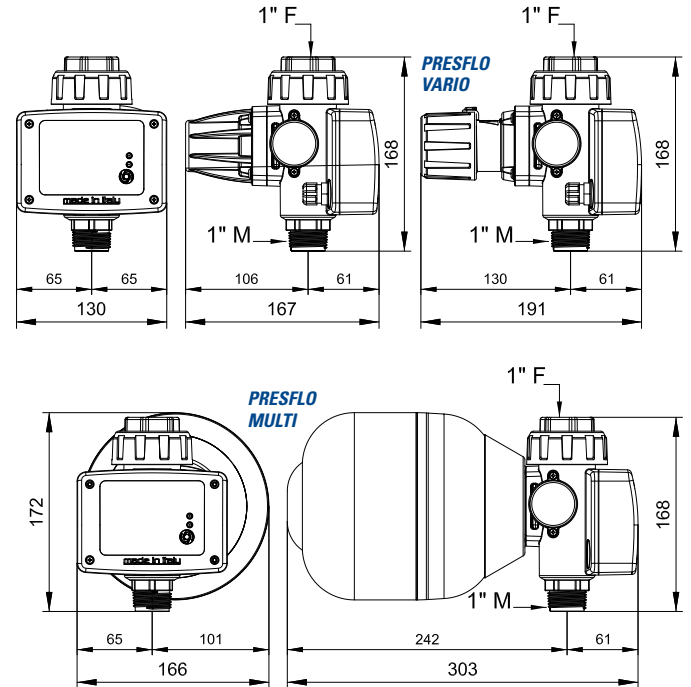

Models	Max. pump power		Start pressure bar	Max. current A	Water storage	Protections			Voltage V	Frequency Hz	Connections	cut-off flow rate	IP protection
	Kw	Hp				dry run	frequent starts	over current					
<b>PRESFLO</b>													
PF 1208	1,1	1,5	0,8	12	spring membrane	•	•		230	50/60	1" BSP	2 l/min	IP 65
PF 1215	1,1	1,5	1,5	12		•	•						
PF 1222	1,1	1,5	2,2	12		•	•						
PF 1615	1,5	2,0	1,5	16		•	•						
PF 1622	1,5	2,0	2,2	16		•	•						
<b>PRESFLO VARIO</b>													
PFV 12	1,1	1,5	0,8 - 2,4	12	spring membrane	•	•		230	50/60	1" BSP	2 l/min	IP 65
PFV 16	1,5	2,0	0,8 - 2,4	16		•	•						
<b>PRESFLO MULTI</b>													
PM 16	1,5	2,0	1,0 - 5,0	16	3 ltrs tank	•	•	•	230	50/60	1" BSP	2 l/min	IP 65

\*110 Volts and NPT connection available on request



**DGFLOW srl**  
Via Emilia, 5 - 46030 Bigarello (Mantova) Italy  
tel. +39 0376 340922 - fax. +39 0376 249525  
info@dgflow.it - www.dgflow.it