

**ASSEMBLY INSTRUCTIONS**  
FOR  
**1999-PRESENT GM 1500 SERIES TRUCKS/SUVS \***  
\*For additional vehicle compatibility, visit [www.wilwood.com](http://www.wilwood.com)

**AEROLITE 6 DIRECT MOUNT FRONT BRAKE KIT  
WITH 13.38" VENTED ROTORS AND FLEXLINES**

BASE PART NUMBERS

- **140-16803** (1999-2006 GM 1500)
- **140-16804** (2007-2018 GM 1500)
- **140-16805** (2019-PRESENT GM 1500)

**DISC BRAKES SHOULD ONLY BE INSTALLED BY SOMEONE  
EXPERIENCED AND COMPETENT IN THE INSTALLATION AND  
MAINTENANCE OF DISC BRAKES  
READ ALL WARNINGS**

**WARNING**

IT IS THE RESPONSIBILITY OF THE PERSON INSTALLING ANY BRAKE COMPONENT OR KIT TO DETERMINE THE SUITABILITY OF THE COMPONENT OR KIT FOR THAT PARTICULAR APPLICATION. IF YOU ARE NOT SURE HOW TO SAFELY USE THIS BRAKE COMPONENT OR KIT, YOU SHOULD NOT INSTALL OR USE IT. DO NOT ASSUME ANYTHING. IMPROPERLY INSTALLED OR MAINTAINED BRAKES ARE DANGEROUS. IF YOU ARE NOT SURE, GET HELP OR RETURN THE PRODUCT. YOU MAY OBTAIN ADDITIONAL INFORMATION AND TECHNICAL SUPPORT BY CALLING WILWOOD AT (805) 388-1188, OR VISIT OUR WEB SITE AT [WWW.WILWOOD.COM](http://WWW.WILWOOD.COM). USE OF WILWOOD TECHNICAL SUPPORT DOES NOT GUARANTEE PROPER INSTALLATION. YOU, OR THE PERSON WHO DOES THE INSTALLATION MUST KNOW HOW TO PROPERLY USE THIS PRODUCT. IT IS NOT POSSIBLE OVER THE PHONE TO UNDERSTAND OR FORESEE ALL THE ISSUES THAT MIGHT ARISE IN YOUR INSTALLATION.

RACING EQUIPMENT AND BRAKES MUST BE MAINTAINED AND SHOULD BE CHECKED REGULARLY FOR FATIGUE, DAMAGE, AND WEAR.



Need Additional Information? Use Your  
SmartPhone and Jump to Our Technical  
Tips Section on Our Web Site.



**WARNING**

**DO NOT OPERATE ANY VEHICLE ON UNTESTED BRAKES!**  
**SEE MINIMUM TEST PROCEDURE WITHIN**

ALWAYS UTILIZE SAFETY RESTRAINT SYSTEMS AND ALL OTHER AVAILABLE SAFETY EQUIPMENT WHILE OPERATING THE VEHICLE

**IMPORTANT • READ THE DISCLAIMER OF WARRANTY INCLUDED IN THE KIT**

NOTE: Some cleaners may stain or remove the finish on brake system components. Test the cleaner on a hidden portion of the component before general use.

## Important Notice - Read This First

Before any tear-down or disassembly begins, review the following information:

- **Important:** Before assembling this kit, see “Modification Instructions” on page 4 for information on clearing the dust shield on some models for proper caliper mounting.
- Review the Wheel Clearance Diagram (Figure 2, page 3) to verify that there is adequate clearance with the wheels you will be using with the installation.
- Vehicles equipped with electric parking brakes should be placed into brake “service” or “maintenance” mode prior to start of brake kit installation. Follow OEM procedures to activate brake service mode.
- Due to OEM production differences and other variations from vehicle to vehicle, the fastener hardware and other components in this kit may not be suitable for a specific application or vehicle.
- It is the responsibility of the purchaser and installer of this kit to verify suitability / fitment of all components and ensure all fasteners and hardware achieve complete and proper engagement. Improper or inadequate engagement can lead to component failure.

## Photographic Tip

**Important** and highly recommended: Take photos of brake system before disassembly and during the disassembly process. In the event, trouble-shooting photos can be life savers. Many vehicles have undocumented variations, photos will make it much simpler for Wilwood to assist you if you have a problem.

## Exploded Assembly Diagram

**WARNING**  
INSTALLATION OF THIS KIT SHOULD ONLY BE PERFORMED BY PERSONS EXPERIENCED IN THE INSTALLATION AND PROPER OPERATION OF DISC BRAKE SYSTEMS.

**NOTE**  
SPECIFIC PARTS MAY VARY FROM DIAGRAM

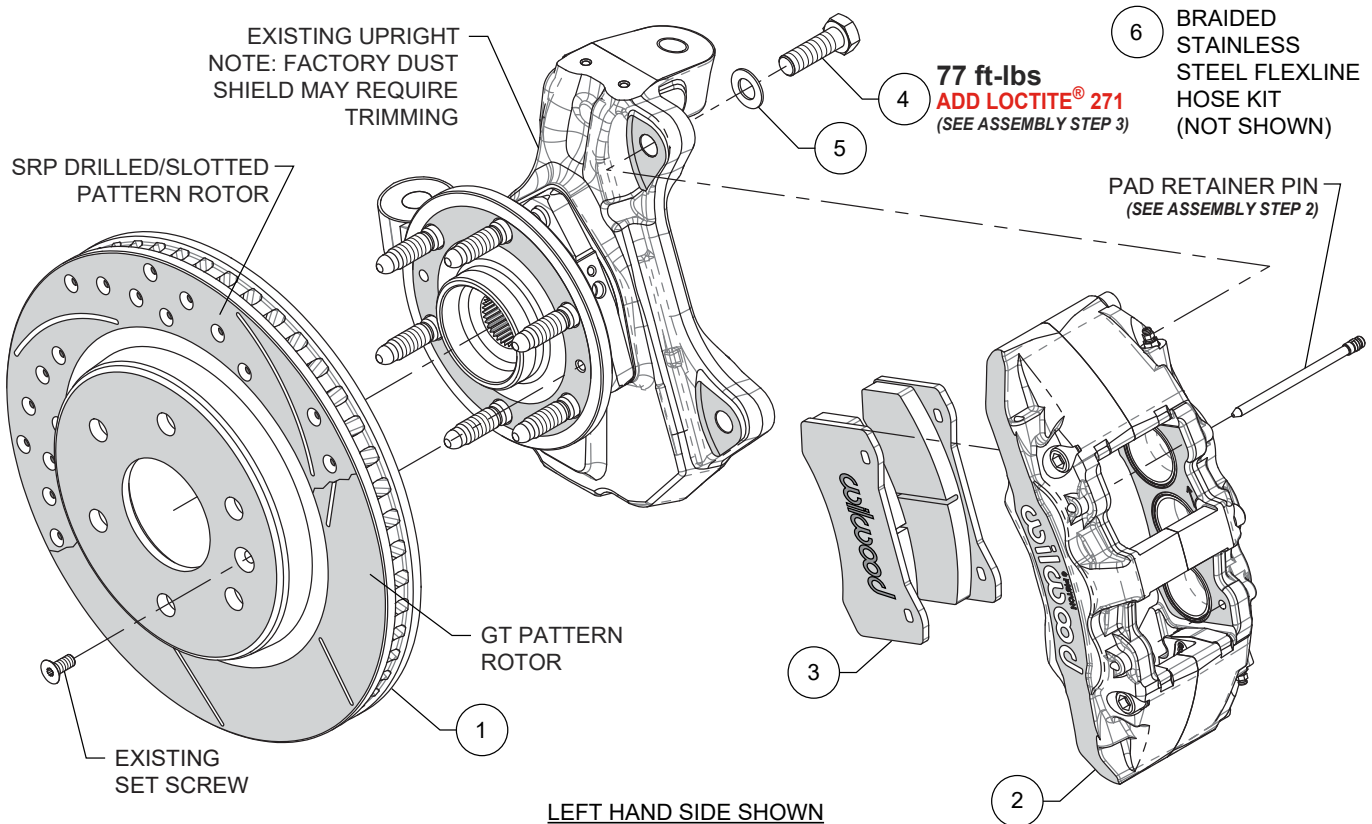

Figure 1. Typical Installation Configuration

## Parts List

ITEM NO.	PART NO.	DESCRIPTION	QTY
1	160-16511-GTB	Rotor, GT, 13.38" Dia. x 1.25" Thick, 6 x 5.50" Bolt Pattern	2
1A	160-16512/13-BK	Rotor, SRP Drilled & Slotted (one each, right & left)	2
2	120-16823/24-BK	Caliper, Aerolite 6, DM, Black (one each right & left) <b>included with p/ns 140-16803/04</b>	2
2A	120-16823/24-RD	Caliper, Aerolite 6, DM, Red (one each right & left) <b>option for p/ns 140-16803/04</b>	2
2	120-16825/26-BK	Caliper, Aerolite 6, DM, Black (one each right & left) <b>included with p/n 140-16805</b>	2
2B	120-16825/26-RD	Caliper, Aerolite 6, DM, Red (one each right & left) <b>option for p/n 140-16805</b>	2
3	150-Q-6617K	Pad, Q Compound, Axle Set	1
4	230-13152	Bolt, M14-2.00 x 45mm Long, Hex Head	4
5	240-11855	Washer, .578" I.D. x 1.062" O.D. x .063" Thick	4
6	220-17129	Braided Stainless Steel Flexline Hose Kit (not shown), <b>incl. with p/n 140-16803</b>	1
6	220-10979	Braided Stainless Steel Flexline Hose Kit (not shown), <b>incl. with p/n 140-16804</b>	1
6	220-10979	Braided Stainless Steel Flexline Hose Kit (not shown), <b>incl. with p/n 140-16805</b>	1

NOTES: Part Number 230-17073 Caliper Bolt Kit, includes part numbers 230-13152 and 240-11855

Item 1A is an optional item and is included with the (D) drilled rotor kits. Add "-D" to end of part number when ordering.

Items 2A & 2B are optional items and are included with the (R) red caliper kits. Add "-R" to end of part number when ordering.

## General Information

- Installation of this kit should **ONLY** be performed by persons experienced in the installation and proper operation of disc brake systems. Before assembling this Wilwood disc brake kit, double check the following to ensure a trouble free installation.
- Inspect the contents of this kit against the parts list to ensure that all components and hardware are included.
- Make sure this is the correct kit to fit the exact make and model year of your vehicle. This kit is designed for direct bolt-on installation to one of the following:
  - 1999 to 2006 GM 1500, p/n **140-16803**
  - 2007 to 2018 GM 1500 p/n **140-16804**
  - 2019 to Present GM 1500 p/n **140-16805**
- Verify your wheel clearance using Figure 2.
- Verify the wheel stud pattern of the new rotor in this kit matches the lug pattern of the vehicle's wheels.

## Disassembly Instructions

- Disassemble the original equipment front brakes:

Raise the front wheels off the ground and support the front suspension according to the vehicle manufacturer's instructions.

Remove the front wheels, calipers, rotors, and brake hoses.

• **NOTE:** The OEM pad wear sensor is not used with the new Wilwood calipers. To prevent warning messages from displaying, the sensor wire must remain on the vehicle. Coil up the wire and securely strap it in an out of the way location, away from any moving or rotating components.

- Remove any nicks or burrs on the hub, upright, and caliper mounting bosses that may interfere with the installation of the new brake components.
- Clean and de-grease the hub, upright, and caliper mounting bosses.

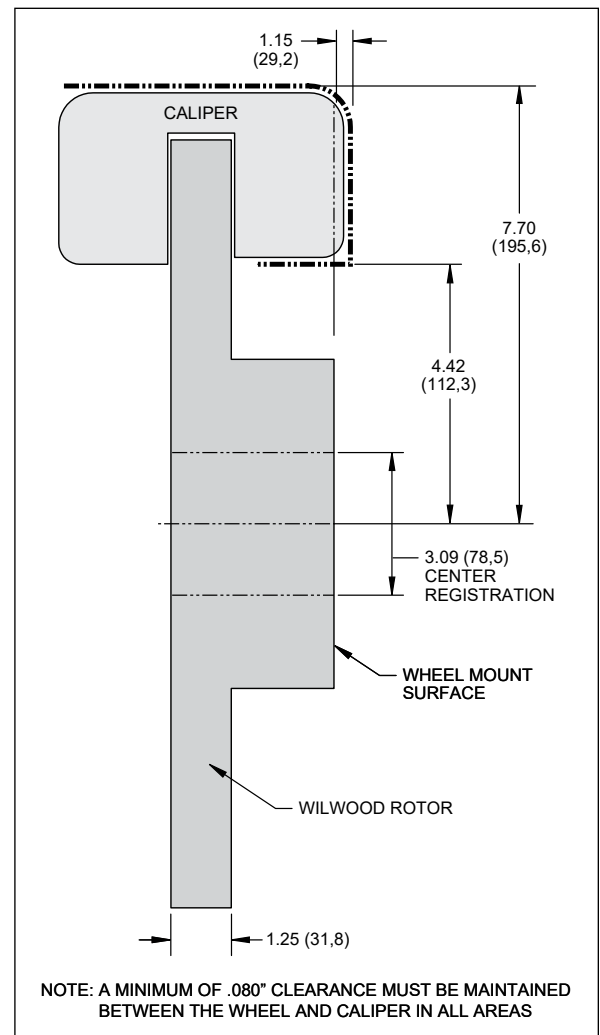
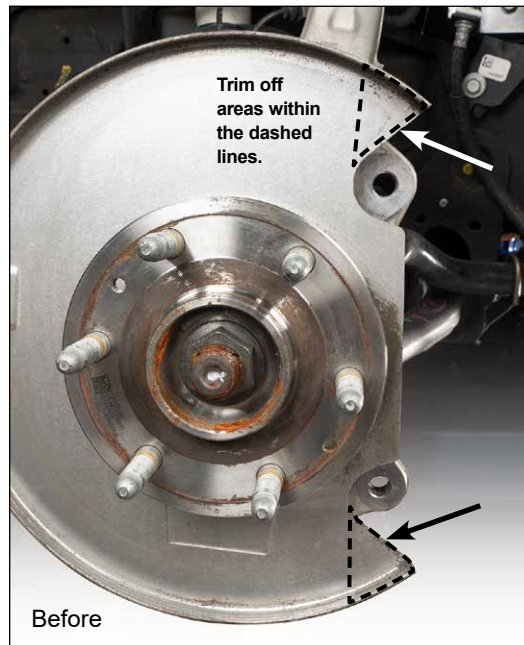

Figure 2. Wheel Clearance Diagram

## Modification Instructions

•**NOTE:** On certain GM 1500 vehicles, some trimming of the dust shield is required for proper fitment of new caliper. Only trim off enough material to provide adequate clearance so that the Wilwood caliper does not touch the dust shield and properly attaches to OEM caliper mount bosses without any interference. See approximate areas to be trimmed in Photos A and B at right.



Before

Photo A



After

Photo B

## Assembly Instructions

Numbers in parenthesis refer to the parts list and Figure 1 on the preceding pages.

•**NOTE:** Vehicles equipped with electric parking brakes should be placed into brake "service" or "maintenance" mode prior to start of brake kit installation. Follow OEM procedures to activate brake service mode.

**STEP 1** Slide the rotor (1) onto the hub. **NOTE:** The rotor must fit flush against the hub flange or excessive rotor run out may result. Install the OEM set screw to keep the rotor in place while continuing with the installation, Figure 1 and Photo 1.



Photo 1

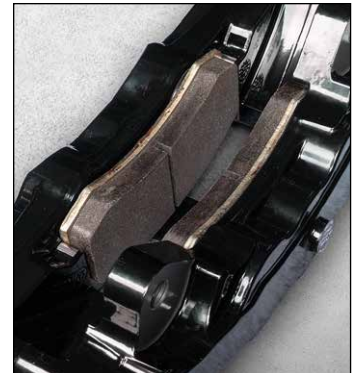

Photo 2

**STEP 2** Remove the two pad retaining pins from the caliper (2). Insert the brake pads (3) into the caliper, with the friction material facing the rotor, as shown in Photo 2. Secure the brake pads in place with the pad retaining pins, Figure 1 and Photo 3. **CAUTION:** Ensure pad retaining pins are completely engaged into caliper, Photo 4. It is recommended to use a small flat punch and hammer to tap the pins in until they are fully seated.

**STEP 3** **NOTE:** This kit contains distinct right and left hand calipers that must be mounted in a specific direction, as described below. Ensure that the caliper is mounted so the largest pistons are at the rotor exit end of the caliper, in relation to the direction of the rotor. Mount the caliper (2) onto the OEM caliper mounting bosses using bolts (4) and washers (5), as shown in Figure 1 and Photo 5. Apply red Loctite® 271 to bolt threads, and torque to value shown in Figure 1.



Photo 3



Photo 4

## Assembly Instructions (Continued)

**STEP 4** Temporarily install the wheel and torque the lug nuts to the manufacturer's specification. Ensure that the wheel rotates freely without any interference. Remove wheel for the next step.

**STEP 5** Attach brake line to caliper. **NOTE:** OEM rubber brake hoses generally cannot be adapted to Wilwood calipers. Install Wilwood's stainless steel braided flexline hose kit (6) that is included with this kit. See below for more info on flexline kits.

•**1999-2006 GM 1500** uses flexline kit p/n 220-17129

•**2007-2018 GM 1500** uses flexline kit p/n 220-10979

•**2019-Present GM 1500** uses flexline kit p/n 220-10979

The caliper inlet fitting is a 1/8-27 NPT. Use the included steel adapter fitting at the caliper (use PTFE tape on the pipe threads of adapter fitting for proper sealing to caliper).

•**For 1999-2006 GM 1500 (p/n 140-16803):** Route new flexline as shown in Photo 7a. Use the included clamps in flexline kit (p/n 220-17129) to attach new flexline to upright at locations shown, Photos 7b, 7c. OEM bracket shown in 7b (arrow) requires prying open approximately as shown to remove OEM brake hose and create room for the new clamp.

•**For 2007-Present GM 1500 (p/n 140-16804 / 140-16805):** Route new flexline (p/n 220-10979) as shown in Photo 8. Reuse OEM flexline bracket by recrimping clamp just enough to hold new flexline. Be careful not to pinch or crimp brake hose. **NOTE:** The OEM pad wear sensor is not used with the new Wilwood calipers. To prevent warning messages from displaying, the sensor wire must remain on the vehicle. Coil up the wire and securely strap it in an out of the way location, away from any moving or rotating components.

•**Ensure hoses are routed to prevent contact with moving suspension, brake or wheel components.**

•**NOTE:** Wilwood hose kits are designed for use in many different vehicle applications and it is the installer's responsibility to properly route and provide adequate clearance and retention for brake hose components.

•**NOTE:** Specified brake hose kits may not work with all Years, Makes and Models of vehicle that this brake kit is applicable to, due to possible OEM manufacturing changes during a production vehicle's life.

•**CAUTION:** In absence of specific instructions for brake line routing, the installer must use his best professional judgment on correct routing and retention of lines to ensure safe operation. It is the installer's responsibility to ensure that all fittings and hoses are the correct size and length, properly seal, and that they will not be subject to crimping, strain and abrasion from vibration or interference with suspension components, brake rotor or wheel.

**STEP 6** Bleed the brake system, referring to the 'Additional Information and Recommendations' on page 7 for proper bleeding instructions. Check system for leaks after bleeding.



Photo 5



Photo 6

**STEP 7** Install the wheel and torque the lug nuts to manufacturer's specifications.

•**CAUTION:** Test vehicle brake system per the 'Minimum Test Procedure' stated within this document before driving. After road testing, inspect for leaks and interference. Initially after install and testing, perform frequent checks of the vehicle brake system and lines before driving, to confirm that there is no undue wear or interference not apparent from the initial test. Afterwards, perform periodic inspections for function, leaks and wear in an interval relative to the usage of vehicle.

**STEP 8** Bed-in the brake pads per the procedure on page 8.

## Assembly Instructions (Continued)

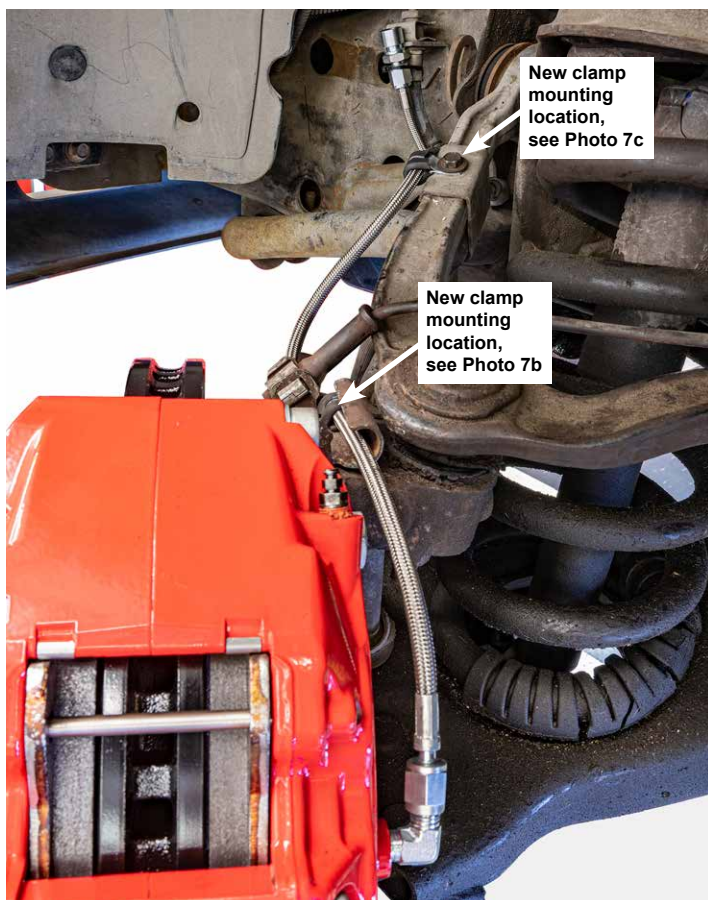

Photo 7a

1999 - 2006 GM 1500 flexline routing, p/n 220-17129

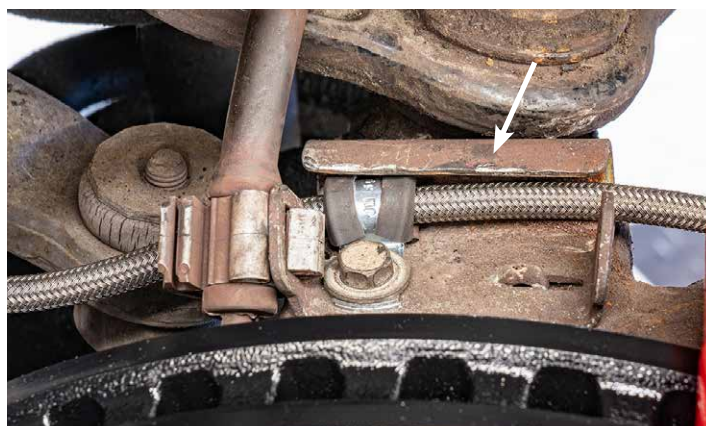

Photo 7b

1999 - 2006 GM 1500 flexline clamp, p/n 220-17129

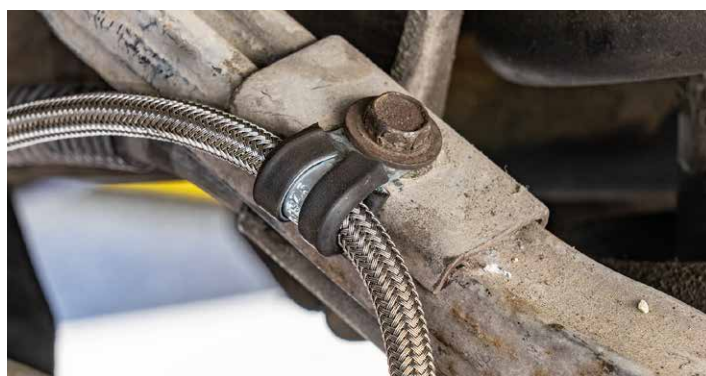

Photo 7c

1999 - 2006 GM 1500 flexline clamp, p/n 220-17129

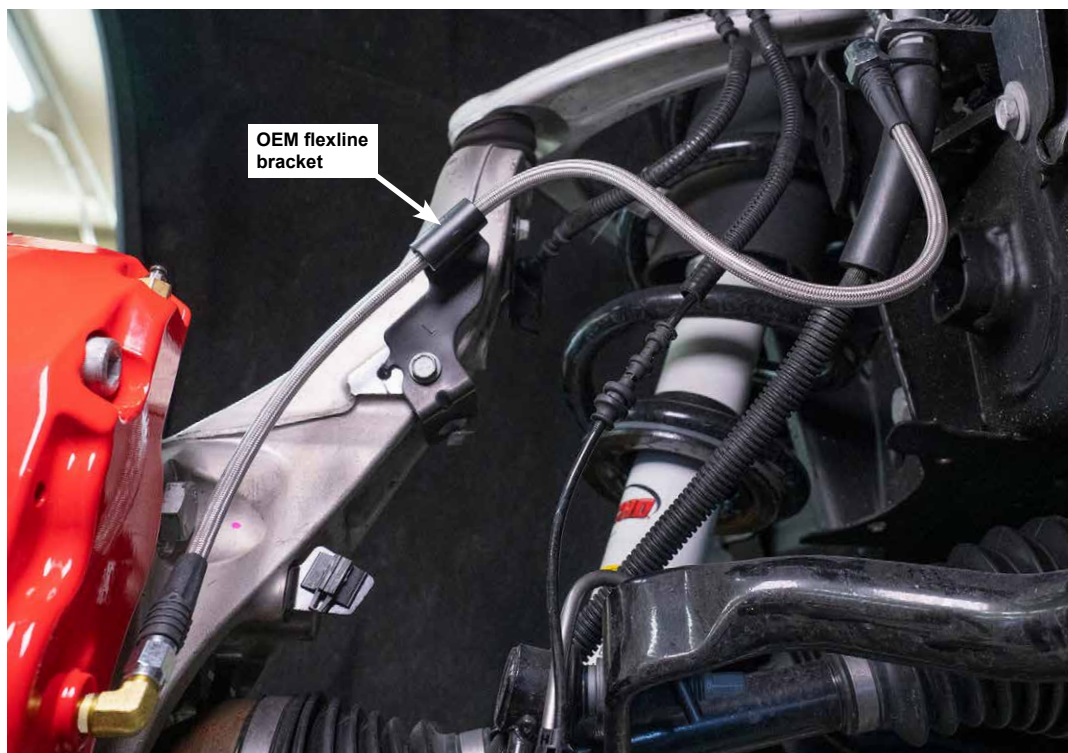

Photo 8

2007 - Present GM 1500 flexline routing, p/n 220-10979

## Additional Information and Recommendations

• Fill and bleed the new system with Wilwood Hi-Temp<sup>®</sup> 570 grade fluid or higher. For severe braking or sustained high heat operation, use Wilwood EXP 600 Plus Racing Brake Fluid. Used fluid must be completely flushed from the system to prevent contamination. **NOTE:** *Silicone DOT 5 brake fluid is **NOT** recommended for racing or performance driving.*

• To properly bleed the brake system, begin with the caliper farthest from the master cylinder. Bleed the outboard bleed screw first, then the inboard. Repeat the procedure until all calipers in the system are bled, ending with the caliper closest to the master cylinder. **NOTE:** *When using a new master cylinder, it is important to bench bleed the master cylinder first.*

• Test the brake pedal. It should be firm, not spongy and stop at least 1 inch from the floor under heavy load.

If the brake pedal is spongy, bleed the system again.

If the brake pedal is initially firm, but then sinks to the floor, check the system for fluid leaks. Correct the leaks (if applicable) and then bleed the system again.

If the brake pedal goes to the floor and continued bleeding of the system does not correct the problem, a master cylinder with increased capacity (larger bore diameter) may be required. Wilwood offers various lightweight master cylinders with large fluid displacement capacities.

• **NOTE:** *With the installation of after market disc brakes, the wheel track may change depending on the application. Check your wheel offset before final assembly.*

• If after following the instructions, you still have difficulty in assembling or bleeding your Wilwood disc brakes, consult your local chassis builder, or retailer where the kit was purchased for further assistance. Additional information is also available on our web site at [www.wilwood.com](http://www.wilwood.com), or e-mail technical assistance: [info@wilwood.com](mailto:info@wilwood.com).

## Brake Testing

### **WARNING • DO NOT DRIVE ON UNTESTED BRAKES BRAKES MUST BE TESTED AFTER INSTALLATION OR MAINTENANCE MINIMUM TEST PROCEDURE**

- Make sure pedal is firm: Hold firm pressure on pedal for several minutes, it should remain in position without sinking. If pedal sinks toward floor, check system for fluid leaks. DO NOT drive vehicle if pedal does not stay firm or can be pushed to the floor with normal pressure.
- At very low speed (2-5 mph) apply brakes hard several times while turning steering from full left to full right, repeat several times. Remove the wheels and check that components are not touching, rubbing, or leaking.
- Carefully examine all brake components, brake lines, and fittings for leaks and interference.
- Make sure there is no interference with wheels or suspension components.
- Drive vehicle at low speed (15-20 mph) making moderate and hard stops. Brakes should feel normal and positive. Again check for leaks and interference.
- Always test vehicle in a safe place where there is no danger to (or from) other people or vehicles.
- Always wear seat belts and make use of all safety equipment.

## Pad and Rotor Bedding

### BEDDING STEPS FOR NEW PADS AND ROTORS – ALL COMPOUNDS

Once the brake system has been tested and determined safe to operate the vehicle, follow these steps for the bedding of all new pad materials and rotors. These procedures should only be performed on a race track, or other safe location where you can safely and legally obtain speeds up to 65 MPH, while also being able to rapidly decelerate.

- Begin with a series of light decelerations to gradually build some heat in the brakes. Use an on-and-off the pedal technique by applying the brakes for 3-5 seconds, and then allow them to fully release for a period roughly twice as long as the deceleration cycle. If you use a 5 count during the deceleration interval, use a 10 count during the release to allow the heat to sink into the pads and rotors.
- After several cycles of light stops to begin warming the brakes, proceed with a series of medium to firm deceleration stops to continue raising the temperature level in the brakes.
- Finish the bedding cycle with a series of 8-10 hard decelerations from 55-65 MPH down to 25 MPH while allowing a proportionate release and heat-sinking interval between each stop. The pads should now be providing positive and consistent response.
- If any amount of brake fade is observed during the bed-in cycle, immediately begin the cool down cycle.
- Drive at a moderate cruising speed, with the least amount of brake contact possible, until most of the heat has dissipated from the brakes. Avoid sitting stopped with the brake pedal depressed to hold the car in place during this time. Park the vehicle and allow the brakes to cool to ambient air temperature.

### COMPETITION VEHICLES

- If your race car is equipped with brake cooling ducts, blocking them will allow the pads and rotors to warm up quicker and speed up the bedding process.
- Temperature indicating paint on the rotor and pad edges can provide valuable data regarding observed temperatures during the bedding process and subsequent on-track sessions. This information can be highly beneficial when evaluating pad compounds and cooling efficiencies.

### POST-BEDDING INSPECTION – ALL VEHICLES

- After the bedding cycle, the rotors should exhibit a uniformly burnished finish across the entire contact face. Any surface irregularities that appear as smearing or splotching on the rotor faces can be an indication that the brakes were brought up to temperature too quickly during the bedding cycle. If the smear doesn't blend away after the next run-in cycle, or if chatter under braking results, sanding or resurfacing the rotors will be required to restore a uniform surface for pad contact.

### PRE-RACE WARM UP

- Always make every effort to get heat into the brakes prior to each event. Use an on-and-off the pedal practice to warm the brakes during the trip to the staging zone, during parade laps before the flag drops, and every other opportunity in an effort to build heat in the pads and rotors. This will help to ensure best consistency, performance, and durability from your brakes.

### DYNO BEDDED COMPETITION PADS AND ROTORS

- Getting track time for a proper pad and rotor bedding session can be difficult. Wilwood offers factory dyno-bedded pads and rotors on many of our popular competition pads and **Spec 37** GT series rotors. Dyno-bedded parts are ready to race on their first warm up cycle. This can save valuable time and effort when on-track time is either too valuable or not available at all, Dyno-bedding assures that your pads and rotors have been properly run-in and are ready to go. Contact your dealer or the factory for more information on Wilwood Dyno-Bedding services.

**NOTE:** NEVER allow the contact surfaces of the pads or rotors to be contaminated with brake fluid. Always use a catch bottle with a hose to prevent fluid spill during all brake bleeding procedures.



## Connect with Wilwood

Wilwood Facebook



Wilwood Instagram



Wilwood Twitter



Wilwood YouTube



## Associated Components

<b><u>PART NO.</u></b>	<b><u>DESCRIPTION</u></b>
<a href="#">260-13706</a>	Wilwood Residual Pressure Valve (2 lb for disc brakes)
<a href="#">260-13707</a>	Wilwood Residual Pressure Valve (10 lb for drum brakes)
<a href="#">260-8419</a>	Wilwood Proportioning Valve, Knob Style
<a href="#">260-8420</a>	Wilwood Proportioning Valve, Lever Style
<a href="#">260-11179</a>	Wilwood Combination Proportioning Valve with Brake Light Switch
<a href="#">290-0632</a>	Wilwood Racing Brake Fluid (Hi-Temp° 570) (12 oz)
<a href="#">290-6209</a>	Wilwood Racing Brake Fluid (EXP 600 Plus) (16.9 oz)
<a href="#">340-13831</a>	Wilwood Floor Mount Brake Pedal (with balance bar)
<a href="#">340-13832</a>	Wilwood Swing Mount Brake Pedal (with balance bar)
<a href="#">260-6764</a>	Wilwood 3/4 inch High Volume Aluminum Master Cylinder
<a href="#">260-6765</a>	Wilwood 7/8 inch High Volume Aluminum Master Cylinder
<a href="#">260-6766</a>	Wilwood 1 inch High Volume Aluminum Master Cylinder
<a href="#">260-8555</a>	Wilwood 1 inch Aluminum Tandem Chamber Master Cylinder
<a href="#">260-8556</a>	Wilwood 1-1/8 inch Aluminum Tandem Chamber Master Cylinder
<a href="#">220-12862</a>	Stainless Steel Braided Flexline Kit, Universal, 18 Inch, Domestic, M10x1 IF
<a href="#">220-7699</a>	Stainless Steel Braided Flexline Kit, Universal, 16 Inch, Domestic, 3/8-24 IF
<a href="#">220-8307</a>	Stainless Steel Braided Flexline Kit, Universal, 18 Inch, Domestic, 3/8-24 IF
<a href="#">220-11238</a>	Stainless Steel Braided Flexline Kit, Universal, 20 Inch, Domestic, 3/8-24 IF
<a href="#">220-11237</a>	Stainless Steel Braided Flexline Kit, Universal, 22 Inch, Domestic, 3/8-24 IF