



C2614 Installation Instructions 2000-2006 Chevy/GM Tahoe/Yukon/ Suburban/Avalanche 4wd 6" Suspension Lift

Read and understand all instructions and warnings prior to installation of product and operation of vehicle.

Zone Offroad Products recommends this system be installed by a professional technician. In addition to these instructions, professional knowledge of disassembly/ reassembly procedures and post installation checks must be known. Minimum tool requirements include the following: Assorted metric and standard wrenches, hammer, hydraulic floor jack and a set of jack stands. See the "Special Tools Required" section for additional tools needed to complete this installation properly and safely.

» PRODUCT SAFETY WARNING

Certain Zone Suspension Products are intended to improve off-road performance. Modifying your vehicle for off-road use may result in the vehicle handling differently than a factory equipped vehicle. Extreme care must be used to prevent loss of control or vehicle rollover. Failure to drive your modified vehicle safely may result in serious injury or death. Zone Offroad Products does not recommend the combined use of suspension lifts, body lifts, or other lifting devices.

You should never operate your modified vehicle under the influence of alcohol or drugs. Always drive your modified vehicle at reduced speeds to ensure your ability to control your vehicle under all driving conditions. Always wear your seat belt.

» TECHNICAL SUPPORT

www.zoneoffroad.com may have additional information about this product including the latest instructions, videos, photos, etc.

Send an e-mail to tech-zone@sporttruckusainc.com detailing your issue for a quick response.

888.998.ZONE Call to speak directly with Zone tech support.

» PRE-INSTALLATION NOTES

1. Special literature required: OE Service Manual for model/year of vehicle. Refer to manual for proper disassembly/reassembly procedures of OE and related components.
2. Adhere to recommendations when replacement fasteners, retainers and keepers are called out in the OE manual.
3. Larger rim and tire combinations may increase leverage on suspension, steering, and related components. When selecting combinations larger than OE, consider the additional stress you could be inducing on the OE and related components.
4. Post suspension system vehicles may experience drive line vibrations. Angles may require tuning, slider on shaft may require replacement, shafts may need to be lengthened or trued, and U-joints may need to be replaced.
5. Secure and properly block vehicle prior to installation of Zone Offroad Products. Always wear safety glasses when using power tools.
6. If installation is to be performed without a hoist, Zone Offroad Products recommends rear alterations first.
7. Due to payload options and initial ride height variances, the amount of lift is a base figure. Final ride height dimensions may vary in accordance to original vehicle attitude. Always measure the attitude prior to beginning installation.

Difficulty Level

easy 1 2 3 **4** 5 difficult

Estimated installation: 8 hours

Special Tools Required

GM Style Torsion Bar Tool

Welder

Reciprocating Saw or Equivalent

Drill w/ 1/2" Bit

36mm Axle Socket

Tire/Wheel Fitment

33x12.50 w/ 17x9 & 5" BS

35x12.50 w/ 20x9 & 5.75" BS

Kit Contents

Qty Part

ZONC2613 Contents

1	Steering Knuckle (drv)
1	Steering Knuckle (pass)
2	Sway Bar Link
1	621 Bolt Pack
1	567 Bolt Pack
1	568 Bolt Pack
1	569 Bolt Pack
1	570 Bolt Pack
1	574 Bolt Pack
1	575 Bolt Pack
1	.750 x .090 x 2.950 Sleeve
2	Offset Sway Bar Bracket - black
2	Hourglass Bushing - black
4	.750 x .090 x 1.575 Sleeve
4	Small Stem Bushing - black
1	GM Tahoe Weld Plate
1	Loctite - 1ml (11094-00764)
6	11.5in Nylon Cable Tie - Black
4	Grade 9 USS F/W 7/16 YZ Stem Washer
2	Bump Stop Bushing
2	Jeep YJ Bushing- Black

ZONC2614 Contents

1	06 GM Front Crossmember - black
2	Compression Tube - black
2	99 GM CV Spacer
2	Torsion Bar Drop Bracket - black
1	99/06 Chevy Xmbr Zone
1	99-06 GM Diff Drop - black
1	99-06 GM Diff Drop - PS - black
2	.750 x .095 x 1.520 DOM Sleeve
1	579 Bolt Pack
1	.375 x 1.25 x 1.00 Mech Tube
4	Bushing - (97 Duro) - black

ZONC2615 Contents

1	GM Skid Plate -Revision C
2	GM Tah/Yuk 6in
2	Sway Bar End Link
2	GM Tahoe Bump Stop Extension - black
1	Track Bar Bracket - black
2	1/4" Track Bar Bracket Spacer
1	550 Bolt Pack
1	551 Bolt Pack
8	1 .875 x .134 x 1.67 DOM Sleeve
1	.750 x .120 x 3.0 Jeep YJ Sleeve
4	.625 x .060 x 1.475 Sleeve
4	5/8 ID Hourglass Bushing - black
3	11.5in Nylon Cable Tie - Black

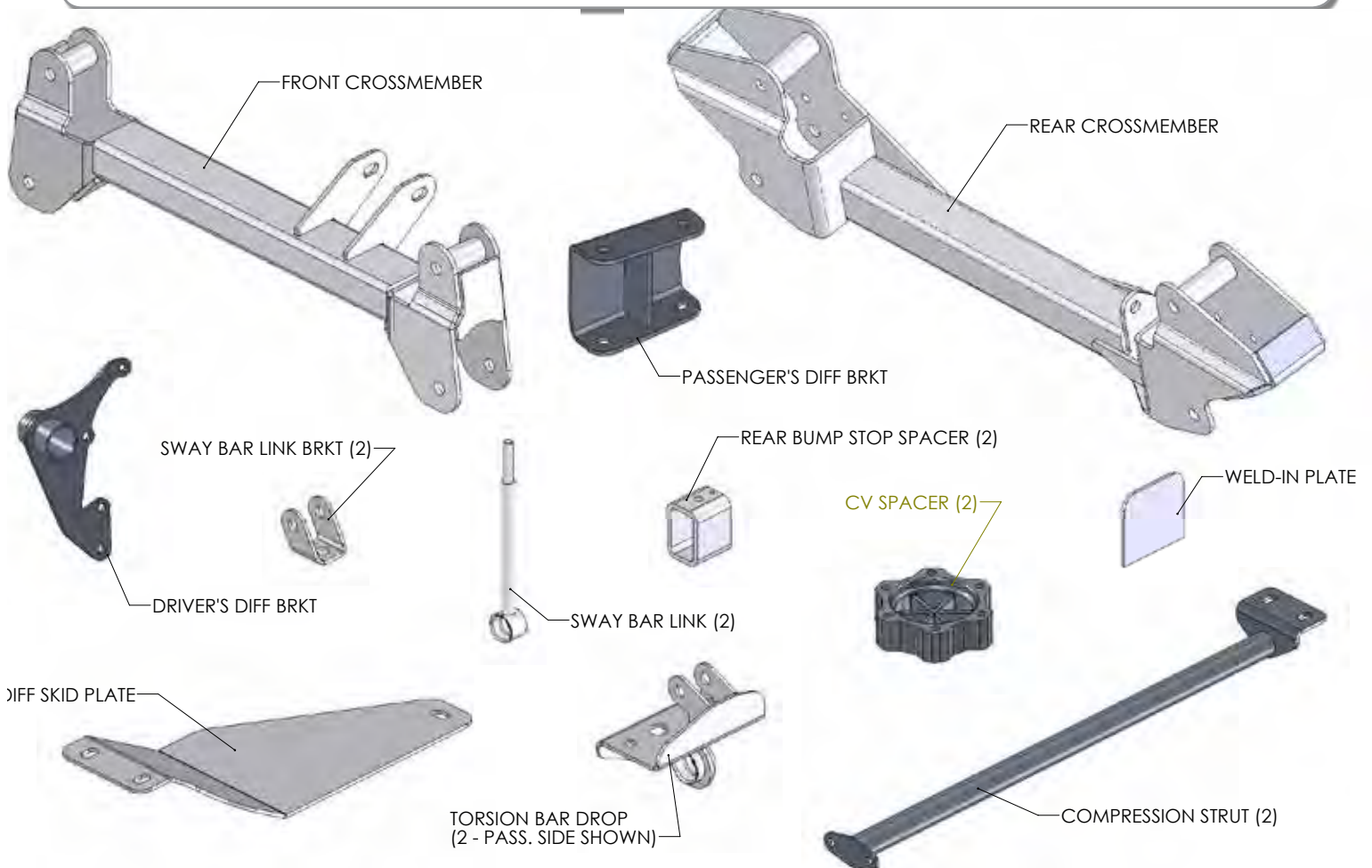

INSTALLATION INSTRUCTIONS

1. Park the vehicle on a flat, clean surface and block the rear wheels for safety.
2. Disconnect the positive and negative battery cables.

» FRONT INSTALLATION

3. Raise the front of the vehicle and support with jack stands under the frame rails.
4. Remove the wheels.
5. Measure and record the length of the exposed thread on the torsion bar adjuster bolts **Figure 1**. Record the lengths here for use later during the installation

DRV Side: _____ PASS Side: _____



Figure 1

6. Unload the torsion bars but do not remove. Save adjuster bolt/retainer block.
7. Mark the unloaded torsion bars to indicate DRV side and PASS side. Also mark the bars to indicate front versus rear.
8. Remove the torsion bar adjuster plate by pushing the torsion bar forward to allow the plate to drop free. On most vehicles this will require using a hammer/punch or air hammer. Access the end of the torsion bar through the hole in the back of the torsion bar crossmember and drive forward. Leave the torsion bars in the lower control arms.
9. Remove the two bolts that attach the torsion bar crossmember to the frame rails **Figure 2**. Remove the torsion bar crossmember from the vehicle. Save bolts and crossmember.

Important—measure before starting!

Measure from the center of the wheel up to the bottom edge of the wheel opening

LF _____ RF _____

LR _____ RR _____

Step 6 Note

Unloading torsion bars: Torsion bars are under pressure even with the front suspension off the ground. A proper torsion bar tool is necessary to unload and remove the torsion bars from the vehicle. A tool designed specifically for GM torsion bars (#J36202 or equivalent) is required. This tool can be purchased from several sources and most part stores will lend these tools for little or no charge. Follow the individual tool instructions for proper use.



Figure 2

10. Remove the torsion bars by pulling them rearward out of the lower control arms. Set the torsion bars aside.
11. If equipped, remove the four bolts mounting the factory belly pan to the frame **Figure 3**. This will not be reused.



Figure 3

12. Disconnect the sway bar end links from the sway bar and the lower control arms **Figure 4**. Discard the link assemblies.
13. Disconnect the tie rod ends from the steering knuckles. Remove the tie rod end nuts and save. Strike the knuckle near the tie rod end to dislodge the tie rod end taper **Figure 4**. Remove the tie rod ends from the knuckles.
14. Disconnect the ABS brake wire from the connector at the top of the frame **Figure 5**. Remove the wire from the plastic retainers on the frame and upper control arm **Figure 6**.
15. Disconnect the rubber brake line brackets from the upper control arm and the steering knuckle **Figure 6**. Save hardware.



Figure 4



Figure 5



Figure 6

16. Remove the two bolts mounting the brake caliper assembly to the steering knuckle and hang the caliper out of the way **Figure 7**. Do not hang the caliper by the brake hose. Save mounting bolts.



Figure 7

17. If equipped, remove the rotor retaining clips from the wheels studs. These will not be reused. Remove the brake rotor and set aside.
18. Carefully remove the hub dust cover.
19. Remove the CV axle nut and washer **Figure 8**. Save hardware.

Step 18 Note

A fine-tipped chisel and hammer work well to remove the hub dust cap. Work the chisel around the cap to separate it from the hub.



Figure 8

20. Remove the CV axle flange bolts at the differential **Figure 9**. There are 6 bolts per side. Discard the bolts.



Figure 9

21. Remove the upper ball joint nut. Thread the nut back on by hand one or two turns. Strike the knuckle near the upper ball joint to release the taper. Remove the upper ball joint nut (save) and remove the ball joint from the knuckle. Allow the knuckle to swing out and remove the CV axle from the hub **Figure 10**. Mark the CV axle to indicate DRV side and PASS side.



Figure 10

22. Remove the lower ball joint nut and thread back on by hand one or two turns. Strike the knuckle near the ball joint to release the taper. Remove the ball joint nut and remove the knuckle from the lower control arm. Save the lower ball joint nut and set the knuckle/hub assembly aside.
23. Disconnect the shocks from the frame and lower control arm. Remove shocks, save lower mounting hardware and discard the rest.
24. Remove the front and rear lower control arm bolts and remove the control arms from the vehicle **Figure 11**. Save the control arms and mounting hardware.



Figure 11

25. Remove the factory bump stops from the frame **Figure 12**. A pair of channel locks work well for this.



Figure 12

26. Make an alignment mark on the front driveshaft and front differential input yoke. Remove the four bolts/clamps from the yoke and remove the front driveshaft from the differential **Figure 13**. Save the driveshaft hardware.



Figure 13

27. Remove the four bolts mounting the rear crossmember to the rear lower control arm pockets **Figure 14**. Remove the crossmember from the vehicle. The crossmember and hardware will not be reused.



Figure 14

28. Disconnect the electrical connector from the front differential actuator. **Figure 15**. Remove the wire from the three plastic wire retainers along the top of the differential.
29. Disconnect the axle breather tube from the driver's side of the differential.
30. Loosen but do not remove all of the front differential mounting bolts. There are two on the passenger's side, one on the upper front driver's side and one on the lower rear driver's side.
31. Locate the remaining wing of the rear crossmember on the lower rear driver's side control arm pocket. This portion of the frame must be removed to clear the front differential in its new, lower position. A precise measurement and cut is outlined later in the instructions but to make removing the differential easier the wing portion can be cut off now. Using a reciprocating saw (recommended), hack saw or cut-off wheel, remove the wing just inside of the control arm pocket **Figure 15**. Take care not to cut into the differential housing or bolt.

Step 31 Note

Do not use any type of flame-cutting to cut on the frame. The vehicle undercoating is flammable.



Figure 15

32. Support the front differential with an appropriate jack. Remove the differential mounting hardware and lower the differential from the vehicle and set aside. Save hardware.

Step 33 Note

Measure twice, cut once!

33. The lower rear driver's side control arm pocket must be trimmed to provide clearance for the front differential. Measure inward from the lower control arm mounting hole 1-3/4" and mark on both the front and back surfaces of the pocket **Figure 16**. Make vertical cut lines at the marks and connect the cut lines along the top surface of the pocket.

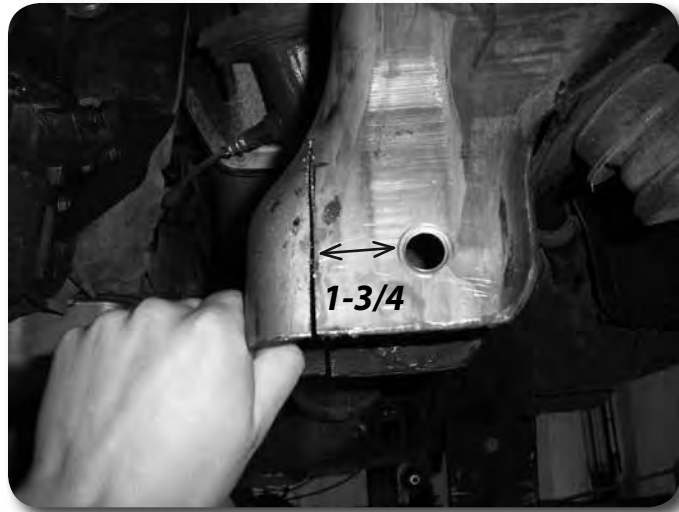

Figure 16

34. Using a reciprocating saw (recommended), hack saw or cut-off wheel, cut the pocket along cut lines.
35. With the control arm pocket trimmed, be sure the area around the cut is free from grease, oil and undercoating. Locate the provided weld-in support plate and place it up to the frame where the cut was made. The chamfered corners of the plate go to the top. Align the bottom of the plate to the bottom edge of the control arm pocket and center the plate horizontally in the pocket. Tack weld the plate in place.
36. With the support plate tack in place, double check the location and then finish welding it in place **Figure 17**. Allow the area to cool slowly and then paint any exposed metal to prevent rust.

Step 35 Note

It is important to completely remove the undercoating around the area to be welded. This will avoid weld contamination, as well as the undercoating igniting/melting.



Figure 17

37. The front upper mount bushing of the differential must be removed to provide adequate steering clearance. Mark a cut line around the mount that is flush with the top of the differential housing. Using a reciprocating saw (recommended) or hack saw, cut the mount off of the differential **Figure 18**. Take extra care not to cut into the differential housing.



Figure 18

38. Install the provided large bushings (2) and 0.750" OD x 2.955" long sleeve into the eye of the new driver's side differential bracket.
39. Install the bushings and sleeve in the C-shaped differential housing bracket. Set the differential housing bracket up to the housing in the appropriate location and remove the four housing bolts that correspond to the holes in the bracket (Figure 19). Using three 10mm x 60mm bolts and washers, attach the bracket to the differential housing in the tapped factory holes. Attach the remaining location with 10mm x 70mm bolt with washers, spacer sleeve, and locknut. Torque the bolts to 30 ft-lbs. Use Loctite® on mounting bolts that thread into the housing. Note: While working with the differential housing it is normal for some fluid leakage to occur. Check and fill as necessary when installation is complete.

Step 39 Note

Differential bolts/washers are located in hardware pack #567

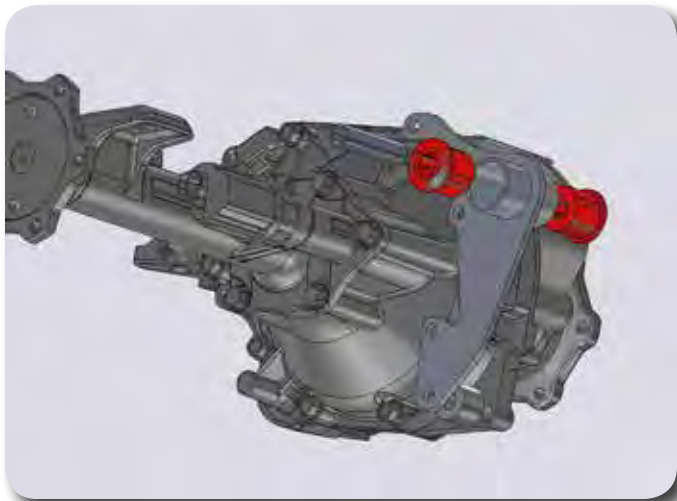

Figure. 19

40. Locate the new passenger's side differential bracket. Install the bracket on the existing studs on the passenger's side factory bracket. Fasten with the original nuts and washers. When installed the open side of the bracket will face inward and the bracket will taper down as it goes to the rear Figure 20. Torque nuts to 65 ft-lbs.

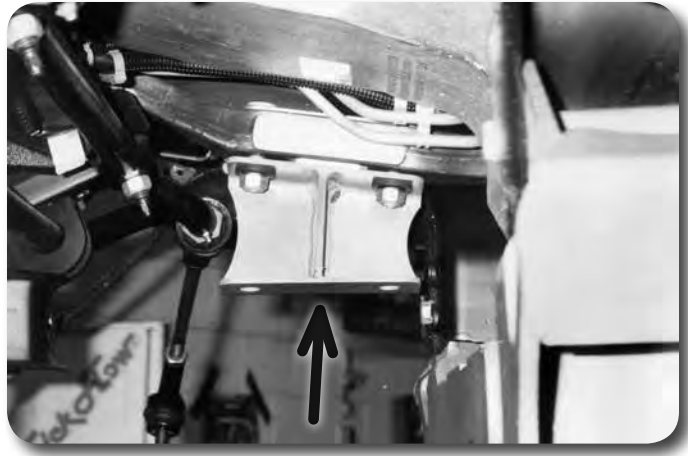

Figure 20

41. Inspect the inside factory control arm mounting holes. There will be a sharp lip left from the original control arm/hardware. Use a file or rotary grinder to remove the sharp lip left from the control arms **Figure 21**. This will allow the new cross members to be installed easily.



Figure 21

42. Locate the new front crossmember. Install the crossmember in the front lower control arm pockets so that the two longer differential mounting tabs are on the driver's side pointing rearward **Figure 22**. Fasten the crossmember with the original lower control arm hardware. Run the bolts from front to rear. Leave hardware loose.



Figure 22

- Using an appropriate jack, raise the differential up into the vehicle. Align the new driver's side differential bracket in the front crossmember mounting tabs. Align the passenger's side mounting holes to the new bracket **Figure 23**. Fasten the driver's side mount with a 9/16" x 4-1/2" bolt, nut and 9/16" SAE washers. Fasten the passenger's side with 9/16" x 1-3/4" bolts, nuts and 9/16" SAE washers. Leave the driver's side bolt loose. Tighten the passenger's side bolts just enough to make the two mounting surfaces set flush.

Step 43 Note

Differential bolts/washers are located in hardware pack #567

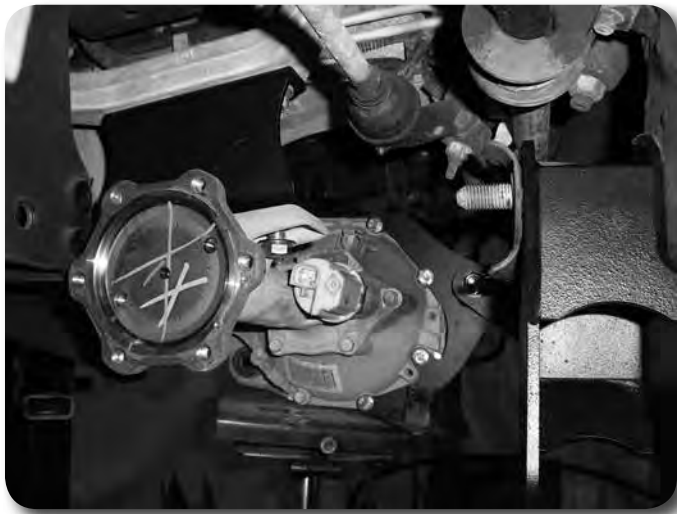

Figure 23

- Install the provided new bump stops on the wings on the new rear crossmember **Figure 24**. Fasten the bump stops with 3/8" nuts, flat washers and lock washers. Tighten hardware securely.

Step 44 Note

Bump stop nuts/washers are located in hardware pack #570



Figure 24

45. Install the rear crossmember in the rear lower control arm pockets so that the differential mount lines up with the differential **Figure 25**. Fasten the crossmember with the original lower control arm hardware. Run the bolts from front to rear. Leave hardware loose.

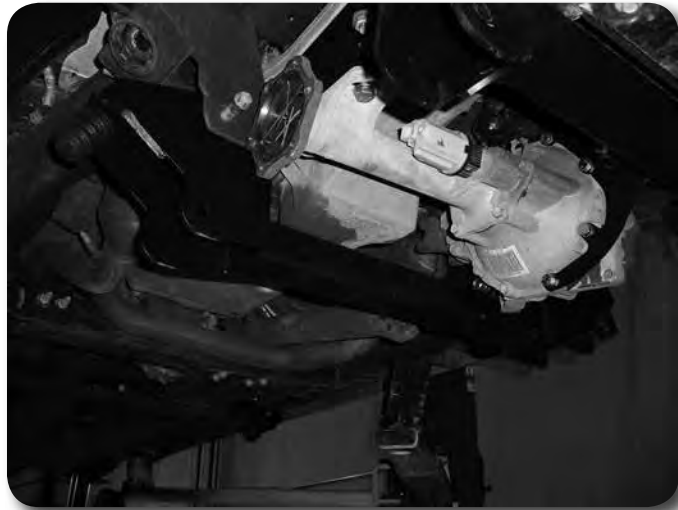

Figure 25

Step 46 Note

Differential bolts/washers are located in hardware pack #567

Step 47 Note

Lower control arm bolts/nuts/washers are located in hardware pack #621.

46. Fasten the differential to the new mount in the rear crossmember with a 9/16" x 4" bolt, nut and 9/16" SAE washers. Run the bolt from the outside in.
47. Install the factory lower control arms into the new crossmembers. Fasten the control arms with 5/8" x 4-1/2" bolts (front), 5/8" x 5-1/2" bolts (rear), nuts and 5/8" SAE washers **Figure 26**. Run the bolts from the front to rear. Leave hardware loose.



Figure 26

48. Go back and torque the four new differential bolts to 90 ft-lbs. Torque the factory control arm pocket bolts to 125 ft-lbs. DO NOT tighten the new control arm bolts at this time. This will be done at the end of the installation.
49. Locate the new differential skid plate. Position the skid plate so that it aligns with the two tapped holes in the bottom of the front crossmember and the hole with the welded nut on the bottom driver's side of the rear crossmember **Figure 27**. Fasten the skid plate with 1/2" x 1-1/4" button head bolts and 1/2" SAE washers. Use Loctite on the bolt threads and torque to 55 ft-lbs.

Step 49 Note

Skid Plate bolts/washers are located in hardware pack #567

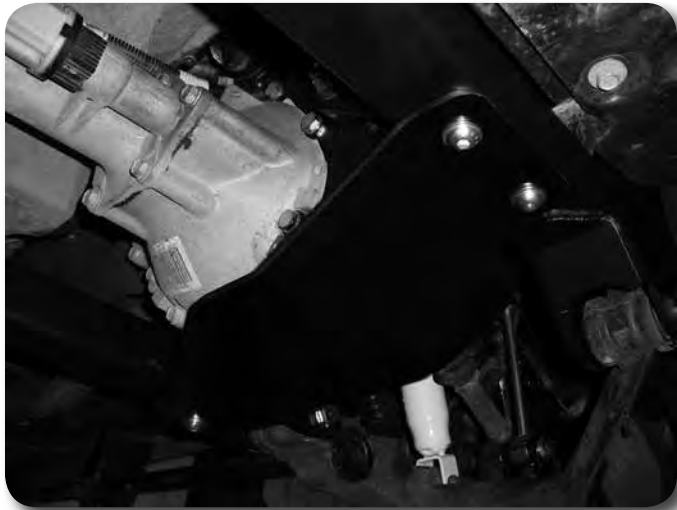

Figure 27

50. Locate the new compression strut tubes. Loosely attach the tubes to the corresponding holes located on the back of the rear crossmember, just above the control arm bolt. Position the tube so that the rear mount sets flat to the transmission crossmember. Fasten the compression strut to the rear crossmember with 3/8" x 1-1/4" bolts, nuts and 3/8" SAE washers. Leave hardware loose.

Step 50 Note

All compression strut bolts/nuts/washers are located in hardware pack #575



Figure 28

51. Position the back end of the compression strut up to the transmission crossmember. The outer hole in the compression strut end will match up with an existing hole in the transmission crossmember frame bracket. Attach the compression strut to the frame bracket with 3/8" x 1-1/4" bolt, nut and 3/8" SAE washers **Figure 29**. With the compression strut held in place locate the center of the inside hole in the compression bracket and drill a 5/16" hole. Install a 3/8" x 1-1/4" self-tapping bolt in the new hole. Leave hardware loose.



Figure 29

52. With all of the compression strut hardware installed, torque all of the 3/8" hardware to 30 ft-lbs starting with the front hardware first.
53. Locate the new steering knuckles and identify the driver's and passenger's side. Install the appropriate knuckle on the lower control arm and fasten with the original lower ball joint nut. Swing the knuckle up and attach to the upper ball joint with the original nut. Torque the upper ball joint nut to 37 ft-lbs and the lower ball joint nut to 74 ft-lbs **Figure 30**.



Figure 30

54. Remove the hub bearing and brake dust shield from the factory steering knuckles **Figure 31**. Be sure to note which hub goes on which side of the vehicle. Save mounting bolts.

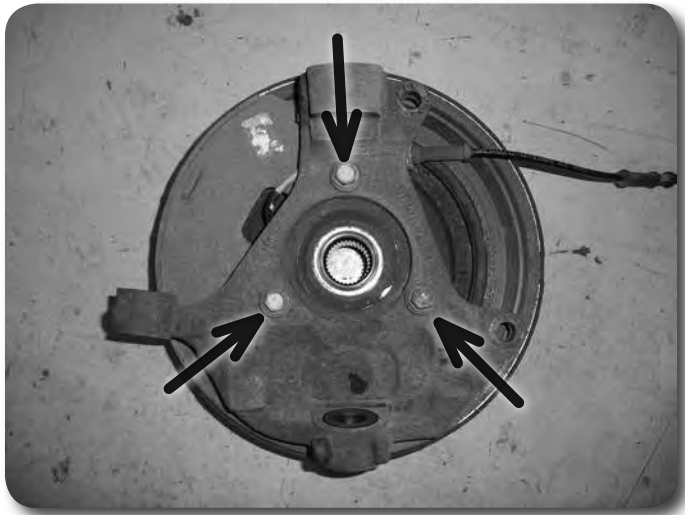

Figure 31

55. The brake dust shield needs to be trimmed. Measure in from the lower vertical edge (opposite the ABS sensor location) $\frac{3}{4}$ " and make a vertical cut line along the entire flat section **Figure 32**. Cut the mark section off of the brake dust shield.

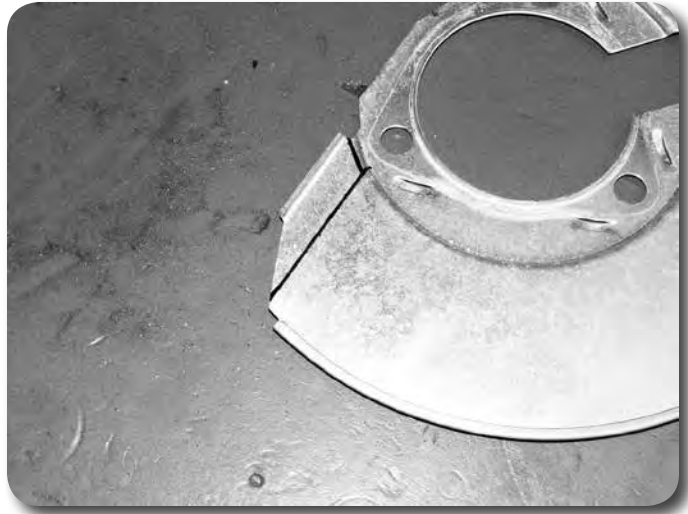

Figure 32

56. Install the modified dust shield back on the hub assembly, making certain the ABS line is run through the correct hole in the shield. Install the hub/dust shield on the appropriate new knuckle so that the ABS line runs up toward the steering arm. Fasten the hub/shield with the OE bolts **Figure 33**. Apply Loctite to the bolt threads and torque to 133 ft-lbs.

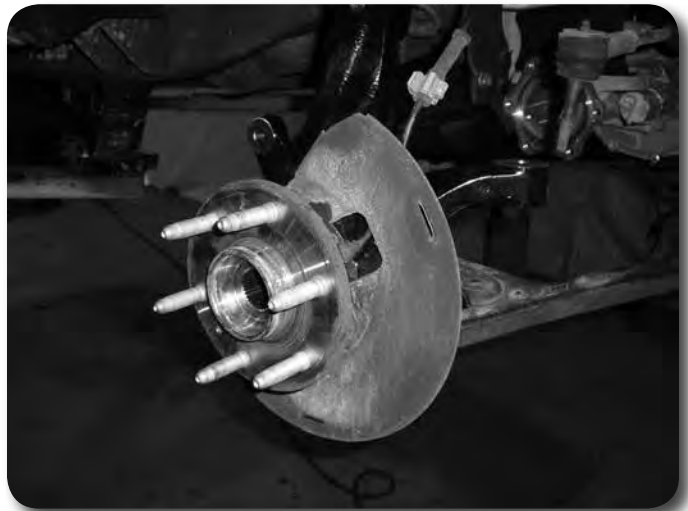

Figure 33

57. Install the brake rotor on the hub. Install the brake calipers on the knuckles with the original bolts. Apply Loctite to the bolt threads and torque the bolts to 125 ft-lbs. Be sure the brake hose is running under the upper control arm and behind the steering knuckle.
58. Install the appropriate CV axle shaft through the hub **Figure 34**. Install the original CV axle nut and washer and torque to 155 ft-lbs. Reinstall the hub dust cap.



Figure 34

59. Position the provided CV spacer between the CV shaft and the differential mounting flange **Figure 35** Fasten the CV and spacer to the differential flange with 10mm x 70mm bolts and 10mm washers. Use Loctite on the bolt threads and torque to 45 ft-lbs using a crossing pattern.

Step 59 Note

CV Spacer bolts/washers are located in hardware pack #568



Figure 35

60. Reconnect the brake hose bracket to the upper control arms with the original bolt. Torque to 10 ft-lbs. Attach the second brake hose bracket to the back side of the steering knuckle with a provided 1/4" x 3/4" self-tapping bolt **Figure 36**. Torque to 10 ft-lbs.

Step 60 Note

The factory brake hoses can be adjusted in the factory brackets by lubing the hoses with silicone spray near and in the bracket. Brake hose hardware is located in hardware pack #570.



Figure 36

61. Route the ABS line from around the back side of the knuckle and up to the plastic retainer clip on the upper control arm. From there run the ABS line up to the frame and reconnect to the connector and plastic retaining clip.
62. Reattach the front drive shaft to the differential with the original clamps/bolts. Torque bolts to 19 ft-lbs.
63. Reconnect the differential actuator wire to the actuator and fasten the wire to the differential in the original plastic clips.
64. Pull the necessary slack down for the differential breather hose to reconnect to the breather on the driver's side of the differential.
65. Install the provided offset sway bar link u-bracket on the lower control arm in the original sway bar link hole with a 5/8" x 1-3/4" bolt, nut and washers **Figure 37**. Position the bracket so that it offsets in toward the center of the vehicle. In some cases it may be necessary to slightly clearance to hole for the 5/8" hardware.

Step 65 Note

All sway bar link bolts/nuts/washers are located in hardware pack #569



Figure 37

66. Locate the new front sway bar links, small hourglass bushings and (2) 0.750" OD x 1.575" long sleeves. Install the bushings and sleeves into the eyes of the links. Install the links into the new brackets on the lower control arms with 9/16" x 2-3/4" bolts, nuts and washers **Figure 38**. Run the bolts from front to rear and leave hardware loose.



Figure 38

67. Install a provided stem washer followed by a stem bushing on each sway bar link. Install both links into the sway bar and install a second stem bushing followed by a second washer. Fasten the sway bar link upper assemblies with 3/8" nylock nuts **Figure 39**. Leave nuts loose.



Figure 39

68. Attach the tie rod ends to the knuckles. Fasten with the original nuts and torque to 37 ft-lbs.
69. Install the new shocks with the factory lower hardware and the new provided bushings/washers/nuts. Tighten the upper hardware until the bushings begin to swell. Torque the lower bolt to 60 ft-lbs.
70. Install the torsion bars into the lower control arms and slide forward about 6". Be sure they are installed in the proper location and orientation.
71. Place the torsion bar bracket up to the original mount and bottom of frame rail. Mark the center of the holes on the bottom side of the frame and drill to 5/16"-21/64".



Figure 40

Step 72, 73 Note

Torsion bar brackets are driver's and passenger's side specific. 9/16" hardware for torsion bar brackets is located in hardware pack #574.

Step 74 Note

3/8" self tapping torsion bar bracket hardware is located in hardware pack #579

72. Locate the provided torsion bar drop brackets, bushings and (2) 0.750" OD x 1.575" long sleeves. Install the bushings and sleeves in the brackets.
73. Install the new torsion bar bracket on the frame by attaching the upper tabs to the original mount on the frame. Fasten with the provided 9/16" x 3" bolt, nut and 9/16" SAE washers. Leave hardware loose.
74. Fasten the bracket to the bottom of the frame through the 5/16" drilled hole with the provided 3/8" x 1-1/4" self tapping bolts. Leave hardware loose.
75. Attach the factory torsion bar crossmember to the new drop brackets and fasten with the original bolts. Leave hardware loose. Be sure the large torsion bar holes in the crossmember are toward the front.
76. Go back and tighten the torsion bar drop bracket hardware, starting with the 3/8" (30 ft-lbs) followed by the 9/16" (95 ft-lbs). With the bracket hardware tight, torque the original crossmember hardware to 90 ft-lbs.
77. Locate the original torsion bar adjuster plates. Slide the torsion bars back into the torsion bar crossmember and into the adjuster plates. The plates should fit on the torsion bars so that they are positioned roughly horizontal in the vehicle.
78. Load the torsion bars with the appropriate tool. Reinstall the adjuster bolt/retaining plate assembly. Reset the torsion bar adjuster bolt position to the original height measurement taken at the beginning of the installation.
79. Install the front wheels. Torque the lug nuts to 140 ft-lbs. Lower the vehicle to the ground.
80. Bounce the front end to settle the suspension.
81. Tighten the upper sway bar link stem nuts until the bushings begin to swell. Torque the lower sway bar link bolt to 90 ft-lbs.
82. Torque the lower control arm bolts (4) to 125 ft-lbs.
83. Check all front hardware for proper torque.
84. Check all brake lines for proper clearances. Adjust as necessary.
85. Check tire/wheel clearance with the fenders/bumper as well as with the steering knuckle. It is not uncommon to trim the lower plastic valance of the bumper slightly to add proper tire clearance while turning.

» REAR INSTALLATION

1. Block the front wheels for safety.
2. Disconnect the track bar from the rear axle mount. Retain mounting hardware.
3. Raise the rear of the vehicle and support with jack stands under the frame rails just ahead of the lower control arm mounts.
4. Support the axle with a hydraulic jack.
5. Remove the wheels.
6. Remove the OE shocks and sway bar links. Retain all mounting hardware.
7. Disconnect the brake line junction block from the bracket mounted to the differential. **Figure 41**

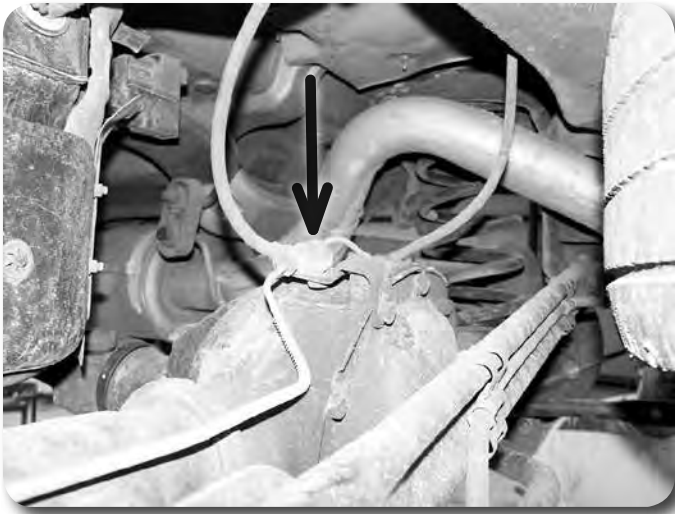

Figure 41

8. Disconnect the parking brake cable loop from the driver's side axle lower control arm mount. **Figure 42**



Figure 42

9. Disconnect the parking brake cable loop from the passenger's side frame rail. Remove the loop from the cable. **Figure 43**

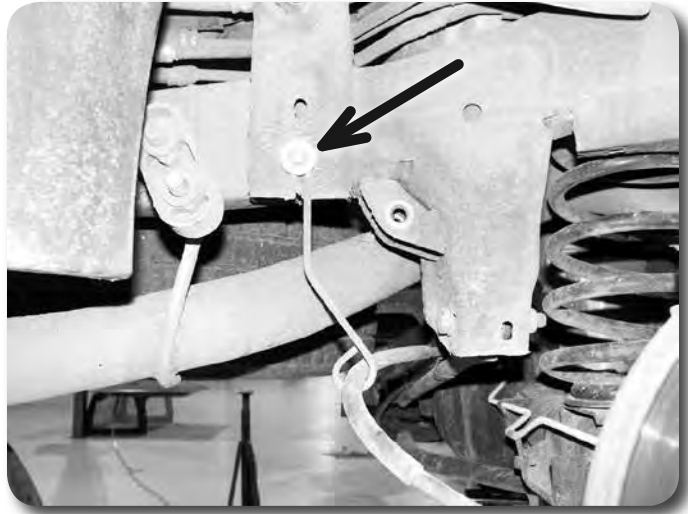

Figure 43

10. Remove the parking bracket cable from the retaining clips holding it to the rear track bar. **Figure 43.**
11. Loosen but do not remove the four (two per arm) lower control arm pivot bolts.
12. Lower the rear axle until the springs can be pulled free. Remove the springs. Retain the top and bottom rubber isolators.
13. Ensure that the axle is well supported and remove the lower control arm-to-axle pivot bolts and swing the lower control arms down away from the axle.
14. Mark and cut the small tab protruding out on the top front end of the lower control arm mounts so that a single straight edge is left. **Figure 44**

Step 12 Note

Take care not to over-extend the brake lines.

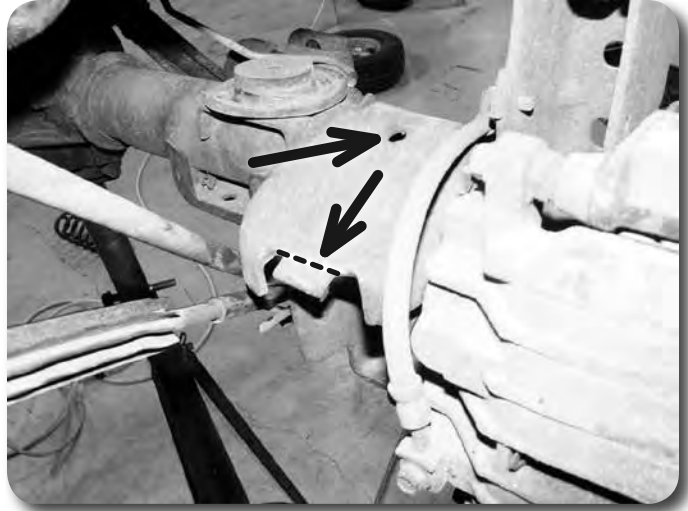

Figure 44

15. Loosely mount the provided bump stop brackets on the top of the lower control arm axle mount using the existing hole **Figure 44** and 7/16" hardware. **Figure 45**

Step 15 Note

The 7/16" hardware is located in bolt pack #551. The longer end of the mounting plate will go to the front of the vehicle



Figure 45

16. With the bump stop brackets in position, using the bracket as a template, mark the other mounting hole to be drilled in the axle mount.
17. Rotate the brackets out of the way and drill 7/16" holes at the marks. Attach the brackets with the remaining 7/16" hardware and torque all four mounting bolts to 50 ft-lbs.
18. Install the new coil spring in conjunction with the OE upper and lower rubber isolators.
19. Raise the axle to engage the springs enough to allow for the lower control arms to be reattached. Reattach the lower control arms with the OE hardware. Leave hardware loose.
20. Loosely install the provided track bar relocation bracket to the axle with a 9/16" x 3-1/2" bolt, nut and 9/16" SAE washers through the original track bar mounting hole. **Figure 46**

Step 18 Note

Take care not to over-extend the brake lines.

Step 20 Note

Hardware located in bolt pack 550.

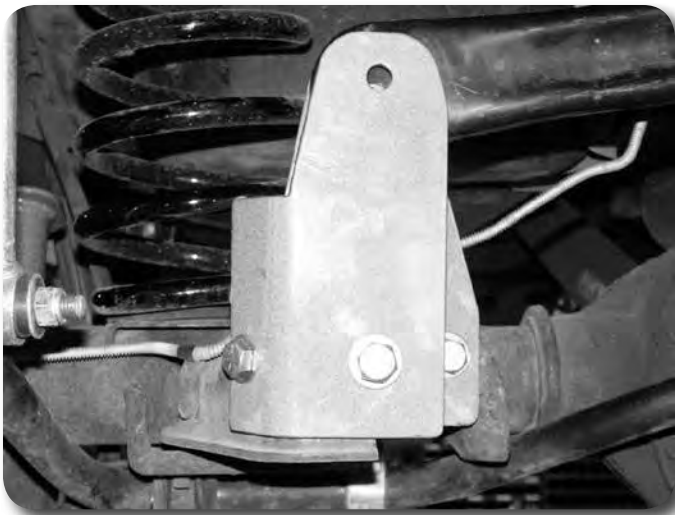

Figure 46

21. Ensure that the track bar bracket is square to the bottom of the OE bracket and mark the remaining two holes in the bracket to be drilled. There are two holes on the driver side of the bracket, mark the hole in the bracket that best matches the axle bracket to be drilled. Remove the bracket and drill a 1/2" hole at the two marks, one on the driver side and one on the passenger side.
22. Reinstall the track bar bracket with the 9/16" hardware in conjunction with the provided 7/8" spacer sleeve **Figure 47**. Leave loose.

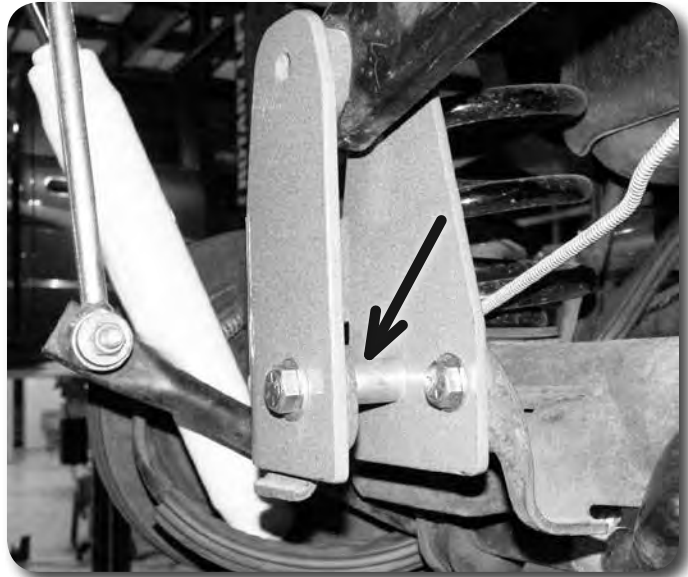

Figure 47A

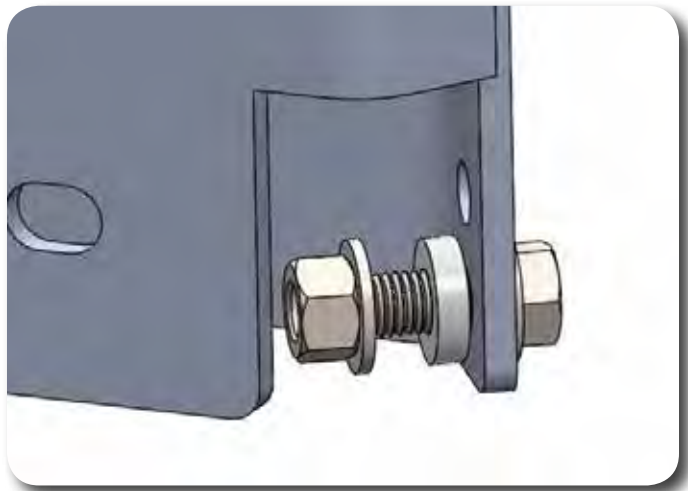

Figure 47B

Step 25 Note

12mm hardware located in bolt pack 551.

23. Attach the bracket through the two drilled holes with $\frac{1}{2}$ " x 1-1/2" bolts, nuts and $\frac{1}{2}$ " SAE flat washers. Leave loose. On the driver side, use a $\frac{1}{4}$ " spacer (01499) between the track bar bracket and the OE bracket as shown in Figure 47B. Leave loose.
24. Tighten the track bar bracket hardware starting with the $\frac{9}{16}$ " (95 ft-lbs) and then the $\frac{1}{2}$ " (65 ft-lbs). The track bar will be reinstalled later with the weight of the vehicle on the axle.
25. Install the provided hourglass bushings and sleeves ($\frac{5}{8}$ " O.D. x 1.5") in the new extended sway bar links. Install the links with the OE upper hardware and the provided 12mm x 70mm bolts, nuts and $\frac{7}{16}$ " USS flat washers at the sway bar. **Figure 48** Torque hardware to 60 ft-lbs.

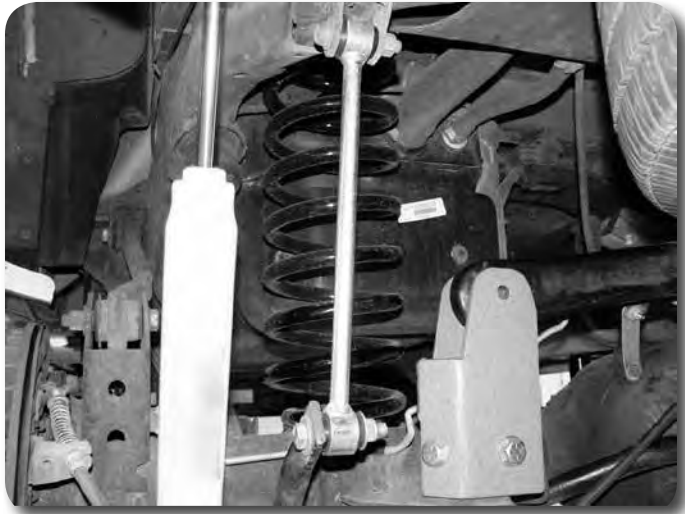

Figure 48

26. Install the new shocks with the OE hardware. Use two provided large shim washers at each shock mount. Torque to 90 ft-lbs.
27. Install the provided brake line spacer sleeve (1.5" long x 3/4" O.D.) between the brake line junction block and the differential mounting tab and fasten with the provided 8mm x 100mm bolt and 5/16" washer **Figure 49**. Torque to 15 ft-lbs.



Figure 49

28. Reattach the parking brake cable to the driver's side axle mount with the original hardware.
29. Remove the brake line bracket mounting bolt at the differential. **Figure 50** Attach the parking brake cable to the differential using the bracket mounting bolt through the provided cable clamp. Torque to 20 ft-lbs.

Step 27 Note

8mm hardware located in bolt pack 551.

Step 29 Note

Ensure that the cable is routed so that it does not rub on any suspension components. Use the provided plastic wire ties where necessary.

Post-Installation Warnings

1. Check all fasteners for proper torque. Check to ensure for adequate clearance between all rotating, mobile, fixed, and heated members. Verify clearance between exhaust and brake lines, fuel lines, fuel tank, floor boards and wiring harness. Check steering gear for clearance. Test and inspect brake system.
2. Perform steering sweep to ensure front brake hoses have adequate slack and do not contact any rotating, mobile or heated members. Inspect rear brake hoses at full extension for adequate slack. Failure to perform hose check/ replacement may result in component failure.
3. Perform head light check and adjustment.
4. Re-torque all fasteners after 500 miles. Always inspect fasteners and components during routine servicing.

Recommend Alignment Specifications

CASTER (DRV/PASS)

$3.60^{\circ} \pm 1.00^{\circ} / 4.30^{\circ} \pm 1.00^{\circ}$

CAMBER

$+0.25^{\circ} \pm 0.60^{\circ}$

TOE

$+0.10^{\circ} \pm 0.20^{\circ}$



Figure 50

30. Install wheels and lower vehicle to ground. Bounce the vehicle to settle the suspension.
31. Torque the lower control arm mounting bolts to 95 ft-lbs.
32. Install the track bar in the track bar relocation bracket with the OE hardware. Torque to 90 ft-lbs.

» POST-INSTALLATION

33. Check all hardware for proper torque.
34. Reconnect the positive and negative battery cables.
35. The vehicle will need a complete front end alignment.
36. Check all hardware after 500 miles.
37. Adjust headlights.