



C2672 Instructions 2019-2023 Chevy / GMC 1/2 Ton 4WD Pickups (Including Denali, Trail Boss & ZR2, AT4 & AT4X, Diesels) 6" Suspension Systems Regular & Denali 4" Suspension System TB, ZR2, AT4, & AT4X

»» READ AND UNDERSTAND ALL INSTRUCTIONS AND WARNINGS PRIOR TO INSTALLATION OF PRODUCT AND OPERATION OF VEHICLE.

Zone Offroad Products recommends this system be installed by a professional technician. In addition to these instructions, professional knowledge of disassembly/ reassembly procedures and post installation checks must be known. Minimum tool requirements include the following: Assorted metric and standard wrenches, hammer, hydraulic floor jack and a set of jack stands. See the "Special Tools Required" section for additional tools needed to complete this installation properly and safely.

»» PRODUCT SAFETY WARNING

Certain Zone Suspension Products are intended to improve off-road performance. Modifying your vehicle for off-road use may result in the vehicle handling differently than a factory equipped vehicle. Extreme care must be used to prevent loss of control or vehicle rollover. Failure to drive your modified vehicle safely may result in serious injury or death. Zone Offroad Products does not recommend the combined use of suspension lifts, body lifts, or other lifting devices.

You should never operate your modified vehicle under the influence of alcohol or drugs. Always drive your modified vehicle at reduced speeds to ensure your ability to control your vehicle under all driving conditions. Always wear your seat belt.

»» TECHNICAL SUPPORT

www.zoneoffroad.com may have additional information about this product including the latest instructions, videos, photos, etc.

Send an e-mail to tech-zone@ridefox.com detailing your issue for a quick response.

888.998.ZONE Call to speak directly with Zone tech support.

»» PRE-INSTALLATION NOTES

1. Special literature required: OE Service Manual for model/year of vehicle. Refer to manual for proper disassembly/reassembly procedures of OE and related components.
2. Adhere to recommendations when replacement fasteners, retainers and keepers are called out in the OE manual.
3. Larger rim and tire combinations may increase leverage on suspension, steering, and related components. When selecting combinations larger than OE, consider the additional stress you could be inducing on the OE and related components.
4. Post suspension system vehicles may experience drive line vibrations. Angles may require tuning, slider on shaft may require replacement, shafts may need to be lengthened or trued, and U-joints may need to be replaced.
5. Secure and properly block vehicle prior to installation of Zone Offroad Products. Always wear safety glasses when using power tools.
6. If installation is to be performed without a hoist, Zone Offroad Products recommends rear alterations first.
7. Due to payload options and initial ride height variances, the amount of lift is a base figure. Final ride height dimensions may vary in accordance to original vehicle attitude. Always measure the attitude prior to beginning installation.

Difficulty Level

easy 1 2 3 **4** 5 difficult

Estimated installation: 7-9 hours

Special Tools Required

Welder

Reciprocating Saw

Grinder/Sanding Disc

36mm Axle Socket

Tire/Wheel Fitment

*See Install Notes

rev031423

***Important* Verify you have all of the kit components before beginning installation.**

Kit Contents

Box ZONC2670- DRV Steering Knuckle

Box ZONC2671- PASS Steering Knuckle

Qty	Part
1	DRV Steering Knuckle
1	PASS Steering Knuckle
2	Ball Joint Caps
2	O-Rings
2	Steering Stop
1	DRV Upper Control Arm
1	PASS Upper Control Arm
2	Outer Tie Rods
1	Bolt Pack 640
4	14mm-2.00 x 80mm Bolt
4	14mm-2.0 Nut
8	14mm Washer
1	Bolt Pack 874
3	Wire Clamp
2	1/4"-20 x 3/4" Bolt
2	1/4"-20 Nut
4	1/4" SAE Washer
2	12mm-1.75 Nylock Nut

Box Kit ZONC2662 Front Box Kit

Qty	Part
1	Front Crossmember
1	Rear Crossmember
1	Sway Bar Drop - DRV
1	Sway Bar Drop - PASS
1	Differential Drop Bracket - Drv
1	Differential Drop Bracket - Pass
1	Differential Drop Bracket - PASS Brace
1	Transmission Line Drop Bracket (Diesel Models Only)
1	Bolt Pack 585
2	18mm-2.50 x 120mm bolt class 10.9 yellow zinc
2	18mm-2.50 x 140mm bolt class 10.9 yellow zinc
4	18mm-2.50 prevailing torque nut yellow zinc
8	3/4" SAE flat washer yellow zinc
1	Diff Mount Spacer
1	Bolt Pack 422
4	3/8"-16 x 1-1/4" bolt grade 8 yellow zinc
4	3/8"-16 prevailing torque nut yellow zinc
8	3/8" USS flat washer thru-hardened yellow zinc
1	Bolt Pack 850
2	9/16"-12 x 4" Bolt - Grade 8 - Yellow Zinc
4	9/16" SAE Washer - Yellow Zinc

2	9/16"-12 Prevailing Torque Nut
1	14mm-2.00 x 120mm Bolt - Class 10.9 - Clear Zinc
1	14mm Washer - Clear Zinc
1	1/2"-13 x 1-1/2" Bolt - Grade 8 - Yellow Zinc
1	1/2"-13 Prevailing Torque Nut - Yellow Zinc
2	1/2" SAE Washers - Yellow Zinc
1	1/4"-20 Nylock Nut- Clear Zinc
1	1/4" SAE Washer - Clear Zinc

Box Kit ZONC2663 or ZONC2664 6" Box Kit

Box Kit ZONC2403 4" TrailBoss / AT4 Kit

Box Kit ZONC2400 4" ZR2 / AT4X Kit

Qty	Part
1	DRV Differential Skid Plate
1	Bolt Pack 851
8	Wire Clamp
7	6mm-1.00 x 12mm Bolt - Class 8.8 - Clear Zinc
7	1/4" SAE Washer - Clear Zinc
2	1/2"-13 x 1-1/2" Bolt - Grade 5 - Clear Zinc
2	1/2"-13 x 3" Bolt - Grade 5 - Clear Zinc
6	1/2" SAE Washer - Clear Zinc
2	1/2"-13 Prevailing Torque Nut - Clear Zinc
1	Bolt Pack 629 - Strut Spacers
6	10mm-1.50 lock nut
6	3/8" USS washer
4	Cable Ties
2	CV Spacer
1	Loctite
2	Strut Spacer - 6" (C2663, C2664 Box Kit)
2	Strut Spacer - 4" (C2403, C2400 Box Kit)
2	Rear Lift Block 5" (C2663, C2400, C2403 Box Kit)
4	9/16" x 2-9/16" x 12-1/2" Square U-Bolts (C2663, C2400, C2403 Box Kit)
2	Bump Stop Spacer
1	Bolt Pack 852
2	10mm-1.50 x 100mm Allen head bolt black oxide
3	8mm - 1.25 x 60mm Bolt - Class 8.8 - Clear Zinc
3	5/16" SAE Washer - Clear Zinc
3	5/8" Spacer Tubes
8	9/16" High Nuts
8	9/16" SAE Washers
2	5" Adaptive Ride Rear Shock Bracket (C2664 Box Kit)
2	3" Rear Shock Bracket (C2400 Box Kit)
4	0.75" x 0.083" x 1.375" Sleeve (C2664, C2400 Box Kit)
1	Bolt Pack 854 ARC Brackets (C2664, C2400 Box Kit)
2	Front ARC Sensor Brackets (C2664 Box Kit)

6" Tire/Wheel Fitment

Trimming may be required

*This includes 4" Trail Boss, ZR2, AT4X, and AT4 Kits

*See Pre-Installation Notes

**Trimming IS required

Chevy:

35 x 12.50 on 17x8, 17x9 w/ 4.5" BS

35 x 12.50 on 20x9, 22x9 w/ 4.5-6.25" BS

37 x 12.50 on 20x9, 22x9 w/ 5.5-6.25" BS**

GMC:

295/70 on 17x8, 17x9 w/ 4.5" BS

295/65 on 20x9 w/ 4.5-6.25" BS

35 x 12.50 on 20x9, 22x9 w/ 5.5-6.25" BS

4" Tire/Wheel Fitment

Trimming may be required

*See Pre-Installation Notes

**Trimming IS required

Chevy:

33 x 12.50 on 17x8, 17x9 w/ 4.5" BS

33 x 12.50 on 20x9, 22x9 w/ 4.5-6.25" BS

35 x 12.50 on 20x9, 22x9 w/ 5.5-6.25" BS

GMC:

295/65 on 17x8, 17x9 w/ 4.5" BS

295/60 on 20x9 w/ 4.5-6.25" BS

35 x 12.50 on 20x9, 22x9 w/ 5.5-6.25" BS**

PRE-INSTALLATION NOTES

1. Requires frame bracket modification and welding.
2. Control arms typically add 1-2 degrees caster above stock alignment specifications.
3. All aftermarket wheels should be test fit prior to mounting the tire to ensure proper clearance to the brake caliper. Some wheel profiles will not clear the brake caliper. These can be test fitted before the vehicle is lifted.
4. 17" wheels with 4.5" backspacing should be test fit prior to mounting the tire to ensure proper clearance to the steering knuckle/tie rod.
5. Stock 20" Wheels (6.25" Backspacing) can be installed, stock 17" or 18" Wheels CAN NOT be installed.
6. 6" Kit will NOT work with TrailBoss or AT4 Models. Box Kit C2403 is for Trail Boss / AT4 Models.
7. Box Kit C2664 (6") will with Adaptive Ride Control (ARC) Equipped Vehicles.
8. Front skid plate will not work with 2.7 Turbo Models.
9. O-rings in factory steering knuckle will be reused. Take care not to damage O-rings on disassembly and assembly
10. When disassembling the steering knuckle from the truck, be careful not to drop the CV shaft on to the top of the lower ball joint. The top of the lower ball joint has very sharp edges that can cut the CV boot.
11. If possible, do not remove the CV shafts from the front differential. The CV retaining clips will need to be replaced if the front CV shafts are removed.
12. Replacement ball joint is ZONF8202, use this for replacement purposes if a new ball joint is ever needed. Ball joint is directional and must be installed with the 'dot' facing either inward or outward on the vehicle, otherwise damage may occur.

Front Disassembly

1. Park the vehicle on a clean, flat surface and block the rear wheels for safety.
2. Disconnect the positive and negative battery cables from the battery.
3. Raise the front of the vehicle with a hydraulic jack and support the frame with jack stands. Remove the wheels.
4. Remove the ABS line and brake sensor from the retaining clips at the frame, upper control arm and knuckle. Disconnect the brake line bracket from the steering knuckle Fig. 1. Save bolt.

Important—measure before starting!

Measure from the center of the wheel up to the bottom edge of the wheel opening

LF _____ RF _____

Step 3 Note

If an impact wrench is not being used, the CV axle nut will need to be removed with the weight of the vehicle on the wheel.



Figure 1A

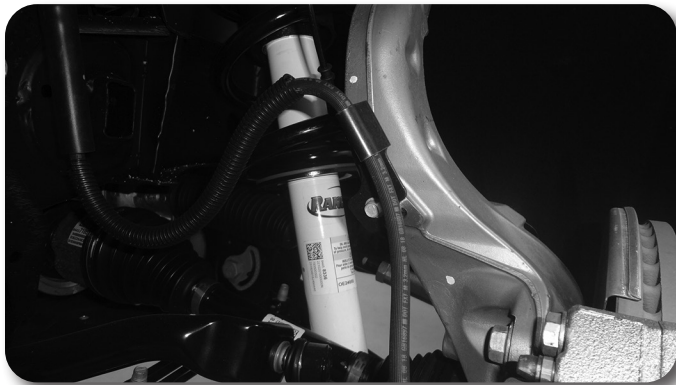

Figure 1B

5. Remove the ABS sensor from the steering knuckle Fig. 2.

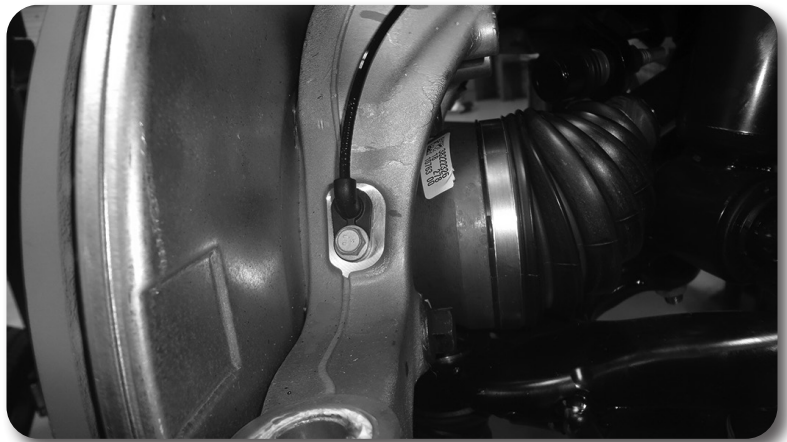

Figure 2

6. Remove the splash guard from the vehicle Fig. 3.



Figure 3

7. Remove the tie rod end nut. Disconnect the tie rod from the knuckle Fig. 4.
Aluminum Knuckle: Avoid striking the knuckle, typically the taper unseats more easily and gently hitting the end of the tie rod end will unseat the taper. A pickle fork can also be used. Save the mounting nut.

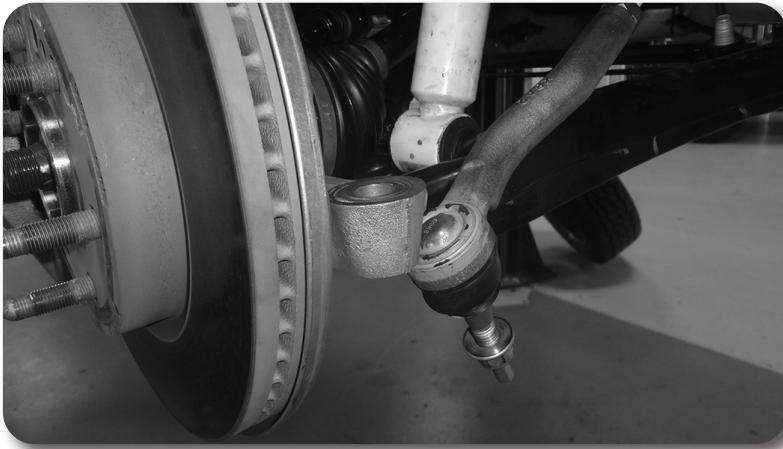

Figure 4

8. Remove the two brake caliper mounting bolts and remove the caliper from the knuckle Fig. 5. Hang the caliper securely out of the way DO NOT hang the caliper by the brake hose. Save caliper bolts.

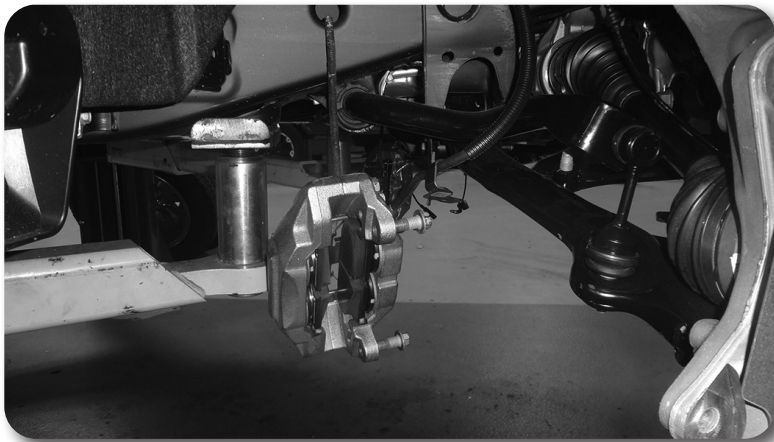

Figure 5

9. Remove the brake rotor retaining bolt and remove the rotor from the vehicle.

Step 10 Note

The axle nut will require a 36mm socket.

10. Remove and retain the axle shaft nut Fig. 6.

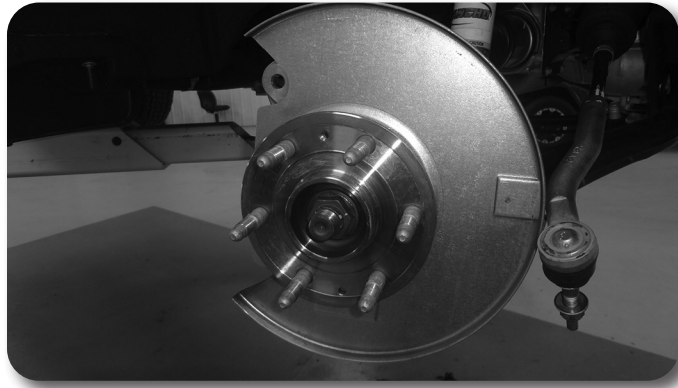

Figure 6

11. Remove the sway bar links nut from the lower control arms Fig. 7. Save the hardware.

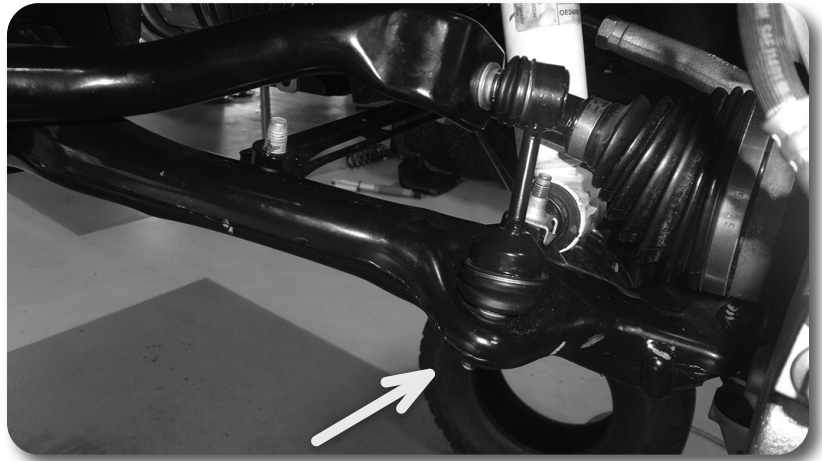

Figure 7

Step 12 Note

Mark D and P on the sway bar to indicate driver and passenger side for orientation when reinstalling the sway bar.

12. Mark the orientation of the sway bar and remove it from the frame by removing the four bushing cap mounting bolts Fig 8. Save all sway bar components, the hardware can be discarded.

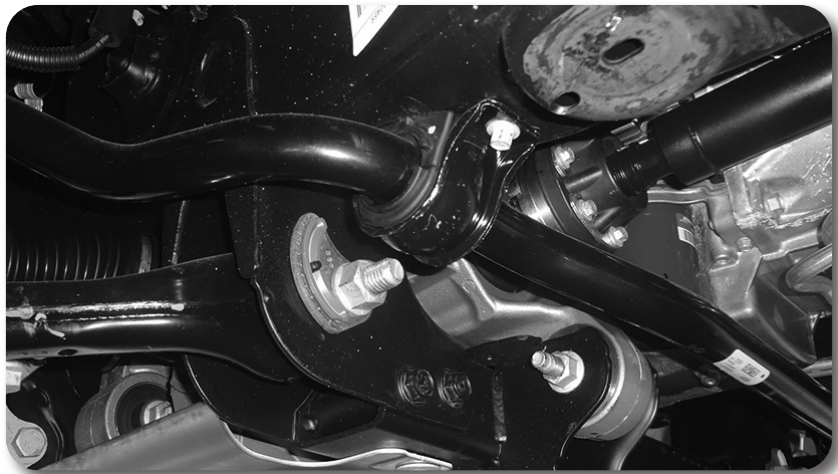

Figure 8

13. Remove the upper and lower ball joint nuts and thread back on by hand a couple of turns. **Aluminum Knuckles:** Avoid striking the knuckle to release the taper, recommended to use a ball joint separator tool to release the taper. If you do resort to hitting the knuckle avoid re-use and discard. Avoid damage to the ball joint boots during installation. Fig. 9 & 10

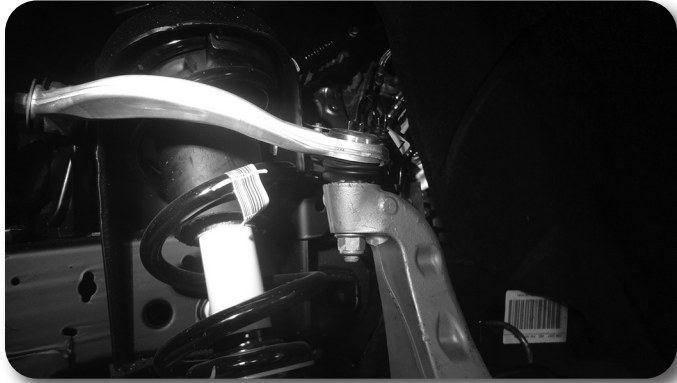

Figure 9

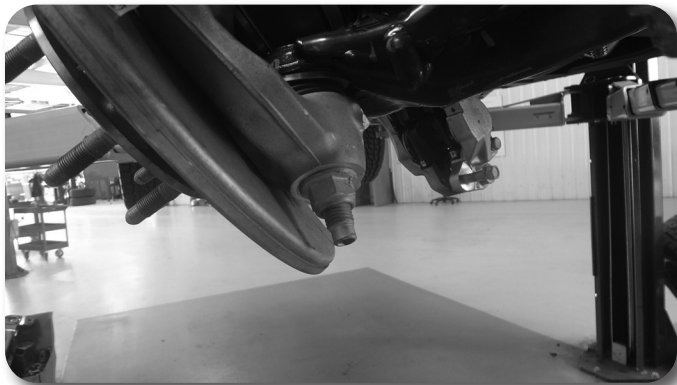

Figure 10

14. Mark each of the front strut bodies to indicate driver's versus passenger's side.
15. **Denali Models (ARC models) only:** Disconnect the wire harness to the lower strut body for the ARC system Fig 11A. Remove the wire harness from the lower control arm.

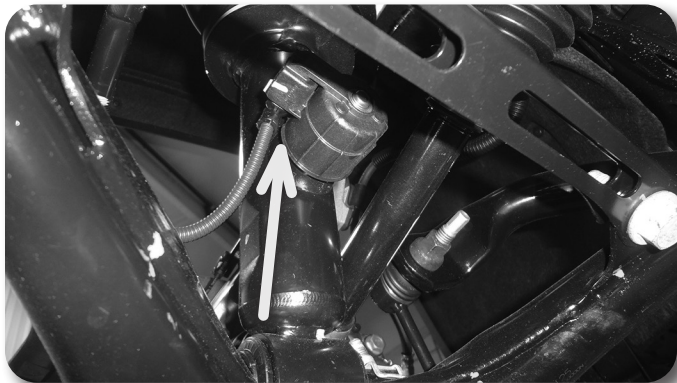

Figure 11A

16. Support the lower control arm with a jack. Remove the upper ball joint nut and the lower strut mount bolts Fig. 11B. Save bolts. Swing the knuckle / lower control arm down to remove the CV shaft from the hub. Retain ball joint nut and strut bolts.



Figure 11B

17. Remove the lower ball joint nut and remove the knuckle from the vehicle. Retain hardware.
18. Remove the front and rear lower control arm mounting bolts and remove the lower control arm from the vehicle. Save mounting hardware and control arms.
19. Remove the three upper strut mounting nuts Fig. 12 and remove the strut from the vehicle. DO NOT remove the center strut rod nut, it is under extreme pressure. Save nuts.

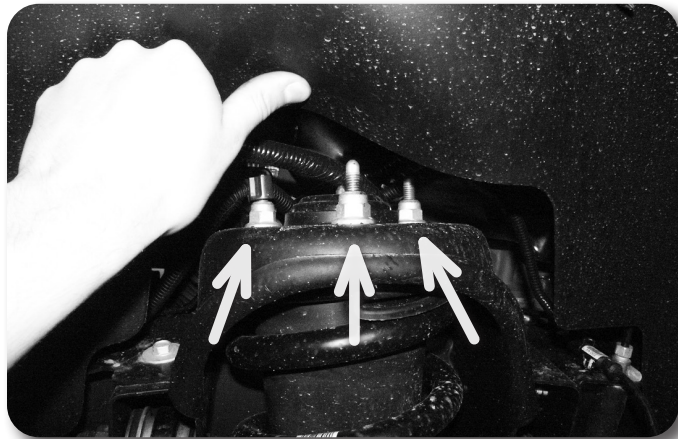

Figure 12

20. Make an alignment mark to show the relationship between the front driveshaft and the differential yoke. Remove the six driveshaft bolts and disconnect the driveshaft from the differential. Save bolts Fig. 13.

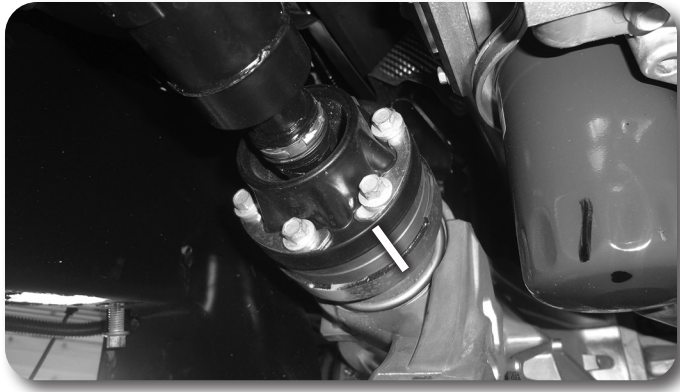

Figure 13

21. Remove the bolt attaching the differential to the rear cross member Fig. 14. Save hardware for later installation.



Figure 14

22. Remove the factory rear cross member from the vehicle by removing the 4 bolts Fig 15. Crossmember and hardware will not be reused.



Figure 15

Step 23 Note

If you are having difficulty accessing the plug, wait until the differential is being lowered to disconnect it.

23. Disconnect the differential actuator wire connector from the actuator Fig. 16.



Figure 16

Step 24 Note

The differential may need to be lowered a little bit to disconnect the breather hose. This can be done as the differential is being removed.

24. Disconnect the differential breather hose Fig. 17. Shown with differential already removed for clarity.



Figure 17

Step 24 Note

Diesel Models Only: Remove the transmission cooler line near the from drive shaft attached to the transmission.

Step 25 Note

We highly recommend having an assistant to help with removal of the front differential.

If possible, do not remove the CV shafts from the front differential. The CV retaining clips will need to be replaced if the front CV shafts are removed.

25. Support the front differential with an appropriate jack. Remove the driver's side differential mounting bolts Fig. 18. Save mounting bolt hardware.

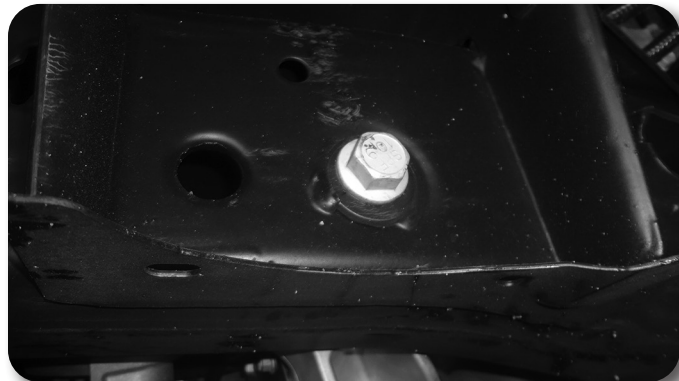

Figure 18

Step 26 Note

The bolt holding the actuator may need to be removed in order to aid in removal of the long bolt for the differential. The bolt is on the right side in Figure 19B. Reinstall the bolt for the actuator after it has been removed. It also helps to push the rear of the differential upwards to point the bolt head downwards to aid in removal.

26. Remove the nut from the passenger's side differential mounting bolt Fig. 19A. Carefully lower the differential to the ground while removing the long bolt for the passenger's side differential mount Fig. 19B. Discard the bolt, save the nut for

later installation. Do not remove the CV shafts if possible. If removed the CV shafts will need the retaining clips replaced.

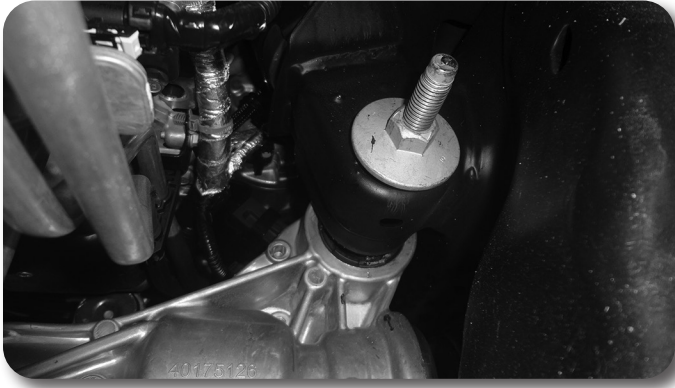

Figure 19A

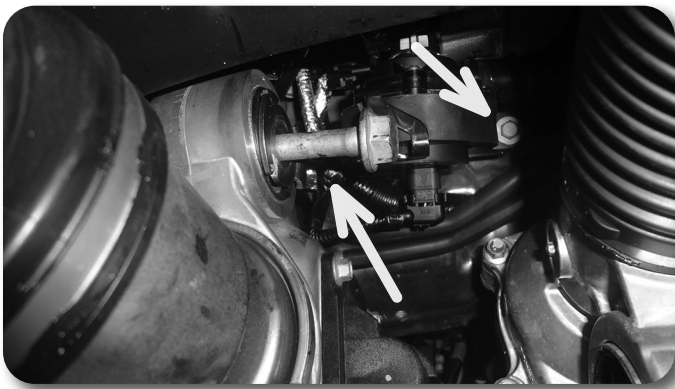

Figure 19B

Frame Clearance

27. The driver's side rear lower control arm pocket must be cut to provide clearance for the front differential in the relocated position. This area needs to be cleaned of any oil, grease and/or undercoating. These coatings are flammable.
28. Measure from the inside of the driver's side rear control arm pocket out 2-9/16" and mark Fig. 20A. Repeat this measurement on the opposite side of the pocket. Make vertical cut lines at the 2-9/16" mark up both front and back faces of the pocket Fig. 20B.

Step 27 Note

A putty knife and parts cleaning solvent work well to remove undercoating.



Figure 20A

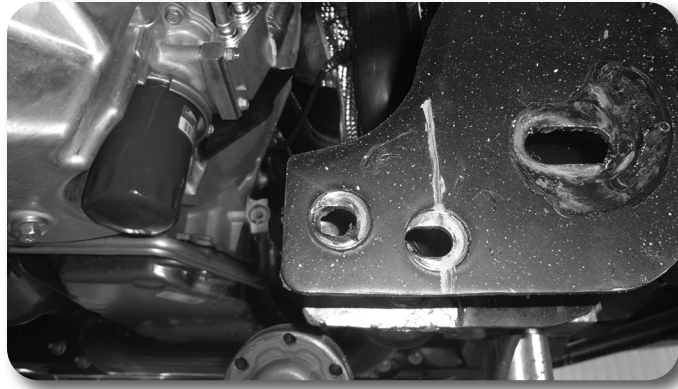

Figure 20B

29. Make a vertical cut along each of the cut lines on the front and back faces of the control arm pocket with a reciprocating saw (recommended), cut-off wheel or plasma cutter. Be careful, the undercoating on the frame is flammable and can melt and drip off the frame. Keep a fire extinguisher near by.
30. With the vertical cuts complete, cut the top portion of the pocket by connecting the two cuts.
31. The bottom front of the rear lower control arm pockets must be cut to provide clearance for the rear cross member. This area needs to be cleaned of any oil, grease and/or undercoating. These coatings are flammable.
32. Measure down 1-3/8" from the bottom edge of the rear control arm bolt hole on both the driver and passenger sides Fig. 21A & C. The passenger side will also have a vertical cut 1-3/4" in from the edge of the pocket as shown in Figure 21B & D.

Step 31 Note

A putty knife and parts cleaning solvent work well to remove undercoating.

Step 32 Note

This will only need to be done on the front of the rear lower control arm pocket. On the passenger side do NOT cut out the inner most slot as shown in Figure 21D.

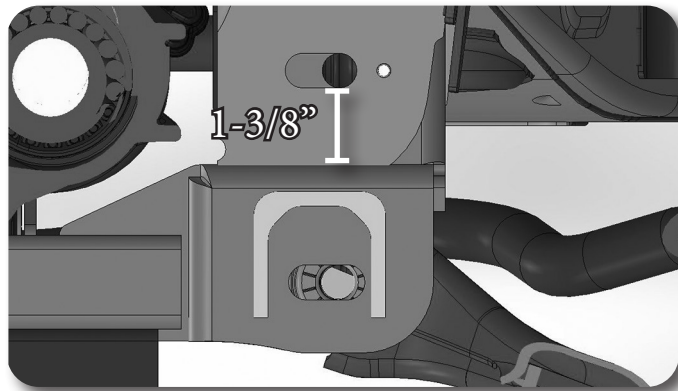

Figure 21A

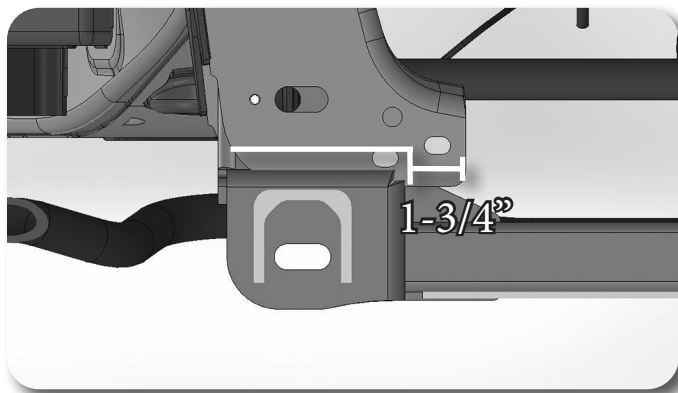

Figure 21B



Figure 21C

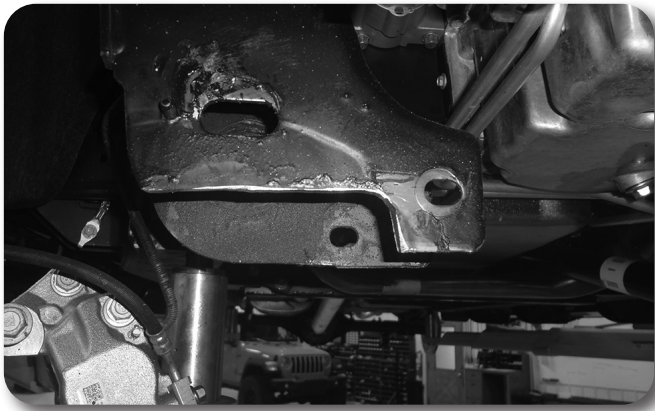

Figure 21D

33. The bottom front of the front lower control arm pockets must be cut to provide clearance for the front cross member. This area needs to be cleaned of any oil, grease and/or undercoating. These coatings are flammable.
34. Make a line parallel with the bottom edge of the front lower control arm pocket as shown in Figure 22 & 23. Trim all the way to the inner edge of the lower control arm pocket.

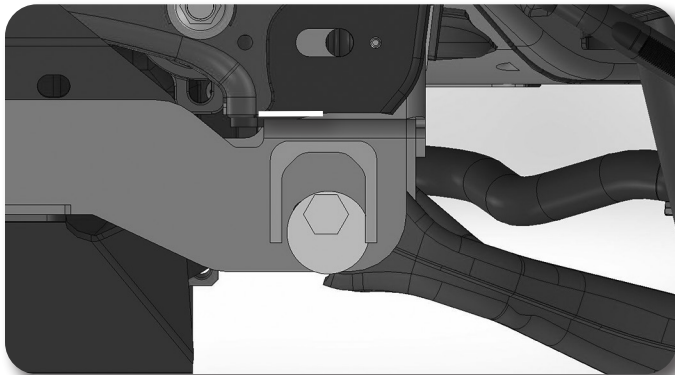

Figure 22

Step 33 Note

A putty knife and parts cleaning solvent work well to remove undercoating.

Step 34 Note

This will only need to be done on the front of the front lower control arm pocket. Additional grinding may be required on the lower control arm pocket for crossmember clearance.



Figure 23

Front Installation

35. Install the new driver's side differential bracket to the original mount with the factory long bolt Fig. 24 & 25. Let the bracket hang until the differential is mounted in a later step. Leave hardware loose.

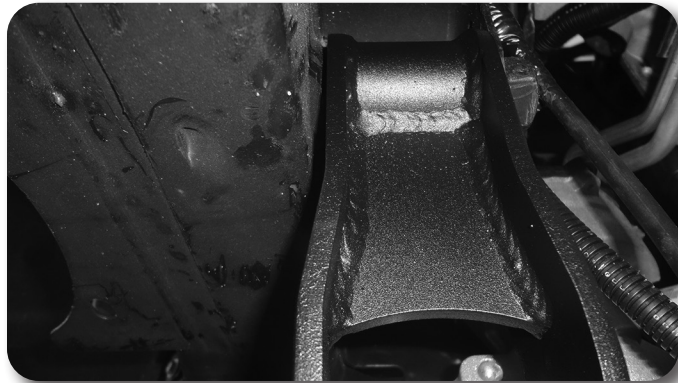

Figure 24

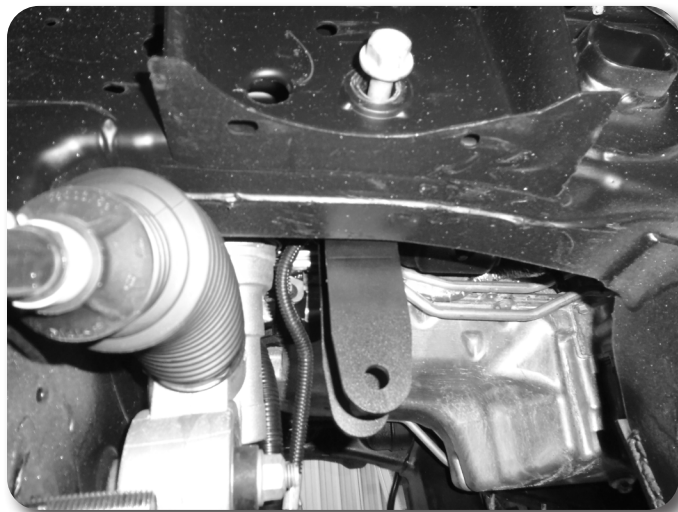

Figure 25

Step 36 Note

The hardware for the crossmembers is located in bolt pack 585.

The front crossmember will offset forward on the vehicle.

36. Install the front cross member in the control arm pockets with the provided shorter 18mm bolt, prevailing torque nuts, and washers Run bolts from front to rear Fig. 26. Leave hardware loose.

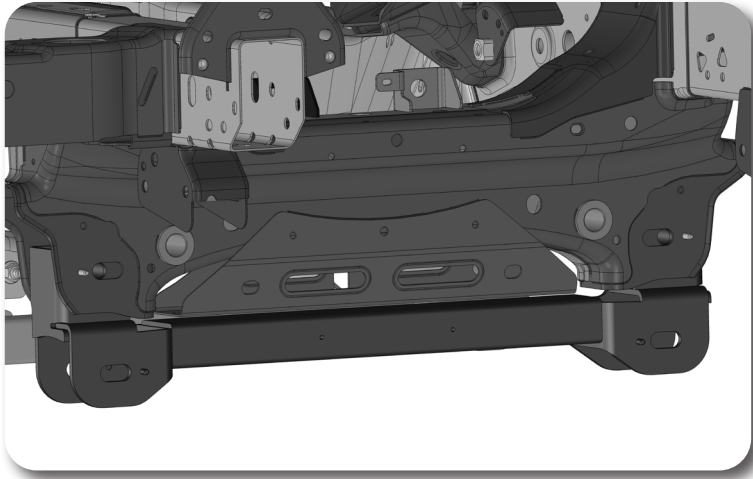

Figure 26

37. Install the new passenger's side differential bracket and brace to the original mounting location with the new 14mm bolt, 14mm washer, and factory nut Fig. 27. Snug up hardware, but do not tighten. The differential brace will mount to the alignment pin and into the slot from the factory rear cross member.



Figure 27

38. Install the provided 1/2" x 1-1/2" bolt, 1/2" SAE Washers, and 1/2" Prevailing torque nut through the slot on the factory rear cross member and the differential brace Fig. 28. Leave hardware loose.

Step 37 Note

The hardware for the differential drop is located in bolt pack 850.

Step 38 Note

The hardware for the differential drop is located in bolt pack 850.

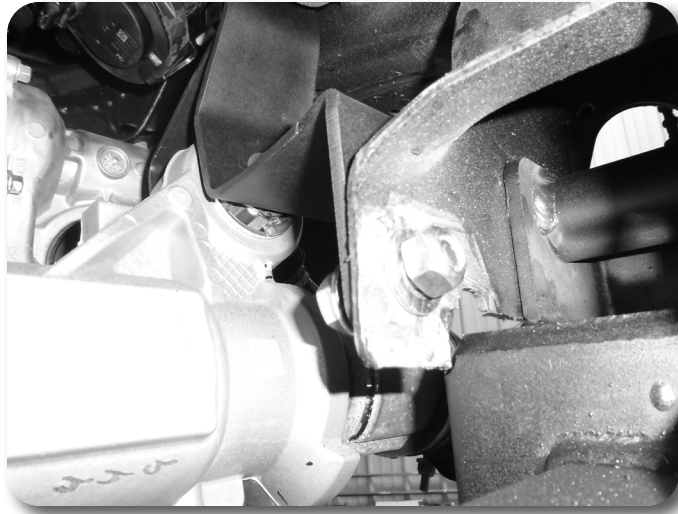

Figure 28

Step 39 Note

When installing the passenger's side differential mount install the spacer (Figure 29B) with the differential into the slotted mount. The spacer takes up the gap created from the flange on the differential mount.

39. Install the differential to the new driver's and passenger's differential brackets. Loosely attach the differential to both differential drop brackets with 9/16" x 4" bolts, prevailing torque nuts, and washers Fig 29 C & D. The passenger's side differential bracket will use a spacer on the front side between the bushing and the differential bracket Fig. 29A & B.

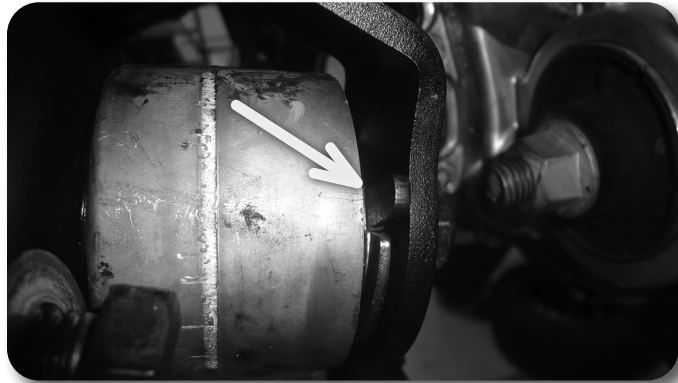

Figure 29A

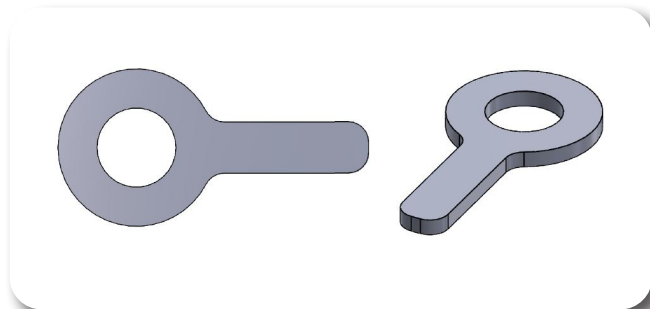

Figure 29B



Figure 29C

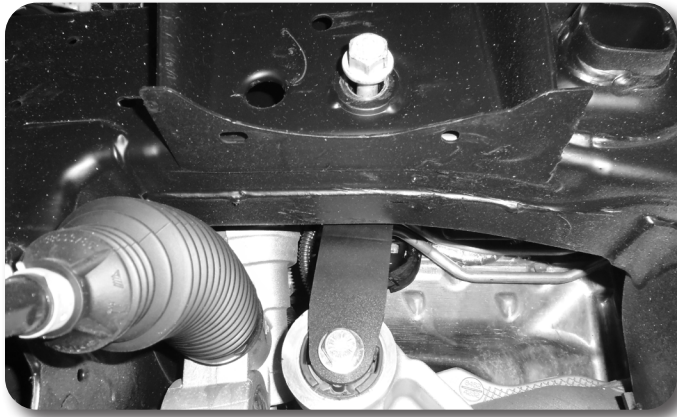

Figure 29D

40. Install the new rear cross member with the provided longer 18mm bolt, prevailing torque nuts, and washers. The tabs on the cross member should align with the center differential bracket. Run the bolts from front to rear. Leave hardware loose. Fig. 30.

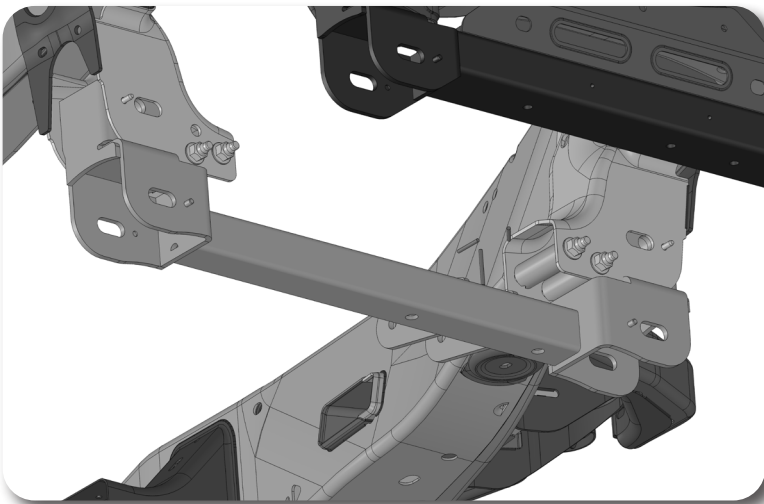

Figure 30

41. Install the factory bolt and nut through the differential mount on the rear cross member Fig. 31. Leave hardware loose.

Step 40 Note

The bolts for the differential may need to be removed one side at a time in order to install the 18mm bolts for the rear crossmember. It is also possible with the differential hardware being loose to move the differential out of the way enough to install the 18mm crossmember bolts.

Step 43 Note

The breather line may need to be accessed through the engine compartment to be rerouted for more slack.

Step 44 Note

Thread locker will dry quickly, make sure the next steps are performed in a timely manner to prevent the thread locker from drying.

Step 45 Note

The hardware for the transmission line drop bracket is located in bolt pack 850



Figure 31

42. Reconnect the differential actuator wiring. Reattach the wire to the differential housing with the factory clips.
43. Reconnect the differential breather line. The line may need to be removed from retaining clips above to gain slack.
44. Remove the nut and washer from the back side of the rear cross member bolt. Install the sway bar drop brackets into the 18mm bolt for the rear cross member. Reinstall the nut and washer for the rear cross member bolt. Snug up the sway bar drop bracket to the frame with thread locker and the factory 10mm bolts. Do not tighten the sway bar to frame bolts at this time Fig. 32

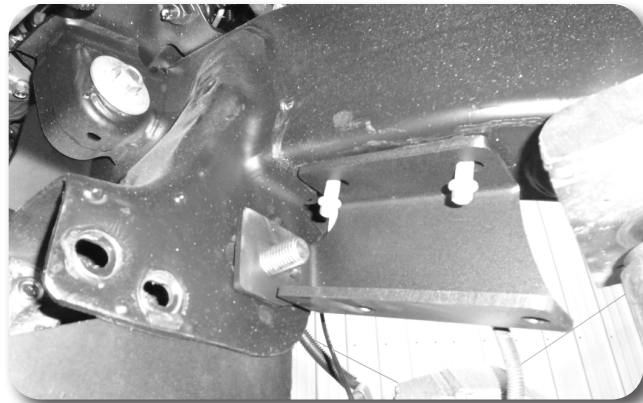

Figure 32A

45. **DIESEL MODELS ONLY:** Install fuel line drop bracket as shown in Fig. 32B & 32C, Attach using factory hardware on top mount and provided 1/4" hardware on stud side of bracket. Install the OE lower control arms in the new crossmembers with the factory cam bolts. Run the front bolts from front to rear. Run the rear bolts from rear to front. Leave hardware loose.

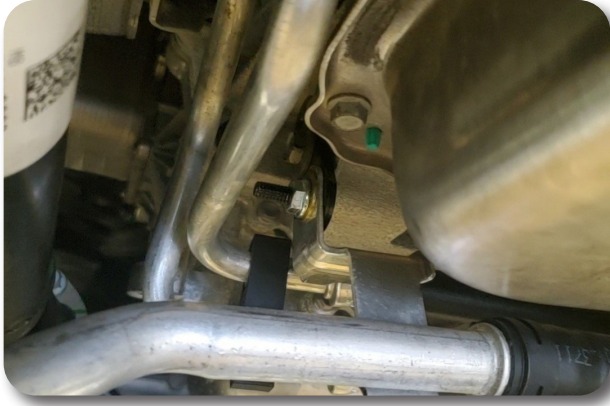

Figure 32B

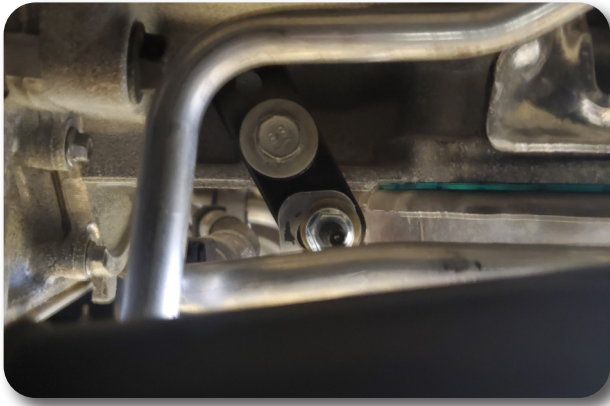

Figure 32C

46. Tighten all 18mm hardware for the front and rear cross members to 250 ft-lbs. Torque all differential mount hardware: 1/2" hardware to 65 ft-lbs, 9/16" & 14mm hardware to 90 ft-lbs. Torque the 10mm sway bar drop hardware to 45 ft-lbs.
47. Reinstall the front driveshaft using the factory hardware and thread locker. Torque the hardware to 48 ft-lbs.
48. Loosely attach the differential skid plate to the front cross member with the two 1/2" x 1-1/2" bolts and washers in the threaded holes and two 1/2" x 3" bolts, washers, and prevailing torque nuts through the two holes in the rear cross member. Torque all 1/2" hardware to 45 ft-lbs. Fig. 33

Step 48 Note

The hardware for the skid plates is located in bolt pack 851.



Figure 33

Step 49 Note

Make sure not to damage the O-rings on removal and installation into the new steering knuckle.

Step 50 Note

Check for clearance to the brake caliper after installation.

49. Remove the hub bearing/rotor assembly and brake dust shield from the factory steering knuckles. Remove the two O-rings on the knuckle. Be sure to note which hub goes on which side of the vehicle. Save mounting bolts.
50. The brake dust shield needs to be trimmed on both the driver and passenger sides. Measure in from the lower vertical edge 1-1/4" and make a cut as shown in Figure 34A. The upper edge will need to be cut at a 45 degree angle as shown in Figure 34A on the upper right side. Figure 34 A & B show the cut to clear the brake caliper. The cuts will be mirror images on the passenger side as to what is shown in the pictures.

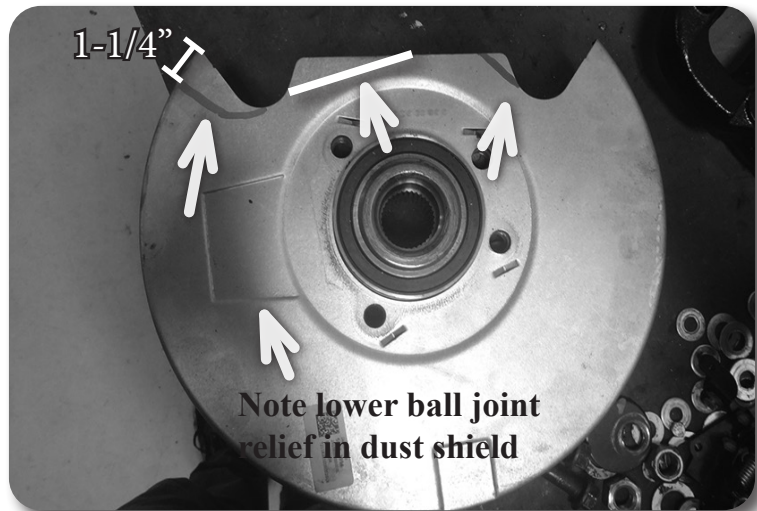

Figure 34A DRIVER SIDE SHOWN

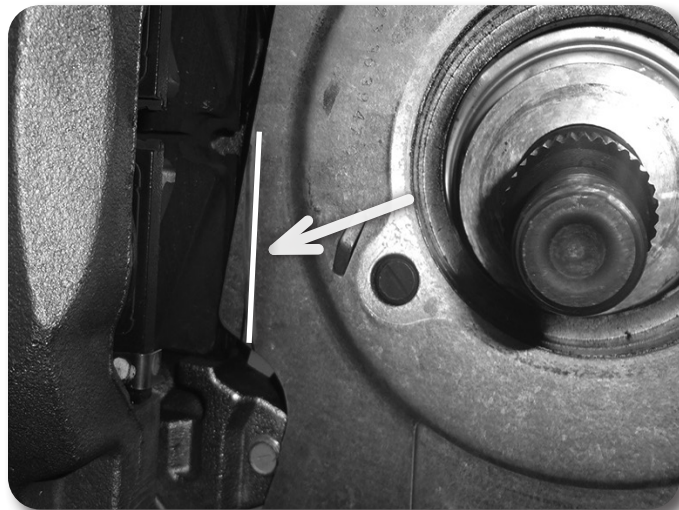

Figure 34B

51. Install the modified dust shield on the corresponding new knuckles. Install the two O-rings on the new knuckle. Fasten the hub/shield with the OE bolts. Apply thread locker to the bolt threads and torque to 111 ft-lbs and a final pass of 30-45 degrees.

Control Arm Installation

52. Remove the stock upper control arm from the vehicle by removing the two bolts attaching the upper control arm to the strut bucket / frame Fig. 35. Save hardware. If replacing the upper arm on a Denali truck, remove the sensor arm from the ball stud on the upper control arm.

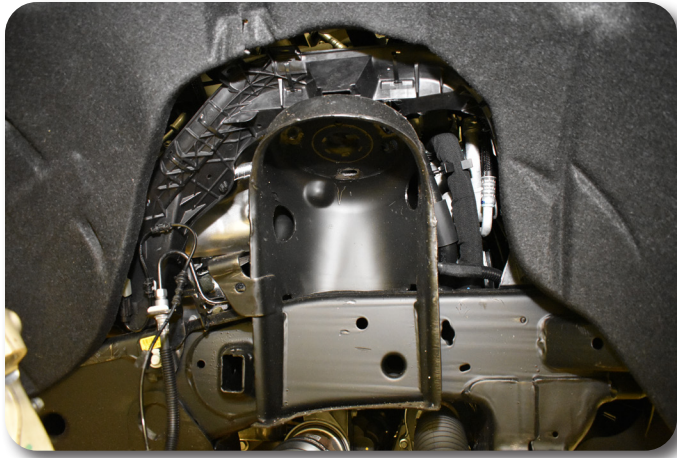

Figure 35

53. The new replacement control arm assemblies have a larger profile than the OEM assemblies. They are also designed with a wider range of available travel. Due to these unique differences, the tab on the side of the strut bucket must be removed to avoid interfering with the proper function of the new control arm assembly. Cut the tab from the side of the strut bucket as shown in Figure 36.

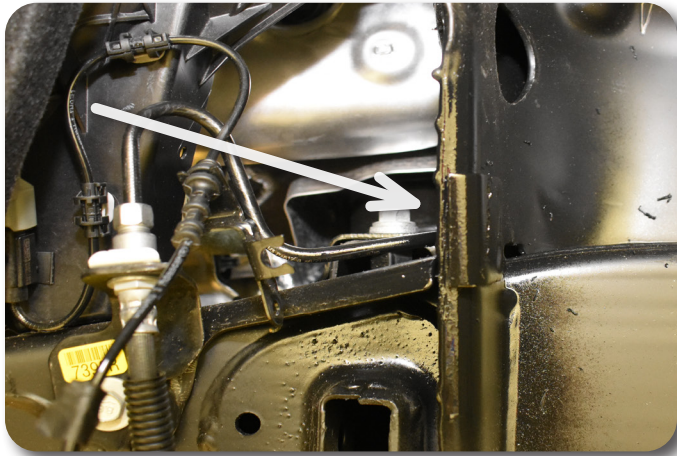

Figure 36

54. Install the new upper control arm to the vehicle using the **new provided 14mm bolts, washers, and nuts from Bolt Pack 640 and using thread locker**. Run the bolt with a washer from the inside out of the strut bucket outwards with a washer and nut on the outer bushing washer surface. Do this for the front and rear control arm mounts. Fig. 37. Snug up hardware.



Figure 37

Step 55 Note:

The UCA hardware is located in Bolt Pack 640.

IMPORTANT

FAILURE TO FOLLOW PROCEDURE FOUND IN STEP 55 CAN RESULT IN BUSHING DAMAGE.

Step 55 Note

The OE nylock nut will only be temporarily used to set the control arm at the correct ride height so that the rubber bushing preload is correct. **DO NOT USE THE OE NYLOCK NUT FOR THE FINAL INSTALL.**

55. Install the CV shaft spacer (05037) on the CV stub shaft with the chamfered edge facing towards the inside of the vehicle Fig 38A. Install the assembled knuckle on the lower control arm and loosely fasten with the original lower control arm nut Fig. 38B. Install the CV shaft assembly in the hub, swing the whole assembly up and attach to the new upper control arm to the knuckle assembly using the OE Nylock Nut. Snug up ball joint using the OE Nylock Nut, but do not torque down. The upper ball joint will be removed from the knuckle later so that the strut can be installed.

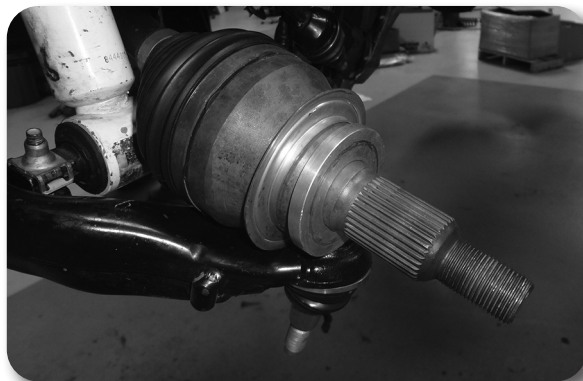

Figure 38A

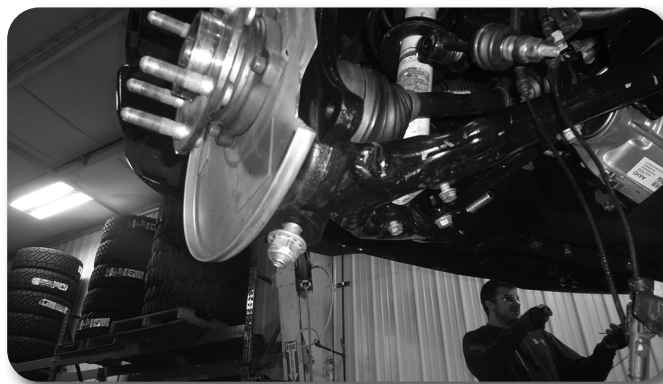

Figure 38B

56. Torque the lower ball joint nut to 37 ft-lbs and then a final pass of 125-135 degrees per the factory specification.

57. Using a jack, set the ride height from the fender lip to the center of the hub at 28-1/2" (6" regular or 4" Trail BOSS/ AT4 Kits) or 26-1/2" for 4" regular truck (Non-TB/AT4). **Using a torque wrench on the inside of the strut bucket and a wrench on the outside bushing to prevent the nut / bushing from moving,** tighten the control arm hardware to **126 ft-lbs**. This will ensure the rubber bushings are tightened to the right position and not put preload in the rubber bushings. **DO NOT** spin the "bushing side" hardware when tightening, only tighten from the inside "frame side". Fig. 39A & 39B

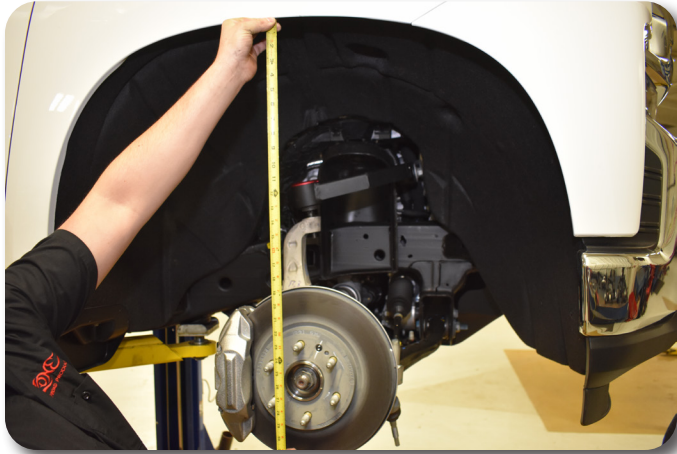

Figure 39A

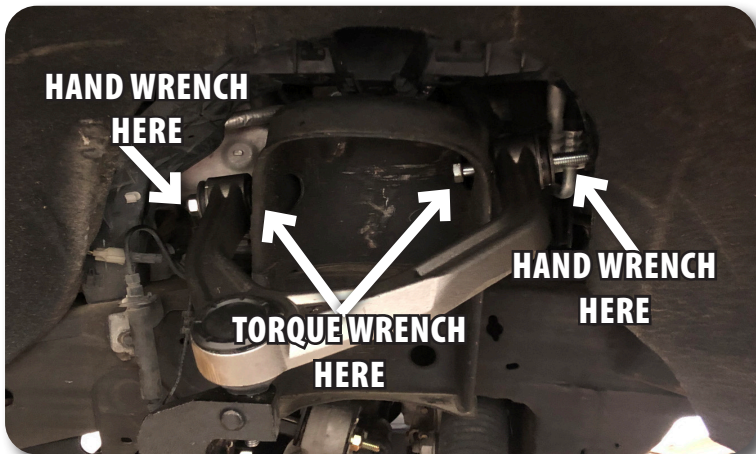

Figure 39B

Strut Installation

58. Install the provided strut spacers on the strut with the provided 10mm prevailing torque nuts and washers. The spacers will only install one way Fig. 40. Torque hardware to 30 ft-lbs.

Step 58 Note
The hardware for the strut spacers is located in bolt pack 629.

Step 59 Note

Be sure that the strut is oriented properly in the vehicle.

Step 61 Note

DO NOT use the OE Nylock Nut.
Use the provided nylock nut in Bolt Pack 874.

Step 61 Note

Denali Models Only: Install the ball stud removed from the factory arm into the replacement Zone arm.

Step 62 Note

This may need to be done on the ground with the weight of the vehicle.

Step 64 Note

The hardware for the knuckles is located in bolt pack 851.

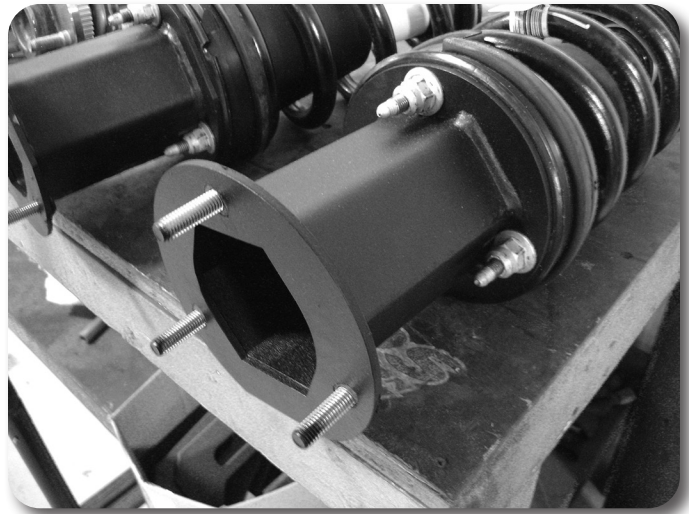

Figure 40

59. Remove the upper ball joint nut and swing the knuckle out of the way. Discard the OE ball joint nut. The lower control arm may need to be lowered to install the new strut assembly. Install the new strut assembly to the appropriate frame and lower mount with the factory hardware. Leave hardware loose.
60. Torque the upper strut nuts to 40 ft-lbs and the lower strut bolts to 37 ft-lbs.
61. Reattach the upper ball joint to the knuckle Fig. 41. **Use the provided 12mm nylock nut in bolt pack 874.** Use the jack to support the lower control arm and torque the upper ball joint nut to 26 ft-lbs with the first pass and 60-75 degrees on the final pass.



Figure 41

62. Torque the CV axle nut to 185 ft-lbs.
63. Remove the factory tie rod ends and install the new provided tie rod ends. Leave approximately 5/8" of threads showing on the steering link.
64. Attach the ABS wire to the knuckle with the provided wire clamps and 6mm bolts, washers, and thread locker as shown in Figures 42 & 43. Figure 43 shows the driver side with the brake sensor wire routing along the knuckle as well. Torque hardware to 92 in-lbs.

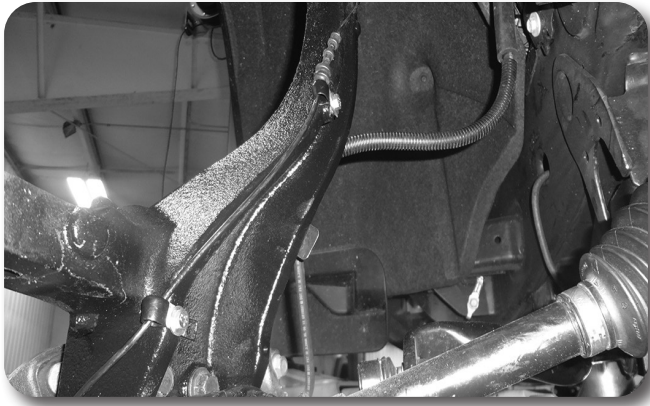

Figure 42

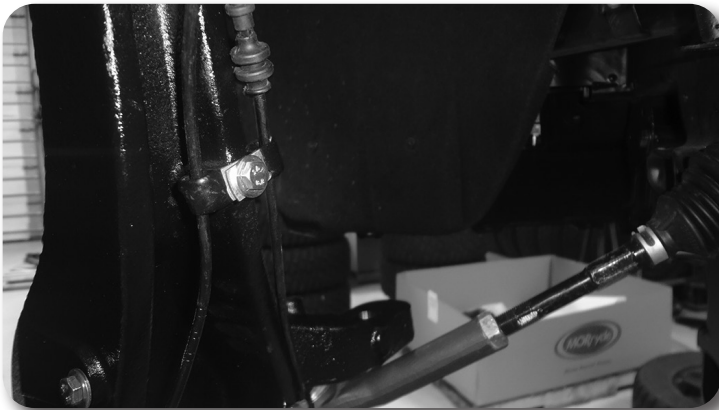

Figure 43

65. Attach the brake sensor plug to the knuckle with the factory bracket and 6mm bolts, washers, and thread locker Fig. 44. Torque to 92 in-lbs.

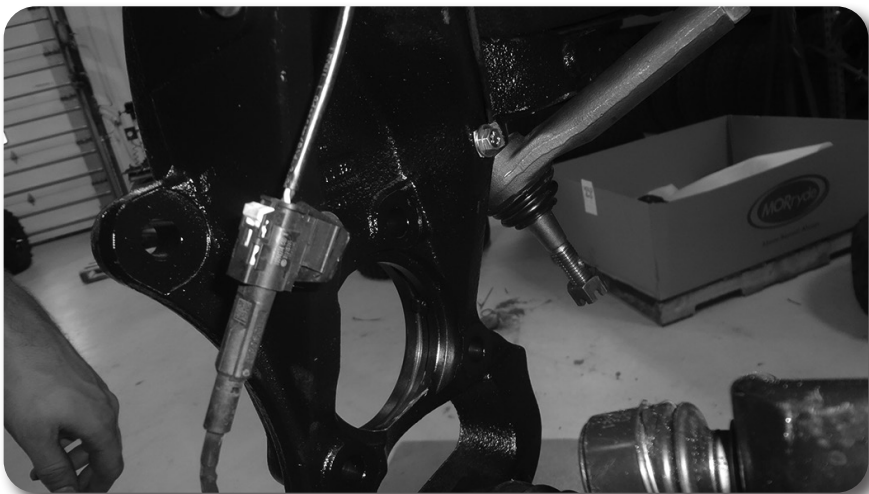

Figure 44

66. Attach the caliper to the new steering knuckle with the original mounting hardware and thread locker. Torque bolts to 37 ft-lbs with a final pass of 30-45 degrees.
67. **2019 Models:** Attach the brake line bracket to the knuckle with the provided 6mm bolt, washer, and thread locker Fig. 45A. The tab on the driver side may need to be cut off to mount to the steering knuckle Fig. 45B. **2020+ Models:**

Attach the brake line to the knuckle with the provided 6mm bolt, washer, and thread locker and wire clamp Fig. 45C. Carefully cut off the factory brake line bracket. Be careful to not cut the brake line. Torque to 92 in-lbs.



Figure 45A

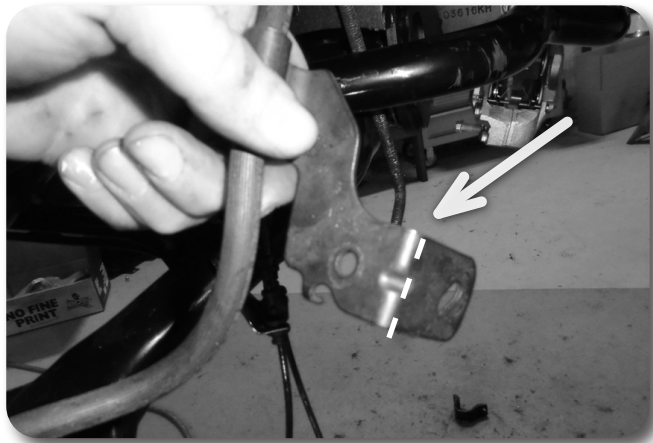

Figure 45B



Figure 45C

Step 68 Note

The driver side is pictured, the driver side will require two wire clamps on the upper control arm for the ABS wire and brake sensor wire. Hardware is in bolt pack 874.

68. Attach the ABS wire and brake sensor wire to the upper control arm on the driver and passenger sides with the provided wire clamps and factory hardware using thread locker Fig. 46. Torque to 92 in-lbs.



Figure 46

69. Attach the front sway bar to the sway bar drop bracket with the provided 3/8" bolts, prevailing torque nuts, and washers Fig. 47. Attach the sway bar link to the front control arms. Torque the sway bar drop hardware to 44 ft-lbs. Torque the sway bar link hardware to 74 ft-lbs

Step 69 Note

The hardware for the sway bar drop is located in bolt pack 422.

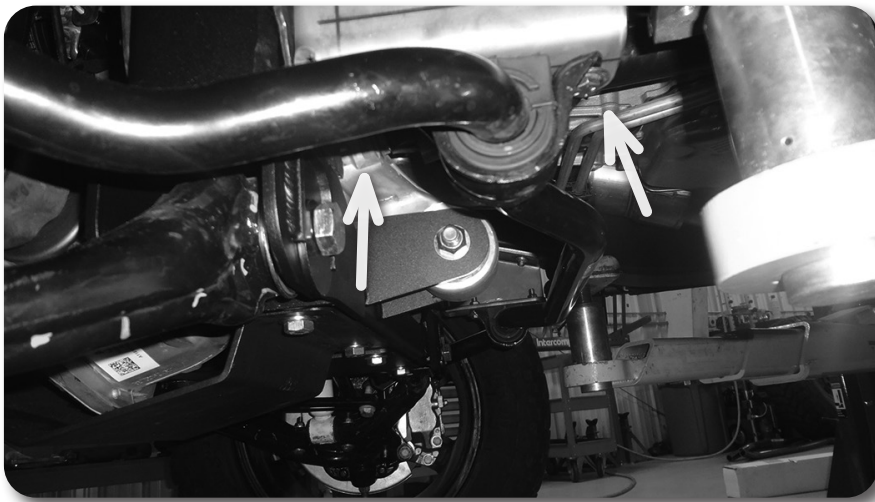

Figure 47

70. Connect the steering tie rod ends to the knuckles with the provided nylock nuts. Torque to 44 ft-lbs. Tighten the tie rod end jam nuts securely. They will be adjusted during alignment. Install the zerk fittings into the tie rod ends.

Denali Models

71. **Denali Models (ARC Models) Only:** Transfer the ball stud to the threaded hole on the front side of the upper control arm Figure 48A. Reattach the sensor arm to the ball stud.

Step 72 Note

The nut needs to be reattached to prevent the stud from falling into the frame when tapped loose.

The ARC sensor can be left attached to the upper control arm or removed for ease of assembly.



Figure 48A

72. **6" Denali Models (ARC Models) Only:** Remove the nut attaching the ARC sensor to the frame Fig. 48B. Lightly reattach the nut to the stud. Tap the stud in until the bracket assembly is loose. Remove the ARC sensor from the frame by prying down on the tab and pulling out on the sensor bracket Fig. 48C.

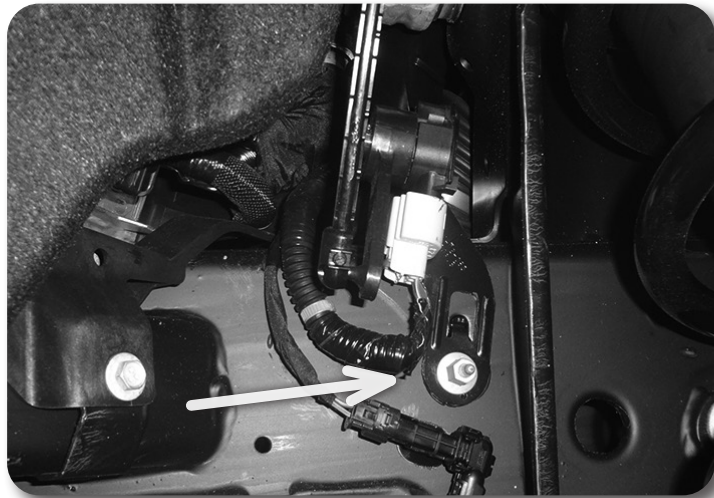

Figure 48B

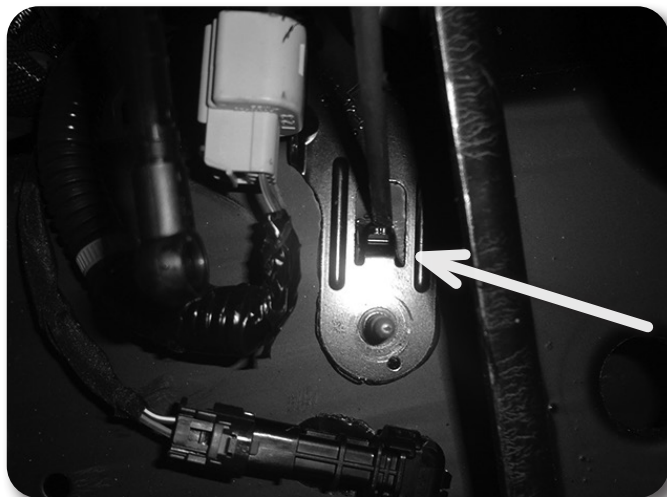

Figure 48C

73. **6" Denali Models (ARC Models) Only:** Remove the bracket from the ARC sensor Fig. 49. Install the new bracket to the ARC sensor with the original hardware. The brackets are side specific and look similar to the factory bracket.

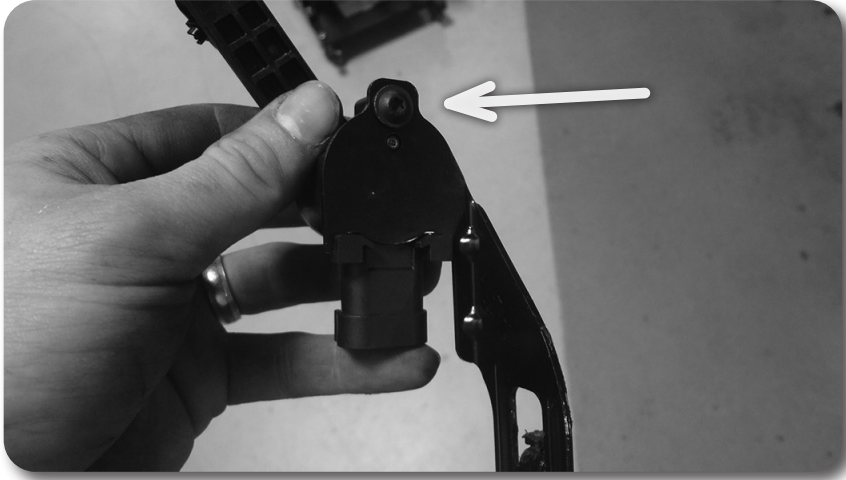

Figure 49

74. **6" Denali Models (ARC Models) Only:** Remove the stud and nut assembly from the factory ARC sensor bracket. Install the stud and nut assembly into the new ARC sensor bracket Fig. 50.



Figure 50

75. **6" Denali Models (ARC Models) Only:** Install the ARC sensor bracket and stud into the frame the same way it was removed. Tighten the nut to 10 ft-lbs.
76. **Denali Models (ARC Models) Only:** Reattach the ARC strut wire harness to the lower control arm, additional slack may be needed. Unclip the wire harness on the frame as needed to gain additional slack. Install the ARC strut wire harness into the ARC strut. If the link has been disconnected from the upper control arm reinstall the link to the upper control arm now.

Front Installation Continued

77. Install the Zone Offroad badge to the front cross member with the provided 3/16" rivets Fig. 51.



Figure 51

78. Install the wheels/tires and lower the front of the vehicle to the ground. Torque lug nuts to 140 ft-lbs.
79. Bounce the front of the vehicle to settle the suspension. Center the cams and torque the lower control arm mounting bolts to 133 ft-lbs and a final pass of 90-105 degrees.
80. **OPTIONAL:** Due to control arm clearance and certain size wheel and tire combinations, a steering stop may be required. These are only needed when the tire hits the upper control arm at full lock. Prep the lower control arm for welding, remove paint. Disconnect the battery in the truck to protect electronics.
81. **OPTIONAL:** Weld steering stop on to lower control arm as shown Fig. 52.

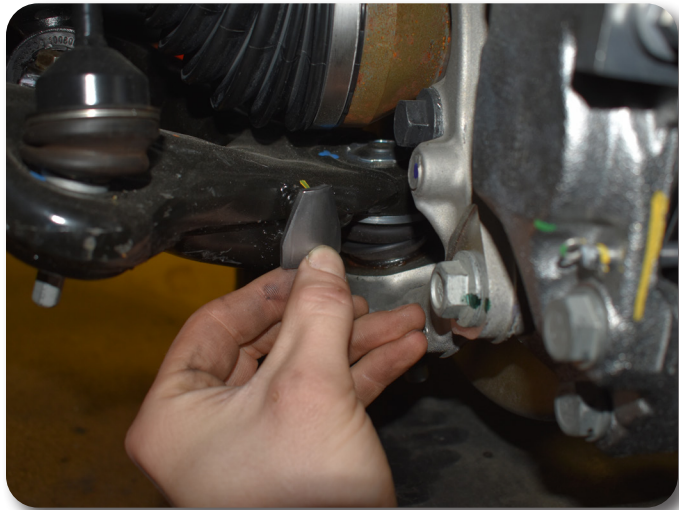

Figure 52

82. Grease the ball joint at this time with 3-4 pumps. Do NOT overgrease the ball joint. Install the o-ring onto the black ball joint cap. Using the provided grease packet, lightly grease the o-ring and install the cap onto the control arm by lightly tapping it down with a rubber mallet.
83. Check differential and CV shafts for clearance in all areas including those cut for clearance.
84. Check all hardware for proper torque.
85. If necessary, bleed the entire brake system. See service manual for proper brake system bleeding procedures.
86. Reconnect the battery cables to the battery.

Rear Installation

1. Block the front wheels. Safely raise the rear of the vehicle and support with jack stands just ahead of the front leaf spring frame mount.
2. Remove the wheels.
3. Support the rear axle with a floor jack.
4. Remove the 3 bolts attaching the rear brake line / ABS bracket to the top of the rear differential Fig. 1. Discard hardware.



Figure 1

5. Support the center of the axle with a hydraulic jack. Remove the factory shocks from the axle and frame. Save hardware and discard shocks.
6. With the axle still well supported remove the passenger's side U-bolts. The factory U-bolts will not be reused. If equipped with a rear lift block, remove and discard the block.
7. Lower the axle just enough to install the new provided lift block between the axle and the spring. Position the block so the male pin side is forward when compared to the female or top of the block. This will assist in shifting the axle forward. Align the pin in the block with the hole in the axle and the hole in the block with the leaf spring pin Fig 2. It may be necessary to loosen the driver's side U-bolts slightly to allow the axle to lower far enough to install the block.



Figure 2

Step 7 Note

Denali Models (ARC Models)
Only: Make sure ARC sensor bracket is installed in the same place as it was from the factory with the rear block located underneath the leaf pack.

- Using the support jack, raise the axle so that the axle, spring and block are all touching. Install the new provided U-bolts, nuts and washers allow with the factory U-bolt plate Fig. 3. Snug U-bolts but do not tighten.



Figure 3

- Repeat the installation on the driver's side of the vehicle. Pay special attention to all of the brake lines and wires. Do not allow them to get over-extended.
- Remove the rear rubber bump stops from the frame. Access the bolt head up through the center of bump stop using a 10mm socket. Remove the bump stop and install the provided 3" diameter x 3" tall spacer between the bump stop and the frame mount with a 10mm Allen head bolt and thread locker. Center the spacer on the lip of the factory bump stop cup and torque bolt to 37 ft-lbs. Fig. 4.

Step 10 Note

Hardware for the bump stop spacer is located in bolt pack 852.

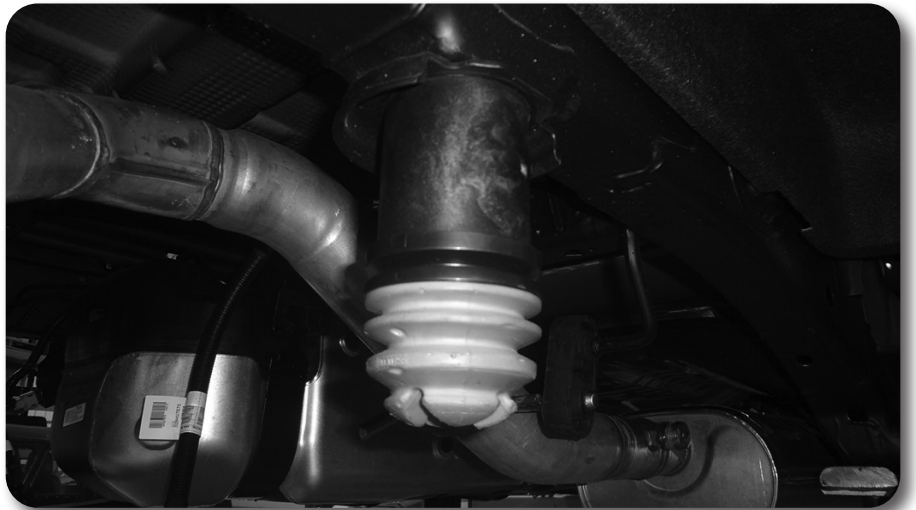

Figure 4

Denali (ARC) & ZR2 / AT4X Models Only

- Denali (ARC) & ZR2 / AT4X Models Only:** Mark the hole to be drilled for the rear shock relocation bracket (Fig. 5). See the template at the end of the instructions for hole drilling placement. For reference the hole spacing is 3" (noted in the template).
- Denali (ARC) & ZR2 / AT4X Models Only:** Drill the hole out to 9/16" through both sides of the rear shock mount. Be sure the holes are concentric with each other since a bolt will be inserted through both holes (Fig. 6).

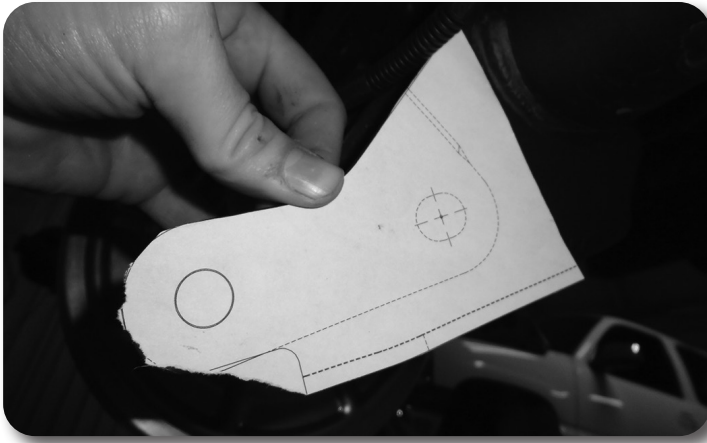

Figure 5



Figure 6

- 13. Denali (ARC) & ZR2 / AT4X Models Only:** Install the provided rear shock relocation bracket with the provided sleeves and 9/16" hardware in the factory shock location and the new hole drilled in the previous step. The bracket should offset the factory bracket to the outside of the vehicle (Fig. 7).

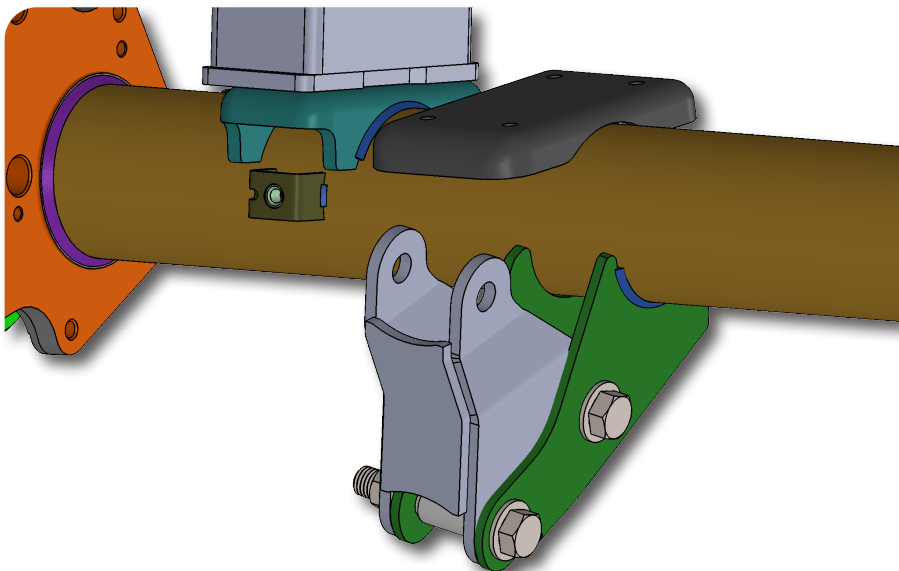

Figure 7

14. **Denali (ARC) & ZR2 / AT4X Models Only:** Reinstall the rear shock in the factory upper mount and upper mount on the rear shock relocation bracket with the factory hardware. Torque all 9/16" and factory hardware to 60 ft-lbs.
15. **Denali (ARC) Models Only:** Reattach the wire harness to the ARC shock. The clips for the wire harness may need to be removed to provide additional slack for the wire harness.

Regular Models

16. **Denali (ARC) & ZR2 / AT4X Models Skip This Step:** Locate the new rear shocks. Install the provided bushings and steel sleeves into the eyes of the shocks. Lubricating the bushings and sleeves with some grease will make installation easier.
17. **Denali (ARC) & ZR2 / AT4X Models Skip This Step:** Install the new shocks with stock hardware and torque upper and lower bolts to 65 ft-lbs. The axle mounting tabs may need to be bent open slightly to allow for clearance of the larger diameter shocks.

All Models

18. Install the (3) provided 5/8" Spacer tubes underneath the brake line / ABS bracket on the top of the rear differential. Use the provided 8mm bolt, washer, and Loctite to attach the brake line / ABS bracket to the differential Fig. 8. Tighten hardware to 11 ft-lbs.

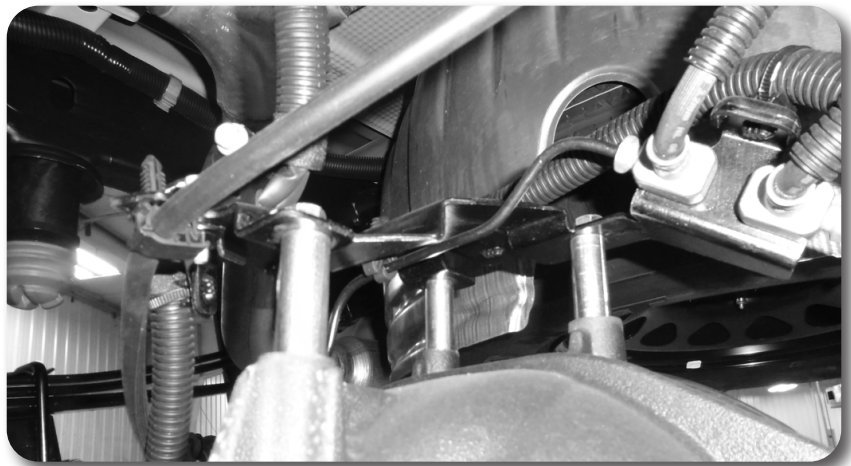

Figure 8

19. Install wheels and tires. Torque lug nuts to 140 ft-lbs. Lower vehicle.
20. Bounce the rear of the vehicle to settle the suspension. Torque leaf spring U-bolts to 100-120 ft-lbs.

Post Installation

21. Double check all fasteners for proper torque.
22. Check all moving parts for clearance.
23. Complete a full radius turning check to ensure that no interference occurs.
24. Align headlights
25. Double check the brake lines for adequate slack at full wheel travel.
26. Complete a vehicle alignment.
27. Check all fasteners after 500 miles
28. At regular maintenance intervals make sure the upper ball joint is greased (3-5,000 miles). The grease fitting can be accessed using a flathead screwdriver and removing the cap from the ball joint cup..

Step 18 Note

Hardware for the brake line / ABS extension is located in bolt pack 852.

Post-Installation Warnings

1. Check all fasteners for proper torque. Check to ensure for adequate clearance between all rotating, mobile, fixed, and heated members. Verify clearance between exhaust and brake lines, fuel lines, fuel tank, floor boards and wiring harness. Check steering gear for clearance. Test and inspect brake system.
2. Perform steering sweep to ensure front brake hoses have adequate slack and do not contact any rotating, mobile or heated members. Inspect rear brake hoses at full extension for adequate slack. Failure to perform hose check/ replacement may result in component failure.
3. Perform head light check and adjustment.
4. Re-torque all fasteners after 500 miles. Always inspect fasteners and components during routine servicing.

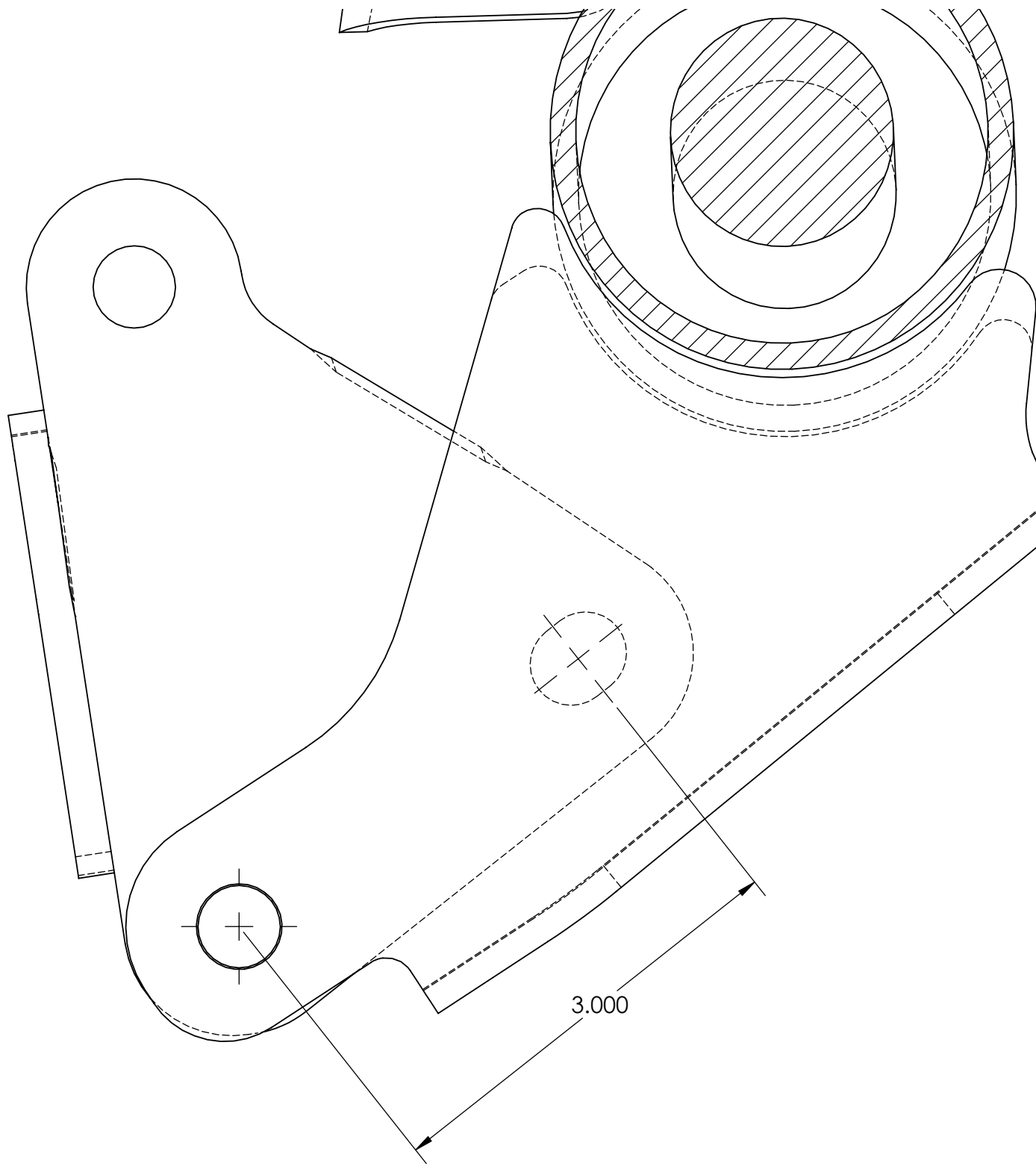

Component	Torque (FT-LBS)
<i>18mm Crossmember Bolts</i>	250
<i>1/2" Differential Hardware</i>	65
<i>9/16" or 14mm Differential Hardware</i>	90
<i>10mm Sway Bar Drop</i>	45
<i>Driveshaft Bolts</i>	48
<i>Differential Skid Plate Hardware</i>	45
<i>Strut Spacer to Strut Nut</i>	30
<i>Hub Bolts</i>	111 <i>Final Pass 30-45 Degrees</i>
<i>Upper Ball Joint Nut</i>	26 <i>Final Pass 60-75 Degrees</i>
<i>Lower Ball Joint Nut</i>	37 <i>Final Pass 125-135 Degrees</i>
<i>CV Axle Nut</i>	185
<i>Strut Spacer to Frame Nuts</i>	40
<i>Strut to Lower Control Arm</i>	37
<i>ABS Wire / Brake Line Brackets / 6mm Knuckle Hardware</i>	92 In-lbs
<i>Brake Caliper Bolt</i>	37 <i>Final Pass 30-45 Degrees</i>
<i>ABS Wire / Brake Line Wire to UCA</i>	92 In-lbs
<i>Sway Bar to Drop Bracket</i>	44
<i>Sway Bar Link to Lower Control Arm</i>	74
<i>Tie Rod to Steering Knuckle</i>	44
<i>ARC Sensor to Frame (Denali Only)</i>	92 In-lbs
<i>Wheels / Tires</i>	140
<i>Control Arm Cam Bolts</i>	133 <i>Final Pass 90-105 Degrees</i>
<i>Upper Control Arm</i>	148
<i>Rear Bump Stop Spacer</i>	37
<i>Shock Spacer (Denali Only)</i>	60
<i>Rear Shocks</i>	118
<i>Rear Brake Line / ABS Spacer</i>	11
<i>U-Bolts</i>	100-120