



## C2503 Installation Instructions 2020-22 Chevy/GM 2500/3500 HD 4WD 5" Suspension System

### Read and understand all instructions and warnings prior to installation of product and operation of vehicle.

Zone Offroad Products recommends this system be installed by a professional technician. In addition to these instructions, professional knowledge of disassembly/ reassembly procedures and post installation checks must be known. Minimum tool requirements include the following: Assorted metric and standard wrenches, hammer, hydraulic floor jack and a set of jack stands. See the "Special Tools Required" section for additional tools needed to complete this installation properly and safely.

#### » PRODUCT SAFETY WARNING

Certain Zone Suspension Products are intended to improve off-road performance. Modifying your vehicle for off-road use may result in the vehicle handling differently than a factory equipped vehicle. Extreme care must be used to prevent loss of control or vehicle rollover. Failure to drive your modified vehicle safely may result in serious injury or death. Zone Offroad Products does not recommend the combined use of suspension lifts, body lifts, or other lifting devices.

You should never operate your modified vehicle under the influence of alcohol or drugs. Always drive your modified vehicle at reduced speeds to ensure your ability to control your vehicle under all driving conditions. Always wear your seat belt.

#### » TECHNICAL SUPPORT

[www.zoneoffroad.com](http://www.zoneoffroad.com) may have additional information about this product including the latest instructions, videos, photos, etc.

Send an e-mail to [tech-zone@ridefox.com](mailto:tech-zone@ridefox.com) detailing your issue for a quick response.

888.998.ZONE Call to speak directly with Zone tech support.

#### » PRE-INSTALLATION NOTES

1. Special literature required: OE Service Manual for model/year of vehicle. Refer to manual for proper disassembly/reassembly procedures of OE and related components.
2. Adhere to recommendations when replacement fasteners, retainers and keepers are called out in the OE manual.
3. Larger rim and tire combinations may increase leverage on suspension, steering, and related components. When selecting combinations larger than OE, consider the additional stress you could be inducing on the OE and related components.
4. Post suspension system vehicles may experience drive line vibrations. Angles may require tuning, slider on shaft may require replacement, shafts may need to be lengthened or trued, and U-joints may need to be replaced.
5. Secure and properly block vehicle prior to installation of Zone Offroad Products. Always wear safety glasses when using power tools.
6. If installation is to be performed without a hoist, Zone Offroad Products recommends rear alterations first.
7. Due to payload options and initial ride height variances, the amount of lift is a base figure. Final ride height dimensions may vary in accordance to original vehicle attitude. Always measure the attitude prior to beginning installation.

#### Difficulty Level

easy 1 2 3 **4** 5 difficult

Estimated installation: 6-8 hours

#### Special Tools Required

Torsion Bar Tool - GM #CH48809

11/16", 17/32", 5/16" Drill Bits

\*Can use Rotary Grinding Tool

36mm Socket

1-1/16" wrench/socket

1-1/8" socket

Reciprocating Saw

T30 Torx Bit

#### Tire/Wheel Fitment

37x12.50 on 20x9, 22x9 w/5-5.5" BS

35x12.50 on 20x10, 22x10 w/ 5-5.5" BS

35x12.50 on 20x9, 22x9 w/4.5 - Stock BS

35x12.50 on 17 x 9/18 x 9 w/4.625" BS  
Max

## Front Kit Contents

### C2500 Front Box Kit

Qty	Part
1	Steering Knuckle - DRV
2	Front Bump Stop Extension
2	Front Sway Bar Links
2	0.75" x 1.65" Sleeve - Sway Bar Links
2	0.75" x 1.25" Sleeve - Sway Bar Links
2	Offset Poly Spacer - Sway Bar Links
1	Bolt Pack - Sway Bar Links
1	Bolt Pack - Steering Knuckle

### C2501 Front Box Kit

Qty	Part
1	Steering Knuckle - PASS
2	Rear Bump Stop Extension
4	Bump Stop Nut Plate
3	3/8"-16 Rivet Nut - Thin Material
3	3/8"-16 Rivet Nut - Thick Material
1	Bolt Pack - Bump Stop
1	Bolt Pack - Steering Knuckle

### C2502 Front Box Kit

Qty	Part
1	Front Cross Member
2	Torsion Bar Drop Brackets
1	Brake Line - DRV
1	Brake Line - PASS
4	Brake Line Crush Washers
2	Brake Line Clips
1	Bolt Pack - Torsion Bar Brackets
1	Bolt Pack - Steering Knuckles

**\*Important\* Verify you have all of the kit components before beginning installation.**

1	Bolt Pack - Cross Members
2	Zone Offroad Badges - Torsion Bar Drop Brackets
6	1/8" Rivets

### C2503 Front Box Kit

Qty	Part
1	Rear Cross Member
1	Differential Drop - DRV
1	Differential Drop - PASS
1	Differential Drop - Center
1	0.875" x 2.60" Sleeve - Differential Drop Center
2	Bushings - Differential Drop Center
1	Thread Locker
3	Zip Ties
1	Bolt Pack - Differential Drop

### C2504 Front Box Kit

Qty	Part
1	Skid Plate

### C2459 / C2458 Rear Box Kit

Qty	Part
1	Rear 4.5" Tapered Block - DRV
1	Rear 4.5" Tapered Block - PASS
4	3/4" x 15-1/2" Square U-Bolt (C2459)
4	3/4" x 18" Square U-Bolt (C2458)
8	3/4" Serrated Edge Nuts
4	Zip Ties
1	Rear Brake Line Bracket
1	ABS Line Bracket
1	Bolt Pack - Brake and ABS Lines



## PRE-INSTALLATION NOTES

1. Do not install this suspension system in conjunction with any type of torsion bar lift keys.
2. Stock 20" x 8.5" wheels with factory 6.18" backspacing MAY fit with a max tire size of 37 x 12.50 on certain tire sidewall profiles due to clearance to the steering knuckle. A minimum ¼" wheel spacer may be required due to tire side wall profile variations. A wider tire will cause clearance issues with the steering knuckle. Stock 17" and 18" wheels will not fit back on the vehicle once this suspension system is installed
3. Some minor trimming will be required with certain wheel/tire combination. This is normal with most aftermarket tire/wheel fitment on Chevy/GM trucks. Trimming will normally included the bottom edge of the inner fender shrouds and/or lower corner of front bumper valance. As a rule of thumb, deeper backspacing and shorter/narrower tires will reduce/eliminate trimming required. Further trimming tips are included at the end of this instruction sheet.
4. Front ride height can be adjusted after installation. See "Set Front Ride Height" section at the end of the instruction sheet. These guidelines we help to properly set the ride height higher or lower then the intended 5" of lift.

## INSTALLATION INSTRUCTIONS

### Front Installation

1. Park the vehicle on a flat, clean surface and block the rear wheels for safety.
2. Raise the front of the vehicle and support with jack stands under the frame rails.
3. Remove the wheels.
4. Measure and record the length of the exposed thread on the torsion bar adjuster bolts **Figure 1**. Record the lengths here for use later during the installation

DRV Side: \_\_\_\_\_ PASS Side: \_\_\_\_\_



Figure 1

5. Unload the torsion bars but do not remove. Remove and save adjuster bolt/retainer block. Torsion bars are under extreme pressure. A proper torsion bar tool is necessary to unload the bars. A tool designed specifically for GM torsion bars is required.
6. Mark the unloaded torsion bars to indicate DRV side and PASS side. Also mark the bars to indicate front versus rear.

### Important—measure before starting!

Measure from the center of the wheel up to the bottom edge of the wheel opening

LF \_\_\_\_\_ RF \_\_\_\_\_

LR \_\_\_\_\_ RR \_\_\_\_\_

7. Remove the torsion bar adjuster key by pushing the torsion bar forward to allow the key to drop free. On some vehicles this will require using a hammer/punch or air hammer. Access the end of the torsion bar through the hole in the back of the torsion bar cross member and drive forward. Leave the torsion bars in the lower control arms.
8. Remove the two bolts that attach the torsion bar cross member to the frame rails **Figure 2A**. Remove the torsion bar cross member from the vehicle. Save bolts and cross member.



Figure 2

9. Remove the torsion bars by pulling them rearward out of the lower control arms. Set the torsion bars aside.
10. If equipped, remove the four bolts mounting the factory belly pan to the frame and the two bolts mounting the front skid to the cross member **Figure 3**. These will not be reused.

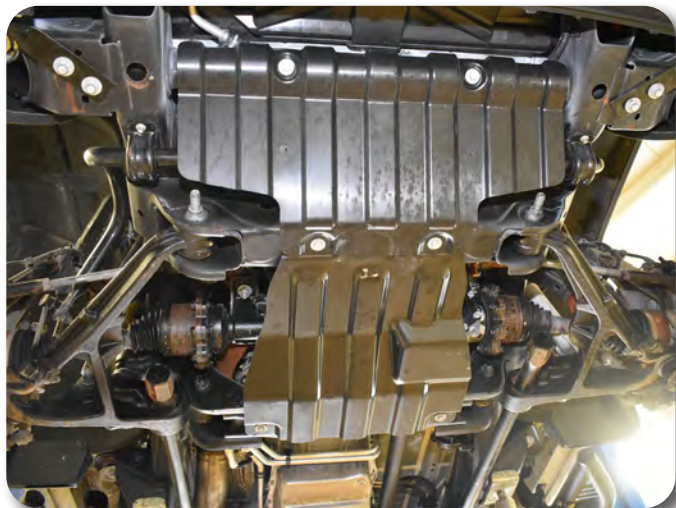

Figure 3

11. Disconnect the sway bar end links from the sway bar and the lower control arms **Figure 4**. Discard the link assemblies.
12. Disconnect the tie rod ends from the steering knuckles **Figure 5**. Remove the tie rod end nuts and save. Strike the knuckle near the tie rod end to dislodge the tie rod end taper **Figure 5**. Remove the tie rod ends from the knuckles.



Figure 4



Figure 5

13. Disconnect the ABS / brake wire from the connector at the frame **Figure 6**. Remove the wire from the plastic retainers on the frame/steering knuckle and brake line bracket on the steering knuckle **Figure 7**. Disconnect the ABS Sensor from the steering knuckle **Figure 8**.



Figure 6



Figure 7



Figure 8

14. Remove the four bolts mounting the brake caliper assembly to the steering knuckle and hang the caliper out of the way **Figure 9**. Do not hang the caliper by the brake hose. Save mounting bolts.

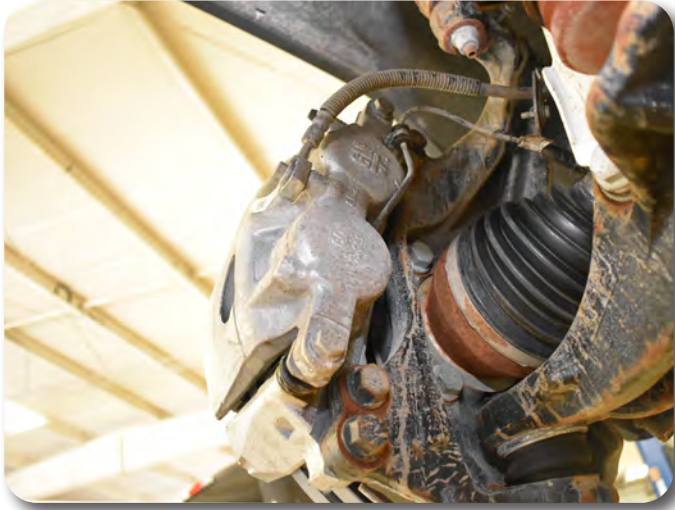

Figure 9

15. Carefully remove the hub dust cover. Save cover **Figure 10**.



Figure 10

#### **Step 15 Note**

Carefully work the cover loose with a small chisel.

16. Remove the rotor retaining bolt using a T30 torx bit **Figure 11**. Remove the brake rotor and set aside. Save retaining bolt.
17. Remove the CV axle nut and washer **Figure 11**. Save hardware.

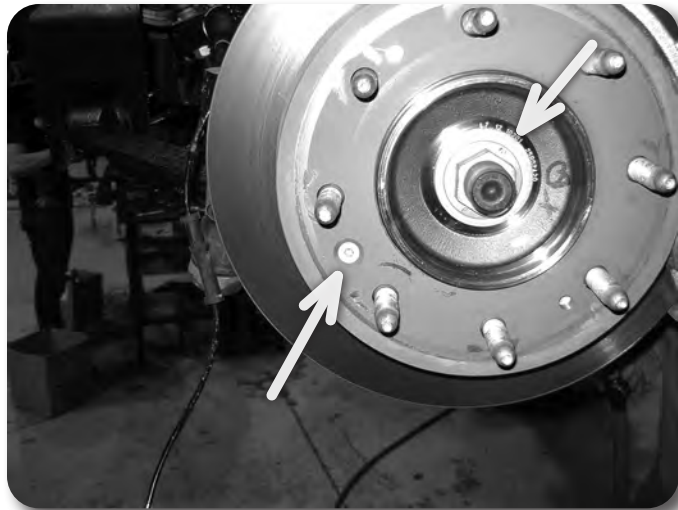

Figure 11

18. Locate and remove the four hub bearing assembly bolts **Figure 12**. The bolts are accessed from the back side of the steering knuckle. Remove the hub bearing assembly and dust shield from the steering knuckle. Save for later installation.

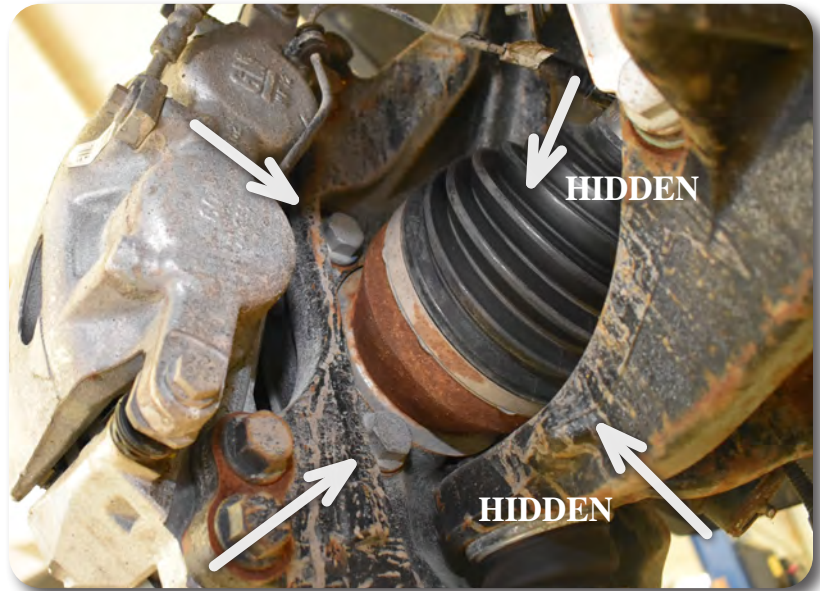

Figure 12

19. Remove the upper and lower ball joint nuts **Figure 11**. Reinstall the nuts a couple of turns by hand. Strike the knuckle near the ball joints to release the taper. Remove the nuts and remove the steering knuckle from the vehicle. Save nuts and the o-rings. Take care not to strike the ball joint.





Figure 13

20. Remove the CV axle flange bolts at the differential **Figure 14**. There are 8 bolts per side. Remove the CV shafts from the vehicle and set aside. Save bolts.



Figure 14

21. Disconnect the shocks from the frame **Figure 15A** and lower control arm **Figure 15B**. Remove shocks. Save the upper and lower shock mount hardware.



Figure 15A



Figure 15B

22. Remove the front and rear lower control arm bolts and remove the control arms from the vehicle Figure 16 Save the control arms and mounting hardware.

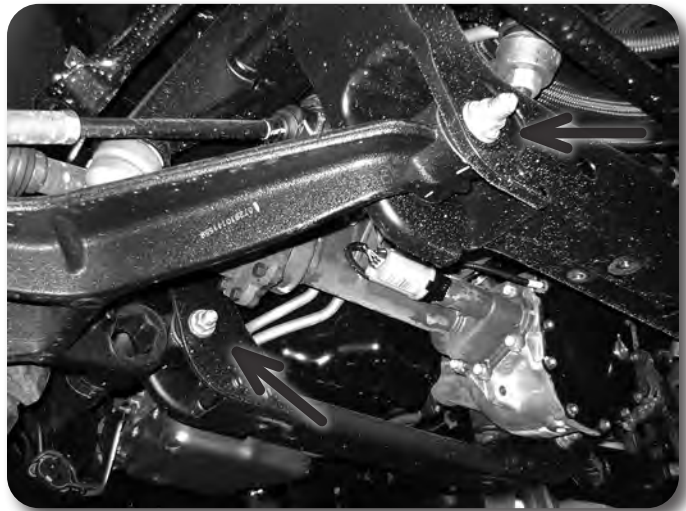

Figure 16

23. There are two factory bump stops per side. Remove rubber bump stop from the frame mounts on each side. They can be removed with a pair of channel-lock pliers or by striking them with a rubber mallet. Save rubber bump stops.
24. Make an alignment mark on the front driveshaft and front differential input yoke. Remove the four bolts/clamps from the yoke and remove the front driveshaft from the differential **Figure 17**. Save the driveshaft hardware.



Figure 17

25. Remove the four bolts mounting the rear cross member to the rear lower control arm pockets **Figure 18**. Remove the cross member from the vehicle. The cross member and hardware will not be reused.



Figure 18

26. Disconnect the electrical connector from the front differential actuator **Figure 19A**. Remove the wire from the three plastic wire retainers along the top of the differential.
27. Disconnect the axle breather tube from the top of the driver's side of the differential **Figure 19B**.



Figure 19A



Figure 19B

28. Loosen but do not remove all of the front differential mounting bolts/nuts. There are two nuts on the passenger's side (Figure 20A) and three bolts on the driver's side (Figure 20B - two mount from the bottom up and one from the top down). Remove the rear-most bolt mounting from the top.



Figure 20A

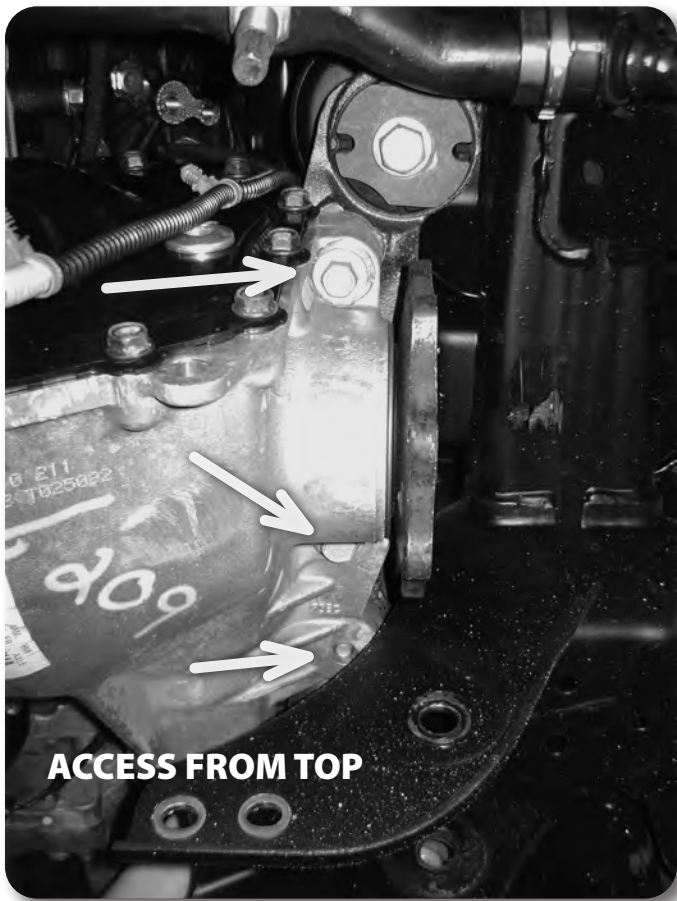

Figure 20B

29. Support the front differential with an appropriate jack. Remove the differential mounting hardware and lower the differential from the vehicle and set aside. Save hardware.
30. The lower rear driver's side control arm pocket must be trimmed to provide clearance for the front differential. On the front face measure from the center of the control arm mounting hole inward 1-1/4" and mark. **Figure 21A** On the back face measure from the center of the control arm mounting hole inward 2-1/2" and mark. **Figure 21B** Make vertical cut lines at the marks on the front and back

faces. Along the top, connect the front and back cut lines with a diagonal cut line. Figure 21C.

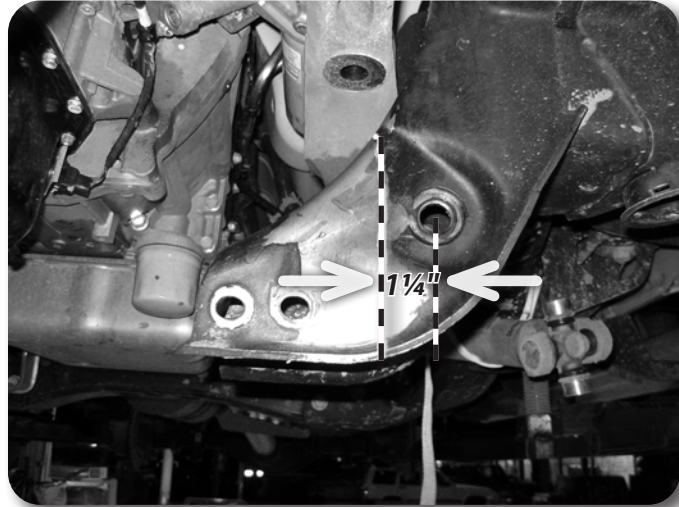

Figure 21A

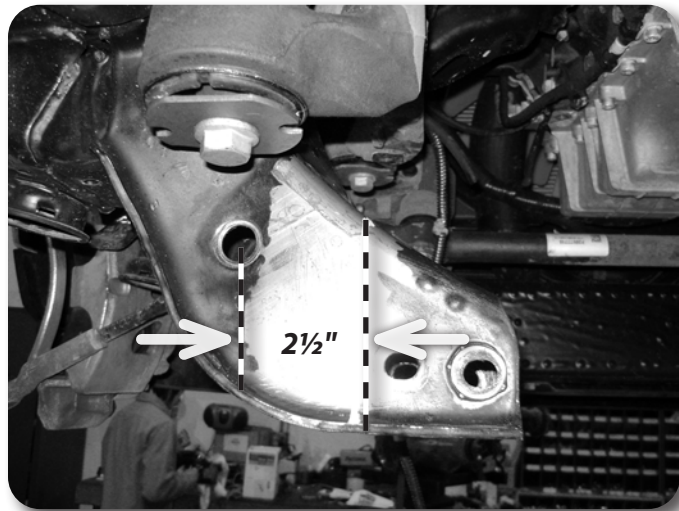

Figure 21B



Figure 21C

31. Using a reciprocating saw (recommended), cut-off wheel, or plasma cutter, cut the pocket along cut lines. Remove any burrs or rough edges and paint any bare metal to prevent corrosion.
32. Locate all of the provided rivet nuts and bump stop bolt pack. There are 3 of each of the 2 different rivet nuts sizes are provided, one set is longer than the other. Sort the rivet nuts by size. **Figure 22** Set up the rivet nut installation tools. The 3/8" tool consists of a 3/8" x 1-1/2" bolt, 7/16" hex nut and 3/8" star washer.



Figure 22

33. Four holes need to be slightly clearanced on the factory bump stop mounts to accepted the rivet nuts. The 3/8" rivet nuts need the holes drilled out to 17/32". If the necessary bits are not available, a rotary grinding tool can be used to enlarge the holes to the proper size. Take care not to open the holes too much. Drill out the holes shown in **Figure 23A** (front mount) and **Figure 23B** (rear mount).

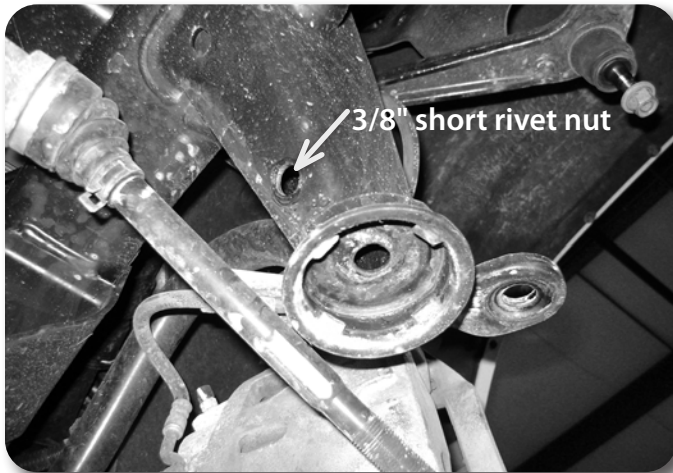

Figure 23A

**Step 32 Note**  
All bump stop mounting hardware is located in hardware pack #871

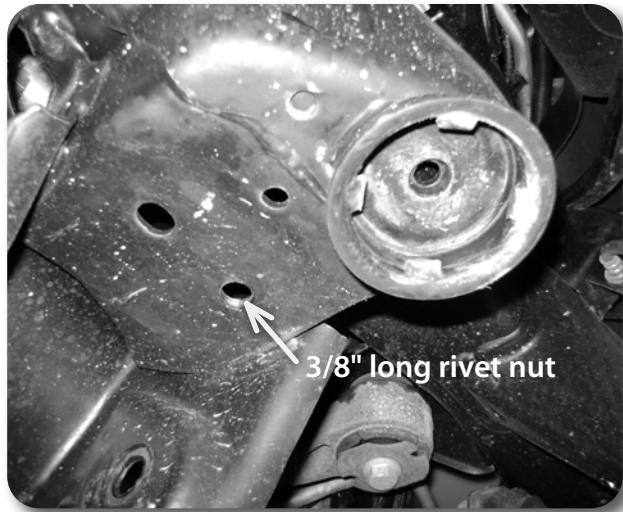

Figure 23B

34. Install the rivet nuts. Thread the appropriate rivet nut on the pre-assembled tool. The longer 3/8" rivet nut will be installed in the rear bump stop mount. Insert the rivet nuts into the holes. Hold the jam nut with a wrench and tighten the bolt to collapse the rivet nut in the hole. **Figure 24A** Be sure to hold the rivet nut tight and flush in the hole. Take care not to over tighten. The 3/8" rivet nut can be tightened to approximately 40-45ft-lbs. Reuse the tool to install all four rivet nuts. **Figure 24B** For detailed rivet nut installation instructions see the end of this instruction sheet.



Figure 24A



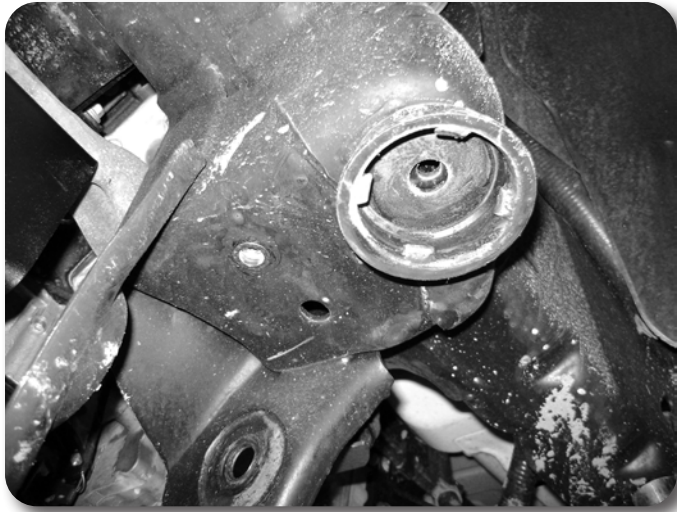

Figure 24B

35. With all the rivet nuts installed, locate the provided front bump stop brackets and two nut plates. Install the nut plates in the factory bump stop cups so the tabs point down and lock in place against the tabs in the cup. Attach the front brackets to the factory bump stop mount with the nut tab using a 3/8" x 1" Bolt, lock washer, and flat washer, Snug hardware. Fasten the back of the mount with a 3/8" x 1-1/4" bolt, flat washer and lock washer. Torque the 3/8" hardware to 30 ft-lbs. Figure 25B

**Step 36-37 Note**  
All bump stop mounting hardware is located in hardware pack #871

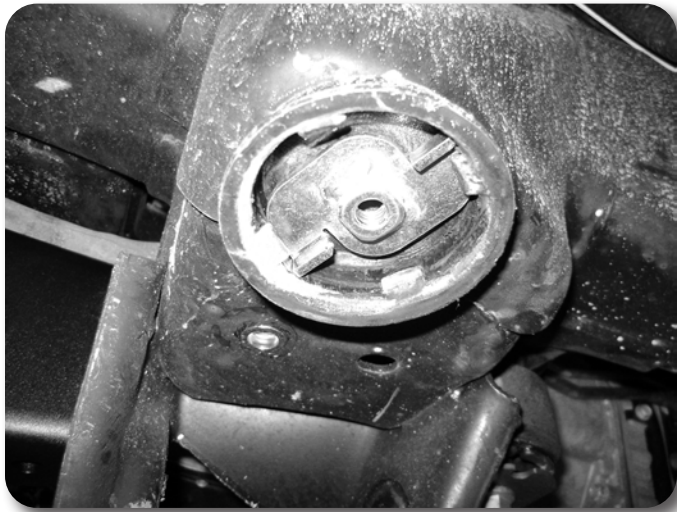

Figure 25A

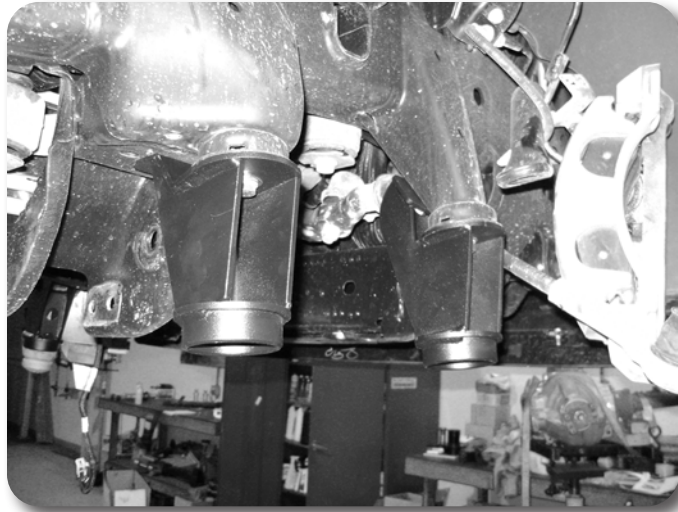

Figure 25B

36. Locate the rear bump stop brackets and two nut plates. Install the nut plates in the factory bump stop cups so the tabs point down and lock in place against the tabs in the cup. **Figure 25B** Attach the bump stop bracket to the factory mount with a 3/8" x 1" bolt, flat washer and lock washer into the nut plate. Snug hardware. Fasten the back tab of the bracket to the rivet nut with a 3/8" x 1-1/4" bolt, flat and lock washer. Torque 3/8" hardware to 30 ft-lbs.
37. Install the factory bump stops into the new mounts. Place the bump stops in the new cups at an angle and twist them into the cups. **Figure 26**



Figure 26

38. Install the provided large bushings and 0.875" OD x 2.620" long sleeve into the eye of the new center differential bracket **Figure 27**.



Figure 27

39. Locate the 4 housing bolts to be removed. Remove the four bolts, place the bracket in position and fasten with new 10mm x 40mm bolt and washers. The bracket gusset will be toward the bottom of the differential Figure 28. Use thread locket on the bolt threads and torque to 59 ft-lbs.

### Step 39 Note

Differential hardware is located in bolt pack #586



Figure 28

40. Locate the new passenger's side differential bracket. Bracket has a single center gusset. Install the bracket on the existing studs on the passenger's side factory bracket. Fasten with the original nuts and washers. When installed the open side of the bracket will face inward and the bracket will taper down as it goes to the rear Figure 29. Torque nuts to 74 ft-lbs.

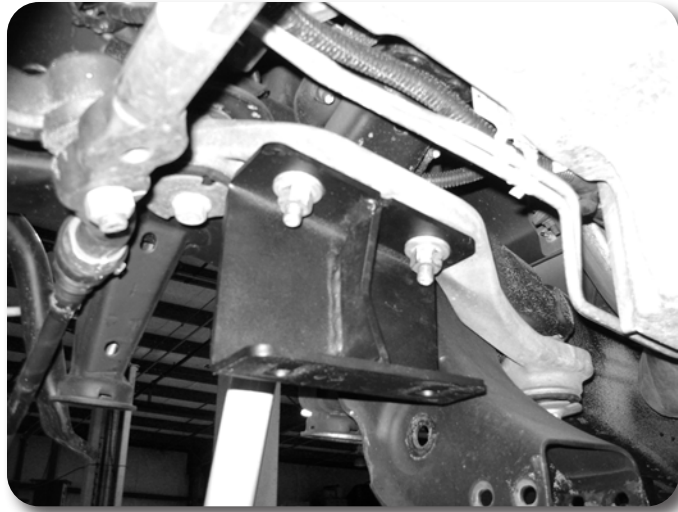

Figure 29

### Step 41 - 42 Note

Differential hardware is located in bolt pack #586

41. Locate the new driver's side differential bracket. Bracket has two center gussets. Install the bracket to the 2 front original differential mounting holes with the provided 12mm-1.75 x 40mm bolts and 1/2" SAE washers, applying thread locker to the threads before installation. When installed the open side of the bracket will face inward and the bracket will taper down as it goes to the rear **Figure 30**. Torque bolts to 65 ft-lbs.

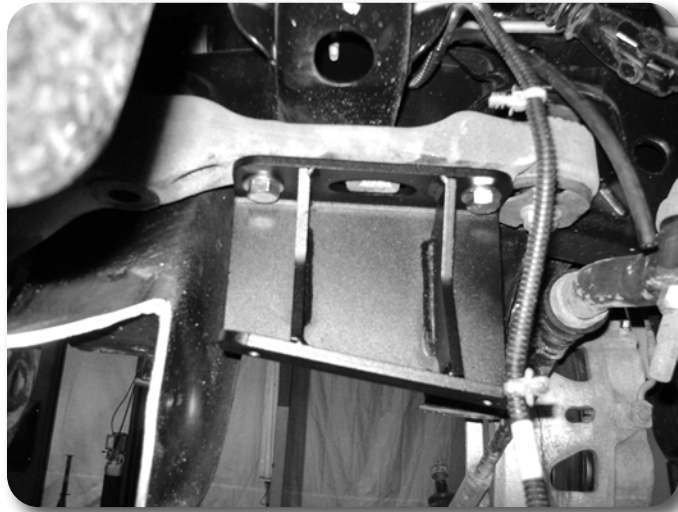

Figure 30

42. Using an appropriate jack, raise the differential up into the vehicle. Align the differential mounting holes to the new driver's and passenger's side differential brackets. Fasten to the driver's side mount with 1/2" x 3-1/2" bolts, nuts and 1/2" SAE flat washers. Fasten the passenger's side 1/2" x 1-1/2" bolts, nuts and heavy 1/2" (large OD) washers. Snug up hardware, but do not tighten. **Figure 31**



Figure 31

### Step 42 Note

Check to ensure the differential clears the rear cross member / frame where the frame was trimmed. It may be necessary to clearance the differential housing at this point.

43. Locate the new rear cross member. Install the cross member in the rear lower control arm pockets with the factory control arm bolts/nuts. Run the bolts from rear to front. The center differential bracket will fit into the mount tabs on the cross member. Fasten the differential mount to the cross member with a 9/16" x 4" bolt, nut and 9/16" SAE washers. Leave hardware loose. **Figure 32**

*Note: OE front differentials have varied in design with and without ribs which may interfere with the replacement rear crossmember, The ribs on the differential may need to be ground down to clear the rear crossmember. See Figure 32B.*



Figure 32A

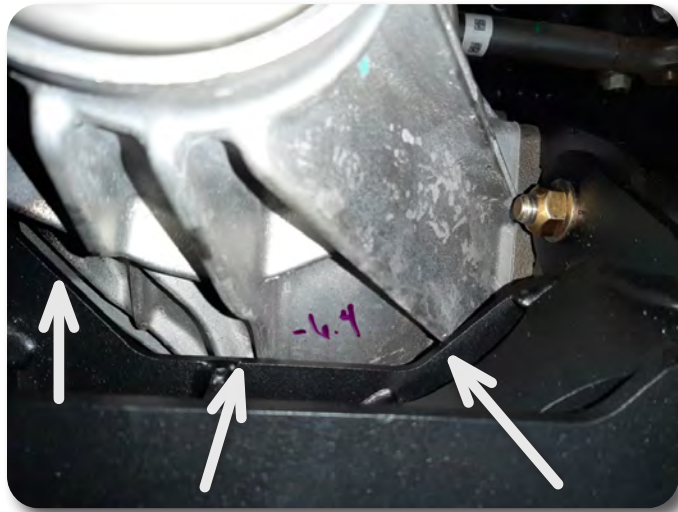

Figure 32B

44. With the differential and rear cross member installed, tighten all the differential mount hardware. Torque the (4) 1/2" bolts to 65 ft-lbs and (1) 9/16" bolt to 95 ft-lbs.
45. Reconnect the front driveshaft to the front differential with the factory clamps and bolts. Torque hardware to 25 ft-lbs.
46. Reconnect the front differential actuator wire. Reattach the wire harness to the housing. Use the provided zip ties where needed. Pull down on the differential breather hose to gain slack and reconnect to the top of the differential.
47. Locate the new front cross member. Install the cross member in the front lower control arm pockets and fasten with the original control arm bolts/nuts. **Figure 33** Run the bolt from front to rear. Leave hardware loose.



Figure 33

48. Install the factory control arms in the cross members. Fasten the control arms with the provided 18mm x 120mm (front) and 18mm x 140mm (rear) bolts, nuts and 3/4" SAE flat washers. Run the front bolts front-to-rear and the rear bolts rear-to-front. **Figure 34** Leave hardware loose. These bolts will be torque with the weight of the vehicle on the suspension.

### Step 48 Note

Control arm hardware is located in hardware pack #585.



Figure 34

49. Locate the new differential skid plate. Position the skid plate so that it aligns to the thread holes on the bottom of the front and rear cross members **Figure 35**. Fasten the skid plate with 1/2" x 1-1/4" bolts and 1/2" SAE washers. Use Loctite on the bolt threads and torque bolts to 60 ft-lbs.

### Step 49 Note

Differential skid plate hardware is located in hardware pack #586

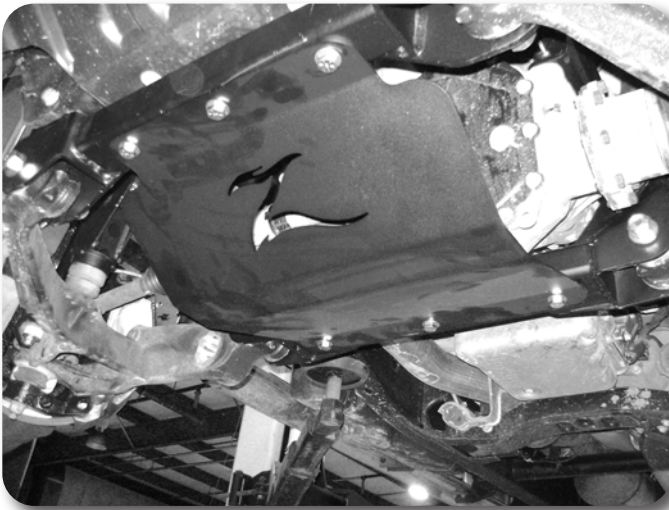

Figure 35

50. After all the skid plate hardware is tight, go back and torque the 4 factory lower control arm pocket bolts (mounting the new cross members) to 250 ft-lbs.
51. Locate the new steering knuckles and identify the driver's and passenger's side. Install the appropriate knuckle on the lower control arm and fasten with the original lower ball joint nut. Swing the knuckle up and attach to the upper ball joint with the original nut. Torque the upper ball joint nut to 37 ft-lbs and the lower ball joint nut to 74 ft-lbs **Figure 36**.



Figure 36

52. Locate the hub o-rings in the factory steering knuckle hub bores. Carefully remove the o-rings Figure 37 and install into the new steering knuckles.



Figure 37

### Step 54 Note

The ABS sensor cannot be installed if the hub / brake shield assembly is already installed.

53. Locate the factory driver's and passenger's brake dust shields. They need to be modified to provided adequate brake caliper clearance. Make a cut line by following the straight edge on the caliper side of the shield all the way to the bottom edge of the shield. Figure 38 Cut the shield along the line.





Figure 38

54. Install the ABS sensor into the steering knuckle using the factory bolt and thread locker Figure 39. Torque to 10 ft-lbs.



Figure 39

55. Install the hub assembly, O-rings, and dust shield into the appropriate steering knuckle. Figure 40 Fasten the hub to the knuckle with the factory bolts. Apply thread locker to the threads and torque the bolts to 125 ft-lbs.

### Step 55 Note

Make sure both O-rings are installed into the steering knuckle when the hub is installed..



Figure 40

### Step 56 Note

Brake line hardware is located in hardware pack #877.

56. Run the ABS line around the back side of the tie rod of the steering knuckle and up to the wire connector on the frame. Reconnect the wire and reattach it to the original place on the frame. Attach the ABS line to the back side of the knuckle near the tie rod end using a wire clamp and a 1/4" x 5/8" bolt, flat washer and lock washer Figure 41

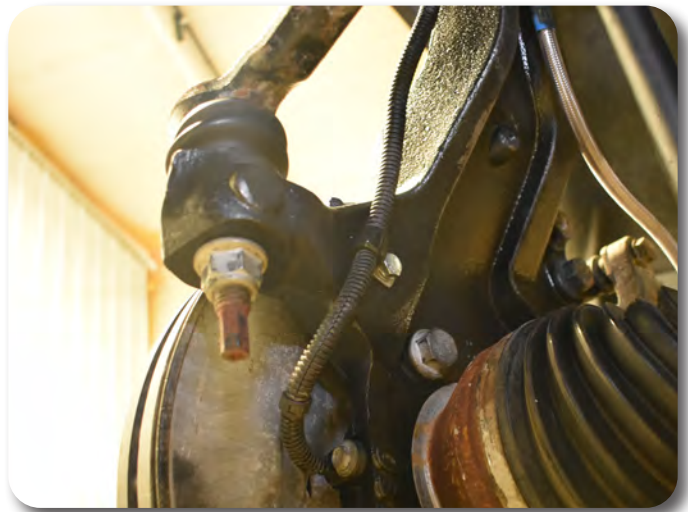

Figure 41

57. Locate the factory CV axle shafts. Install the CV axle into the hub assembly Figure 42 and then onto the differential output flange. Align the differential flange holes and fasten with the factory bolts. Apply thread lockers to the threads and torque to 58 ft-lbs.



Figure 42

### Step 58 Note

The CV axle nut may need to be torqued on the ground.

58. Install the original CV axle nut and washer and torque to 155 ft-lbs. Reinstall the hub dust cap.
59. Install the brake rotor on the hub by aligning the tapered retainer bolt hole in the rotor with the threaded hole in the hub flange. Fasten the rotor to the hub with the original retainer bolt and tighten securely with a T30 torx bit to 106in-lbs.
60. Locate the factory brake line junction at the frame where the hard line and rubber line meet. Figure 43A Using a 13mm line wrench disconnect the hard line from the rubber line. Remove the retaining clip and pull the line from the frame bracket. Figure 43B Place a bucket, etc under the hard line to catch any brake fluid drips.



Figure 43A

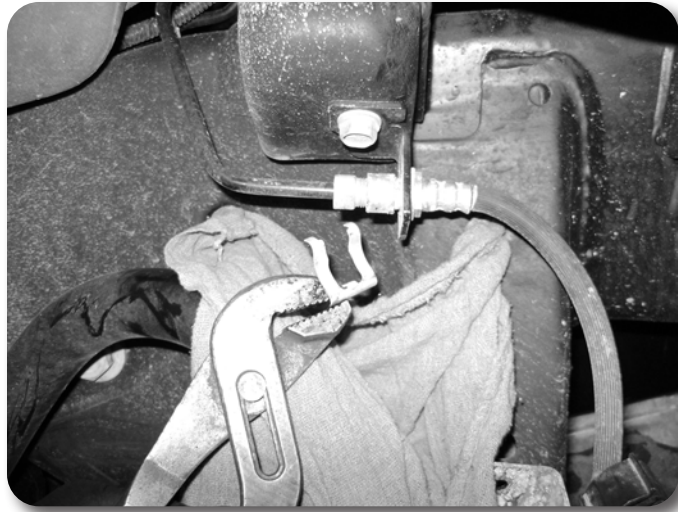

Figure 43B

61. With the brake lines free, install the brake calipers on the knuckles with the original bolts. Apply thread locker to the bolt threads and torque the bolts to 221 ft-lbs.
62. Locate the new provided stainless steel brake lines. The lines are driver's and passenger's side specific. The caliper end has a offset angle. When install the hard line at the caliper should point slightly inward toward the steering knuckle. Identify the appropriate lines. Figure 44 - Drv's Side Shown

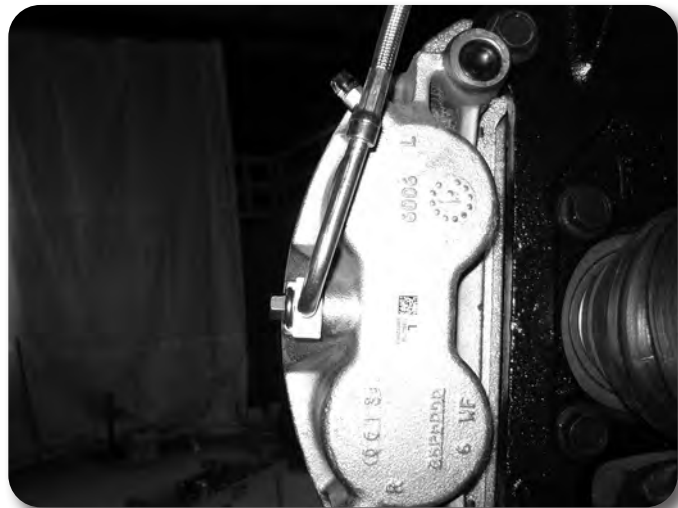

Figure 44

63. Remove the factory brake line from the caliper. Be sure to remove the factory crush washers as well. Place a new provided crush washer on each face of the new brake line and install on the caliper with the factory banjo bolt. Torque the bolt to 25 ft-lbs.
64. Run the new brake line up to the factory frame mount bracket. Feed the end of the line through the bracket and fasten to the factory hard line. Using a 13mm line wrench on the hard line fitting and 11/16" wrench on the new line, tighten the fitting securely. Secure the line to the factory bracket with the original brake line clip or the provided new one (5188). Figure 45 When tightening be sure the brake line does not twist. It should run in a smooth arc from the caliper.

### Step 65 Note

The brake sensor wire is only on the driver's side



Figure 45

### Step 65 Note

Brake line hardware is located in bolt pack #877.

65. There are two threaded holes near the top of the steering knuckle neck on the back side. Using a provided wire clamp, 1/4" x 5/8" bolt, flat washer and lock washer loosely fasten the brake line to the lower threaded hole on the steering knuckle. Using the same fastener combination, attach the ABS line and brake sensor wire to the upper threaded hole. Pull the slack out of the line between the clamp and the caliper to provide as much loose line as possible above the clamp then tighten to lock it in place. The hardware will be tightened once the line slack is set. Figure 46A



Figure 46A

66. On the back middle of the steering knuckle there is a small threaded hole. Using a wire clamp, fasten the brake line to the knuckle with a 1/4" x 5/8" bolt and hardware (BP #877). **Figure 46B** Pull the slack out of the line between the caliper and the first clamp and tighten the hardware for the clamp to 10 ft-lbs to lock it in place. Continue to pull the slack above the top clamp on the knuckle to have as much loose brake line slack as possible for the suspension motion then tighten the top clamp hardware to 10 ft-lbs to lock it in place.



Figure 46B

### Step 67 Note

Sway bar link hardware is located in hardware pack #870.

67. Locate the new front sway bar links. Install the two sleeves into the bushings of the sway links. One sleeve will be longer than the other one. Install the poly offset spacer onto the longer sleeve. Install the longer sleeve with the poly offset spacer sandwiched between the bushing and control arm to the lower control arm on the INSIDE of the control arm using the provided 12mm x 80mm bolt, 7/16" USS Flat washer, and 12mm prevailing torque nut **Figure 47**.



Figure 47

68. Attach the upper bushing and sleeve to the sway bar using the provided 12mm x 65mm bolt, 7/16" USS Flat washer, and 12mm prevailing torque nut. Tighten the 12mm sway bar hardware to 60 ft-lbs.
69. Locate the new provided Zone Offroad front shocks. Install the bushing and bar pin into the upper eye of the shock. Make sure the bar pin is centered in the bushing. Fasten upper bar pin to frame mount with the 1/2" bolts and a washer and nut on the top. Torque the 1/2" bolts to 50 ft-lbs. Fasten the shock to the factory lower control arm mount with the original hardware. Leave lower shock hardware loose till the vehicle is on the ground.
70. Attach the tie rod ends to the knuckles. The tie rod end will mount from the top down. Fasten with the original nuts and torque to 44 ft-lbs.
71. Locate the factory torsion bars and install them into the lower control arms. Be sure to install the bars on the correct side of the vehicle and in the correct orientation (front vs rear). Slide the bars forward in the arms about 6".
72. Locate the four small holes (two per side) and the bottom tab of the factory torsion bar cross member. **Figure 48** Drill the holes out to 5/16".

**Step 69 Note**  
 The FOX shock hardware is included in the FOX shock box in bolt pack #347

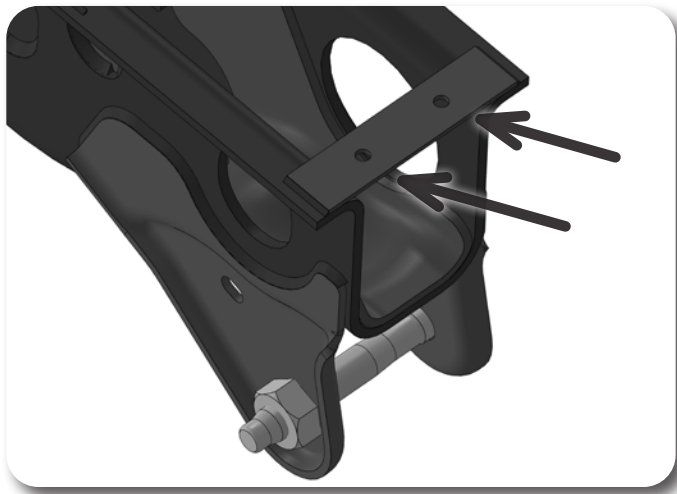

Figure 48

73. Install the provided torsion bar cross member bracket on the torsion bar cross member. Fasten with the factory bolt and the provided 1/4" x 1" bolt, nut and washers through the bottom of the new bracket into the drilled-out holes in the cross member. **Figure 49** Torque the 1/4" hardware to 12 ft-lbs and factory hardware to 90 ft-lbs.

**Step 71-73 Note**  
 Torsion bar bracket hardware is located in hardware pack #872  
  
 The heat shield will need to be folded back on the passenger side of the torsion bar cross member

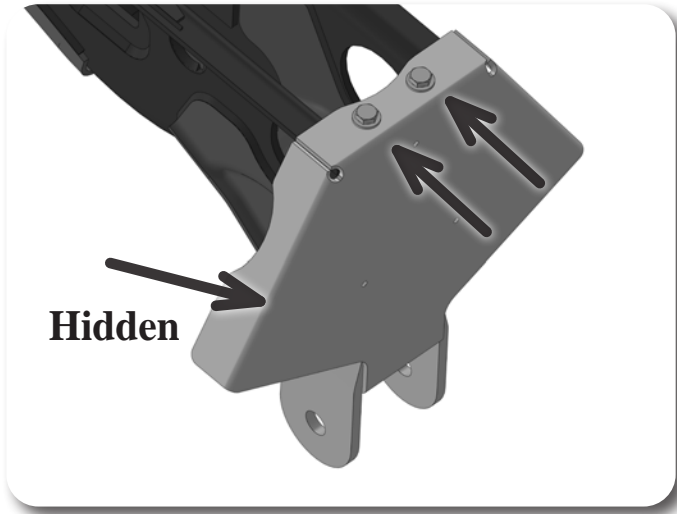

Figure 49

## Step 74 Note

The Badge and Rivets are located in Bag Kit B1328.

74. Rivet on the Zone Offroad Badge to the torsion bar drop bracket with the provided 1/8" rivets. Figure 50

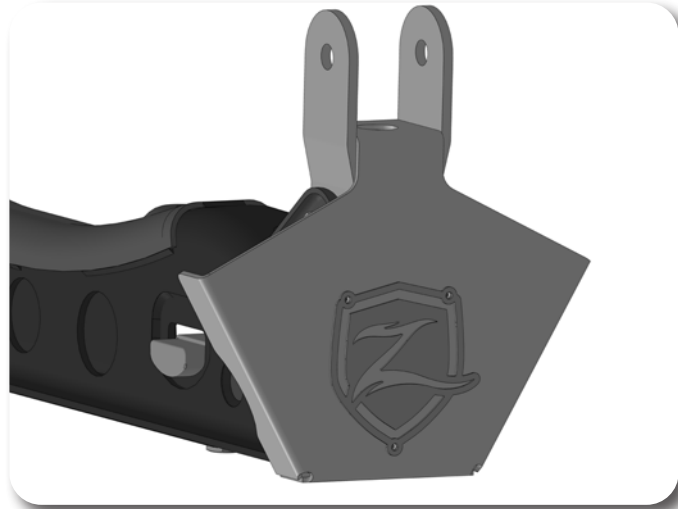

Figure 50

75. Install the modified torsion bar cross member to the original frame mounts. Be sure it is oriented properly (larger torsion bar holes to the front). Fasten to the factory frame mounts with 9/16" x 4" bolts, nuts and washers. Figure 51 Torque bolts to 90 ft-lbs.

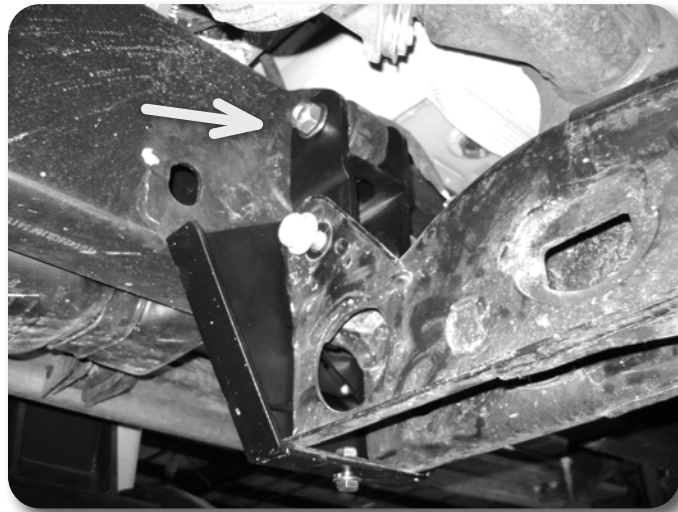

Figure 51

76. Slide the torsion bars back to the cross member and install the factory torsion adjuster keys.
77. Load the torsion bars with the appropriate tool. Reinstall the adjuster bolt/retaining plate assembly. Reset the torsion bar adjuster bolt position to the original height measurement taken at the beginning of the installation. This adjustment will be checked/changed at the end of the installation.
78. Install the front wheels. Torque the lug nuts to 140 ft-lbs. Lower the vehicle to the ground.
79. Bounce the front end to settle the suspension.
80. Torque the lower control arm bolts (4) to 250 ft-lbs.
81. Torque the lower shock bolts (2) to 90 ft-lbs.
82. Check all front hardware for proper torque.



83. Properly bleed the entire brake system. Top off fluid. Check all brake lines for proper clearances. Adjust as necessary.
84. Check tire/wheel clearance with the fenders/bumper as well as with the steering knuckle. It is not uncommon to trim the lower plastic valance of the bumper and inner fender shroud slightly to add proper tire clearance while turning.

## Rear Installation

1. Block the front wheels for safety. Raise the rear of the vehicle and support with jack stands under the frame rails, just ahead of the front leaf spring hangers.
2. Remove the wheels.
3. Raise rear of vehicle and support frame with jack stands.
4. Support the rear axle with a hydraulic jack.
5. Disconnect the two nuts attaching the brake lines to the rear differential housing. Save hardware, it will be reinstalled later. Figure 52

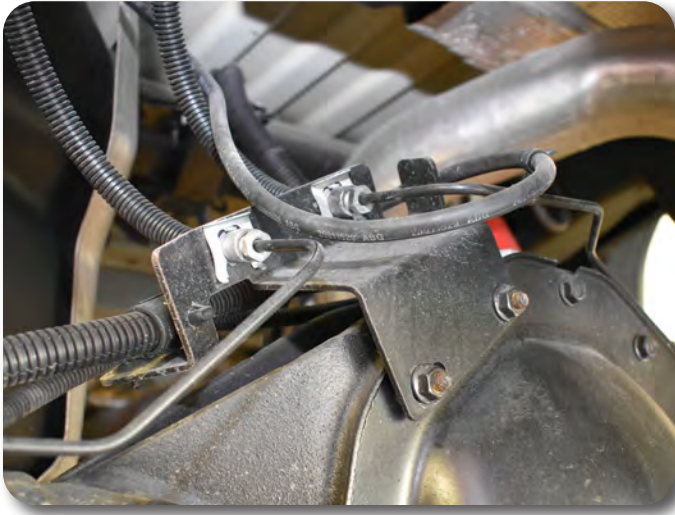

Figure 52

6. Remove the ABS mount from the top of the differential housing. Save hardware, it will be reinstalled later. Figure 53



Figure 53

7. Remove the rear shocks. Save hardware.

8. With the axle well supported, remove the passenger's side u-bolts and lower u-bolt plate. Loosen, but do not remove the u-bolt hardware on the driver's side. This will allow the axle to move more easily and aid in installation.
9. Install the new blocks between the axle and the leaf spring. Position the block so that the bump stop wing faces inward, and the small side of the block faces forward. Align the pins/holes and raise the axle to seat the assembly. The pin will go into the **REAR** most hole on the block. Install the new provided u-bolts with the factory u-bolt plate. **Figure 54A & B** Fasten with the provided locking flange nuts. Snug hardware. Final torque will be down with the vehicle on the ground.

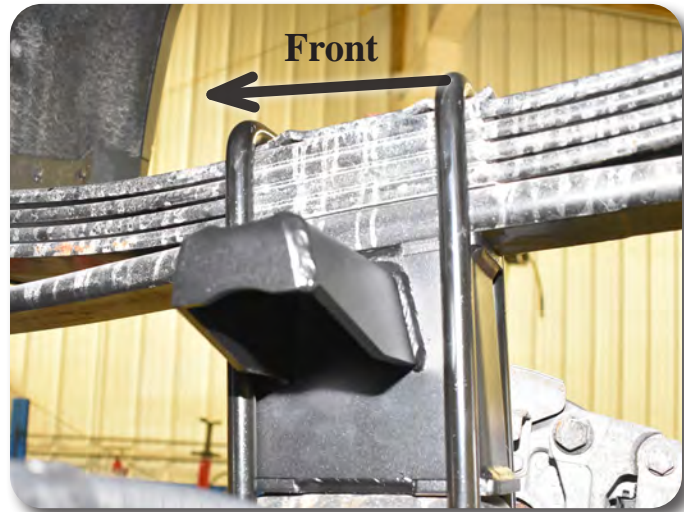

Figure 54A



Figure 54B

### Step 11 Note

Brake line hardware is located in bolt pack #873.

10. Repeat block installation of the driver's side.
11. Install the rear brake line relocation bracket to the differential using the factory hardware. Using the provided 5/16" hardware attach the rear brake line bracket to the relocation bracket **Figure 55**.



Figure 55

12. Install the rear ABS line relocation bracket to the differential using the factory hardware. Using the provided 1/4" hardware attach the rear brake line bracket to the relocation bracket Figure 56.

### Step 11 Note

ABS line hardware is located in bolt pack #873.



Figure 56

13. The passenger's side bump stop bracket on the axle must be trimmed slightly to add clearance for the new larger rear shocks. Grind the inside front corner to gain approximately 1/4" of clearance. Figure 57 Paint bare metal to prevent rust.

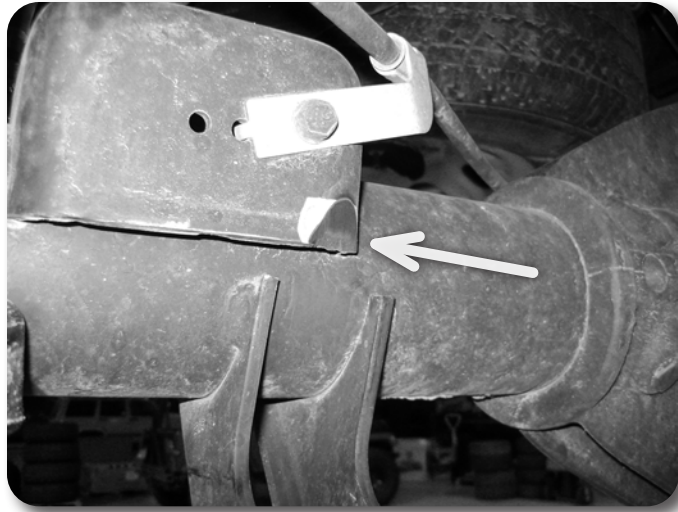

Figure 57

14. Install new rear shocks with the provided hardware. Fasten the shocks with the factory hardware and torque to 100 ft-lbs.
15. Check all cables for adequate slack at full droop, make adjustments if necessary.
16. Remove clips on wheels **Figure 58**. Reinstall wheels and lower vehicle to the ground. Torque u-bolts to 125 ftlbs. Torque lug nuts to 140 ft-lbs.

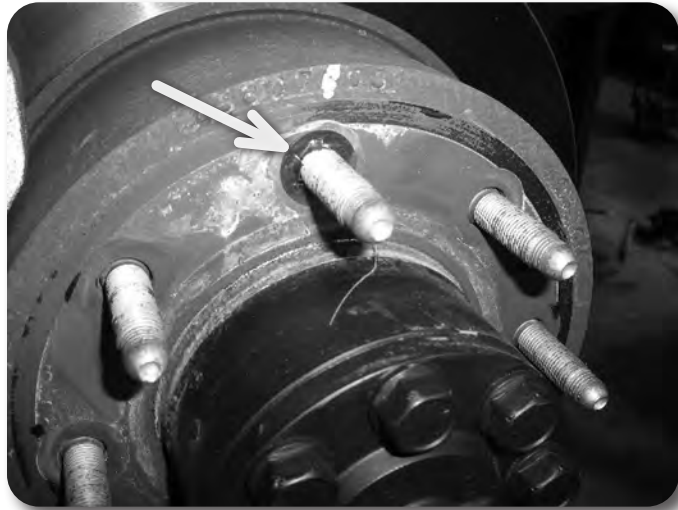

Figure 58

## Post-Installation Warnings

1. Check all fasteners for proper torque. Check to ensure for adequate clearance between all rotating, mobile, fixed, and heated members. Verify clearance between exhaust and brake lines, fuel lines, fuel tank, floor boards and wiring harness. Check steering gear for clearance. Test and inspect brake system.
2. Perform steering sweep to ensure front brake hoses have adequate slack and do not contact any rotating, mobile or heated members. Inspect rear brake hoses at full extension for adequate slack. Failure to perform hose check/ replacement may result in component failure.
3. Perform head light check and adjustment.
4. Re-torque all fasteners after 500 miles. Always inspect fasteners and components during routine servicing.

## Post-Installation

17. Check all hardware for proper torque.
18. Reconnect the positive and negative battery cables.

## Set Front Suspension Height

1. It is very common for the particular vehicle model to have widely varying starting suspension heights. In order to give a more precise suspension height setting we have provided a Z-height reference. Refer to **Figure A**

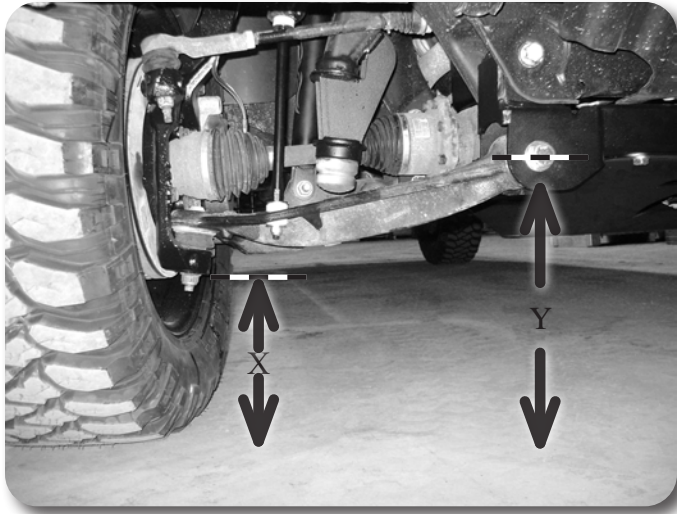

Figure A

2. Roll the vehicle forward and back to settle the front suspension. With the vehicle on flat, level ground measure the distance from the floor to the center of the front lower control arm bolt. This is distance 'Y'. Record here: \_\_\_\_\_
3. Measure from the floor up to the lowest point on the new steering knuckle, near the ball joint. Figure B. This is distance 'X'. Record here: \_\_\_\_\_



Figure B

4. To determine the Z-height use the following equation:  $Y-X=Z$ . For the intended 5" of lift the value for Z should be approximately 5-1/4". The Z-height (ride height) for this kit can be adjusted up to a max of 6-1/4" and to a minimum of 4-1/2".

### Final Check

1. The vehicle will need a complete front end alignment.
2. Check all hardware after 500 miles.
3. Adjust headlights. Rivet Nut Installation Instructions

## Detailed Rivet Nut Installation Instructions

### » HOLE PREPARATION

1. Drill hole to appropriate size for rivet nut installation. 1/2" Rivet nuts require an 11/16" hole and 3/8" Rivet nuts require a 17/32" drill. It is critical that this hole is drilled to the correct size. Remove any burrs that could keep the rivet nut from seating flat against either side of the hole surface.

### Step 1 Note

If the correct drill size is not available, it is possible to drill the hole to an available smaller size and slowly grind it out to until the rivet-nut fits tight.

### » RIVET NUT INSTALLATION TOOL ASSEMBLY

2. For a 3/8" rivet nut, place the provided 3/8" SAE flat washer on the 3/8" x 1-1/2" bolt, followed by 7/16" hex nut and then a 3/8" serrated washer. Figure 1 Thread this tool assembly into the rivet nut.
3. For a 1/2" rivet nut, place the provided 1/2" SAE washer on a 1/2" x 2" bolt followed by a 9/16" high nut and 1/2" serrated edge lock washer. Thread this tool assembly into the rivet nut as shown. Figure 1.

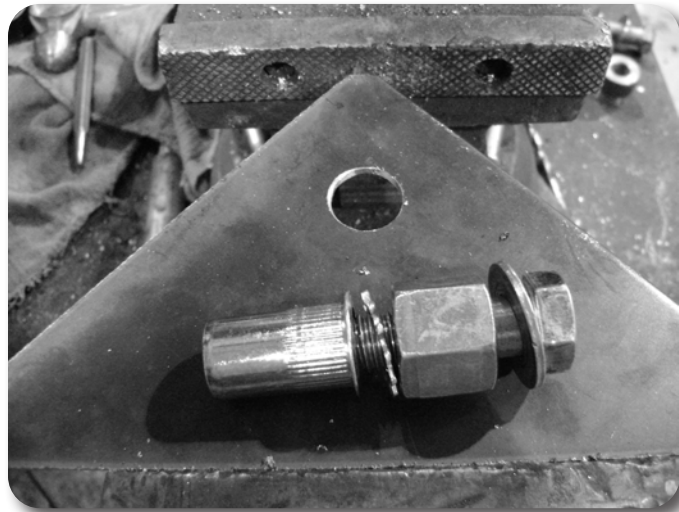

Figure 1 - 1/2" Rivet Nut Shown

### » RIVET NUT INSTALLATION

4. Verify the correct size rivet nut for the application based on the thickness of material where the rivet nut is to be installed using the following chart.

Part Number	Thread Size	Body Length (in)	Material Thickness (in)		Drill Size (in)
			Min.	Max.	
95105A159	3/8-16	.690	.027	.150	17/32
95105A168	3/8-16	.805	.150	.312	17/32
95105A169	1/2-13	1.150	.063	.200	11/16
95105A170	1/2-13	1.300	.200	.350	11/16

5. Place the installation tool with the rivet nut threaded on the end into the appropriately sized hole.

6. For a 3/8" rivet nut, hold the high nut closest to the rivet nut still with an 5/8" wrench and tighten the 3/8" bolt with a 9/16 wrench or impact gun to set the rivet nut. Be sure to hold the rivet nut flush to the surface and square to the hole as it is tightened.
7. For a 1/2" rivet nut, hold the high nut closest to the rivet nut still with an 7/8" wrench and tighten the 1/2" bolt with a 3/4" wrench or impact gun to set the rivet nut. Be sure to hold the rivet nut flush to the surface and square to the hole as it is tightened.

### Step 6 & 7 Note

If available, an impact gun is recommended for tightening the bolt to ensure the rivet nut remains square to the hole and to ease holding the nut from spinning.

---

### » TORQUE SPECIFICATIONS

8. 3/8" rivet nuts will approach 40 ft. lbs for maximum grip strength. Do not exceed 45 ft-lbs when setting the rivet nut.
9. 1/2" rivet nuts will approach 90 ft lbs for maximum grip strength. Do not exceed 100 ft-lbs when setting the rivet nut.

### Step 8 & 9 Note

If using the recommended impact gun, use caution to not exceed the recommended torque specifications.

---

### » RIVET NUT TOOL REMOVAL

10. Once the center bolt is tightened, remain holding the nut from spinning with the wrench and loosen the center bolt to remove the installation tool.
11. Verify proper installation by checking for consistent rivet nut deformation to see the threads are square and centered to the rivet nut. Figure 2.



Figure 2

### Step 10 \*IMPORTANT\*

It is very important to hold the nut as the bolt is loosened because the grip of the star washer will try to spin the rivet nut and ruin the installation.