

INSTALLATION GUIDE

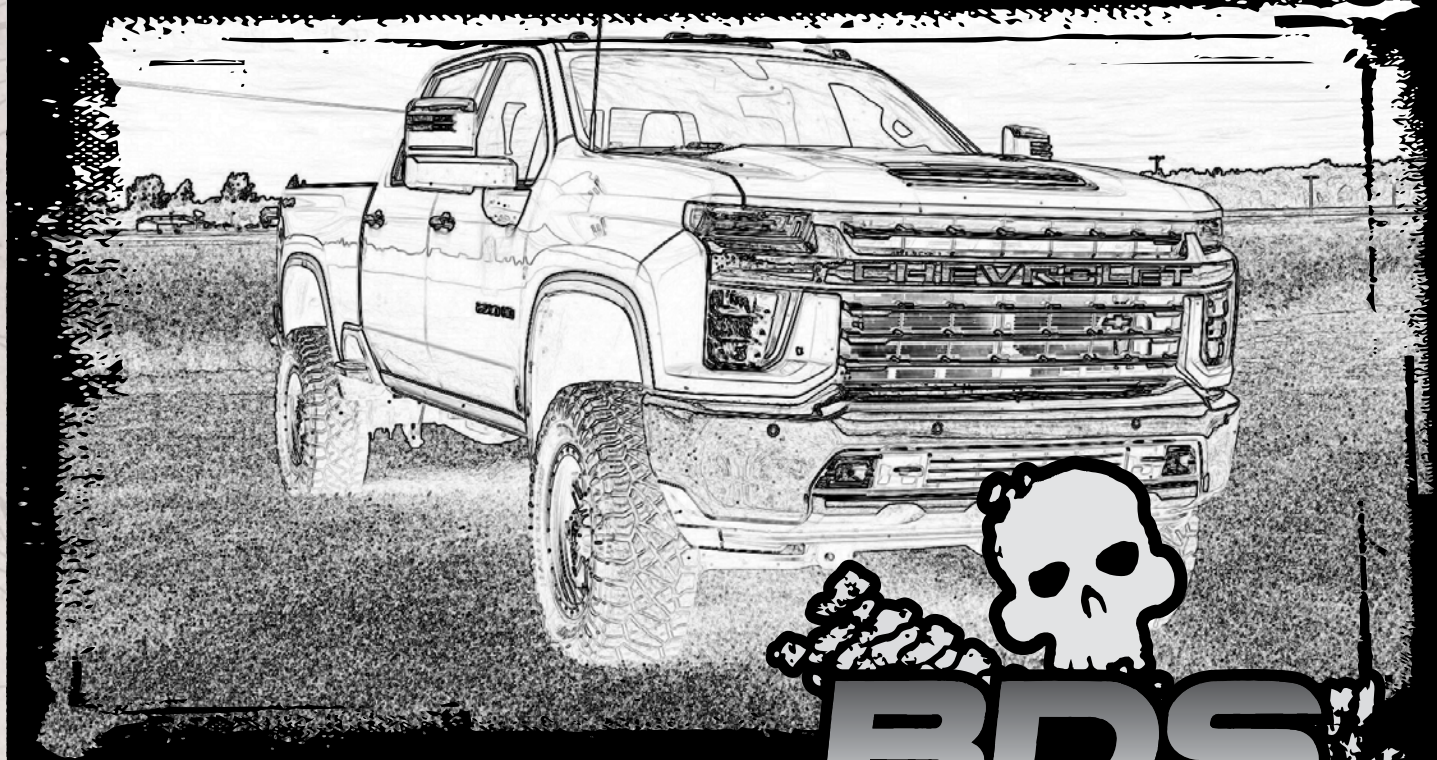

Part#: 021693



HARDCORE LIMITED LIFETIME WARRANTY

6.5" & 5" High Clearance Suspension System

Chevy/GMC 2500/3500 HD Pickup 2WD/4WD | 2020-22

Rev. 123022

491 W. Garfield Ave., Coldwater, MI 49036 • Phone: 517-279-2135

E-mail: tech-bds@ridefox.com

Read And Understand All Instructions And Warnings Prior To Installation Of System And Operation Of Vehicle.

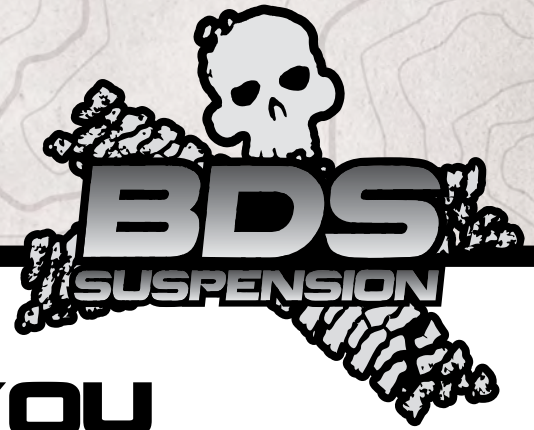

THANK YOU

Your truck is about to be fitted with the best suspension system on the market today. That means you will be driving the baddest looking truck in the neighborhood, and you'll have the warranty to ensure that it stays that way for years to come. Thank you for choosing BDS Suspension!

BEFORE YOU START

BDS Suspension Co. recommends this system be installed by a professional technician. In addition to these instructions, professional knowledge of disassembly/ reassembly procedures and post installation checks must be known.

FOR YOUR SAFETY

Certain BDS Suspension products are intended to improve off-road performance. Modifying your vehicle for off-road use may result in the vehicle handling differently than a factory equipped vehicle. Extreme care must be used to prevent loss of control or vehicle rollover. Failure to drive your modified vehicle safely may result in serious injury or death. BDS Suspension Co. does not recommend the combined use of suspension lifts, body lifts, or other lifting devices. You should never operate your modified vehicle under the influence of alcohol or drugs. Always drive your modified vehicle at reduced speeds to ensure your ability to control your vehicle under all driving conditions. Always wear your seat belt.

BEFORE INSTALLATION

- Special literature required: OE Service Manual for model/year of vehicle. Refer to manual for proper disassembly/reassembly procedures of OE and related components.
- Adhere to recommendations when replacement fasteners, retainers and keepers are called out in the OE manual.
- Larger rim and tire combinations may increase leverage on suspension, steering, and related components. When selecting combinations larger than OE, consider the additional stress you could be inducing on the OE and related components.
- Post suspension system vehicles may experience drive line vibrations. Angles may require tuning, slider on shaft may require replacement, shafts may need to be lengthened or trued, and U-joints may need to be replaced.
- Secure and properly block vehicle prior to installation of BDS Suspension components. Always wear safety glasses when using power tools.
- If installation is to be performed without a hoist, BDS Suspension Co. recommends rear alterations first.
- Due to payload options and initial ride height variances, the amount of lift is a base figure. Final ride height dimensions may vary in accordance to original vehicle attitude. Always measure the attitude prior to beginning installation.



Visit 560plus.com for more information.

TIRES AND WHEELS

6.5" Kit:

37 x 12.50 on 17" x 9" w/ 4-1/2 to 4-5/8" Backspacing
37 x 12.50 on 18" x 9" w/ 4-1/2 to 4-5/8" Backspacing
38 x 13.50 on 20" x 9" w/ 5-1/2 Backspacing
37 x 12.50 on 20" x 9" w/ 4-1/2 to Stock Backspacing
Larger than 20", use 20" wheel specs

5" Kit:

35 x 12.50 on 17" x 9" or 18 x 9" w/ 4-1/2 to 4-5/8" Backspacing
37 x 12.50 on 20" x 9" w/ 5 to 5-1/2" Backspacing
35 x 12.50 on 20" x 9" w/ 4-1/2 to Stock Backspacing
Larger than 20", use 20" wheel specs

Stock 20" x 8.5" wheels with factory 6.18" backspacing MAY fit with a max tire size of 37 x 12.50 on certain tire sidewall profiles due to clearance to the steering knuckle. A minimum 1/4" wheel spacer may be required due to tire side wall profile variations. A wider tire will cause clearance issues with the steering knuckle. Stock 17" and 18" wheels will not fit back on the vehicle once this suspension system is installed."

BEFORE YOU DRIVE

Check all fasteners for proper torque. Check to ensure for adequate clearance between all rotating, mobile, fixed, and heated members. Verify clearance between exhaust and brake lines, fuel lines, fuel tank, floor boards and wiring harness. Check steering gear for clearance. Test and inspect brake system.

Perform steering sweep to ensure front brake hoses have adequate slack and do not contact any rotating, mobile or heated members. Inspect rear brake hoses at full extension for adequate slack. Failure to perform hose check/ replacement may result in component failure. Longer replacement hoses, if needed can be purchased from a local parts supplier.

Perform head light check and adjustment.

Re-torque all fasteners after 500 miles. Always inspect fasteners and components during routine servicing.

CONTENTS OF YOUR KIT

021693 - Front Box Kit		
Part #	Qty	Description
02363B	1	Rear Cross Member
03876	1	Differential Bracket - DRV
03877	1	Differential Bracket - Center
02371B	1	Differential Bracket - PASS
02372B	1	Differential Skid Plate
342701	1	Thread locker
70	1	Sleeve - Center Differential Bracket
3523BK	2	Bushing - Center Differential Bracket
099000	3	Cable Tie
585	1	Bolt Pack - Lower Control Arms
	2	18mm-2.50 x 120mm bolt class 10.9 yellow zinc
	2	18mm-2.50 x 140mm bolt class 10.9 yellow zinc
	4	18mm-2.50 prevailing torque nut yellow zinc
	8	3/4" SAE flat washer yellow zinc
586	1	Bolt Pack - Differential Drop
	6	1/2"-13 x 1-1/4" bolt grade 8 yellow zinc
	2	1/2"-13 x 1-1/2" bolt grade 8 yellow zinc
	2	1/2"-13 x 3-1/2" bolt grade 8 yellow zinc
	4	1/2"-13 prevailing torque nut yellow zinc
	12	1/2" SAE flat washer yellow zinc
	4	1-3/8"OD x 1/2"ID x 3/16" Thk washers zinc - yellow or clear
	2	12mm-1.75 x 40mm bolt class 10.9 clear zinc
	1	9/16"-12 x 4" bolt grade 8 yellow zinc
	1	9/16"-12 prevailing torque nut yellow zinc
	2	9/16" SAE flat washer yellow zinc
	4	10mm-1.50 x 40mm bolt class 10.9 clear zinc
	4	10mm flat washer clear zinc

021690 / 021691 - Knuckle Box Kits		
Part #	Qty	Description
03825	1	Steering Knuckle - DRV (021690 Only)
03826	1	Steering Knuckle - PASS (021691 Only)
590	1	Bolt Pack
	6	Wire Clamp
	6	1/4"-20 x 5/8" Bolt, Grade 5
	6	1/4" Lock Washer
	6	6mm Washer (12mm OD)

021694 - 6.5" Front Box Kit Only		
Part #	Qty	Description
03994	1	Torsion Bar Bracket - DRV
03995	1	Torsion Bar Bracket - PASS
02367	2	T-Bar Bracket Spacer - Front
05074	2	T-Bar Bracket Spacer - Rear (Grooved)
03468	2	Torsion Bolt Retaining Bracket
899	1	Bolt Pack - Torsion Bar Brackets
	2	1" USS flat washer clear zinc
587	1	Bolt Pack - Torsion Bar Brackets
	2	1"-8 x 6-1/2" bolt grade 5 clear zinc
	4	1" USS flat washer clear zinc
	2	1"-8 nylock nut clear zinc
	2	14mm-2.00 x 70mm bolt class 10.9 clear zinc
	2	14mm flat washer clear zinc
	2	9/16" SAE extra thick washer thru-hardened clear zinc
	2	14mm-2.00 prevailing torque nut clear zinc
	2	9/16" SAE flat washer thru-hardened yellow zinc

011516 - 6" Rear Box Kit - Non Overload		
011526 - 6" Rear Box Kit - With Overload		
Part #	Qty	Description
03884	1	2020 GM HD Rear Block - DRV
03885	1	2020 GM HD Rear Block - PASS
343251550QB	4	3/4 x 3-1/4 x 15-1/2 Square U-Bolt Black (011516 Only)
343141912QB	4	3/4 x 3-1/4 x 19-1/2 Square U-Bolt Black (011526 Only)
03901	1	Rear Brake Line Bracket
03900	1	ABS Line Bracket
099000	2	Cable Tie
N34FLG-B	8	3/4"-10 Serrated Flange Nut
873	1	Bolt Pack - Rear Brackets
	2	1/4"-20 x 1" Bolt - Grade 5 - Clear Zinc
	2	1/4"-20 Prevailing Torque Nut - Clear Zinc
	4	1/4" SAE Washer - Clear Zinc
	2	5/16"-18 x 3/4" Bolt - Grade 5 - Clear Zinc
	2	5/16"-18 Prevailing Torque Nut - Clear Zinc
	4	5/16" SAE Washer - Clear Zinc

021692 - Front Box Kit		
Part #	Qty	Description
03879	1	Front Cross Member
02373B	1	Cross Member Brace
22533D	1	Front Brake Line - DRV
22533P	1	Front Brake Line - PASS
5188	2	Brake Line Clip
CCW-03-050	4	Brake Line Crush Washer
65	2	.750 x .134 x 1.650 DOM Sleeve
162	2	0.750 x 0.134 x 1.255 Sleeve
M03212-BK-01	2	Offset Polyurethane Spacer
A361	2	Front Sway Bar Links
870	1	Bolt Pack
	2	12mm-1.75 x 80mm bolt class 10.9 clear zinc
	2	12mm-1.75 x 65mm bolt class 10.9 clear zinc
	4	12mm-1.75 prevailing torque nut clear zinc
	8	7/16" USS flat washer clear zinc

Cont'd

021692 - Front Box Kit (Cont'd)

Part #	Qty	Description
877	1	Bolt Pack - Front Brake Lines
	10	Wire Clamp
	8	1/4"-20 x 5/8" bolt grade 5 clear zinc
	8	1/4" lock washer clear zinc
	8	6mm flat washer - clear zinc

121661 - Skid Plate Box Kit

Part #	Qty	Description
03902	1	Front Skid Plate
B1308	1	Bag Kit- BDS Badge

021505 - 5" Front Box Kit

Part #	Qty	Description
03886	1	Torsion Bar Bracket -DRV
03887	1	Torsion Bar Bracket - PASS
02367	2	T-Bar Bracket Spacer - Front
05074	2	T-Bar Bracket Spacer - Rear (Grooved)
03468	2	Torsion Bolt Retaining Bracket
899	1	Bolt Pack - Torsion Bar Brackets
	2	1" USS flat washer clear zinc
587	1	Bolt Pack - Torsion Bar Brackets
	2	1"-8 x 6-1/2" bolt grade 5 clear zinc
	4	1" USS flat washer clear zinc
	2	1"-8 nylock nut clear zinc
	2	14mm-2.00 x 70mm bolt class 10.9 clear zinc
	2	14mm flat washer clear zinc
	2	9/16" SAE extra thick washer thru-hardened clear zinc
	2	14mm-2.00 prevailing torque nut clear zinc
	2	9/16" SAE flat washer thru-hardened yellow zinc

011416 - 4.5" Rear Box Kit - Non Overload**011426 - 4.5" Rear Box Kit - With Overload**

Part #	Qty	Description
03882	1	2020 GM HD Rear Block - DRV
03883	1	2020 GM HD Rear Block - PASS
343251550QB	4	3/4 x 3-1/4 x 15-1/2 Square U-Bolt Black (011416 Only)
343141800QB	4	3/4 x 3-1/4 x 18 Square U-Bolt Black (011426 Only)
03878	1	Rear Brake Line Bracket
03667	1	ABS Line Bracket
099000	2	Cable Tie
N34FLG-B	8	3/4"-10 Serrated Flange Nut
873	1	Bolt Pack - Rear Brackets
	2	1/4"-20 x 1" Bolt - Grade 5 - Clear Zinc
	2	1/4"-20 Prevailing Torque Nut - Clear Zinc
	4	1/4" SAE Washer - Clear Zinc
	2	5/16"-18 x 3/4" Bolt - Grade 5 - Clear Zinc
	2	5/16"-18 Prevailing Torque Nut - Clear Zinc
	4	5/16" SAE Washer - Clear Zinc

IMPORTANT INFORMATION FOR YOUR VEHICLE

1. Do not install this suspension system in conjunction with any type of torsion bar lift keys.
2. Models with two-piece rear drive shafts will require a carrier bearing drop kit.
3. Requires frame bracket modification.
4. Disassembly/assembly of the factory torsion bar system requires the use of a special unloading tool. The GM specified tool # is CH48809.
5. Order correct rear box kit to work with a top mounted overload springs or add-a-leafs. (011516 (6.5") or 011416 (5") without overloads; 011526 (6.5") or 011426 (5") with overloads)
6. Compatible with gas or diesel models as well as standard or AT4 models.
7. Some minor trim will be required with certain wheel/tire combination. This is normal with most aftermarket tire/wheel fitment on Chevy/GM trucks. Trimming will normally included the bottom edge of the inner fender shrouds and/or lower corner of front bumper valance. As a rule of thumb, deeper backspacing and shorter/narrower tires will reduce/eliminate trimming required. Further trimming tips are included at the end of this instruction sheet.
8. Factory 17-18" wheels cannot be reinstalled due to tie rod end interference, stock 20" wheels can be reinstalled with up to a 35x12.50 tire.
9. In some cases vehicles used in 4WD on the highway regularly could potentially experience a minor front driveline vibration. If this occurs we recommend replacing the front driveshaft with a dual Cardan style driveshaft.

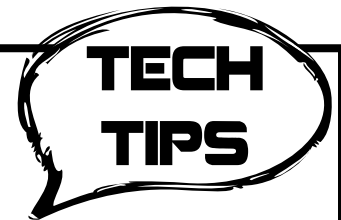

INSTALLATION INSTRUCTIONS

FRONT INSTALLATION

1. Park the vehicle on a flat, clean surface and block the rear wheels for safety.
2. Raise the front of the vehicle and support with jack stands under the frame rails.
3. Remove the wheels.
4. Measure and record the length of the exposed thread on the torsion bar adjuster bolts (Fig. 1). Record the lengths here for use later during the installation

SPECIAL TOOLS

1-1/2" (38mm) socket/wrench
36mm socket
T30 Torx bit
1-1/16" (27mm) socket/wrench
Torsion Bar Unloading tool (see Pre-Installation Note #2)
Reciprocating Saw
4" Cut-off Wheel/Tool (optional)
3/16" Rivet Gun

DRV Side: _____ PASS Side: _____

FIGURE 1

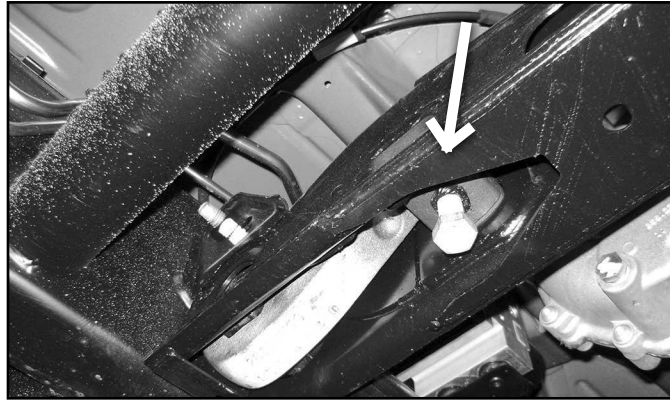

5. Unload the torsion bars but do not remove. Remove and save adjuster bolt/retainer block.



Tip

Torsion bars are under extreme pressure. A proper torsion bar tool is necessary to unload the bars. A tool designed specifically for GM torsion bars is required see troubleshooting note #2.

6. Mark the unloaded torsion bars to indicate DRV side and PASS side. Also mark the bars to indicate front versus rear.
7. Remove the torsion bar adjuster key by pushing the torsion bar forward to allow the key to drop free. On some vehicles this will require using a hammer/punch or air hammer. Access the end of the torsion bar through the hole in the back of the torsion bar cross member and drive forward. Leave the torsion bars in the lower control arms.
8. The torsion bar cross member can either be removed, allowing the torsion bars to be removed out the back of the vehicle. Or the torsion bar and lower control arms can be removed together later in the installation, leaving the torsion bar cross member in place.
9. If equipped, remove the four bolts mounting the factory belly pan to the frame and the two bolts mounting the front skid to the cross member (Fig. 2). These will not be reused.

FIGURE 2



10. Disconnect the sway bar end links from the sway bar and then the lower control arms (Fig. 3). Discard the link assemblies.

FIGURE 3

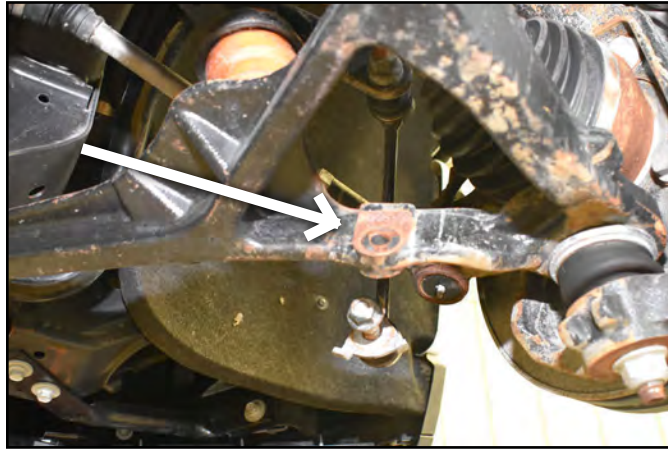

11. Disconnect the tie rod ends from the steering knuckles (Fig. 4). Remove the tie rod end nuts and save. Strike the knuckle near the tie rod end to dislodge the tie rod end taper. Remove the tie rod ends from the knuckles.

FIGURE 4



12. Remove the plastic retainers holding the ABS / brake wire to the brackets frame (Fig. 5) and the knuckle (Fig. 6a Fig. 6b) (Driver Side Shown). Leave the brackets attached to the frame and knuckle. Disconnect the ABS Sensor from the steering knuckle (Fig. 7).

FIGURE 5

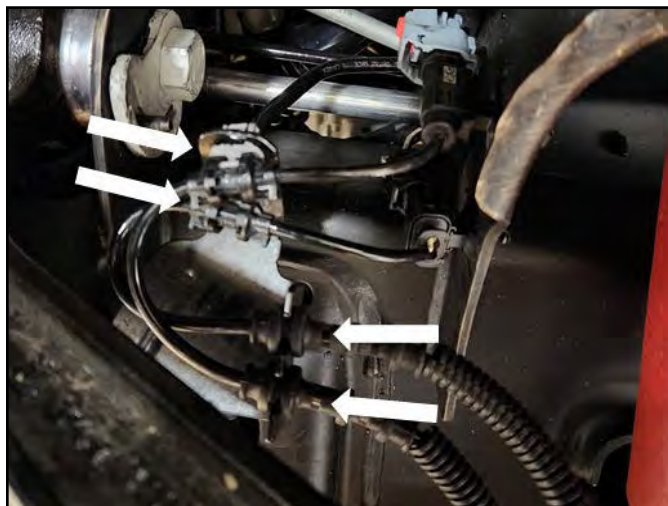

FIGURE 6A

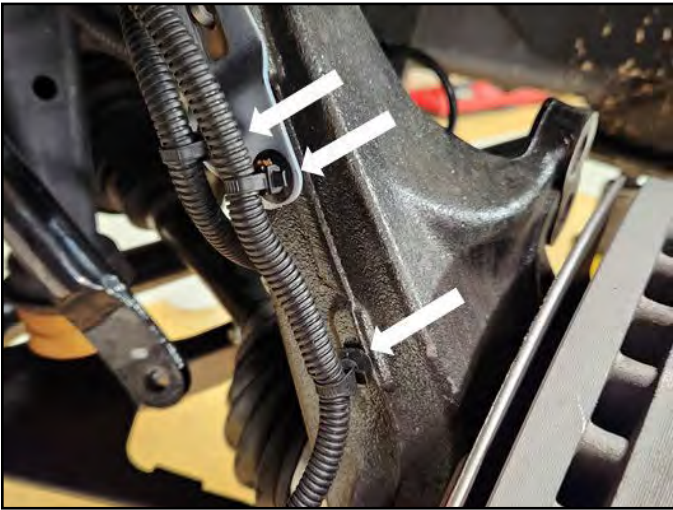

FIGURE 6B

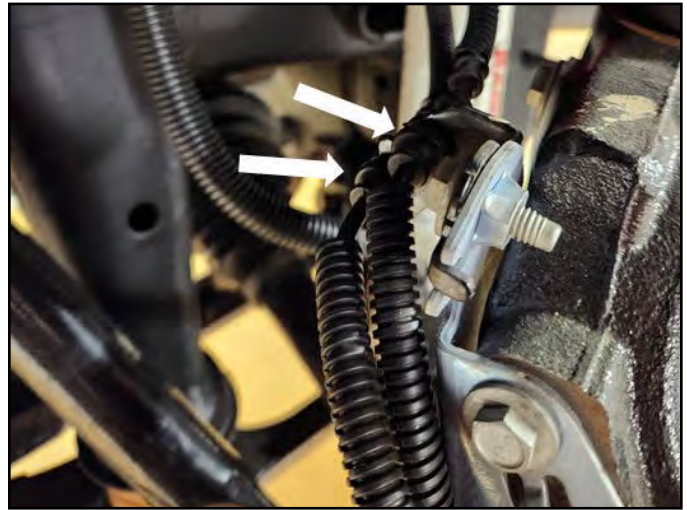

FIGURE 7



13. Remove the four bolts mounting the brake caliper assembly to the steering knuckle and hang the caliper out of the way (Fig. 8). Do not hang the caliper by the brake hose. Save mounting bolts.

FIGURE 8



- Carefully remove the hub dust cover. Save cover (Fig. 9).

FIGURE 9

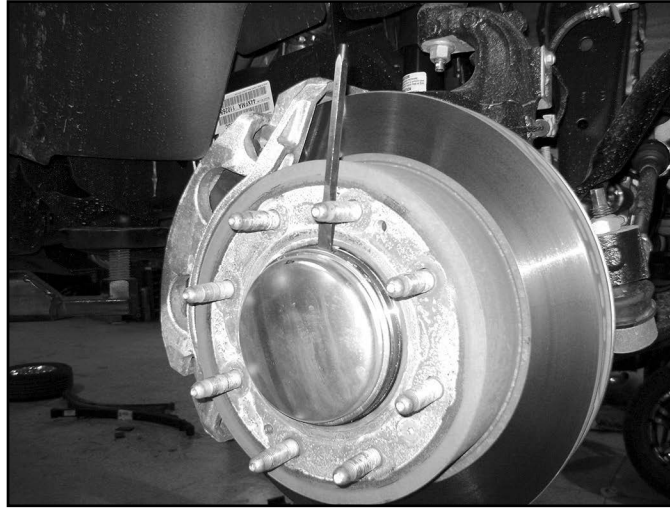

- Remove the rotor retaining bolt using a T30 torx bit (Fig. 10). Remove the brake rotor and set aside. Save retaining bolt.
- Remove the CV axle nut and washer (Fig. 10). Save hardware.

FIGURE 10

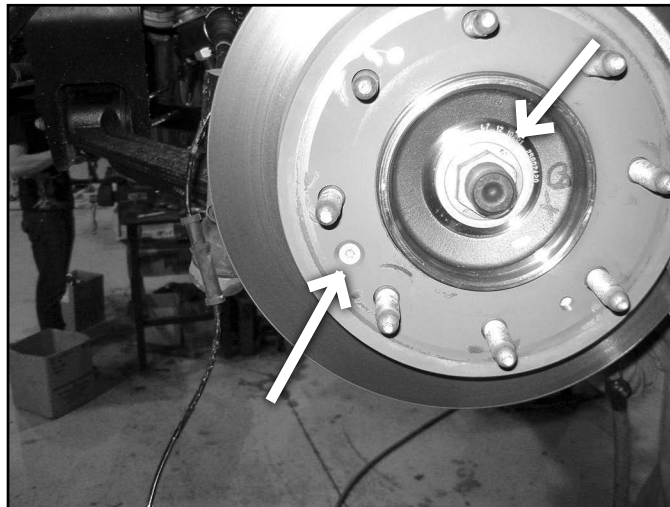

- Remove the upper ball joint nut. Reinstall the nut a couple of turns by hand. Strike the knuckle near the ball joint to release the taper. Remove the nut let the knuckle hang down. Take care not to strike the ball joint.

18. Locate and remove the four hub bearing assembly bolts (Fig. 11). The bolts are accessed from the back side of the steering knuckle. (Note: the CV axle may need to separate from the bearing to gain access to the bolts)

FIGURE 11

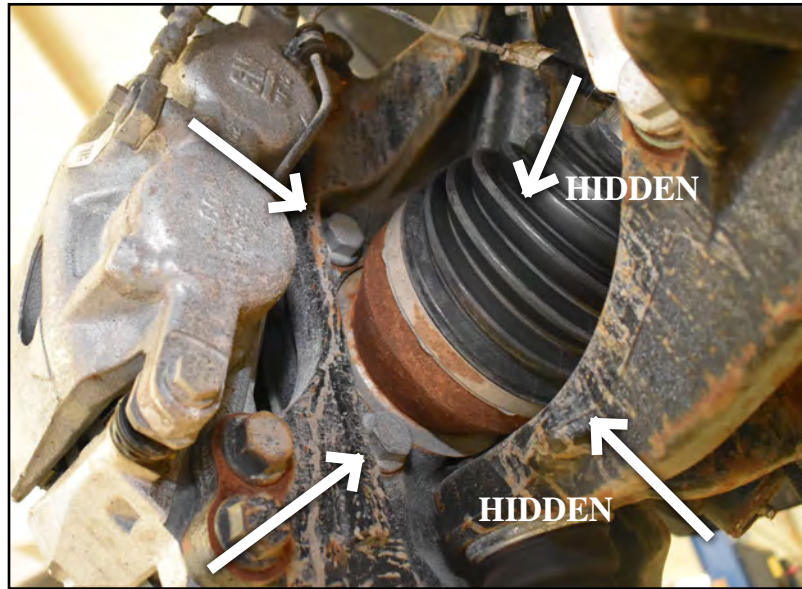

19. Remove the hub bearing assembly and dust shield from the steering knuckle. Take care not to damage to O-ring. Save dust shield, o-ring, and hub bearing for later installation.
20. Remove lower ball joint nut (Fig. 12). Reinstall the nuts a couple of turns by hand. Taking care not to strike the ball joint Strike the knuckle near the ball joints to release the taper. Remove the nut and remove the steering knuckle from the vehicle. Save nuts and the o-rings.

FIGURE 12



21. Remove the CV axle flange bolts at the differential (Fig. 13). There are 8 bolts per side. Remove the CV shafts from the vehicle and set aside. Save bolts.

FIGURE 13

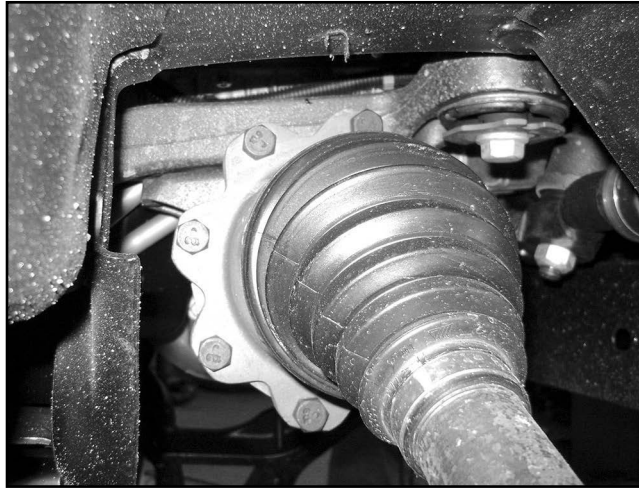

22. Disconnect the shocks from the frame (Fig. 14) and lower control arm (Fig. 15). Remove shocks. Save the upper and lower shock mount hardware.

FIGURE 14

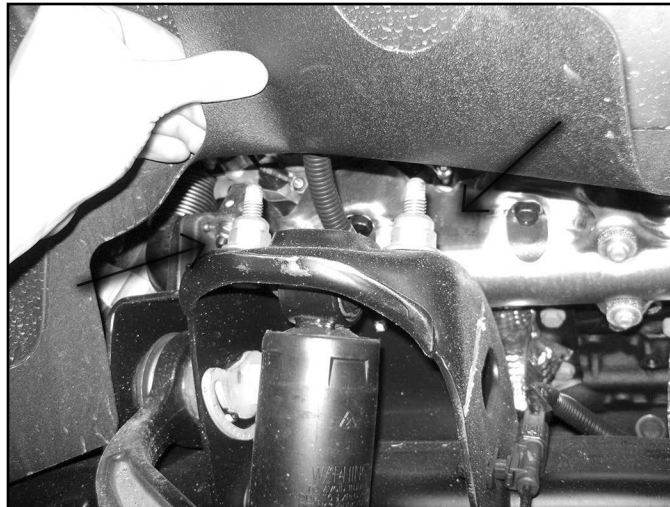
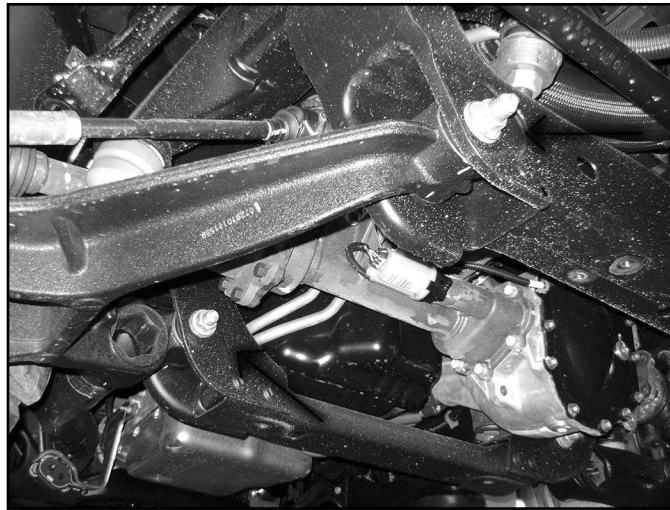

FIGURE 15



23. Remove the front and rear lower control arm bolts and remove the control arms from the vehicle (Fig. 16). Save the control arms and mounting hardware.

FIGURE 16



24. There are two factory bump stops per side. Remove front rubber bump stop from the frame mounts on each side. They can be removed with a pair of channel-lock pliers or by striking them with a rubber mallet. Leave the rear bump stop installed in the frame mount.
25. Make an alignment mark on the front drive shaft and front differential input yoke. Remove the four bolts/clamps from the yoke and remove the front drive shaft from the differential (Fig. 17). Save the drive shaft hardware.

FIGURE 17

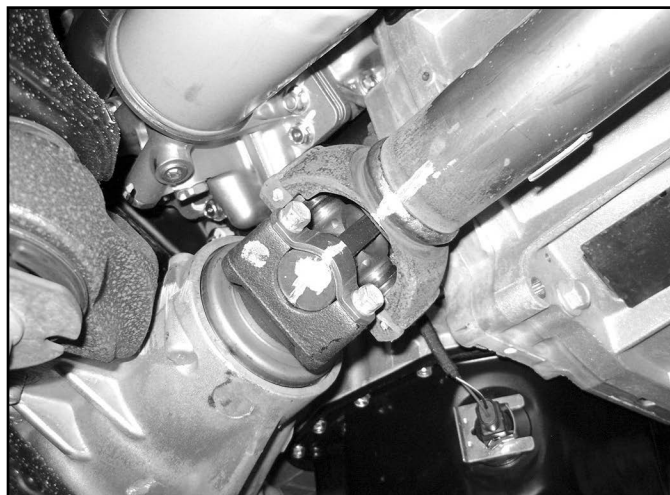

26. Remove the four bolts mounting the rear cross member to the rear lower control arm pockets (Fig. 18). Remove the cross member from the vehicle. The cross member and hardware will not be reused.

FIGURE 18

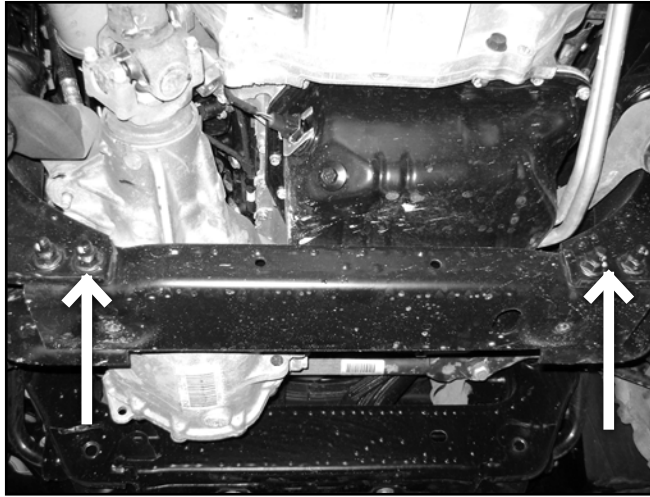

27. Disconnect the electrical connector from the front differential actuator (Fig. 19A). Remove the wire from the three plastic wire retainers along the top of the differential. Disconnect the axle breather tube from the top of the driver's side of the differential (Fig. 19B).

FIGURE 19A



FIGURE 19B



28. Loosen but do not remove all of the front differential mounting bolts/nuts. There are two nuts on the passenger's side (Fig. 20A) and three bolts on the driver's side (Fig 20B - two mount from the bottom up and one from the top down). Remove the rear-most bolt mounting from the top.

FIGURE 20A

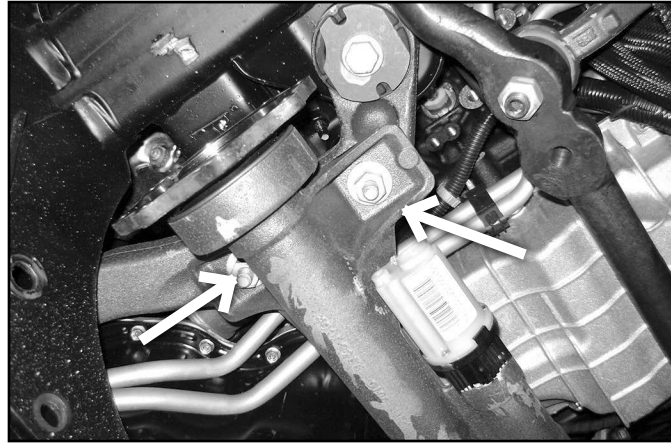
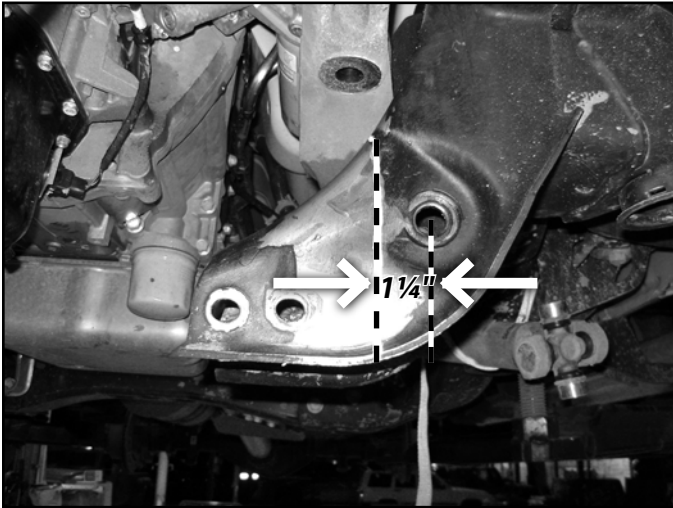

FIGURE 20B



29. Support the front differential with an appropriate jack. Remove the differential mounting hardware and lower the differential from the vehicle and set aside. Save hardware.
30. The lower rear driver's side control arm pocket must be trimmed to provide clearance for the front differential. On the front face measure from the center of the control arm mounting hole inward 1-1/4" and mark (Fig. 21A). On the back face measure from the center of the control arm mounting hole inward 2-1/2" and mark (Fig. 21B). Make vertical cut lines at the marks on the front and back faces. Along the top, connect the front and back cut lines with a diagonal cut line (Fig. 21C).

FIGURE 21A



Front Driver Side

FIGURE 21B

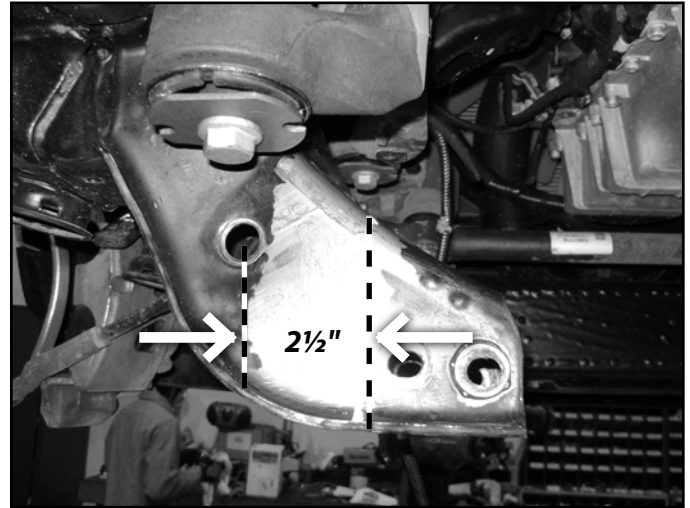

Rear Driver Side

FIGURE 21C



31. Using a reciprocating saw (recommended), cut-off wheel, or plasma cutter, cut the pocket along cut lines. Remove any burrs or rough edges and paint any bare metal to prevent corrosion.

32. Install the (2) provided large bushings and 0.875" OD x 2.620" long sleeve into the eye of the new center differential bracket (Fig. 22).

FIGURE 22



33. Locate the 4 housing bolts to be removed. Remove the four bolts, place the bracket in position and fasten with new 10mm x 40mm bolt and washers (BP #586). The bracket gusset will be toward the bottom of the differential (Fig. 23). Use thread locket on the bolt threads and torque to 59 ft-lbs.

FIGURE 23



34. Locate the new passenger's side differential bracket. Bracket has a single center gusset. Install the bracket on the existing studs on the passenger's side factory bracket. Fasten with the original nuts and washers. When installed the open side of the bracket will face inward and the bracket will taper down as it goes to the rear (Fig. 24). Torque nuts to 74 ft-lbs.

FIGURE 24

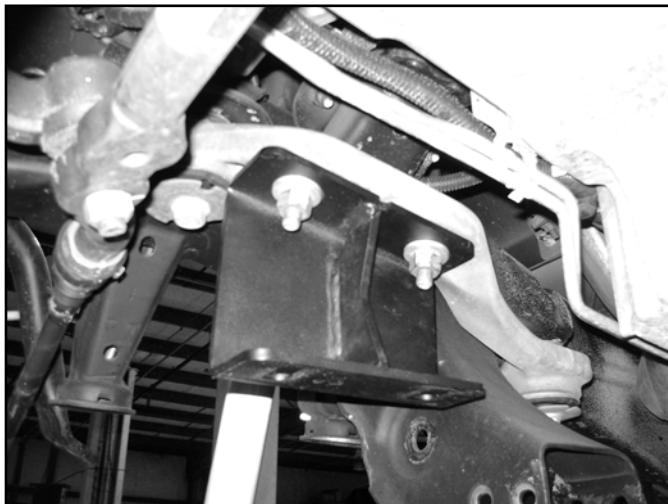

35. Locate the new driver's side differential bracket. Bracket has two center gussets. Install the bracket to the 2 front original differential mounting holes with the provided 12mm-1.75 x 40mm bolts and 1/2" SAE washers (BP #586), applying thread locker to the threads before installation. When installed the open side of the bracket will face inward and the bracket will taper down as it goes to the rear (Fig. 25). Torque bolts to 65 ft-lbs.

FIGURE 25

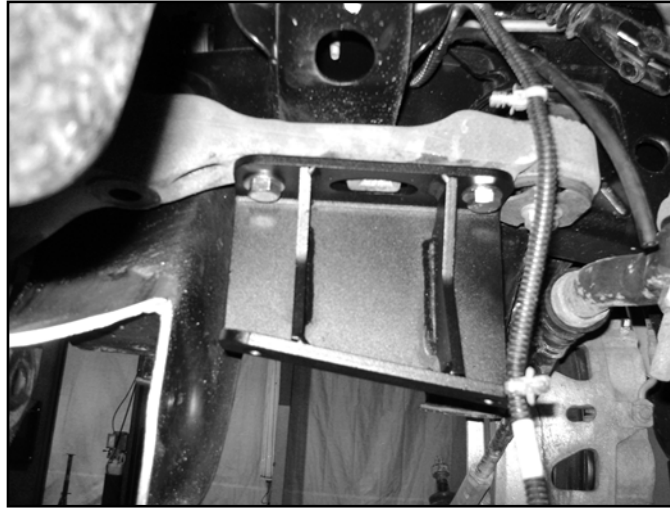

36. Using an appropriate jack, raise the differential up into the vehicle. Align the differential mounting holes to the new driver's and passenger's side differential brackets. Fasten to the driver's side mount with 1/2" x 3-1/2" bolts, nuts and 1/2" SAE flat washers (BP #586). Fasten the passenger's side 1/2" x 1-1/2" bolts, nuts and heavy 1/2" (large OD) washers. Snug up hardware, but do not tighten (Fig. 26).

Note: Check clearance between the CV flange mount and the flared surface on the factory rear cross member mount. This area on the frame may need to be clearanced with a grinder if it is too close to the CV flange mount.

FIGURE 26



37. Locate the new rear cross member. Install the cross member in the rear lower control arm pockets with the factory control arm bolts/nuts. Run the bolts from rear to front. The center differential bracket will fit into the mount tabs on the cross member. Fasten the differential mount to the cross member with a 9/16" x 4" bolt, nut and 9/16" SAE washers (BP #586). Leave hardware loose (Fig. 27).

FIGURE 27A

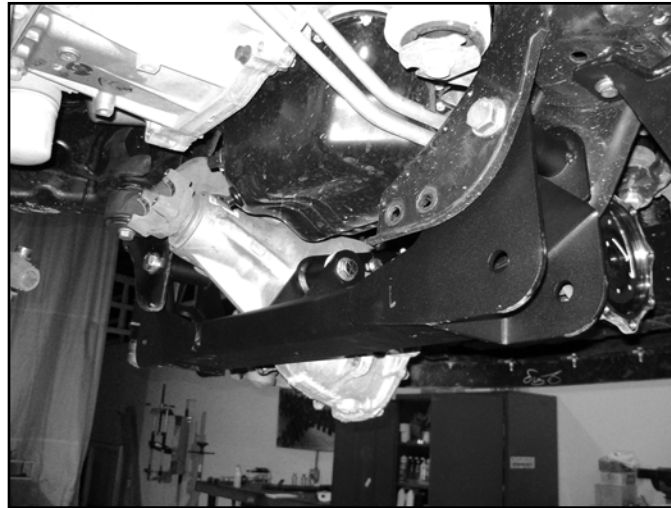

Note: OE front differentials have varied in design with and without ribs which may interfere with the replacement rear crossmember, The ribs on the differential may need to be ground down to clear the rear crossmember. See Figure 27B.

FIGURE 27B

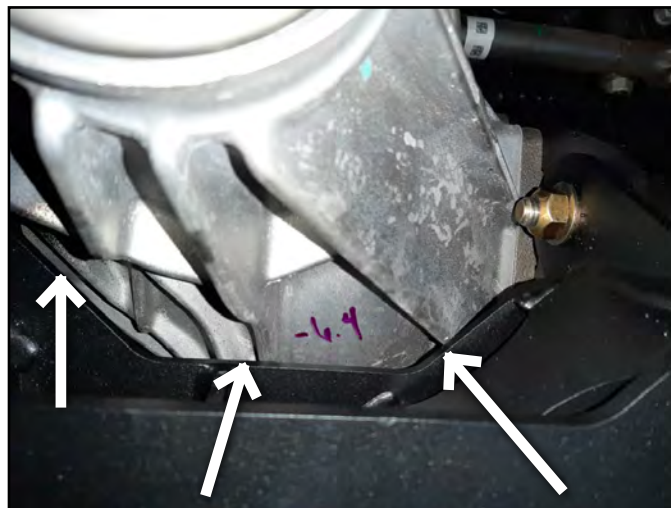

38. With the differential and rear cross member installed, tighten all the differential mount hardware. Torque the (4) 1/2" bolts to 65 ft-lbs and (1) 9/16" bolt to 95 ft-lbs.
39. Reconnect the front drive shaft to the front differential with the factory clamps and bolts; lining up the mark made in the previous step. Torque hardware to 25 ft-lbs.
40. Reconnect the front differential actuator wire. Reattach the wire harness to the housing. Use the provided zip ties where needed. Pull down on the differential breather hose to gain slack and reconnect to the top of the differential.

41. Locate the new front cross member. Install the cross member in the front lower control arm pockets and fasten with the original control arm bolts/nuts (Fig. 28). Run the bolt from front to rear. Leave hardware loose.

FIGURE 28



42. Locate the new provided aluminum torsion bar bracket spacers. There are 2 pairs of spacer. One pair has a groove cut in the flange which mount in the back side of the torsion bar hex holes in the factory lower control arms. The other pair mount in the front position (Fig. 29A/B).

FIGURE 29A



FIGURE 29B

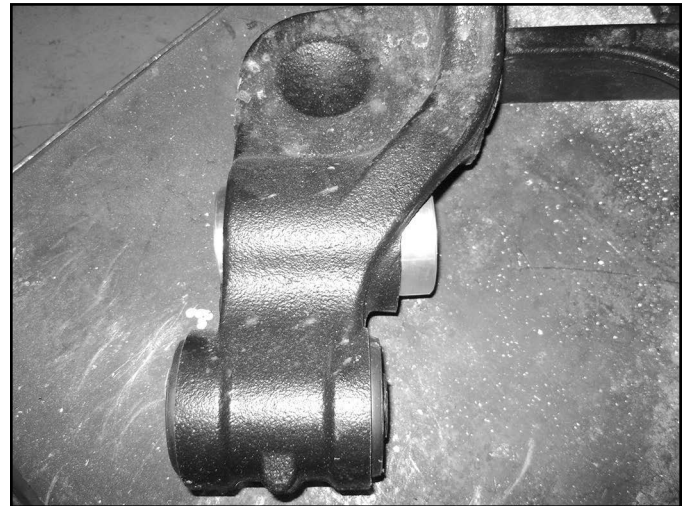

43. Locate the new torsion bar brackets (03994/03995 - 6.5" Kit or 03886/03887 5" Kit). They are driver's and passenger's side specific. **Some Models** may require (1) additional spacer washer in on the grooved aluminum spacer side due to factory lower control arm machining difference (Fig 30A). If the washer can fit on the back side as shown in Figure 30A, install the additional spacer washer. Slide the bracket onto the appropriate arm and fasten through the aluminum spacers with the provided 1" x 6" bolts, nuts and washers (BP 587). Check for clearance where the large offset bend is near the arm. **SOME** factory arms will need to be clearance slightly in this area to get the bolt into the stock shock location. Grind off a small amount if necessary, coat with paint (Fig. 30B, 30C). Run the bolts from front to back (Fig. 30D). The brackets will also align with the factory shock mount. The provided 9/16" SAE washer (BP #587) may be needed to be placed between the front bracket tab and the factory shock mount (Fig. 30E). Fasten with the factory lower shock bolt/nut. Leave all hardware loose.

FIGURE 30A

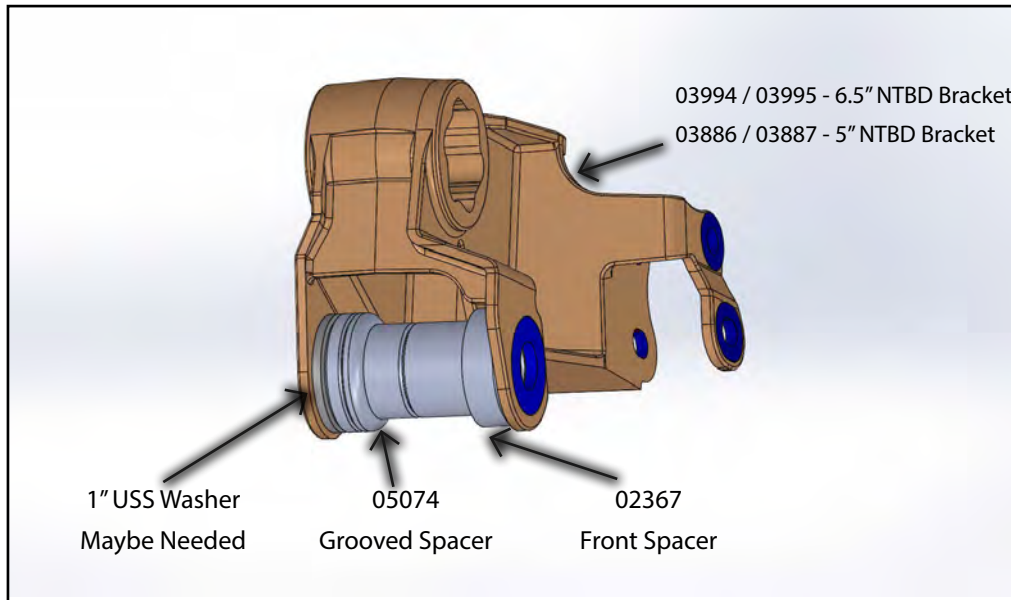

FIGURE 30B

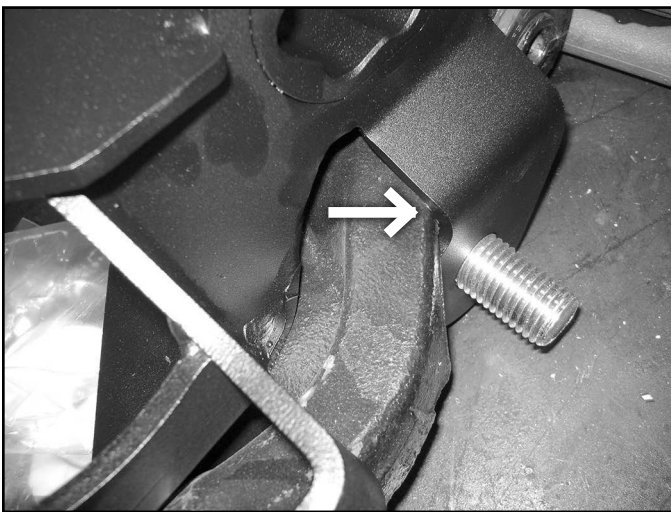

FIGURE 30C

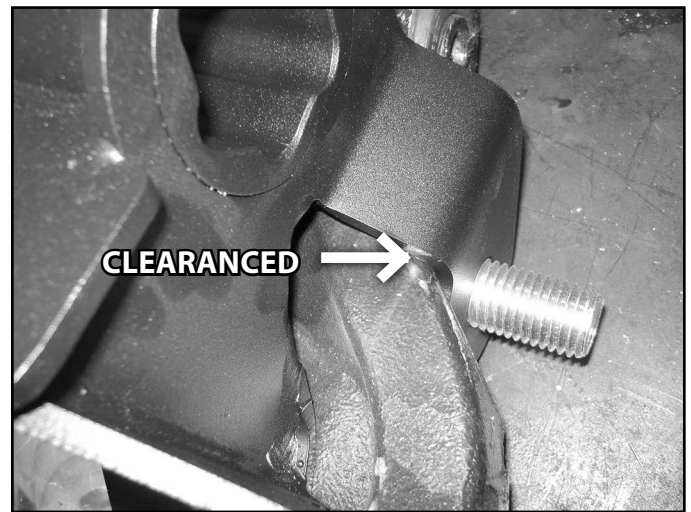

FIGURE 30D

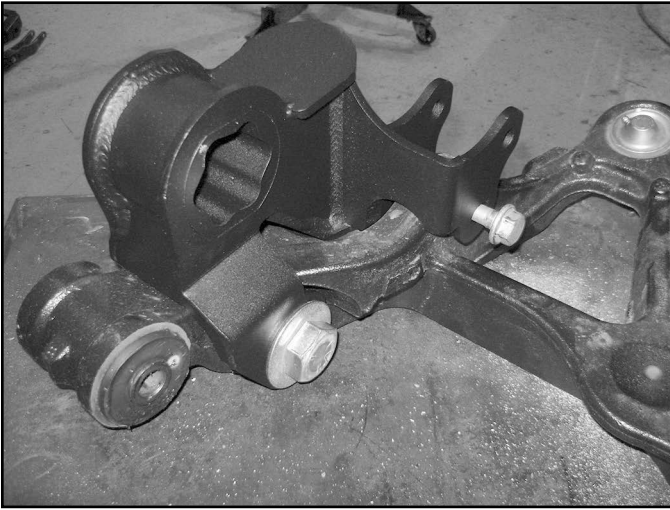

FIGURE 30E



44. With both new torsion bar bracket installed on the factory control arms, install the control arms in the cross members. Fasten the control arms with the provided 18mm x 120mm (front) and 18mm x 140mm (rear) bolts, nuts and 3/4" SAE flat washers (BP #585). Run the front bolts front-to-rear and the rear bolts rear-to-front (Fig. 31). Leave hardware loose. These bolts will be torque with the weight of the vehicle on the suspension.

FIGURE 31



IF INSTALLING NX2 OR FOX 2.0 SHOCKS SKIP TO STEP 58.

FOX 2.5 PERFORMANCE ELITE SHOCK INSTALLATION

45. Prior to the installation of the front shocks it is recommended that you trim the inner fender liner of the truck so that the installation of the reservoir and the reservoir bracket is easier.
46. On the OEM fender liner there is a seam that you will use for reference. Draw a 3" line that starts from the seam and goes towards the front of the vehicle. Using the end of the 3" line you just made, draw a line starting from the bottom of the fender liner that is 3" tall that goes towards the top of the fender liner. Draw a 7-1/2" line that starts from the center seam and goes towards the rear of the vehicle. Using the end of the 7-1/2" line you just made, draw a line starting from the bottom of the fender liner that is 3-1/2" tall that goes towards the top of the fender liner. Once you have all your lines drawn, connect the top of the 3-1/2" line and the 3" line so that you have a rectangle. (Fig. 32)

FIGURE 32

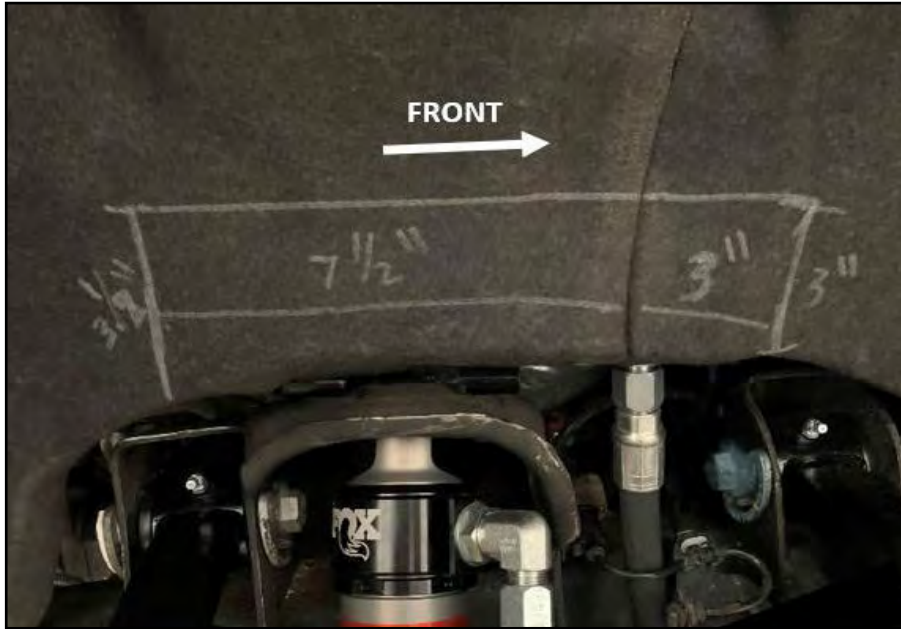

47. Now that you have your trim area drawn, trim out the rectangle (Fig. 33). Disregard the FOX shock and BDS upper control arm in Fig. 33. You will be installing them later.

FIGURE 33



48. Fox Performance Elite 2.5 shocks are an upper control arm only application, therefore the stock Upper Control Arm cannot be installed with them. Remove the upper control arm from the vehicle. Ensure that the lower control arms are supported so that they don't droop out
49. Install the FOX shock. To install the FOX shock, you will need to use the supplied hardware and reservoir mounting bracket. You should be using 1 reservoir bracket, 2 bolts, 2 nuts, and 4 washers per shock. (Fig. 34)

FIGURE 34



50. Install new shock to shock bucket on the frame. With external reservoir models, make sure that the hoses are facing outward and toward the front as shown. (Fig. 35)

FIGURE 35



51. Using the supplied hardware, attach shock to upper mounting, using a washer on both the bolt and the nut. Ensure that the reservoir bracket is between the top of the shock bucket and the supplied hardware. (Fig. 36). Torque to 90 ft*lbs.

FIGURE 36

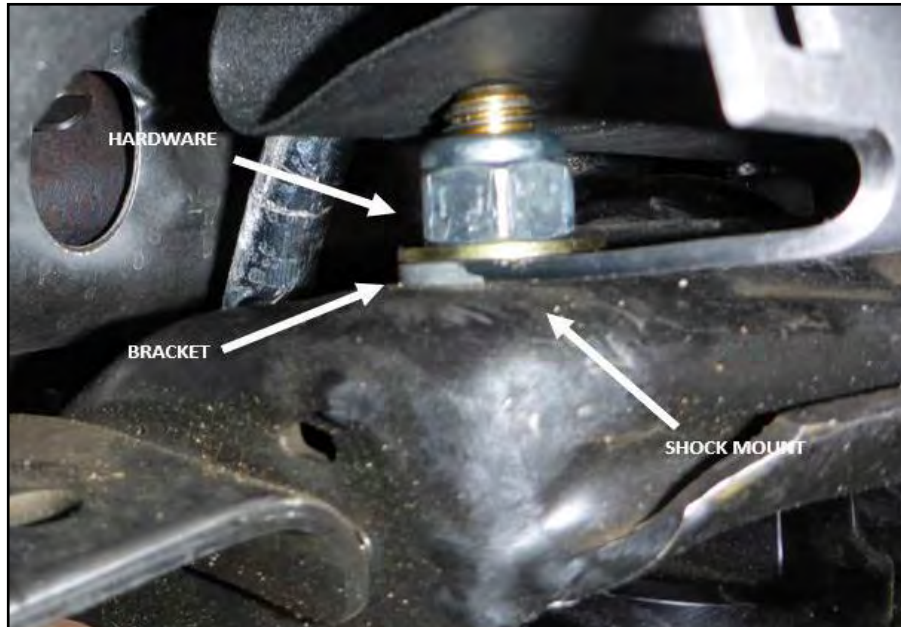

52. Swing the lower control arm up and fasten the shock to the mount on the no torsion bar drop bracket with the provided 14mm x 70mm bolt, nut, and washers (BP #587) (Fig. 37). Torque the lower shock bolt to 90 ft-lb



Tip *The bolt attaching the no torsion bar bracket to the lower control arm through the factory shock mount location may need to be loosened to install the lower shock eye. The shock bolt MUST run from front to rear for CV shaft clearance.*

FIGURE 37



53. Once the upper and lower mounting are secured, you will need to mount the reservoir. To do this, you will need to disconnect the wires/ connectors and remove the connectors from the shock bucket. There is one connector on the passenger (Fig. 38a) side, and 2 connectors on the driver side (Fig. 38b).

FIGURE 38A

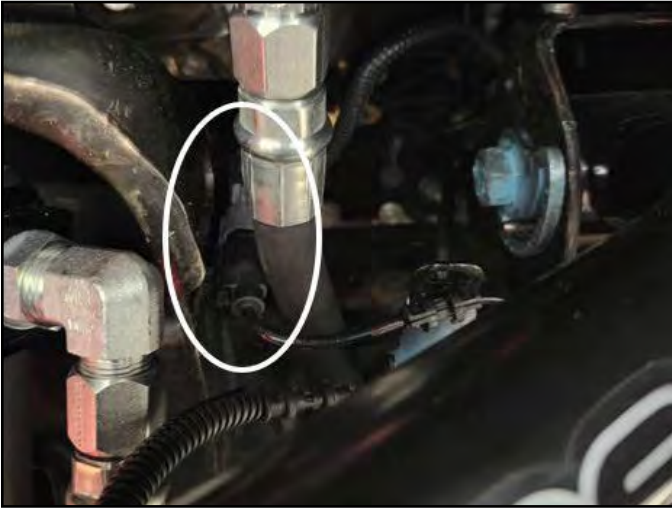

FIGURE 38B



54. Once disconnected, you can install the reservoir using the two supplied billet clamps and screws. TO mount, utilize the slots in the bracket to locate clamps. Do not feed the clamps through the slots in the brackets. Torque the (4) four socket head cap screws to 19 IN-LBS. (Fig. 39)

FIGURE 39



55. Reconnect the wires/connectors and re attach them to the shock bucket.
56. Install the BDS upper control arm according to the instructions in the upper control arm box
57. Reattach any component or hardware that was previously removed or disconnected from the vehicle. Check that suspension has proper clearance by steering in both directions. When finished it should look like Figure 33.

SKIP TO STEP 59

BDS NX2 SHOCK OR FOX 2.0 PERFORMANCE SERIES SHOCK INSTALLATION

58. Install the bushing and barpin into the upper eye of the shock (Fig. 40A). Make sure the barpin is centered in the bushing. Fasten upper bar pin to frame mount with the 1/2" bolts and a washer and nut on the top (BP #347). Torque the 1/2" bolts to 50 ft-lbs. Fasten the shock to the factory lower control arm mount on the no torsion bar drop bracket with the provided 14mm x 70mm bolt, nut, and washers (BP #587) (Fig. 40B). Torque the lower shock bolt to 90 ft-lbs.



Tip The bolt attaching the no torsion bar bracket to the lower control arm through the factory shock mount location may need to be loosened to install the lower shock eye. The shock bolt **MUST** run from front to rear for CV shaft clearance.

FIGURE 40A



FIGURE 40B



59. With the front shocks installed, torque the front shock bolt at the new torsion bar bracket to 90 ft-lbs. Apply thread locker to the main 1" bolt threads and torque the bolt to 200 ft-lbs.
60. Locate the new differential skid plate. Position the skid plate so that it aligns to holes with the welded nuts on the bottom driver's side of the rear cross member (Fig. 41). Fasten the skid plate with 1/2" x 1-1/4" bolts and 1/2" SAE washers (BP #586). Snug hardware so the front of the skid plate sets up near the bottom of the front cross member.
61. Locate the new cross member support brace (02373). The brace is formed to clear the differential actuator when installed. Position the support brace so it sets properly against the bottom of the front and rear cross members and aligned to the mounting holes. Fasten the tube to the rear cross member with a 1/2" x 1-1/4" bolt and 1/2" SAE washer (BP #586). Again, snug hardware so the brace sets up near the bottom of the front cross member (Fig. 41).

FIGURE 41



62. Locate the new front skid plate/splash guard. Loosely attach the skid plate to the original splash guard mounting holes on the upper frame cross member using the original splash guard bolts. (Fig. 42) Position the skid plate up to the bottom of the front cross member “sandwiching” the support brace and differential skid plate. Fasten the front skid plate, differential skid plate and support tube to the front cross member with 1/2” x 1-1/4” bolts and 1/2” SAE washers (BP #586) in the welded nuts in the cross member (Fig 34). Apply Thread locker to the bolt threads and torque to 55 ft-lbs.
63. Rivet on the BDS Badge to the front skid plate / splash guard (Fig 42).

FIGURE 42



64. With the front hardware tight, remove the rear bolts one at a time and apply Thread locker to the threads. Reinstall and torque to 55 ft-lbs. Torque the front factory splash guard bolts to 25 ft-lbs.
65. After all the skid plate hardware is tight, go back and torque the 4 factory lower control arm pocket bolts (mounting the new cross members) to 250 ft-lbs.
66. Locate the new steering knuckles and identify the driver's and passenger's side. Install the appropriate knuckle on the lower control arm and fasten with the original lower ball joint nut. Swing the knuckle up and attach to the upper ball joint with the original nut. Torque the upper ball joint nut to 37 ft-lbs and the lower ball joint nut to 74 ft-lbs (Fig. 43).

FIGURE 43



67. Locate the hub o-rings from the factory steering knuckle hub bores. Carefully remove the o-rings if still in the factory knuckle (Fig. 44) and install into the new steering knuckles.

FIGURE 44



68. Locate the factory driver's and passenger's brake dust shields. They need to be modified to provide adequate brake caliper clearance. Make a cut line by following the straight edge on the caliper side of the shield all the way to the bottom edge of the shield (Fig. 45). Cut the shield along the line.

FIGURE 45

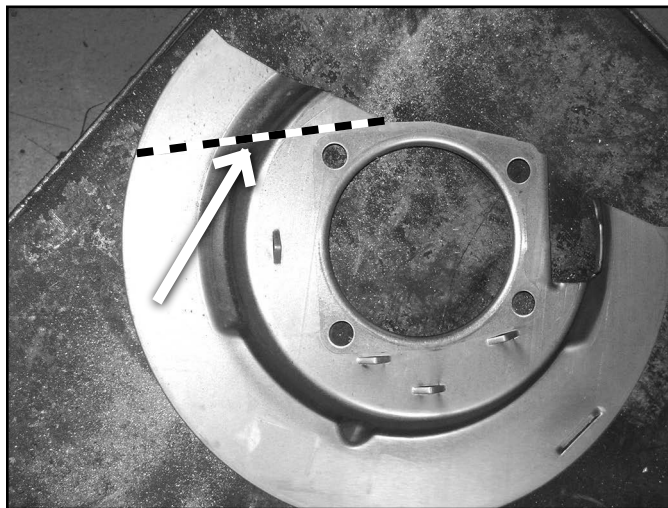

69. Install the ABS sensor into the steering knuckle using the factory bolt and thread locker (Fig. 46) Torque to 10 ft-lbs.

FIGURE 46



70. Install the hub assembly, O-rings, and dust shield into the appropriate steering knuckle (Fig. 47). Fasten the hub to the knuckle with the factory bolts. Apply thread locker to the threads and torque the bolts to 125 ft-lbs.

FIGURE 47



71. Run the ABS line around the back side of the tie rod of the steering knuckle and up to the wire connector on the frame. Reconnect the wire and reattach it to the original place on the frame. Attach the ABS line to the back side of the knuckle near the tie rod end using a wire clamp and a 1/4" x 5/8" bolt, flat washer and lock washer (BP# 877) (Fig. 48).

FIGURE 48



72. Install the torsion bar through the new torsion bar drop bracket, through the factory middle cross member and into the torsion bar keys in the torsion bar cross member. Do not load the torsion bars at this time. Check for clearance to the torsion bar and the middle cross member. Clearance out the middle cross member 1/4" in the area shown in Figure 49. Slide the torsion bar out for ease of access to grind the middle cross member for clearance.

FIGURE 49



73. Locate the factory CV axle shafts. Install the CV axle into the hub assembly (Fig. 50) and then onto the differential output flange. Align the differential flange holes and fasten with the factory bolts. Apply thread lockers to the threads and torque to 58 ft-lbs.

FIGURE 50



74. Install the original CV axle nut and washer and torque to 155 ft-lbs. Reinstall the hub dust cap.
75. Install the brake rotor on the hub by aligning the tapered retainer bolt hole in the rotor with the threaded hole in the hub flange. Fasten the rotor to the hub with the original retainer bolt and tighten securely with a T30 torx bit to 106in-lbs.
76. Locate the factory brake line junction at the frame where the hard line and rubber line meet (Fig. 51A) Using a 13mm line wrench disconnect the hard line from the rubber line. Remove the retaining clip and pull the line from the frame bracket (Fig. 51B). Place a bucket, etc under the hard line to catch any brake fluid drips.

FIGURE 51A

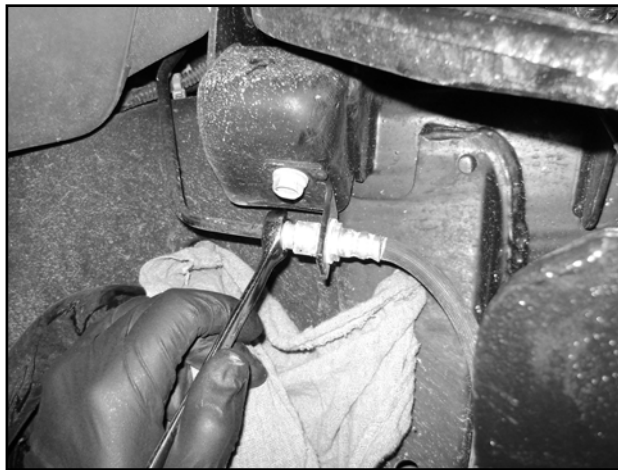
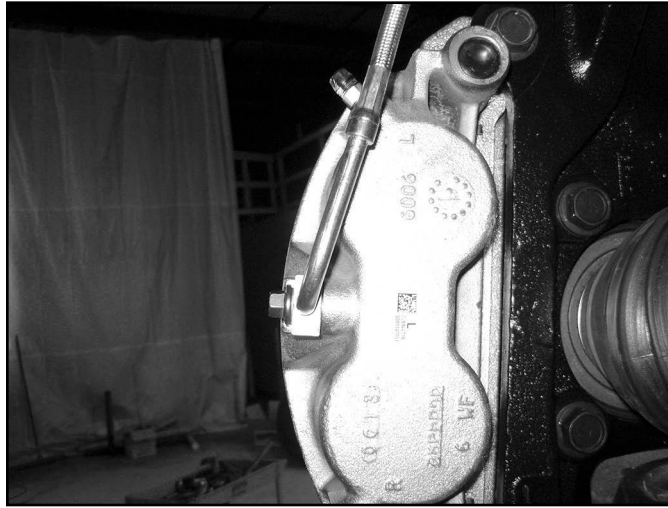

FIGURE 51B



77. With the brake lines free, install the brake calipers on the knuckles with the original bolts. Apply thread locker to the bolt threads and torque the bolts to 221 ft-lbs.
78. Locate the new provided stainless steel brake lines. The lines are driver's and passenger's side specific. The caliper end has a offset angle. When install the hard line at the caliper should point slightly inward toward the steering knuckle. Identify the appropriate lines (Fig. 52 - Drv's Side Shown).

FIGURE 52



79. Remove the factory brake line from the caliper. Be sure to remove the factory crush washers as well. Place a new provided crush washer on each face of the new brake line and install on the caliper with the factory banjo bolt. Torque the bolt to 25 ft-lbs.
80. Run the new brake line up to the factory frame mount bracket. Feed the end of the line through the bracket and fasten to the factory hard line. Using a 13mm line wrench on the hard line fitting and 11/16" wrench on the new line, tighten the fitting securely. Secure the line to the factory bracket with the original brake line clip or the provided new one (5188) (Fig. 53). When tightening be sure the brake line does not twist. It should run in a smooth arc from the caliper.

FIGURE 53



81. There are two threaded holes near the top of the steering knuckle on the back side. Using a provided wire clamp, 1/4" x 5/8" bolt, flat washer and lock washer (BP #877) loosely fasten the brake line to the lower threaded hole on the steering knuckle. Using the same fastener combination, attach the ABS line and brake sensor wire to the upper threaded hole. Pull the slack out of the line between the clamp and the caliper to provide as much loose line as possible above the clamp then tighten to lock in place. The hardware will be tightened once the line slack is set (Fig. 54A).

On the back middle of the steering knuckle there is a small threaded hole. Using a wire clamp, fasten the brake line to the knuckle with a 1/4" x 5/8" bolt and hardware (BP #877). (Fig 54B) Pull the slack out of the line between the caliper and the first clamp and tighten the hardware for the clamp to 10 ft-lbs to lock it in place. Continue to pull the slack above the top clamp on the knuckle to have as much loose brake line slack as possible for the suspension motion then tighten the top clamp hardware to 10 ft-lbs to lock it in place.

FIGURE 54A

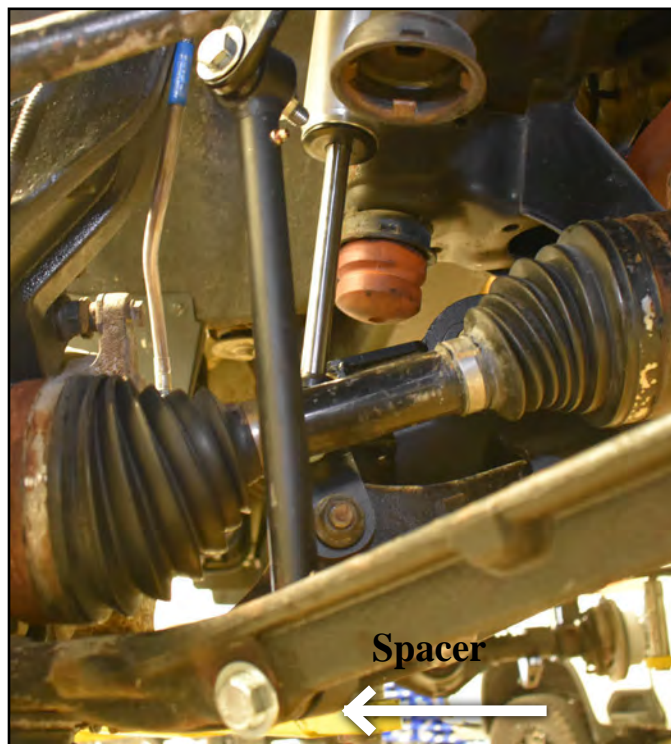

FIGURE 54B



82. Locate the new front sway bar links. Install the two sleeves into the bushings of the sway links. One sleeve will be longer than the other one. Install the poly offset spacer onto the longer sleeve. Install the longer sleeve with the poly offset spacer sandwiched between the bushing and control arm to the lower control arm on the INSIDE of the control arm using the provided 12mm x 80mm bolt, 7/16" USS Flat washer, and 12mm prevailing torque nut (BP #870) (Fig. 55).
83. Attach the upper bushing and sleeve to the sway bar using the provided 12mm x 65mm bolt, 7/16" USS Flat washer, and 12mm prevailing torque nut (BP #870). Tighten the 12mm sway bar hardware to 60 ft-lbs. (Fig. 55).

FIGURE 55



84. Attach the tie rod ends to the knuckles. The tie rod end with mount from the top down. Fasten with the original nuts and torque to 44 ft-lbs.
85. Install the torsion bar adjusting bolt retainer onto the end of the torsion key. This will keep the bolt centered on the torsion key when loaded (Fig 56). It may be necessary to grind the flashing on the parting line of the OEM key casting to get the bolt retainer to stay in place.

FIGURE 56

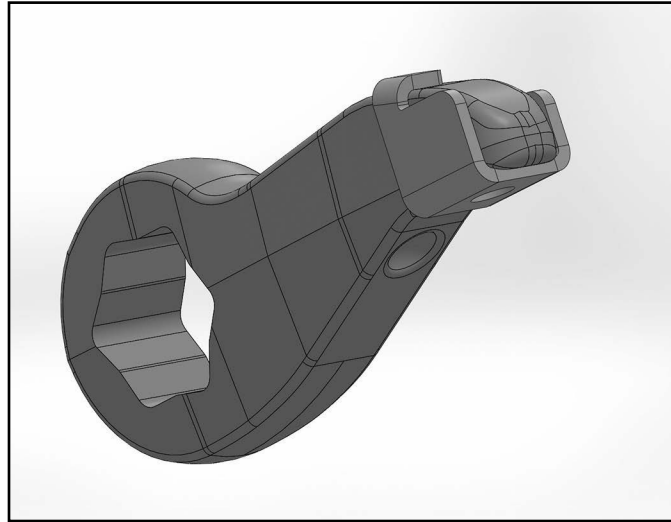

86. Load the torsion bars with the appropriate tool. Reinstall the adjuster bolt/retaining plate assembly. Reset the torsion bar adjuster bolt position to the original height measurement taken at the beginning of the installation. This adjustment will be checked/changed at the end of the installation.
87. Install the front wheels. Torque the lug nuts to 140 ft-lbs. Lower the vehicle to the ground.
88. Bounce the front end to settle the suspension.
89. Torque the lower control arm bolts (4) to 250 ft-lbs.
90. Check all front hardware for proper torque.
91. Properly bleed the entire brake system. Top off fluid. Check all brake lines for proper clearances. Adjust as necessary.
92. Check tire/wheel clearance with the fenders/bumper as well as with the steering knuckle. It is not uncommon to trim the lower plastic valance of the bumper and inner fender shroud slightly to add proper tire clearance while turning.

REAR INSTALLATION

1. Block the front wheels for safety. Raise the rear of the vehicle and support with jack stands under the frame rails, just ahead of the front leaf spring hangers.
2. Remove the wheels.
3. Raise rear of vehicle and support frame with jackstands.
4. Support the rear axle with a hydraulic jack.
5. Disconnect the two nuts attaching the brake lines to the rear differential housing. Save hardware, it will be reinstalled later (Fig. 1).

FIGURE 1

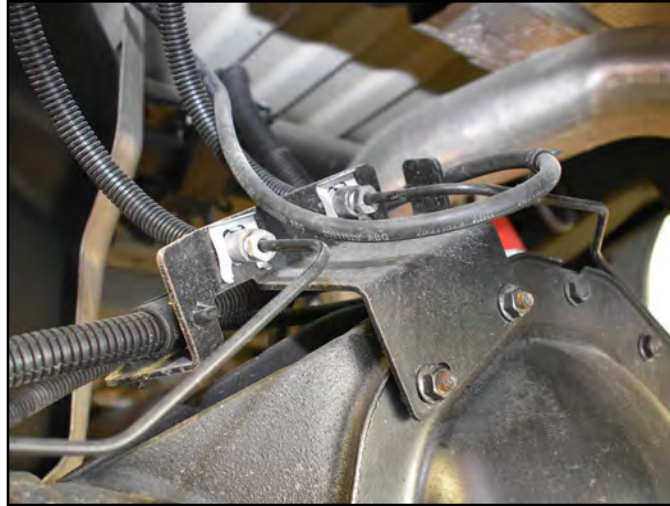

6. Remove the ABS mount from the top of the differential housing. Save hardware, it will be reinstalled later (Fig. 2).

FIGURE 2

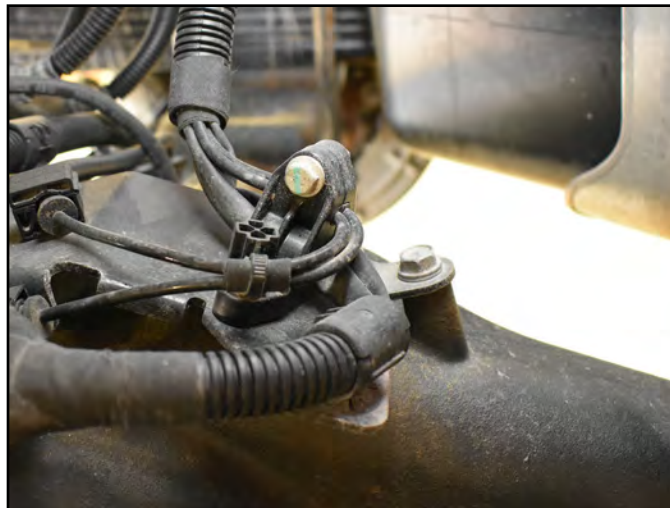

7. Remove the rear shocks. Save hardware.
8. With the axle well supported, remove the passenger's side u-bolts and lower u-bolt plate. Loosen, but do not remove the u-bolt hardware on the driver's side. This will allow the axle to move more easily and aid in installation.
9. Install the new blocks between the axle and the leaf spring. Position the block so that the bump stop wing faces inward, and the small side of the block faces forward. Align the pins/holes and raise the axle to seat the assembly. The pin will go into the REAR most hole on the block. Install the new provided u-bolts with the factory u-bolt plate (Fig. 3A/ B). Fasten with the provided locking flange nuts. Snug hardware. Final torque will be down with the vehicle on the ground.

FIGURE 3A

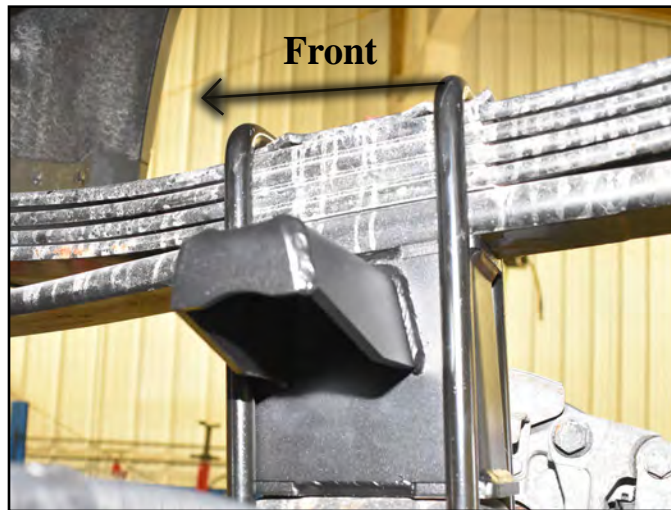

FIGURE 3B



10. Repeat block installation of the driver's side.
11. Install the rear brake line relocation bracket to the differential using the factory hardware. Using the provided 5/16" hardware (BP #873) attach the rear brake line bracket to the relocation bracket (Fig. 4).

FIGURE 4



12. Install the rear ABS line relocation bracket to the differential using the factory hardware. Using the provided 1/4" hardware (BP #873) attach the rear brake line bracket to the relocation bracket (Fig. 5). Additional wire clips may need to be undone to add enough slack for the ABS lines, use the zip ties where needed.

FIGURE 5

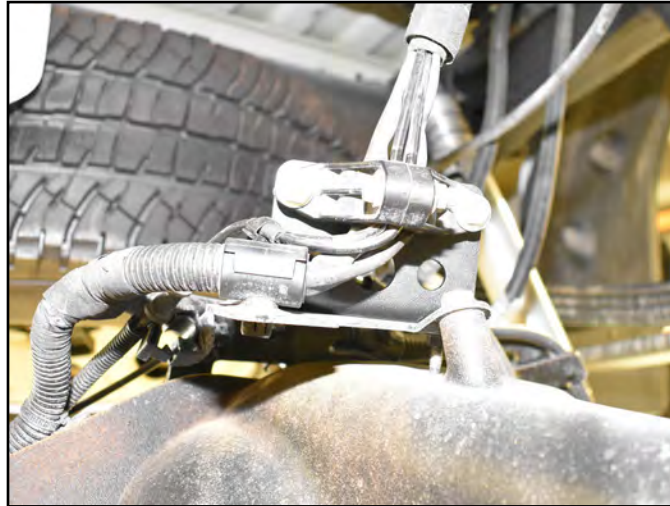

13. The passenger's side bump stop bracket on the axle must be trimmed slightly to add clearance for the new larger rear shocks. Grind the inside front corner to gain approximately 1/4" of clearance (Fig. 6). Paint bare metal to prevent rust.

FIGURE 6

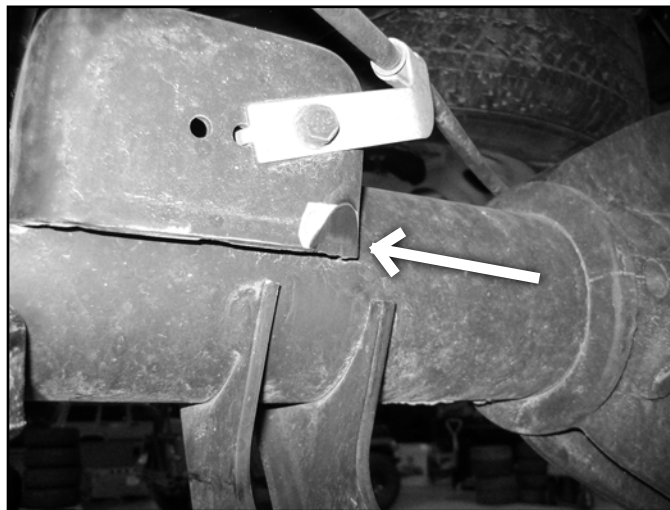

14. Install new rear shocks with the provided hardware. Fasten the shocks with the factory hardware and torque to 100 ft-lbs.
15. Check all cables for adequate slack at full droop, make adjustments if necessary.

16. Remove clips on wheels (Fig. 7). Reinstall wheels and lower vehicle to the ground. Torque u-bolts to 125 ft-lbs. Torque lug nuts to 140 ft-lbs.

FIGURE 7

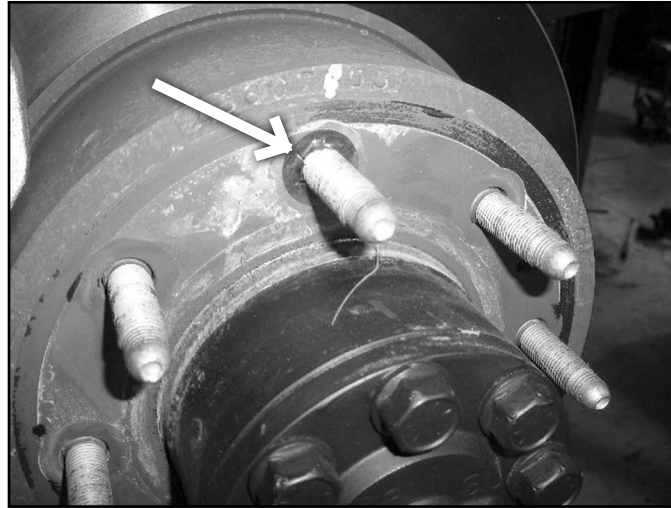

SET FRONT SUSPENSION HEIGHT

17. It is very common for the particular vehicle model to have widely varying starting suspension heights. In order to give a more precise suspension height setting we have provided a Z-height reference. Refer to Figure A

FIGURE A

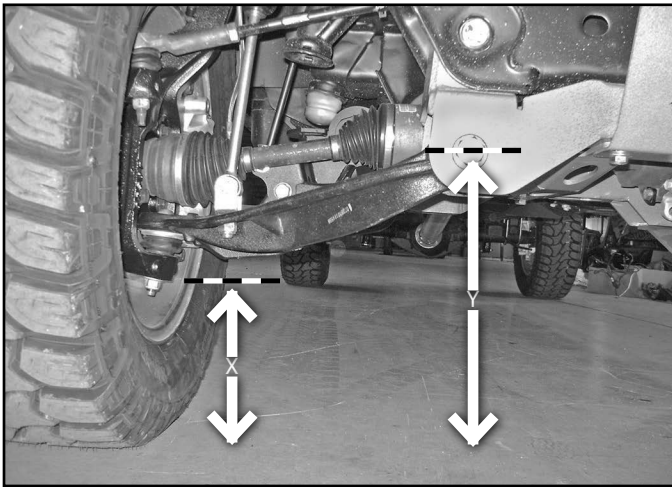
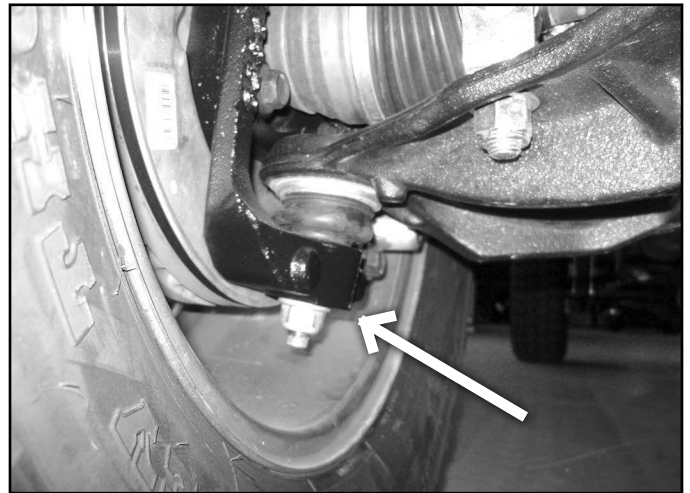

FIGURE B



18. Roll the vehicle forward and back to settle the front suspension. With the vehicle on flat, level ground measure the distance from the floor to the center of the front lower control arm bolt. This is distance 'Y'.
Record here: _____
19. Measure from the floor up to the lowest point on the new steering knuckle, near the ball joint. (Fig B). This is distance 'X'.
Record here: _____
20. 6-1/2" Kit only: To determine the Z-height use the following equation: $Y-X=Z$. For the intended 6-1/2" of lift the value for Z should be approximately 7-1/4". If your value for 'Z' is less than 7-1/4" the torsion bars need to be adjusted up (tightened). If your value for 'Z' is more than 7-1/4" the torsion bars need to be adjusted down (loosened). This should net 6-1/2" over ride height recorded at the beginning of the instructions. The 'Z' height should not exceed 7-1/4". However, this system can be run at a lower ride height down to a minimum of 5" of lift. At 5" the 'Z' height is 5-3/4". The 'Z' height should not be run below 5-3/4" with the 6-1/2" system.
21. 5" Kit only: To determine the Z-height use the following equation: $Y-X=Z$. For the intended 5" of lift the value for Z should be approximately 5-3/4". If your value for 'Z' is less than 5-3/4" the torsion bars need to be adjusted up (tightened). 'Z' height can be slightly higher than 5-3/4" if desired, but should not exceed 6-1/4" or go below 5-3/4". Set around 5-3/4" should net 5" over ride height recorded at the beginning of the instructions.

FINAL CHECK

22. Check all hardware for proper torque.
23. Reconnect the positive and negative battery cables.
24. The vehicle will need a complete front end alignment.
25. Check all hardware after 500 miles.
26. Adjust headlights.



WE WANT TO SEE YOUR RIDE!

Grab photos of your BDS-equipped truck in action and send them in for a chance to be featured. Send it in to our Bad Ass Rides customer gallery at bds-suspension.com/bar and post them on the BDS Fan Page on Facebook at facebook.com/BDSSuspensions. Don't forget about your BDS swag! BDS offers t-shirts, hoodies, decals and more available on the BDS website or through your local BDS distributor.

TIME TO HAVE SOME FUN

Thank you for choosing BDS Suspension.

For questions, technical support and warranty issues relating to this BDS Suspension product, please contact your distributor/installer before contacting BDS Suspension directly.