



Part # 11365010/11365110 - 1973-1987 GM C10 StreetGrip

Front Components

11369590	Delrin Control Arm Bushings
11369300	Drop Spindles
11362350/11362351	Front CoilSpring Kit
11369515	Front HQ Series Shocks
11369120	Front SwayBar

Rear Components

11364799	Rear Composite Leaf Springs
11365399	Delrin Leaf Spring Bushing Kit
11369510	Rear HQ Series Shocks

Recommended Tools

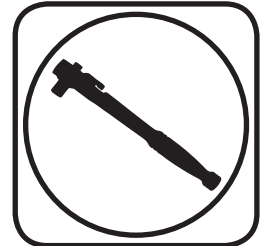

1973-1987 GM C10 Street Grip Installation Instructions

Table of contents

Page 2.....	Major Components and Hardware List
Page 3.....	Getting Started
Page 4-8.....	Delrin Bushings
Page 9.....	Drop Spindles
Page 10-11.....	Front CoilSprings
Page 12.....	Front HQ Series Shocks
Page 13-17.....	Front SwayBar
Page 17-23.....	Leaf Springs & Delrin Bushings
Page 23-27.....	Rear HQ Series Shocks

The majority of the StreetGrip components will be installed together. For example, the Front CoilSprings, Drop Spindles, Control Arm Bushings and Shocks will be installed in conjunction with each other. On the rear, the Delrin Bushings, Leaf Springs and Shocks will be installed in conjunction with each other. The front SwayBar will need to be installed **after** the rest of the front components are installed.





Major ComponentsIn the box

Part #	Description	QTY
Front StreetGrip Components		
55104200/55104201	Front CoilSprings- Small Block/Big Block	2
11364799	Rear Leaf Springs (Delrin Bushings installed)	2
90002589	Front CoilSpring Seats	2
11369300	Drop Spindles	1
11369120	Front Swaybar Kit	1
70012852	Delrin Bushing Outer Shell - Upper Control Arm	4
70012855	Delrin Bushing Outer Shell - Lower Control Arm	4
70012851	Delrin Bushing - Upper Control Arm	4
70012854	Delrin Bushing - Lower Control Arm	4
70012853	Upper Bushing Inner Sleeve	4
70012856	Lower Bushing Inner Sleeve	4
Front & Rear StreetGrip Shocks & Components		
22939999	3.850" Stroke Eye Top Shock - Front	2
22969999	5.75" Stroke Eyelet Top Shock - Rear	2
70011138	3/4" ID Shock Bushing (Installed in Shock) - Front & Rear	8
90002103	5/8" ID Shock Sleeve (Installed in Eyelet Front & Rear)	4
90002102	1/2" ID Shock Sleeve (Installed in Body Front & Rear & Mount)	6
90001617	Shock Stud	4
90002648/90002649	Rear Lower Shock Brackets - Driver & Passenger	2
Rear StreetGrip Components		
70012974	Axle Flip Bracket	2
90002667	Leaf Spring Clamping Plate	2
90002668	Shackle Assembly - (Delrin Bushings Installed)	2
90002669	Hanger Assembly - Driver	1
90002670	Hanger Assembly - Passenger	1
70012652	Delrin Leaf Spring Bushing - Front Leaf Spring (Preinstalled)	4
70012653	Delrin Leaf Spring Bushing - Rear Leaf Spring (Preinstalled)	4
70012461	Delrin Bushing - Rear Shackle (Preinstalled)	4
90002672	Inner Delrin Bushing Sleeve	6



Getting Started.....

Congratulations on your purchase of the Ridetech StreetGrip Kit. This system has been designed to give your Truck excellent ride and handling along with a lifetime of enjoyment. Some of the key features of this Kit: Dual Rate Rear CoilSprings, Delrin Control Arm Bushings with new Cross Shafts, Larger Swaybar with Delrin Liners, Drop Spindles, Longer & Relocated Panhard Bar, and C-Notches.

The majority of the StreetGrip components will be installed together. For example, the Front CoilSprings, Drop Spindles, Control Arm Bushings and Shocks will be installed in conjunction with each other. On the rear, the Delrin Bushing Kit, Leaf Springs and Shocks will be installed in conjunction with each other. The front SwayBar will need to be installed **after the rest of the front components are installed.**

Hardware Kit#99010068

The StreetGrip Kit is supplied with a hardware kit. This hardware kit contains individual bags for the different kits within the main kit. The bags are labeled to help determine the correct hardware for the installation of the specific kits. The instructions will aid you in selecting the correct hardware for each component. The bags included in this kit are:

- Front Sway Bar Kit
- Front Shock Kit
- Leaf Spring Kit
- Rear Shock Kit

Front Suspension

The front components that will need to be installed are: Delrin Control Arm Bushings, Drop Spindles, Shocks, and CoilSprings. The SwayBar needs to be installed after the rest of the front components are installed.

If you have never done this type of work before, we recommend getting a Factory Service Manual for proper procedures of disassembly and reassembly of the components for your truck.

Rear Suspension

The rear components that will be installed are rear Composite Leaf Springs with Axle Flip Kit, Delrin Leaf Spring Bushings with Shackles & Hangers, and rear HQ Series Shocks.

IT IS VERY IMPORTANT THAT NOTHING COMES IN CONTACT WITH THE COMPOSITE LEAF SPRINGS.



Part # 11369590 - 1973-1987 C10 Delrin Control Arm Bushings



Recommended Tools



1973-1987 C10 Delrin Control Arm Bushings Installation Instructions

Table of contents

Page 5.....	Included components and Hardware List
Page 6.....	Delrin Bushing Installation
Page 7.....	Upper Bushing & Control Arm Installation
Page 8.....	Upper Control Arm Bushing Shimming



Major ComponentsIn the box

Part #	Description	QTY
70012852	Upper Control Arm Bushing Outer Shell	4
70012853	Upper Bushing Inner Sleeve	4
70012851	Delrin Upper Control Arm Bushing	4
70012855	Lower Control Arm Bushing Outer Shell	4
70012856	Lower Bushing Inner Sleeve	4
70012854	Delrin Lower Control Arm Bushing	4
90002767	.100" Upper Control Arm Bushing Spacers	4

Getting Started.....

The Front Control Arms will need to be removed from the truck. Mark the shims, they will be reinstalled in the same location they were removed from. Retain the OEM hardware for reassembly. Refer to the Factory Service Manual for disassembly procedure.

This C-10 Bushing Kit contains: 4 Upper Control Arm Bushing Assemblies, and 4 Lower Control Arm Bushing Assemblies. The Upper Bushings are all the same and the Lower Bushings are the same. Be sure to match the correct Bushings with the correct locations. This kit reuses the OEM Cross Shafts.

1. Measure the Outside Width of the Control Arms and write it down before starting Bushing Removal. You will use this Dimension to check the Control Arms after the new Delrin Bushings are installed.

The Cross Shaft must be put in place and in the correct orientation before installing the Bushing Shells in the Upper Control Arms.

There are several ways the Delrin Bushing Assemblies can be installed. No matter the method used, the Control Arm needs to be **SUPPORTED** to keep from distorting the Control Arm. We recommend cutting spacers to go inside the Control Arms when pressing in the Bushings.

Note: The Delrin is self-lubricating, no lubricant is needed.

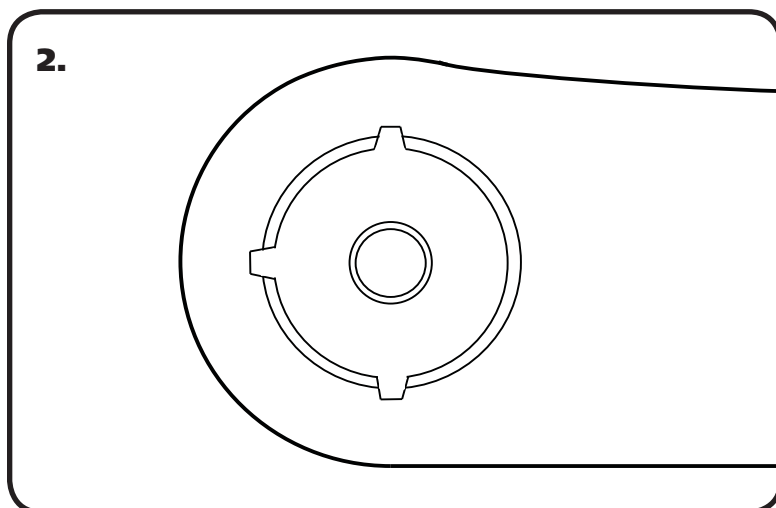

2. The OEM bushings in the Lower Control arm are staked outward. These Staked areas will need to be knocked inward to be able to remove the bushings. This can be done with a hammer and chisel. Knock the areas in far enough that they will clear the inside diameter of the bushing hole.



Delrin Bushing Installation



3. LOWER CONTROL ARM: The Lower Control Arm's Outer Shells can be installed before the Cross Shaft is installed, it will slide through the Shells. We used a C-clamp style tool to install our bushings. Most auto parts stores have these as a loan-a-tool. When pressing the Outer Shell into the arm, **be sure to support the inside of the arm to keep it from crushing.** Press the shell in until it bottoms against the control arm.



4. Insert the cross shaft into the control arm by sliding it through the Outer Shells installed in the arms. Push the Inner Sleeve into the Delrin Bushing. Push the Delrin Bushing/Inner Sleeve assembly into the Outer Shells. They will go in partially. Install the OEM washer and nut on each end of the cross shaft. Tighten the Hardware on each end until the Delrin Bushings are bottomed out against the lip of the Outer Shell installed in the control arm.



5. UPPER CONTROL ARM: The Upper Control arm has an inner washer on the cross shaft that needs to be removed before installing the Delrin Bushings.



Upper Bushing & Control Arm Installation



6. When installing the 1st Shell, use a piece of metal or strong wood to drive the Outer Shell into the Control Arm until the Shell stops. **The Shell will stop against the STEP in the Shell, not the flange, part of the Shell will be sticking out of the control arm. Install the Cross Shaft before installing the 2nd Shell.** You will need to use a piece of pipe or a deep socket to install the 2nd Shell due to the shaft sticking through. Using the pipe or socket, drive the 2nd Outer Shell in until it bottoms.



7. Push the Inner Sleeve into the Delrin Bushing. Push the Delrin Bushing/Inner Sleeve assembly into the Outer Shells. They will go in partially. Install the OEM washer and nut on each end of the cross shaft. Tighten the Hardware on each end until the Delrin Bushings are bottomed out against the lip of the Outer Shell installed in the control arm.



8. Reattach Control Arms to Truck. Use the OEM Hardware to attach the Lower making sure the Locating Pin for the lower cross shaft is in the hole. The Pin in the Cross Shaft Saddle will locate into the Holes. The Upper Control Arm Cross Shaft has a Concave area around the bolt hole. This Concave needs to go against the Convex Spacer on the Cross Shaft Bolts. The shims go behind the convex spacer. Reattach the Upper Control arms using the OEM Hardware and installing the Alignment Shims.



Shimming Upper Upper Bushings

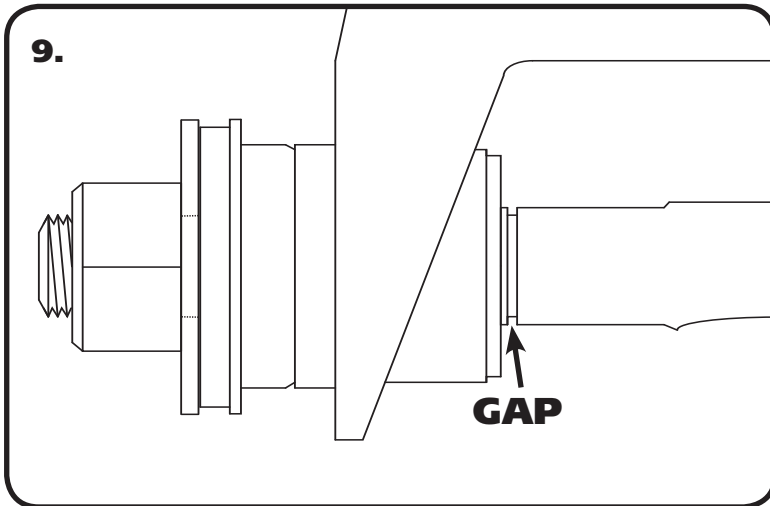

9. We have ran across variances in the width of the upper control arms. Typically .100" or .200" wider. We provide (4) .100" shims in the kit to take up the gap. When installing the shims, they need to be installed in the rear bushing. Start by loosening the rear nut and tightening the front until the cross shaft bottoms against the bushing/inner sleeve. There may be a gap between the rear inner sleeve and the cross shaft. If this gap is larger than 1/16", shimming will be required.

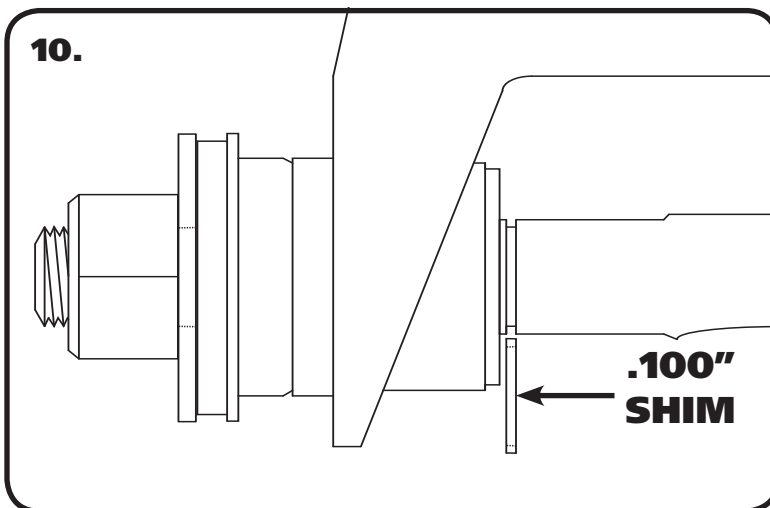

10. With the cross shaft tightened against the front bushing/inner sleeve, use the supplied shims to determine how much shim is needed to fill the gap. Typically, 1 or 2 shims will be needed. Hold the shim up to the gap to see how much is needed.

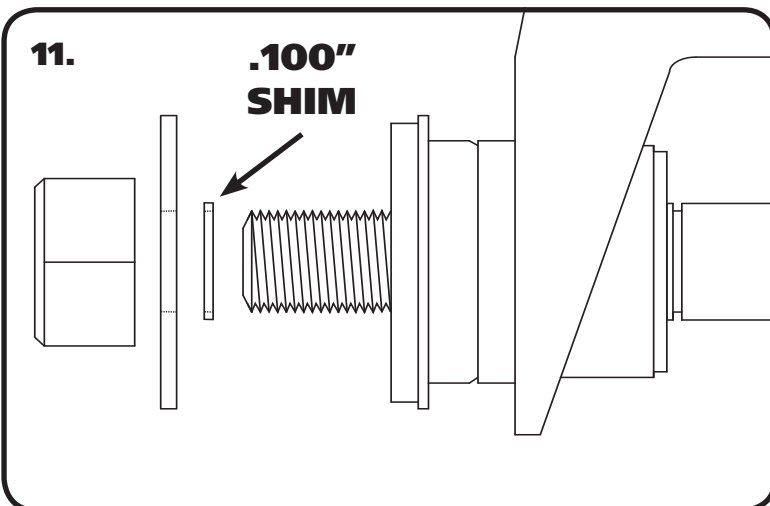

11. The nut and washer will need to be removed from the rear bushing. Slide the shim or shims onto the rear threads of the cross shaft. Install the nut and washer and tight until the washer is against the bushing. Check to see how the gap has been eliminated. If there is less than 1/16", tighten the upper cross shaft nuts to eliminate it. After the gap has been eliminated, refer to Step 8 of the previous page for control arm reattachment to the truck.



Part # 11369300 - 73-87 C10 Drop Spindles



Recommended Tools

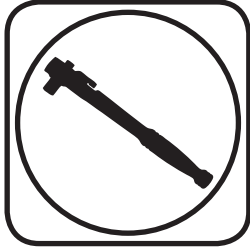

Major ComponentsIn the box

1	11369300	Pair of 63-70/71-72 drop spindles
1	90001926	Pair of caliper brackets

Installation

Balljoint nut Torque Specs:

Upper: Torque to 50 ft lbs and then tighten nut to align cotter pin hole not exceeding 90ft lbs.
Lower: Torque to 90 ft lbs and then tighten nut to align cotter pin hole not exceeding 130 ft lbs.

Note: These spindles are set up for 1973-1987 HD Rotor and Caliper. The HD Rotor is 1 1/4" wide.



Part # 11362350/11362351 - 1973-1987 C10 Front CoilSpring



Recommended Tools

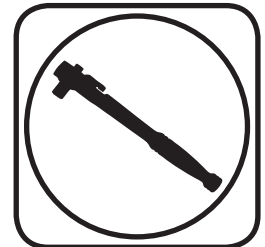

**1973-1987 GM C10 Front CoilSprings
Installation Instructions**

Table of contents
Page 11..... CoilSpring Installation

Major ComponentsIn the box

Part #	Description	QTY
55104200	Front CoilSprings	2
90002589	Front Coil Spring Seat	2
90002634	Big Block CoilSpring Spacer - BIG BLOCK ONLY	4

The Front Control Arm Bushings and Spindles should be installed before installing springs. The Front Suspension should be assembled with the Lower Balljoint disconnected from the Spindle.

The C10 StreetGrip CoilSpring utilizes an Upper Spring Seat setup. This Spring Seat setup allows the height of the truck to be adjusted by shimming the spring. Shims can be purchased through Ridetech or an authorized Ridetech Dealer.



Getting Started.....



2. The Upper Coil Spring Seat is notched for a Rivet in the OEM Seat. The Notch **MUST** be lined up with the Rivet when installing the CoilSpring/Seat Combo.



3. The CoilSpring Seat is positioned on the top of the Coil Spring with the ring inserted into the Coil-Spring. **Small Block requires NO Spacers. Big Block trucks require 2 Spacers on the Spring Seat.**

BIG BLOCK ONLY - Install 2 Spacers on each CoilSpring Seat before setting it on the Spring.

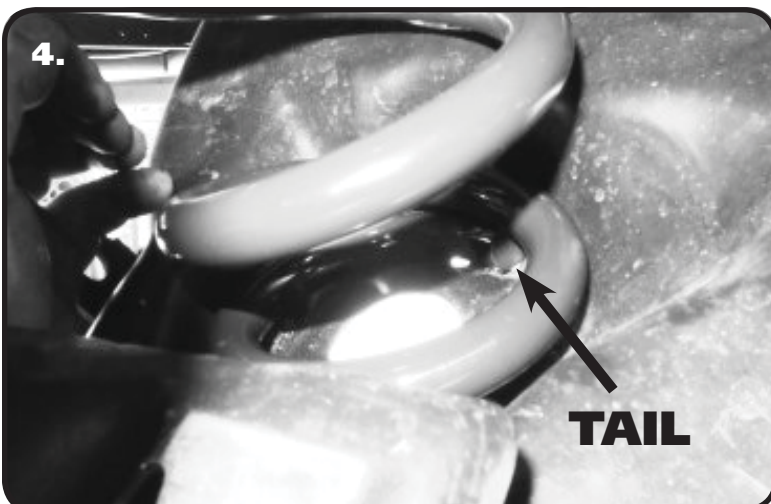

4. Insert the CoilSpring/Seat combo into the OEM coilspring pocket aligning the Rivet in the notch of the Upper Seat. Twist the spring on the Upper Seat to get the bottom of the Coil-Spring lined up with the receiver in the control arm. The end of the CoilSpring needs to be nested into the receiver area of the Control Arm. Jack the control arm up to seat the Coil-Spring and attached the bottom of the shock. With the Control Arm jacked up into position, install the bottom of the Spindle onto the Balljoint Pin. Torque the Balljoint nut to 90 ft lbs and then tighten nut to align cotter pin hole, not exceeding 130 ft lbs.



3.85" HQ Series Smooth Body Front Shocks

Major ComponentsIn the box

Part #	Description	QTY
22939999	3.85" Stroke Shock	2
70011138	3/4" ID Shock Bushing (Installed in Shock)	4
90002102	1/2" ID Shock Sleeve (Installed in Body)	2
90002103	5/8" ID Shock Sleeve (Installed in Eyelet)	2

Hardware Bag - Front Shock Kit

99501011	1/2" -20 X 2 1/4" Hex Bolt	2
99502003	1/2" -20 Thin Nylok Nut	2
99503001	1/2" Flat Washer	4

Shock Installation

1.

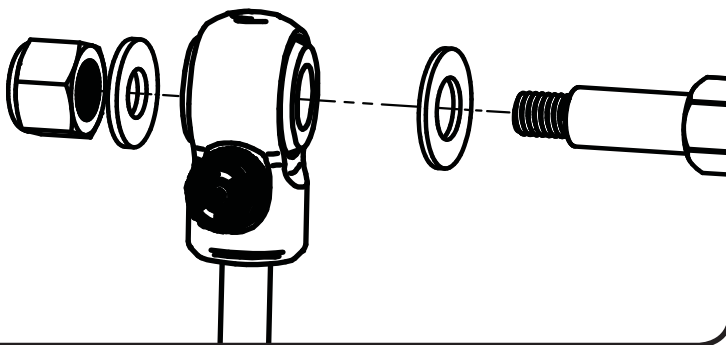

1. The Shock is supplied with 5/8" & 1/2" Sleeves. If the Sleeves are not installed, insert a 5/8" Sleeve in the shock eyelet bushing and the 1/2" Sleeve in the shock body bushing. They can be pressed in with a bench vise. Install the Eyelet of the shock on the OEM frame stud using the OEM hardware. Position the Shock with the Adjuster Knob pointing out, away from the frame.

2.



2. Attach the bottom of the Shock in the OEM location using the 1/2"-20 x 2 1/2" Bolt, Nut & Flat Washers supplied in the kit. The Lower Shock is Bolted to the Lower OEM Mount using the supplied Shock Sleeve.



Part # 11369120 - 1973-1987 C10 Front SwayBar



Recommended Tools

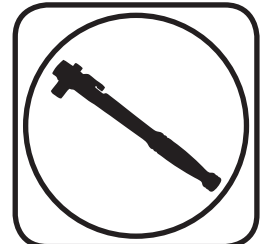

1973-1987 C-10 Front SwayBar Installation Instructions

Table of contents	
Page 13.....	Included Components and Hardware List
Page 14.....	Getting Started
Page 15-17....	SwayBar Installation

Install all Front StreetGrip Components before installing the SwayBar.

Major ComponentsIn the box

Part #	Description	QTY
90002590	Front SwayBar	1
90002592	End Link Kit	1
70012401	Delrin Sway Bar Bushing Liner	2
90002513	Bushing Strap	2
90001099	SwayBar Bushing	2
90002591	SwayBar Mounting Bracket	2
90002593	Control Arm Mounting Tabs	2

Hardware Bag - Front Sway Bar Kit

Part #	Description	Usage	QTY
99371004	3/8"-16 x 1 1/4" Hex Bolt	Frame & Control Arm Mount	12
99372002	3/8"-16 Nylok Nut	Frame & Control Arm Mount	12
99373003	3/8" SAE Flat Washer	Frame & Control Arm Mount	24



Getting Started.....



1. Some trucks are equipped with a sway bar. If your truck has one, the OEM mount will need to be removed to install the Street-Grip Sway Bar. This is done by removing the rivets. The rivets can be removed by chiseling the heads off and driving them out or by drilling the rivets out. The new Frame Mount bolts directly in place of the old mount. If your truck doesn't have a sway bar, the mounting holes will still be in the frame.

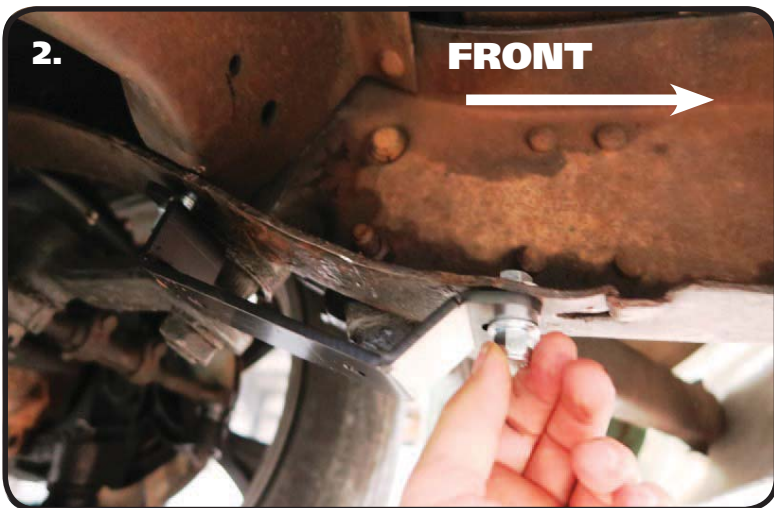

2. The Sway Bar Mount attaches to the frame using the holes from the OEM mount. The end of the frame bracket with the angled bends goes forward. Attach the bracket using a 3/8"-16 x 1 1/4" bolt, 3/8"-16 Nylok nut and a 3/8" Flat Washer on top and bottom. The same hardware setup is used in each hole. Repeat on the other side and tighten hardware.



3. The Delrin Liner is split on one side to ease installation. We found it easier to install by opening up the Liner enough to slide it onto the end of the SwayBar, then sliding it into position. It will open up and slide over the curves in the Bar. Install a Liner on each side of the SwayBar in the approximate location they will need to be when installing the SwayBar on the Truck.

Note: The Delrin is self-lubricating, no lubricant is needed.



SwayBar Installation



4. Open up the Poly SwayBar Bushings and install them over the Delrin Sleeves.



5. Install Bushing Straps Over the Poly Sway-Bar Bushings.



6. Hold the SwayBar into position on the truck with the SwayBar arms below the tie rods. Align the holes in the Bushing Straps with the holes in the Frame Brackets. Install a 3/8" Flat Washer on (4) 3/8"-16 x 1 1/4" Hex Bolts and insert them into the holes. Install a 3/8" Flat Washer and 3/8"-16 Nylok Nut on each Bolt. Center the bar in the bushings before snug-ging up the hardware. Do **NOT** completely tighten the Hardware. It will be left partially loose until the End Links are installed.



SwayBar Installation

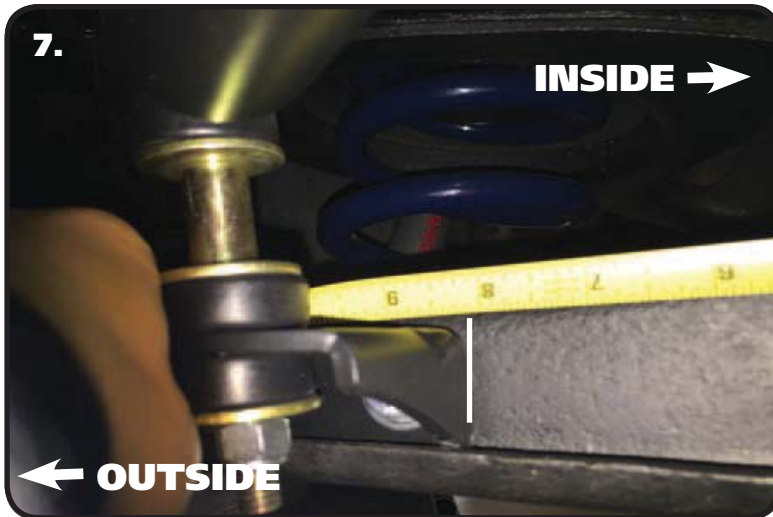

7. This kit requires a Bracket to be installed on the control arm for the sway bar linkage. The Bracket needs to be positioned with the inside edge 8" from the CONTROL ARM BUSHING and the ears pointing DOWN. Hold the end of the tape measure against the outer edge of the Control Arm Bushing and make a mark on the Control Arm at 8". Hold the Bracket on the Control Arm with the ears pointing DOWN and against the lip of the control arm. Use the bracket to mark and drill the mounting holes to 3/8".



8. Install a 3/8" Flat Washer on (2) 3/8"-16 x 1 1/4" Hex Bolts and insert them into the holes. Install a 3/8" Flat Washer and 3/8"-16 Nylok Nut on each Bolt. Repeat on the other side and tighten hardware.

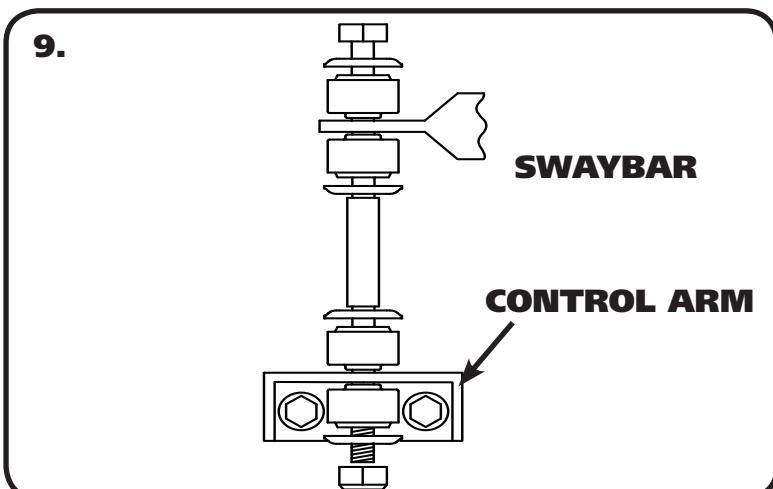

9. Install the End Links. Use **Image 9** for proper installation. Tighten the Hex Nut enough to slightly compress the Bushings.

10. Tighten the Sway Bar Mounting Hardware.



Part # 11364799/11365399 - 1973-1987 GM C10 Composite Leaf Springs & Delrin Bushings



Recommended Tools



1973-1987 GM C10 Composite Leaf Springs & Delrin Bushings

Installation Instructions

Table of contents

Page 18.....	Included components and Hardware List
Page 19.....	Bump Stop Installation
Page 20.....	Rear Hanger Installation
Page 21-23.....	Leaf Spring Installation

IT IS VERY IMPORTANT THAT NOTHING COMES IN CONTACT WITH THE COMPOSITE LEAF SPRINGS.





Major ComponentsIn the box

Part #	Description	QTY
70012407	Leaf Spring Blade (Blade Assembly)	2
70012458	Leaf Spring Eyelet (Blade Assembly)	4
99251015	1/4"-20 x 1 3/4" Flange Bolt (Blade Assembly)	12
99252004	1/2"-20 Flange Nut (Blade Assembly)	12
90002711	Axle Flip Bracket	2
90002667	Leaf Spring Clamping Plate	2
90002640	Bump Stop	2
90002668	Leaf Spring Shackle Assembly	2
90002669	Leaf Spring Hanger Assembly - Driver	1
90002670	Leaf Spring Hanger Assembly - Passenger	1

Hardware Bag - Leaf Spring Kit

Part #	Description	Usage	QTY
99431002	7/16"-14 x 1 1/4" Hex Bolt	Hanger to Frame	8
99433002	7/16" Flat Washer	Hanger to Frame	16
99432001	7/16"-14 Nylok Nut	Hanger to Frame	8
99561011	9/16"-12 x 4 1/2" Hex Bolt	Leaf Spring Bushings	6
99562006	9/16"-12 Nylok Nut	Leaf Spring Bushings	6
99563003	9/16" Flat Washer	Leaf Spring Bushings	12

Getting Started.....

THE COMPOSITE LEAF SPRINGS COME WITH THE RIDETECH DELRIN BUSHINGS INSTALLED.

IT IS VERY IMPORTANT THAT NOTHING COMES IN CONTACT WITH THE LEAF SPRING.

The OEM leaf spring setup has the rear differential under the leaf springs. The Ridetech Composite Leaf Spring Kit relocates the axle to the top side of the leaf springs. An Axle Flip Bracket is included in the kit to relocate the differential.

1. Jack the truck up and support it by the frame rails. You will need to raise and lower the rear differential with a jack to ease installation. With the truck supported by the frame, put the jack underneath the rear end housing and raise the jack up just enough to support the differential. Disconnect the bottom of the shock and remove the rear leaf springs. Retain the OEM hardware.
2. This kit requires the removing of the OEM bump stop bracket and also the rear leaf spring hanger. A new hanger is supplied in the kit.
3. The rear Hanger/Shackle will need to be installed before the Leaf Spring can be installed. .



Delrin Leaf Spring Bushing Installation



3. The OEM bump stop and brackets need to be removed from the frame. Do this by cutting the rivet heads off and driving them out or drilling the rivets out. Remove the driver and passenger brackets.

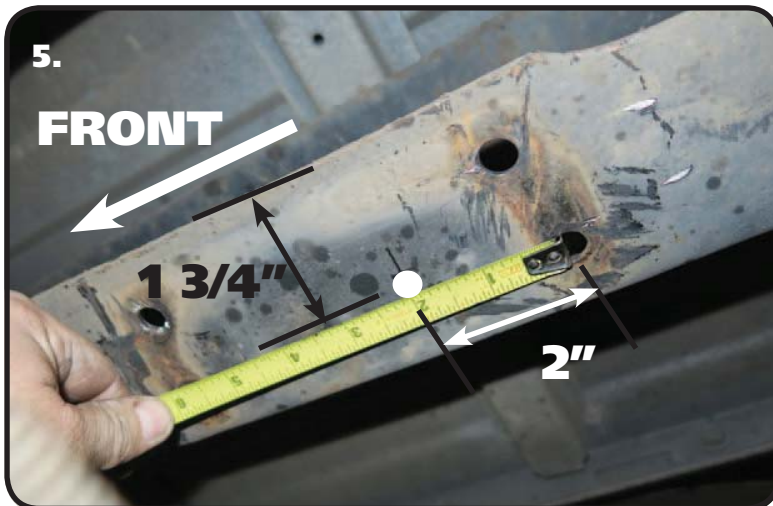

5. Once the bump stop mount is removed, a new hole will need to be drilled for the included Bump Stop. Mark the hole 2" from the REAR OUTER rivet hole and 1 3/4" from the INNER Edge of the frame. Mark this location and drill with a 3/8" drill bit.



6. Install the Bump Stop using a 3/8" Flat Washer & 3/8"-16 Nylok Nut. Hold the Bump Stop with your hand while tightening the nut.



Rear Hanger Mount Installation



7. The rear leaf spring hanger will need to be removed from the frame and replaced with the one included in the StreetGrip Kit. This can be done by cutting a "+" in the head of the rivet and chiseling it off. With the head removed, you can drive the rivet out. The rivets can also be drilled out.

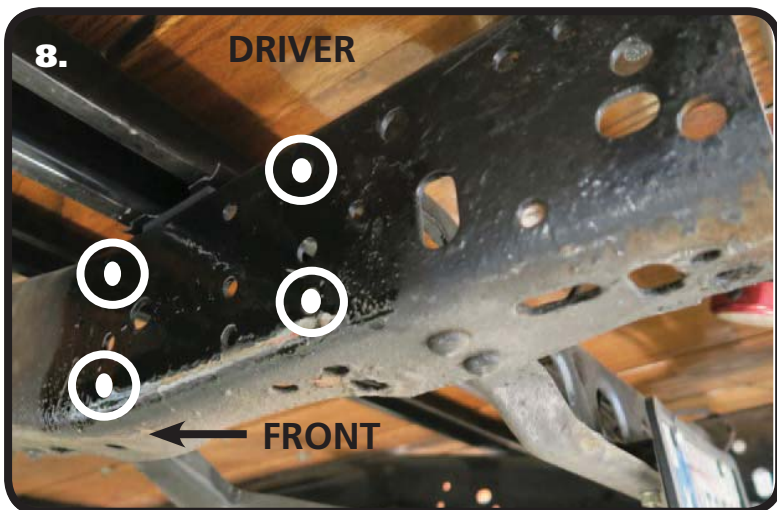

8. The rear of the frame has 2 sets of Hanger Mounting Holes, this Kit uses the FRONT set. The Driver side is shown in **Image 8**. Drill the (4) front Hanger mounting holes to 7/16".

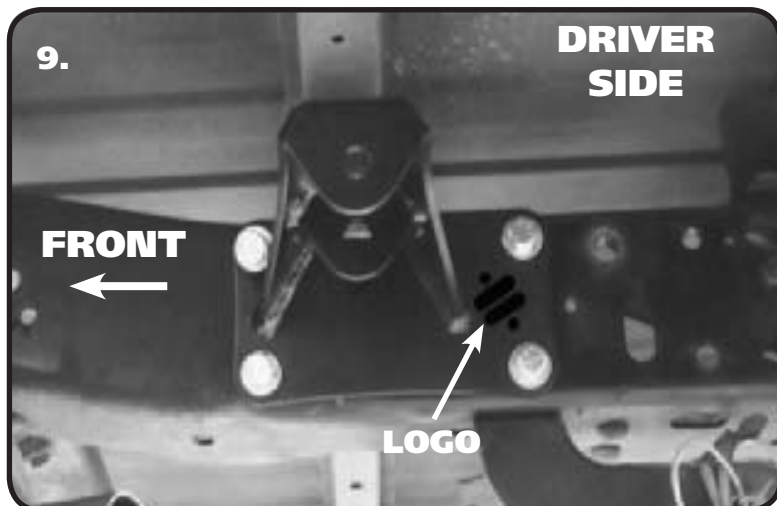

9. The Kit includes new Rear Leaf Spring Hangers. There is a Driver and Passenger Rear Hanger. The Hangers get mounted with the Logo to the rear and the Tabs pointing down. Install a 7/16" Flat Washer on (4) 7/16"-14 x 1 1/4" Hex Bolts. Hold the correct Hanger Bracket on the side of the frame aligning the (4) holes with the (4) FORWARD hanger mounting holes. The 2 Ears on the Hanger need to be pointing down with the Logo to the rear as seen in **Image 9**. Insert the Bolt/Washer assembly through each of the holes. Install a 7/16" Flat Washer & 7/16"-14 Nylok Nut on the Bolt Threads sticking through the frame. Tighten the Hardware to 50 ftlbs. Repeat steps 7-9 on the opposite side.



Leaf Spring Installation



4. Install the Shackle, with the OPEN side to the FRONT, by sliding it up into the tabs lining up the inside of the sleeve with the holes in the tabs. Install a 9/16" Flat Washer on a 9/16"-12 x 4 1/2" Bolt supplied in this kit. Insert the Bolt/Washer through the Hanger & Shackle. Install a 2nd 9/16" Flat Washer & 9/16"-12 Nylok Nut on the Threads sticking through. DO NOT tighten the 9/16" Hardware until the Leaf Springs are installed. Attach the rear of the Composite Leaf Spring (**SMALLER BUSHING**) to the Shackle. Insert the Leaf Spring into the Shackle, lining up the holes. Install a 9/16" Flat Washer on a 9/16"-12 x 4 1/2" Bolt supplied in this kit. Insert the Bolt/Washer through the Shackle & Leaf Spring. Install a 2nd 9/16" Flat Washer & 9/16"-12 Nylok Nut on the Threads sticking through.



5. The Flip Bracket has a TALL narrow Tab sticking up past the wider Tab on one end. This taller Tab goes to the rear of the truck. Some 12 bolt differentials require the narrow tab to be cut off even with the wide tab. You will need to check if the tab needs cutoff. Do this by holding the flip bracket in position against the bottom of the leaf spring bracket. With the bracket held in position, check to see if the axle tube sits against the bottom of the saddles. If there is a gap, the tab will need cut off. It can either be cut off or ground down even.



6. Place the Flip Bracket on TOP of the Leaf Spring lining up the Hole in the Bracket with the Locating Pin on the Leaf Spring. The ears of the Flip Bracket point up toward the frame. If it's a 10 bolt differential, the tall tab goes to the rear. If it's a 12 bolt differential, the tall tab gets cut off even.



Leaf Spring Installation



6. Swing the front of the Leaf Spring up into the front Hanger aligning the Differential with the Flip Bracket. It may be necessary to raise the Differential up to get the Leaf Spring into the front hanger. Align the holes in the Hanger with the Bushing Sleeve. Install a 9/16" Flat Washer on a 9/16"-12 x 4 1/2" Bolt supplied in this kit. Insert the Bolt/Washer through the Hanger & Leaf Spring. Install a 2nd 9/16" Flat Washer & 9/16"-12 Nylok Nut on the Threads sticking through.



7. Lower the Differential down into the Flip Brackets. The Tabs that stick up will rest against the OEM leaf spring mount. This keeps the axle from slipping in the Bracket.



9. Slide the OEM U-bolts onto the Axle Tube with the threads pointing DOWN. Slide the Clamping Plate onto the U-bolts with the Bent Tabs pointing DOWN aligning the Locating Pin on the Leaf Spring with the center hole on the Clamping Plate. Install the OEM Flat Washers and Nuts onto the U-bolts. When tightening the hardware, make sure the Locating Pin stays in the center hole of the plate. Evenly tighten the hardware by tightening in a crisscross fashion. Torque the U-bolt hardware to 55 ftlbs.



Leaf Spring Installation

Note: When tightening the mounts, pay attention to the pads on the springs to make sure there is visible compression of the pads. .030"-.060" of compression is needed for the springs to be securely mounted. All of the clamping force needs to be on the spring itself.

9. Tighten the Bushing hardware, torquing it to 75 ftlbs. The Delrin Bushings will not bind, so it isn't necessary to have the car at ride height. If using OEM style rubber bushings, the car will need to be on the ground at ride height before tightening the bushing hardware.

10. Install the Ridetech HQ Series shocks. Refer to the shock instructions.

11. **DOUBLE CHECK TO MAKE SURE NOTHING IS COMING INTO CONTACT WITH THE LEAF SPRING.**

Part # 11369510 - 1973-1987 C10 Rear Shock Kit



Recommended Tools

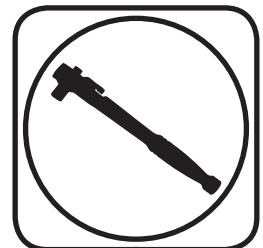

HQ Series Rear Shock Kit Installation Instructions

Table of contents

Page 24.....	Components
Page 25.....	Getting Started
Page 26-27.....	Attaching Shock & Shock Adjustment



5.75" HQ Series Smooth Body Shocks

Major ComponentsIn the box

Part #	Description	QTY
22969999	5.75" Stroke Shock	2
70011138	3/4" ID Shock Bushing (Installed in Shock)	4
90002103	5/8" ID Shock Sleeve (Installed in Shock Eyelet)	2
90002102	1/2" ID Shock Sleeve (Installed in Shock Body) 2 for Lower Mount	4
90002648	Lower Shock Mount Bracket - Driver	1
90002649	Lower Shock Mount Bracket - Passenger	2
90001617	Shock Stud Kit	2

Hardware Bag - Rear Shock Kit

Part #	Description	Usage	QTY
99431002	7/16"-14 x 1 1/4" Hex Bolt	Lower Shock Mount to Axle	2
99433002	7/16" Flat Washer	Lower Shock Mount to Axle	4
99432001	7/16"-14 Nylok Nut	Lower Shock Mount to Axle	2
99501011	1/2"-20 x 2 1/2" Hex Bolt	Mount to Axle	2
99501010	1/2"-20 x 2 1/4" Hex Bolt	Shock to Lower Mount	2
99503001	1/2" Flat Washer	Shock to Lower Mount	4
99502003	1/2"-20 Thin Nylok Nut	Shock to Lower Mount	4

The Rear Shocks will be installed in conjunction with the Rear Leaf Springs and Delrin Bushing Kit.

Getting Started.....

1. Jack the truck up and support it by the rear differential at first to determine the correct shock mount for the drivers side. After you determine the correct driver shock mount, you will need to raise the truck up and support it by the frame to hook attach the bottom of the shocks. **Steps 3 & 4** will help you which shock mount to use on the driver side. Unbolt the bottom of the shock and disconnect it. Remove the nut from the upper shock stud.

2. Remove the old shocks from the truck.



Getting Started.....

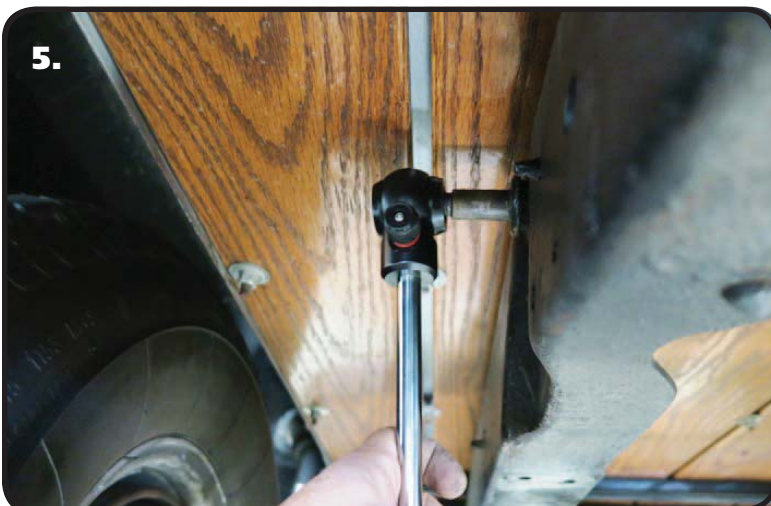

3 & 4. The kit comes with 3 rear shock mounts. 2 of them are stamped "P" for passenger, 1 is stamped "D" for driver. Do to variations in the truck, it is sometimes necessary to use a passenger mount on the drivers side. You need to determine which Shock Mount is going to be required on the Driver Side. The Passenger side will always use a Mount stamped with a "P". With the truck supported by the rear axle or sitting on the ground, measure the shock mounting length dimension of the OEM mounts. If it measures around 14 3/4", you will need to run a passenger mount on the driver side. With the shock mount installed, the shock should measure around 13 3/4" center to center. If you would run the Driver mount, the shock would measure less than 13" center to center. Image 4 illustrates how much shorter the shock would be if you installed a Driver mount when a Passenger is needed.

5. This Kit includes new upper Shock Studs to replace the existing ones. Replace the Studs and install the eyelet of the Shock on the Stud. The passenger shock gets installed with the Knob forward, install the driver with the Knob to the rear. Once the Shock is installed on the Stud, install a 7/16" Flat Washer & 7/16-20 Nylok Nut on each Stud and tighten.



Attaching Shock & Adjustment

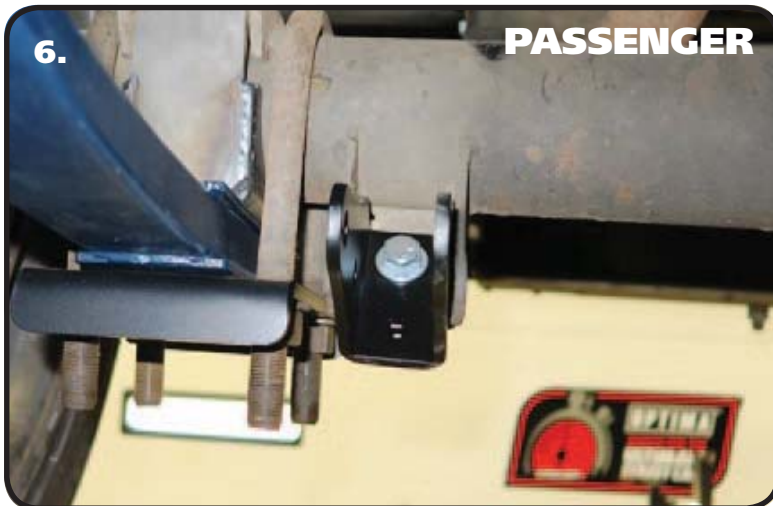

6. Slide each bracket into their correct OEM shock mounts. The brackets will bottom out against the back of the OEM bracket with the OEM shock mounting holes lining up with holes in the bracket. Install a 7/16" Flat Washer on a 7/16"-14 Bolt and insert it through the back of the bracket. It will go through the back of Shock Bracket and a hole in the OEM mount. With the Bolt/Washer in place, install a 2nd 7/16" Flat Washer on the bolt followed by a 7/16"-14 Nylok Nut. Do this for both sides. DO NOT TIGHTEN YET.

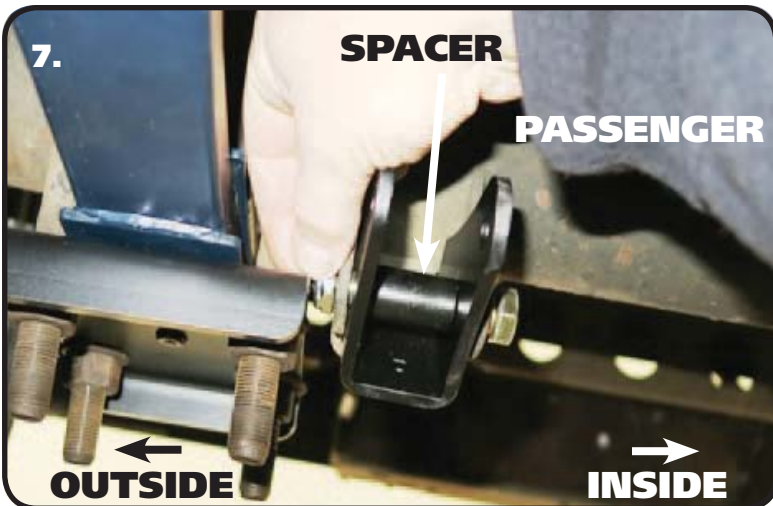

7. The kit includes a spacer that goes inside the New Bracket. Install the 1/2" ID spacer into the Bracket lining it up with the OEM shock holes and holes in the Bracket. Insert a 1/2"-20 x 2 1/2" Bolt through the lined up holes with the THREADS TOWARD THE WHEEL. Install a 1/2"-20 THIN Nylok Nut. Do this for both Shock Mounts. Tighten the 1/2" & 7/16" Hardware on both mounts.



8. Slide the bottom of the Shock into the new Mount. Line up the Shock with the Mounting Hole in the Lower Mount. You may need to jack up the differential to get the holes lined up. Install a 1/2" Flat Washer on a 1/2"-20 x 2 1/4" Bolt. Insert the Bolt/Washer into the Mount/Shock. Install a 1/2"-20 THIN Nylok Nut on the threads sticking through. Do this for both sides and tighten hardware.



Shock Adjustment

Shock adjustment 101- Single Adjustable

Rebound Adjustment:

How to adjust your new shocks

The rebound adjustment knob is located on the top of the shock absorber protruding from the eyelet or stud top. You must first begin at the ZERO setting, then set the shock to a street setting of 12 or handling setting of 8.

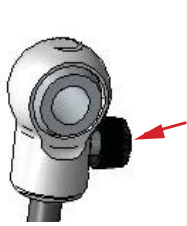

-Begin with the shocks adjusted to the ZERO rebound position (full stiff). Do this by rotating the rebound adjuster knob clockwise until it stops.



-Now turn the rebound adjuster knob counter clockwise 12 clicks. This sets the shock at 12 for a street setting. If you are after a handling setting only go 8 clicks.

Take the vehicle for a test drive.

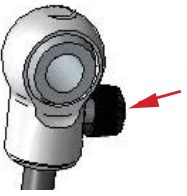

-if you are satisfied with the ride quality, do not do anything, you are set!

-if the vehicle is too soft increase the damping effect by rotating the rebound knob clockwise 3 additional clicks.

-If the vehicle is too stiff rotate the rebound adjustment knob counter clock wise 2 clicks and you are set!

Take the vehicle for another test drive and repeat the above steps until the ride quality is satisfactory.

Note:

One end of the vehicle will likely reach the desired setting before the other end. If this happens stop adjusting the satisfied end and keep adjusting the unsatisfied end until the overall ride quality is satisfactory.