

TERMINATOR™

STEALTH *EFI*



550-442 EFI Throttle Body w/ GM Trans Control - Polished

550-443 EFI Throttle Body w/ GM Trans Control – Hard Core Gray

FUEL INJECTION INSTALLATION MANUAL

Read this manual before using this product.

WARNING!

This instruction manual must be read and fully understood before beginning installation. If the instructions are not fully understood, installation should not be attempted. Failure to follow the instructions may result in subsequent system failure and could result in serious personal injury and/or property damage. Keep this manual.

For the safety and protection of you and others as well as your vehicle, only a trained mechanic having adequate fuel system experience should perform the installation, adjustment, and repair.

While undertaking any work involving the fuel system, it is particularly important to remember one of the very basic principles of safety: fuel vapors are heavier than air and tend to collect in low places where an explosive fuel/air mixture may be ignited by any spark or flame resulting in property damage, personal injury, and/or death. Extreme caution must be exercised to prevent spillage and thus eliminate the formation of such fuel vapors. All work involving this product and the fuel system generally **MUST** be performed in a well-ventilated area. Do NOT smoke or have an open flame present near gasoline vapors or an explosion may result.

Any components damaged due to failure to follow these instructions will not be covered by the warranty. Failure of any one component does not constitute, nor does it justify, warranty of the complete system. Individual service items are available for replacement of components. If assistance is required or if you need further warranty clarification, please call Holley Technical Service at 1 (270) 781-9741.

TABLE OF CONTENTS:

1.0 INTRODUCTION & SYSTEM REQUIREMENTS	3
1.1 Engine Requirements	3
1.2 Fuel System Requirements	3
2.0 PARTS IDENTIFICATION	4
3.0 TOOLS REQUIRED FOR INSTALLATION	6
4.0 OXYGEN SENSOR INSTALLATION	6
5.0 COOLANT TEMPERATURE SENSOR INSTALLATION	7
6.0 THROTTLE BODY & CABLE BRACKET INSTALLATION	7
6.1 Throttle Connections	8
6.2 Vacuum Line Connections	8
7.0 FUEL SYSTEM	9
8.0 ECU MOUNTING AND WIRING OVERVIEW	9
9.0 WIRING HARNESS INSTALLATION	9
9.1 Harness Routing	10
9.2 Sensor Connections & Loose Wires	11
10.0 IGNITION WIRING	11
11.0 ADDITIONAL OUTPUTS	15
12.0 TRANSMISSION WIRING	16
13.0 PREVIOUS INSTALLATION REQUIRED	17
14.0 TERMINATOR™ INSTRUCTIONS AND TUNING	17
15.0 INITIAL POWER-UP	17
16.0 HANDHELD NAVIGATION & USE	18
16.1 Making Adjustments	18
17.0 HOME SCREEN	18
18.0 CALIBRATION WIZARD	18
19.0 TPS AUTOSET	20
20.0 TRANSMISSION SETUP	21
20.1 Transmission	21
20.1.1 Trans Setup	21
20.1.2 Speed Calc	21
21.0 SENSOR VERIFICATION	22
22.0 STARTUP	22
23.0 SETTING IGNITION TIMING	23
24.0 AFTER-STARTUP	23
25.0 IDLE SETTING/THROTTLE PLATE SETTING	23
26.0 SELF-TUNING	24
27.0 GAUGE SCREENS	24
27.1 Monitor	24
27.1.1 Multi-Gauge	25
27.1.2 Monitors	25
27.1.3 Diagnostics	26
28.0 Custom Setups	26
28.1 Dash Setup	26
28.2 Channels Scaling	27
29.0 FILE SAVING/LOADING	27
29.1 File	27
29.1.1 ECU Overview	28
29.1.2 ECU Globals	28
29.1.3 ECU Data Logging	29
29.1.4 ECU Hardware/Firmware (HW/FW)	29
29.1.5 Local Setup	29
30.0 BASIC TUNING	30
30.1 Basic Fuel	31
30.1.1 Target AFR	31
30.1.2 Acceleration Enrichment	31
30.1.3 Fuel Prime	32
30.2 Fuel Learn	32
30.2.1 Learn Enable/Disable	32
30.2.2 Learn Speed	33
30.3 Basic Idle	33
30.4 Spark	34
30.5 Transmission	34
30.5.1 Shifts	34
30.5.2 WOT Shifts	35
30.5.3 Torque Converter Clutch (TCC) Parameters	36
30.5.4 Torque Converter Clutch (TCC) (Un) Lock	36
30.5.5 Line Pressure	37
31.0 SYSTEM SETUP	37

31.1 System Tuning	37
31.1.1 Outputs	38
31.1.2 Engine Setup	38
31.1.3 Ignition Setup	39
32.0 ADVANCED TUNING	40
32.1 Advanced Fuel	40
32.2 Closed Loop	40
32.3 Advanced Learn	41
32.3 Advanced Idle	42
32.3.1 IAC Rampdown	42
32.3.2 IAC Speed	43
32.3.3 IAC Startup	43
32.3.4 Idle Spark	44
APPENDIX 2.0 SENSOR DIAGNOSTICS AND STATUSES	45

1.0 INTRODUCTION & SYSTEM REQUIREMENTS

Holley Performance Products has written this manual for the installation of the **STEALTH TERMINATOR™ EFI** TBI fuel injection system. This manual contains the information necessary for the installation of this kit. It also contains all tuning information. Please read all the **WARNINGS** and **NOTES**, as they contain valuable information that can save you time and money. It is our intent to provide the best possible products for our customer; products that perform properly and satisfy your expectations.

1.1 Engine Requirements

Before moving forward with the installation, please verify your vehicle meets the engine and fuel system requirements below:

- Engine is a naturally aspirated (no supercharger, turbocharger, etc.) V8
- Engine horsepower is between 250 – 600
- Engine has a 4 BBL, 4150 style square flange or universal flanged spread bore intake manifold*
- Unleaded fuel only
- Any RTV silicone sealants used on the engine are sensor safe

* Any square flange Holley type intake manifold will work. A spread bore intake manifold may work with no adapter as long as it is an aftermarket “universal flange” (meaning it has dual bolt patterns), and as long as it has enough material such that no vacuum leaks occur along the perimeter of the throttle body. If there is not enough material, a sealing plate (Weiland® PN 9006) can be used. Factory dual plane intakes will require an adapter (PN 17-6).

NOTE: The **STEALTH TERMINATOR™** system requires the use of the supplied 5/16” thick gasket to provide proper clearance.

1.2 Fuel System Requirements

A complete high pressure EFI fuel system must be installed for the STEALTH TERMINATOR™. The pump should be capable of supplying 255 liters/hour or 400 lb./hr. of fuel at 45 PSI. If using an in-line fuel pump, there should be a coarse pre-filter before the pump. All systems should contain a 10 micron post filter after the fuel pump. An EFI fuel pressure regulator is required. See **Figure 1** below for an example when utilizing a bypass regulator.

Holley offers four fuel system kits. These kits contain all components except the return line. They include detailed instructions (downloadable at www.holley.com). These kits are:

- 526-1 – Perform-O-Flex Stainless Hose, Billet Pump, Regulator, and Filters
- 526-2 – Pro-Lite 350 Hose, Billet Pump, Regulator, and Filters
- 526-3 – Super Stock Hose, Billet Regulator, 12-920 Fuel Pump, and Filters
- 526-4 – Super Stock Hose, Billet Regulator, 12-920 Fuel Pump, and Metal Filters

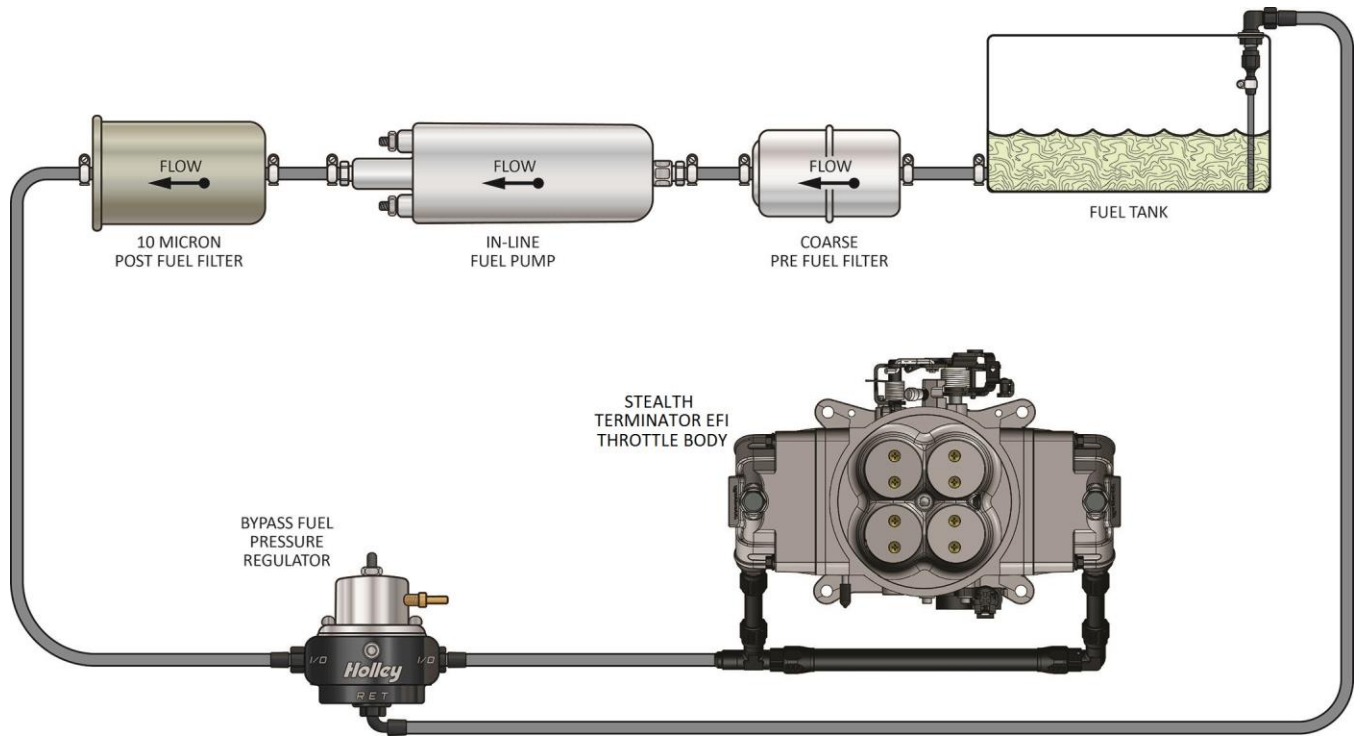

Figure 1

2.0 PARTS IDENTIFICATION

ITEM NUMBER	IMAGE	DESCRIPTION	QTY	SERVICE PART NUMBER	NOTES
1		Bosch Wide Band Oxygen Sensor	1	554-101	<ul style="list-style-type: none"> Use of leaded fuel will degrade sensor. Prolonged use will require periodic replacement. Mounting procedure below is critical for system performance
2a		Clamp-On Oxygen Sensor Bung (Optional)	1	534-58	<ul style="list-style-type: none"> Requires 3/4" hole to be drilled
2b		Oxygen Sensor Weld Ring		534-49	<ul style="list-style-type: none"> Requires 7/8" hole to be drilled Welding should be performed by competent welder or exhaust shop
3		Coolant Temperature Sensor	1	534-10	<ul style="list-style-type: none"> 3/8" NPT Threads – Adapters to 1/2" NPT are available Must be installed in a coolant passage in either the intake manifold or cylinder head. Do not install in thermostat housing.
4		STEALTH TERMINATOR™ EFI Throttle Bodies	1	534-225 (Polished, Without Harness) 534-226 (Hard Core Gray™, Without Harness)	<ul style="list-style-type: none"> 4150 style mounting flange Includes injectors, MAP sensor, TPS, IAT sensor, and IAC
5		Air Cleaner Gasket	1	108-4	<ul style="list-style-type: none"> Hardware and gaskets for mounting throttle body to intake manifold Should be tightened down progressively in a criss-cross pattern to 5-7ft./lbs. Overtightening will damage throttle body!
6		5/16-24 Nuts	4	N/A	
7		Washers	4	N/A	
8		Flange Gasket	1	108-12	
9		Manifold Flange Studs	4	N/A	

10		TERMINATOR™ EFI Electronic Control Unit (ECU)	1	554-114	<ul style="list-style-type: none"> ECU can be mounted inside passenger compartment or in engine compartment if precautions in the installation section are followed Do NOT remove plastic shoulders on mounting ears of ECU
11		3.5" Touch Screen Controller	1	553-108	<ul style="list-style-type: none"> Includes harness to connect directly to CAN connector
12		Main Power Harness	1	558-308	<ul style="list-style-type: none"> Must be connected DIRECTLY to the battery, no exceptions Do not connect to ECU until ALL wiring and installation is performed
13		TERMINATOR™ EFI Main Wiring Harness	1	558-414	<ul style="list-style-type: none"> Connectors are labeled to simplify installation If ECU is mounted in passenger compartment, be sure to use grommet (included) where harness passes through firewall
14		Grommet	1	N/A	<ul style="list-style-type: none"> Used to route Main Harness through firewall Requires 2" hole to be drilled using a hole saw
15		Output Harness	1	558-420	<ul style="list-style-type: none"> Mates to Input/Output connector on Main Wiring Harness and can be used for A/C Shutdown, Electric Fan #1 Output, and/or Electric Fan #2 Output.
16		Ignition Adapter	1	558-302	<ul style="list-style-type: none"> This is only used on applications using a CD box such as an MSD 6AL, when timing control is not desired This plugs in to the connector labeled "IGNITION" and the loose yellow/black wire connects to the "Tach Out" connection on the ignition box Never connect this wire directly to the ignition coil!
17		Throttle Bracket, Throttle and Transmission	1	20-150	<ul style="list-style-type: none"> Used for throttle cable and transmission kickdown for 700/200R
18		Throttle Bracket, Throttle Only	1	20-151	
19		1/4-20 x 5/8 Socket Head Cap Screw	1	N/A	<ul style="list-style-type: none"> Used to secure throttle cable bracket to throttle body with a lock washer (Item 24)
20		Throttle and Cruise Control Stud	1	20-36	<ul style="list-style-type: none"> Used for various throttle and/or transmission combinations
21		Throttle Lever Ball	1	20-2	
22		Throttle Lever Stud	1	20-37	
23		Transmission Kickdown Stud	1	20-40	
24		Lock Washers	3	N/A	
25		1/4-28 Nuts	2	N/A	
26		Stealth Terminator Fuel Line Assembly	1	534-180	
27		Transmission Harness	1	558-405	

Throttle Body Service Parts:

	QTY	P/N
STEALTH TERMINATOR™ Sub-Harness	1	558-441
Intake Air Temperature (IAT) Sensor	1	554-121
Terminator 80PPH Fuel Injector (requires purchase of 4)	1	522-801
Manifold Absolute Pressure (MAP) Sensor	1	554-120
Idle Air Control (IAC) Motor	1	543-105
Throttle Position Sensor (TPS)	1	9920-110
40 AMP Relay	1	534-26
Transmission Harness	1	558-405

Optional Parts:

Small Cap GM HEI Ignition Adapter	1	558-304
Ford TFI Ignition Adapter	1	558-305
Ford Transmission Kickdown Bracket Kit	1	20-152
0-100 PSI Pressure Transducer (1/8" NPT; for monitoring fuel pressure)	1	554-102

3.0 TOOLS REQUIRED FOR INSTALLATION

- | | | |
|---|--|--|
| <ul style="list-style-type: none">• Standard wrench set• Medium blade screwdriver• Drill and assorted bit sizes• Factory Service Manual for your vehicle | <ul style="list-style-type: none">• Small blade screwdriver• #2 Phillips screwdriver• Hole saw (2") (depending on ECU location)• O2 Bung Installation (drilling, welding) | <ul style="list-style-type: none">• Allen Wrench set• Digital Volt meter• Terminal crimping tool |
|---|--|--|

An assistant is necessary for some installation and adjustment procedures and should be present for safety reasons.

WARNING! Disconnect battery before proceeding with any installation.

4.0 OXYGEN SENSOR INSTALLATION

IMPORTANT! Position and support your vehicle on a suitable surface. **USE CAUTION AND WORK ONLY ON A LEVEL SURFACE USING JACKS AND JACK STANDS OF SUFFICIENT CAPACITY TO LIFT AND SUPPORT YOUR VEHICLE. NEVER WORK UNDER A VEHICLE SUPPORTED BY A FLOOR OR BUMPER JACK.** Use of a two-post under arm lift or four-post drive-on lift will considerably reduce the time and effort required to complete the installation. **MAKE SURE LIFT LOCKS ARE ENGAGED BEFORE WORKING UNDER THE VEHICLE.**

OXYGEN SENSOR WELD RING INSTALLATION (Recommended):

WARNING! Failure to disconnect the AIR pump or locating the oxygen sensor downstream from AIR injection will result in an extremely rich mixture, which could cause drivability problems and severe engine damage. If disconnecting AIR pump, check with local ordinances for the legality of this procedure in your area.

1. Locate a position for the oxygen sensor as close to the engine as possible. The oxygen sensor should be mounted at a point where it can read a good average of all the cylinders on one bank. This would be slightly after all the cylinders merge. If you have long tube headers, mount the sensor approximately 1-10" after the collector. You must have at least 18" of exhaust pipe after the sensor. If your vehicle has catalytic converters, the oxygen sensor **MUST** be located between the engine and the catalytic converters.
2. Ensure the location for the sensor is at the angle in **Figure 2**. This will help prevent condensation in the exhaust tubing from entering the sensor. The sensor can be mounted on either side of the tubing.
3. Drill a 7/8" hole in the intended location for the sensor. Weld the **Oxygen Sensor Weld Ring (Item 2b)** into the 7/8" hole. Weld all the way around the boss to insure a leak proof connection. Install the **Oxygen Sensor (Item 1)** into the weld ring and tighten securely. It is a good idea to add anti-seize to the threads to aid in removal. Do not get any anti-seize on the tip of the sensor.

NOTE: Never run the engine with the oxygen sensor installed if it is not plugged in and powered by the ECU, or it will be damaged. If you need to plug the hole temporarily, use an O2 sensor plug or a spark plug with an 18mm thread.

CLAMP-ON OXYGEN SENSOR BUNG INSTALLATION (Optional):

1. Place the vehicle on a flat surface, set the parking brake, and block the front wheels.
2. Lift the vehicle and support with jack stands.
3. Locate a place in the exhaust to drill a 3/4" hole. Make sure to allow enough clearance for an O2 sensor and wiring harness. It is important to keep the O2 bung (**Item 2a**) at least 12 inches from open exhaust. Ensure the location for the sensor is at an angle (**Figure 2**). This will help prevent condensation in the exhaust tubing from entering the sensor. The sensor can be mounted on either side of the tubing.

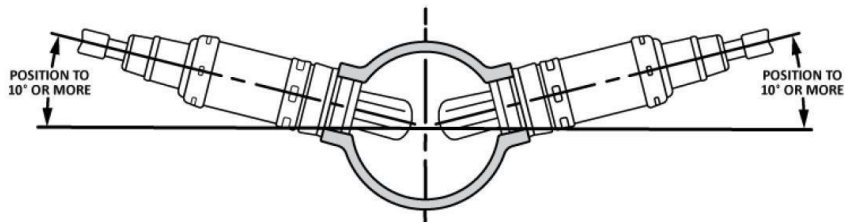

Figure 2

4. Mark the center of the casting on the exhaust tube and drill a 3/4" hole. Deburr the hole after drilling (**Figure 3**).

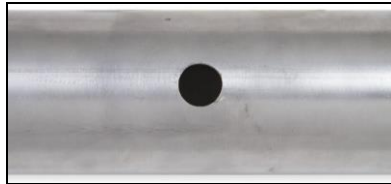

Figure 3



Figure 4

5. Place the gasket on the tube, then the casting on the tube. Slip a clamp on one side and lightly tighten. Slip the second clamp on and lightly tighten.



Figure 5



Figure 6

6. Verify the center of the casting is in the center of the hole and tighten clamps.
7. Install the O2 sensor in the bung. Lightly tighten with a wrench.



Figure 7

5.0 COOLANT TEMPERATURE SENSOR INSTALLATION

1. Install the **Coolant Temperature Sensor (Item 3)** into a 3/8" NPT coolant passage in either the intake manifold or cylinder head. Do not overtighten or damage to the cylinder head or intake may occur. It is best to drain the some of the coolant before the sensor is installed. Use thread sealer or a small amount of thread tape. Do not install the sensor in the thermostat housing, or in an area that will not see a constant flow of coolant.

6.0 THROTTLE BODY & CABLE BRACKET INSTALLATION

1. Disconnect the battery and remove the air cleaner.
2. Before disconnecting any vacuum hoses, it is a good idea to sketch out the vacuum hose routing. Using masking tape and a permanent marker, mark all the vacuum hoses, vacuum sources, and ports before removing the old fuel delivery system.
3. Remove and discard the fuel line that connects to the carburetor from the mechanical fuel pump. This will not be needed in the installation. Remove the throttle return springs and keep for later installation.
4. Remove carburetor (if applicable) and clean mounting flange ensuring no debris falls into intake manifold.
5. Install the four **Manifold Flange Studs (Item 9)** into the intake manifold. Install the **Flange Gasket (Item 8)** between the manifold and the STEALTH TERMINATOR™. Check for sufficient thread engagement of the throttle body hold down studs and nuts.

DANGER! Check for proper clearance between engine components, such as the distributor, coil, etc., and the throttle body. Also check for clearance between the air cleaner and hood. If any interference is found, correct the condition before continuing. Failure to do so can result in damage to the engine components, throttle body, or hood.

6. Position the **STEALTH TERMINATOR™ Throttle Body Assembly (Item 4)** over the manifold flange studs with the throttle lever located on the driver's side.
7. Place the **Throttle Bracket (Item 17 or 18)** for your application over the rear driver's side stud and use **¼-20 x 5/8 SHCS (Item 19)** and a **Lockwasher (Item 24)** to secure.
8. Using the supplied **5/16-24 Nuts and Washers (Items 6 & 7)**, tighten the throttle body down in a criss-cross pattern. Proper torque is 5-7 ft./lbs. **DO NOT OVERTIGHTEN!**

6.1 Throttle Connections

1. The throttle body is designed to provide the proper cable geometry for TH350, TH200R, and TH700R4 transmissions as shown in **Figure 8**. Install the **Throttle and Transmission Studs (Items 20, 21, 22, and/or 23)** for your application in their dedicated holes and secure each with a **Lock Washer (Item 21)** and **1/4-28 Nut (Item 22)**.



Figure 8

2. Once the throttle linkage is attached, have an assistant get in the vehicle and fully actuate the throttle controls. Make the necessary adjustments to the throttle linkage to ensure that the throttle plates are vertical when the throttle control is wide open. Work the throttle linkage back and forth several times to ensure it operates smoothly with no binding or sticking.

DANGER! A sticking throttle may result in uncontrolled engine or vehicle speed. This could cause property damage, personal injury, or death. A sticking throttle may be caused by improperly installed throttle cables, lack of clearance for any of the throttle linkage, or by a binding throttle linkage. Check all throttle cables for proper installation and alignment. Actuate the throttle to check for any potential binding or clearance problems. Repair any problems before continuing.

3. If the vehicle is equipped with an automatic transmission, ensure that the transmission kickdown is properly adjusted. Follow the vehicle manufacturer's procedure for the correct adjustment procedure.

NOTE: On late model GM and Ford overdrive transmissions with a lockup torque converter, make sure the lockup function is properly retained. Failure to do so will result in premature transmission failure.

NOTE: On Chrysler vehicles, a lever extension will be needed, Holley PN 20-7. Van applications may require the use of throttle lever extension Holley PN 20-14.

4. Install external throttle return springs that you previously removed from the carburetor. External springs should be used in addition to the springs on the throttle body itself. Have an assistant get in the vehicle and fully depress the accelerator pedal. Make the necessary adjustments to the throttle linkage to insure that the throttle reaches wide-open position when the accelerator is depressed. Work throttle linkage back and forth several times to ensure that it operates smoothly with no binding or sticking.

DANGER! Failure to attach the throttle return spring or a sticking throttle may result in uncontrolled engine or vehicle speed, which could cause personal property damage, serious injury, or death.

6.2 Vacuum Line Connections

1. Connect the vacuum lines that were previously disconnected. **Figures 9 & 10** show the function of the ports in the STEALTH TERMINATOR™ throttle body.

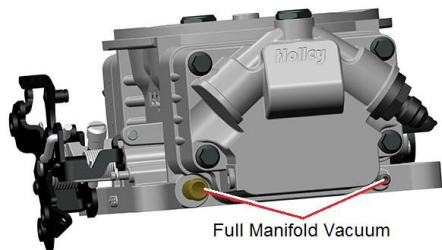

Figure 9

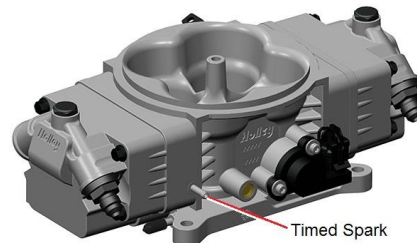

Figure 10

7.0 FUEL SYSTEM

Connect the fuel system per the manufacturer's instructions.

8.0 ECU MOUNTING AND WIRING OVERVIEW

The **Terminator™ EFI ECU (Item 10)** can be mounted inside the passenger compartment (preferable location) or in the engine compartment. If mounted in the engine compartment, follow these guidelines:

- The ECU should be located such that it isn't being directly hit by water or road debris.
- It should also be located such that it isn't extremely close to exhaust manifolds or headers.
- It should be mounted such that it is as far away from spark plug wires, CD ignition boxes, or other "electrically noisy" devices as is reasonable possible.
- Make sure the connector end of the ECU is pointed DOWN such that water can't make its way into the ECU terminals.

The ECU comes with mounting hardware (stainless steel screws and nuts). The ECU has plastic shoulders on the mounting ears. **DO NOT REMOVE THEM.** Do not over-tighten the mounting hardware if the ECU is not mounted on a flat surface.

EFI systems depends heavily on a clean and constant voltage source. ALL grounds of an electrical system are just as important as the power side.

TERMINATOR™ ECU's contain multiple processing devices that require clean power and ground sources. Wiring harnesses must be installed in such a manner that they are separated from "dirty" power and ground sources.

DO'S

- Install the main power and ground directly to the battery. To the POSTS/TERMINALS, not to any other place.
- Keep sensor wiring away from high voltage or "noisy/dirty" components and wiring, especially secondary ignition wiring (plug wires), ignition boxes and associated wiring. It is best that the plug wires not physically contact any EFI wires.
- Properly crimp or crimp and solder any wire connections. Apply quality heat shrink over any of these connections.
- Ensure that the engine is properly grounded to the negative battery post/terminal, as well as chassis.

DON'TS

- NEVER run high voltage or "noisy/dirty" wires in parallel (bundle/loom together) with any EFI sensor wiring. If wires need to cross, try to do so at an angle.
- Don't use the electric fan outputs to directly power a fan. They must only trigger a relay.
- Don't use improper crimping tools.
- Don't use things like "t-taps", etc. Use proper crimpers/solder and heat shrink.
- It is never recommended to splice/share signal wires (such as TPS, etc.) between different electronic control units (i.e. "piggyback").
- Don't connect the red/white switched +12V wire to "dirty" sources, such as the ignition coil, audio systems, or 12V sources connected to HID head lamps.
- NEVER start an engine with a battery charger attached

9.0 WIRING HARNESS INSTALLATION

The STEALTH TERMINATOR™ throttle body comes with sensors pre-wired for easy installation. The illustrated diagram below (**Figure 11**) is intended as an overview of how the system should be wired. Remember, the main ECU power and ground must be connected directly to the battery post/terminal AFTER all other wiring installation has been performed. Do not attach the loose white or yellow wires, or ignition connector until you have referred to section **10.0 (Ignition Wiring)**.

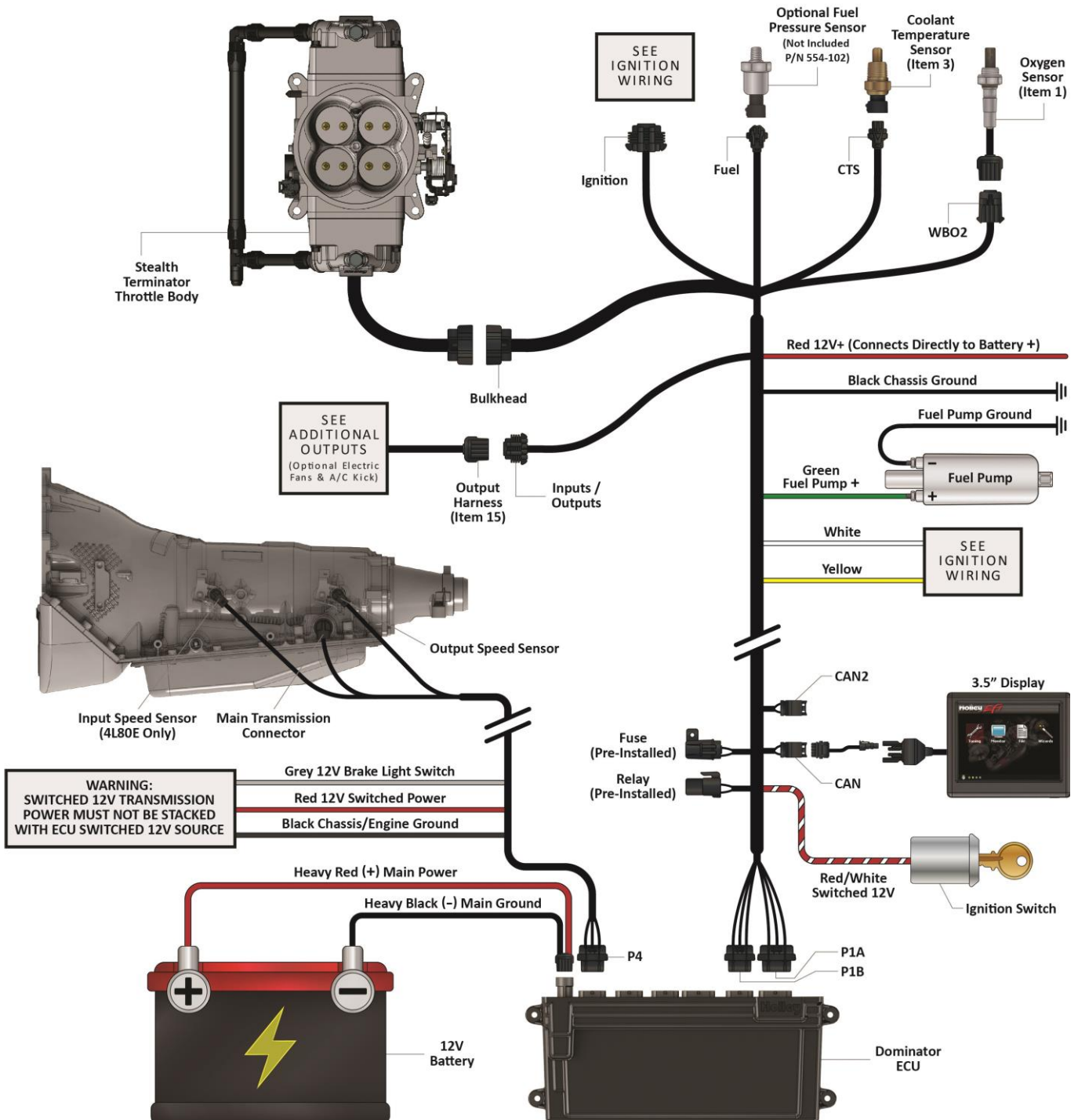

Figure 11

9.1 Harness Routing

If the ECU is mounted in the interior, the harness will have to be routed through the firewall into the engine compartment. Use a 2" hole saw to create a hole in a desired location if no other point of access is available. A **Grommet (Item 14)** is supplied for a 2" hole to seal this area.

If the ECU is mounted in the engine compartment, the hand-held tuning module cable will have to be routed to the "CAN" connector on the main harness (located near the ECU connector main connector). This is assuming you want to access the hand-held module after startup. This will require routing the small CAN connector somewhere through the firewall.

Connect the P1A and P1B connectors of the main harness into the ECU.

About 18" from the ECU main connectors is a 40A Relay. This powers the injectors and fuel pump. There is also a 20 amp fuse for the injectors and fuel pump pre-installed in this location.

9.2 Sensor Connections & Loose Wires

At this time, connect the Bulkhead, CTS, WBO2, CAN, and Fuel (for optional fuel pressure transducer P/N 554-102) connectors to their dedicated sensors/connectors in the diagram on page 8.

The loose wires shown in **Figure 12** should be connected as follows on all systems. These wires come out of the harness about 40" from the ECU connectors except for the "12V Switched" wire (approximately 7").

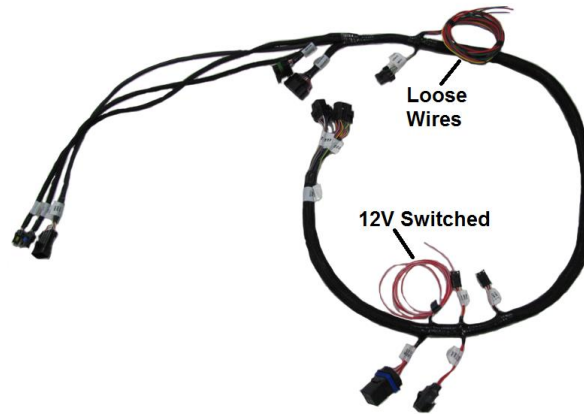

Figure 12

Red/White Wire = 12V Switched

Should be connected to a clean +12 volt switched power source. Switched power source should only be active when the ignition is on. Ensure switched power source has power when engine is cranking as well (check with voltmeter). Not all sources apply power when the ignition switch is in "cranking" position. This wire is located approximately 7" from the ECU connectors. **DO NOT connect to a "DIRTY" source like an ignition coil!**

Red Wire = 12V Battery

Should be connected directly to the battery. This powers the fuel pump and fuel injectors. This wire is protected by a fuse in a sealed fuse holder. The fuse holder is located about 18" from the ECU connector. A fuse is pre-installed (20A).

Green Wire = 12V Fuel Pump

Used to directly power a fuel pump (+12 volt). **Do not use this wire to power fuel pumps that require over 15 Amps.** For high current pumps, use this wire to trigger a separate relay and use larger gauge wire to supply voltage to the pump - 10 gauge is recommended. The pump included with some STEALTH TERMINATOR™ systems draws less than 10 Amps and can be powered directly by this wire. The fuel pump also requires a ground wire. Run a wire from the negative side of the fuel pump. Connect it to a solid chassis/frame ground.

White Wire = Points Output

Used for ignition configurations that must be configured with a laptop computer. See pages 13-21 in the Holley EFI Wiring Manual, located at <http://documents.holley.com/techlibrary199r10555rev17.pdf> or go to www.holley.com, click on SUPPORT, then TECH SERVICE, scroll down and click Resource Documents & Library. Go to the Fuel Injection tab and scroll down to the Holley EFI Wiring Manual.

Black Wire = Chassis Ground

Connect to a chassis ground point that has excellent connectivity with both the engine and battery. This ground should not be connected at the same location as other grounds. It is also important that you have a sufficient ground strap from the engine block to the chassis.

Yellow Wire = "Coil -"

See section 10.0 below. This is an RPM input wire used for *some* applications.

10.0 IGNITION WIRING

The most important signal for the ECU is the Engine Speed input. It is critical that this is configured and wired correctly or poor performance will result. Pay close attention to the options below or ECU damage could result! It is very important that any aftermarket distributors with a rev limiter verification feature

OPTION 1: "Coil -" engine speed input – Use this if:

- You are using a stock type mechanical advance distributor with a stock inductive ignition coil. Examples of this would be any older style points distributor, a 1974-1981 GM large cap HEI.

- Do NOT use this input if you are using an aftermarket Capacitive Discharge (CD) ignition system such as a MSD, Mallory, or others. The ECU will be damaged if you connect to a capacitive discharge type ignition coil.

NOTE: When using this input, the EFI will **NOT** control the ignition timing of the engine. The timing will be based on the distributor initial, mechanical, and vacuum advance, just like it did with a carburetor.

OPTION 1 WIRING:

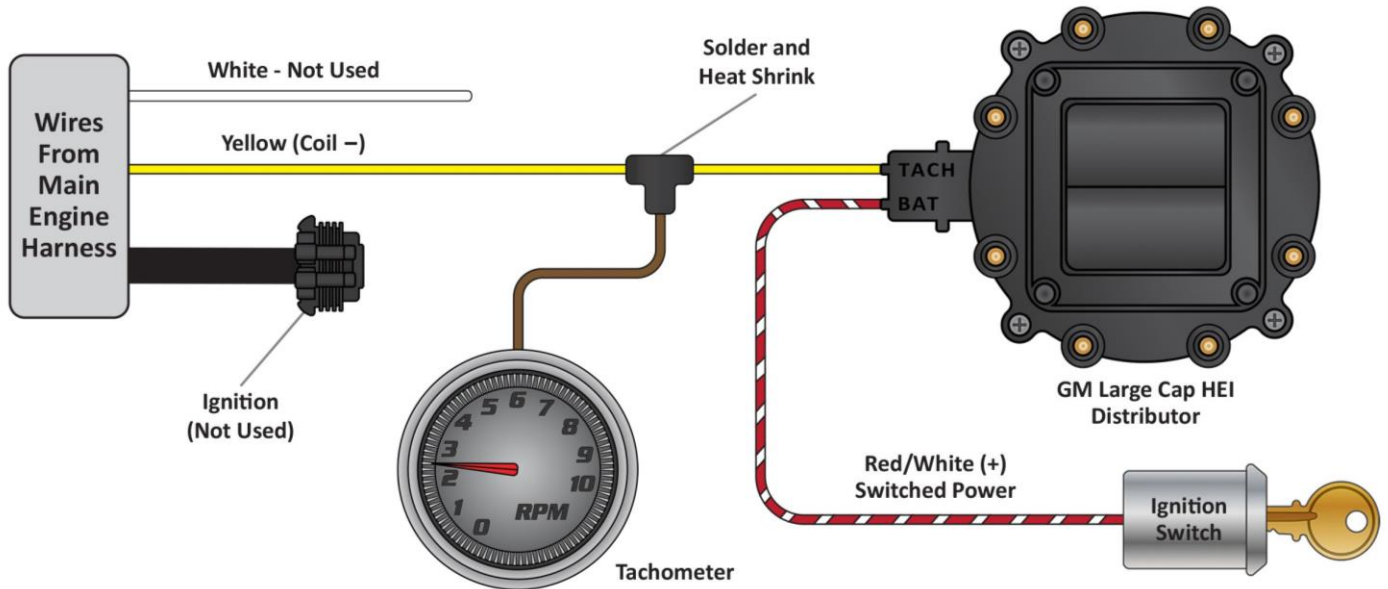

OR

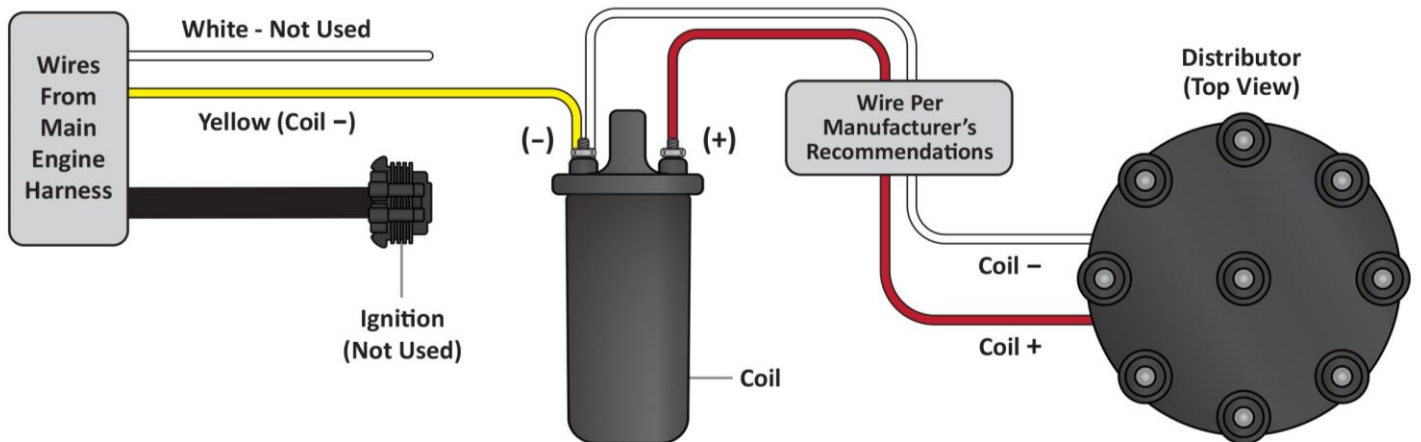

OPTION 2: "Tach Out" engine speed input -

- If you are using an aftermarket Capacitive Discharge (CD) ignition system such as a MSD, Accel, or others, you need to connect to the "Tach Out" connection or wire these systems provide. This is a 12 volt square wave output.

CAUTION! NEVER, NEVER connect any of the EFI wires to the coil on any CD type ignition system. The ECU will be permanently damaged!

NOTE: When using this input, the EFI will **NOT** control the ignition timing of the engine. The timing will be based on the distributor initial, mechanical, and vacuum advance, just like it did with a carburetor.

OPTION 2 WIRING:

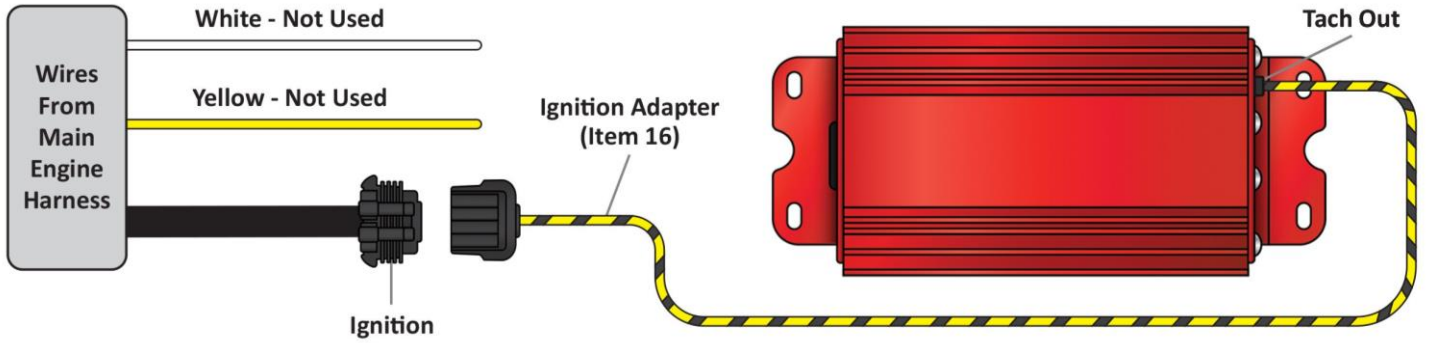

OPTION 3: "GM Small Cap HEI" Computer Controlled Distributor (Requires Holley Ignition Adapter PN 558-304) –

- Small and Big Block Chevy engines can use a small cap GM HEI computer controlled distributor that was available on factory GM vehicles from the 1980's through mid-1990's. This distributor is also available through MSD under part number 8366. The distributor (shown below) provides an engine speed signal to the EFI, as well as allowing the EFI to control the ignition timing.

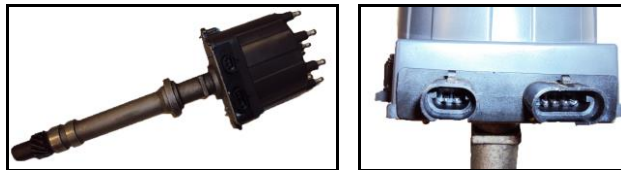

OPTION 3 WIRING:

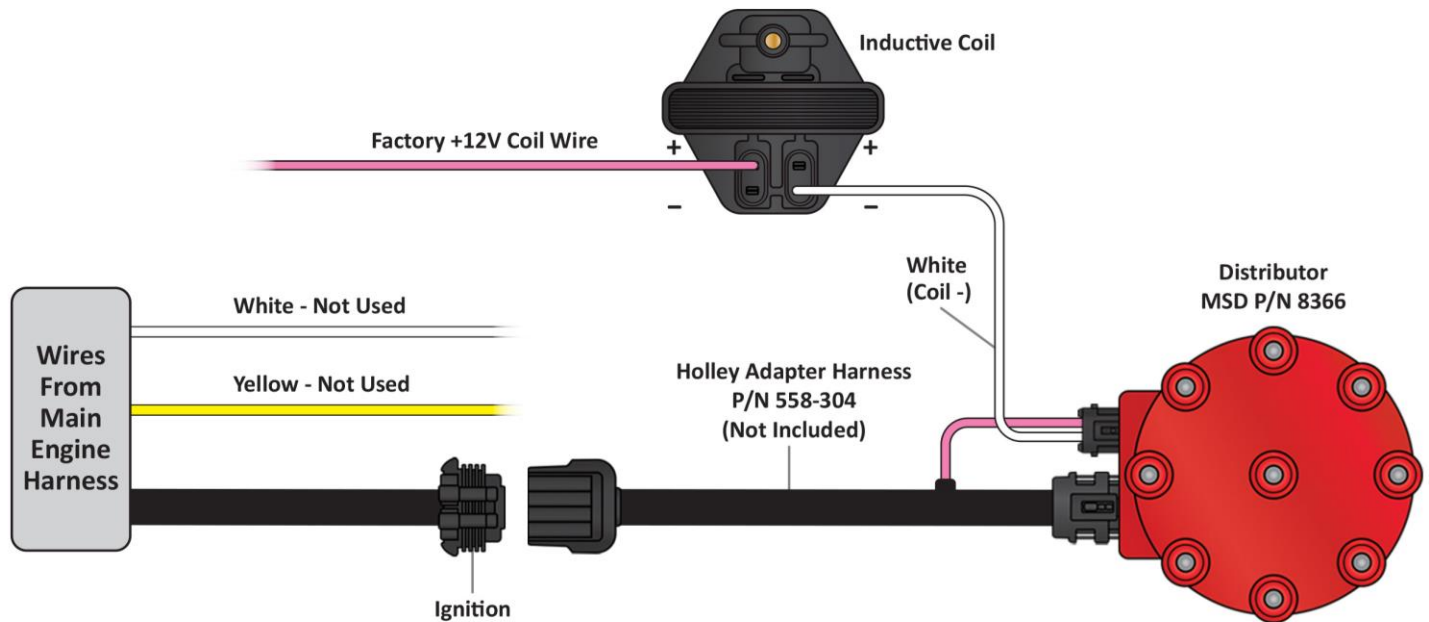

OPTION 3 WIRING W/ CAPACITIVE DISCHARGE BOX (Such as MSD 6AL)

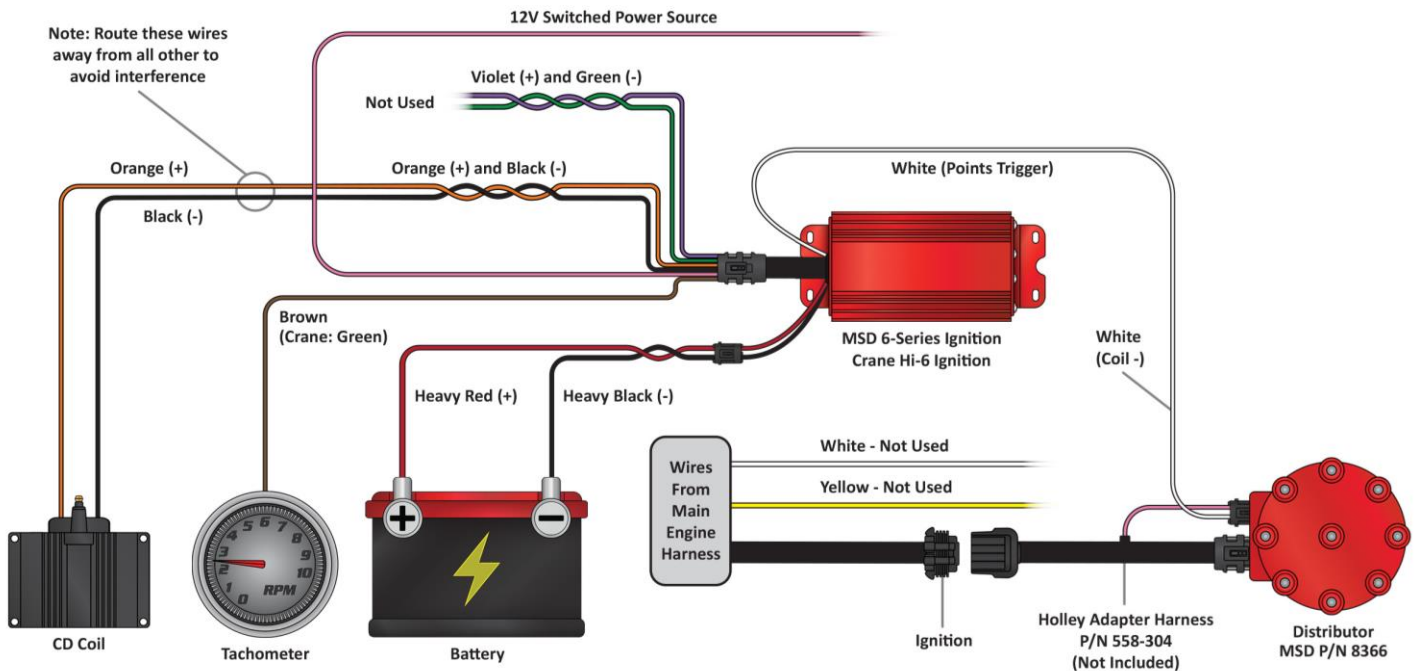

OPTION 4: "Ford TFI" Computer Controlled Distributor (Requires Holley Ignition Adapter PN 558-305) –

- Ford Sequentially Injected 5.0-5.8L engines from 1987-1995 used this distributor. This option will allow the EFI to control the ignition timing.

OPTION 4 WIRING:

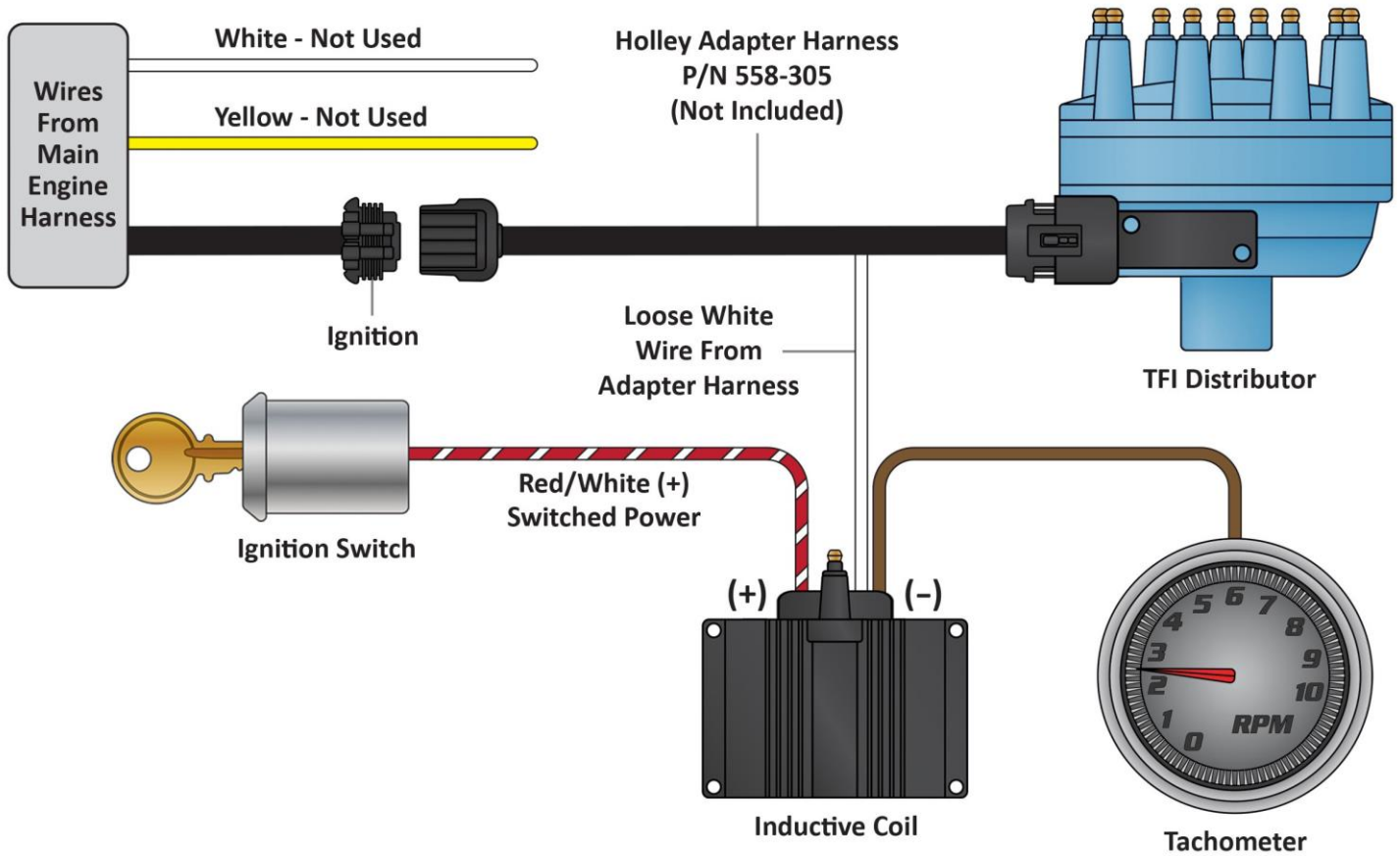

OPTION 4 WIRING W/ CAPACITIVE DISCHARGE BOX (Such as MSD 6AL)

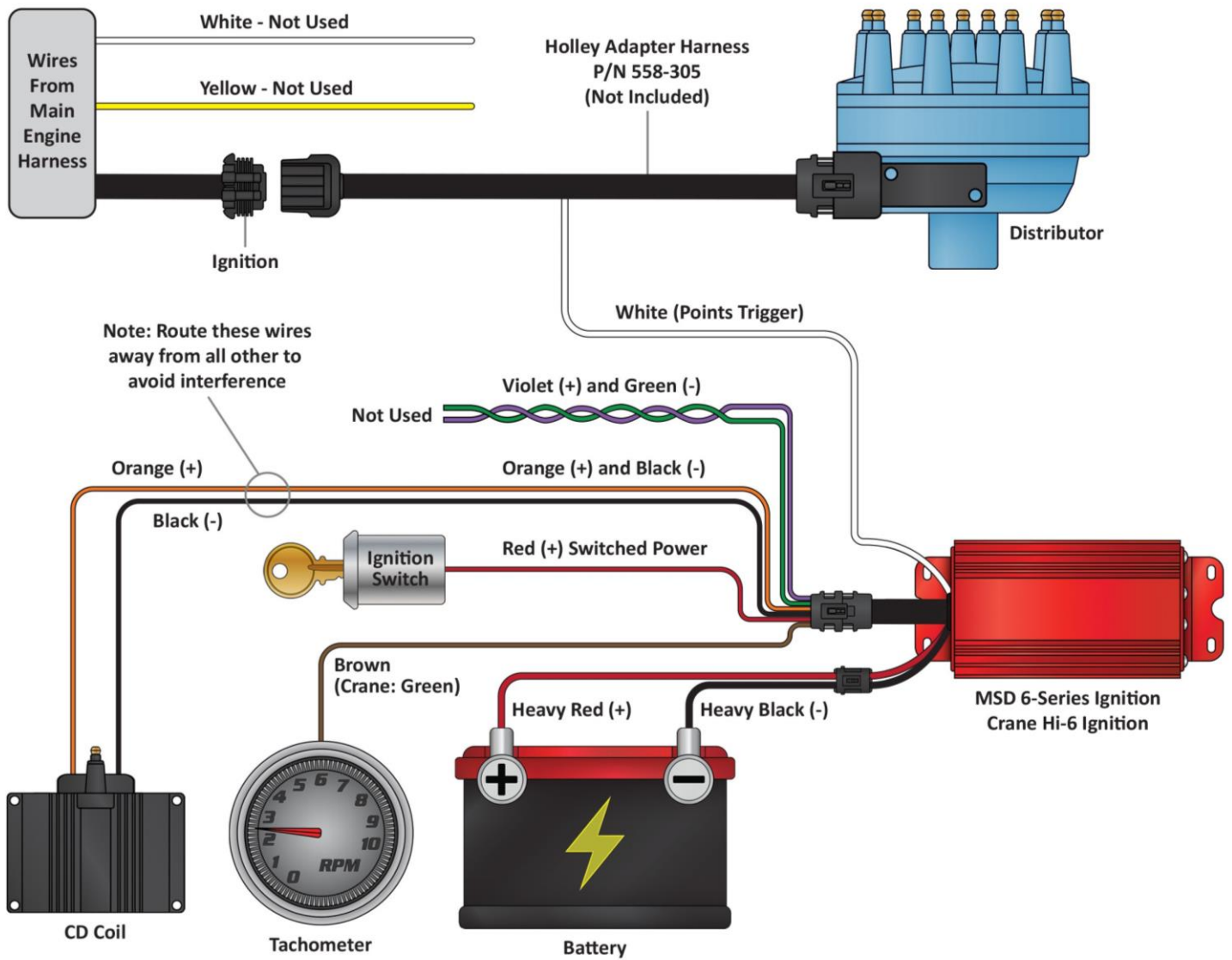

11.0 ADDITIONAL OUTPUTS

There are 3 optional outputs available on the system that can be used for the following features:

- Air Conditioning Shutdown at wide open throttle
- Electric Fan #1 output
- Electric Fan #2 output

Three outputs are located in the "Input/Output" connector. This is a 3 Pin connector is located about 52 inches from the ECU. A mating harness is included with the system.

The following indicates proper wiring for these features.

A/C Shutdown – This output will provide a +12 volt output at a defined throttle position. This output can be used to trigger a relay that deactivates the A/C at higher throttle positions. This may require the installation of a 5 pole relay in the existing A/C wiring. This wire is located in pin A of the 3 pin Input/Output connector and is Gray with a Yellow stripe.

Electric Fan #1 output – This output will provide a ground output to trigger a relay used for a cooling fan. This output should never be directly connected to a fan, but the relay that powers the fan. It should be connected to the ground trigger of the relay. This wire is located in pin B of the 3 pin Input/Output connector and is Gray with a Black stripe.

Electric Fan #2 output – This output will provide a ground output to trigger a relay used for a cooling fan. This output should never be directly connected to a fan, but the relay that powers the fan. It should be connected to the ground trigger of the relay. This wire is located in pin C of the 3 pin Input/Output connector and is Gray with a Green stripe.

12.0 TRANSMISSION WIRING

The transmission harness can be used on 4L60E, 4L65E, 4L70E, 4L80E, and 4L85E transmissions. Each connector should be labeled.

Transmission ECU Connector (P4) – Plugs into the ECU. Plugs into the last connector opposite the main harness.

Main Transmission Connector – Simply plugs into the connector on the transmission. Located on the driver's side of a 4L80E (installed horizontally) and the passenger side on a 4L60E (installed vertically).

Vehicle Speed Sensor (VSS)/Transmission Output Speed Sensor (OSS) – Located on the rear drivers side on a 4L80E and the rear passengers side on a 4L60E

Turbine Speed Sensor – The 4L60E does not have a turbine speed sensor. It is located towards the front driver's side on a 4L80E. Note that a 4L70E has one internally wired, but is not connected to the Holley harness. The turbine speed sensor is not used for any calculations in the ECU, just for monitoring purposes.

Brake Switch (Grey) – Wired to the brake light switch. This must be installed to a +12v source (as most brake light switches are). This input is used to unlock the torque converter when the brakes are applied.

Ground (Black) – Connect to a good chassis/engine ground source

Switched Power (Red w/ White) – This is used to power the relay for the trans solenoids, it should be connected to a +12v power source.

Transmission Power (Solid Red) – Supplies power to the transmission solenoids. This should be connected to a +12v power source capable of supplying 5 amps.

NOTE: The power supplying the Transmission Power (solid red) wire must NOT be tied to the same point that the ECU switched power wire (red/white wire) is connected to. If they are tied together, the transmission power could back-feed power to the ECU and the ECU/engine will not shut off when the key is turned off.

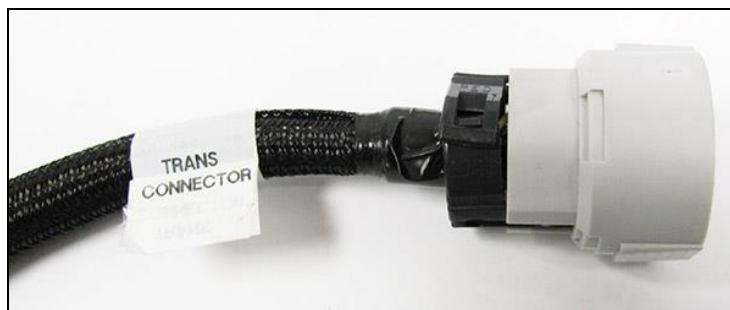

Main Transmission Connector

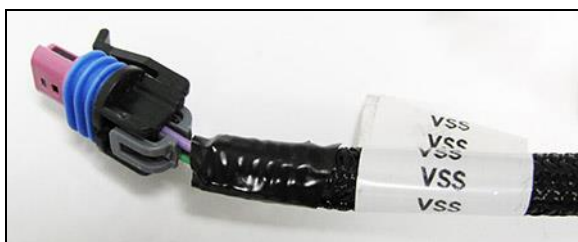

Vehicle Speed Sensor



Turbine Speed Sensor

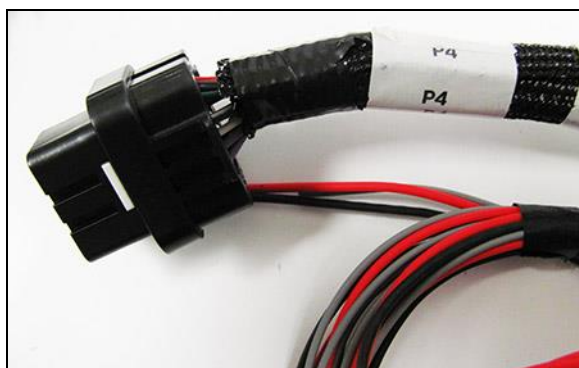

Transmission ECU Connector

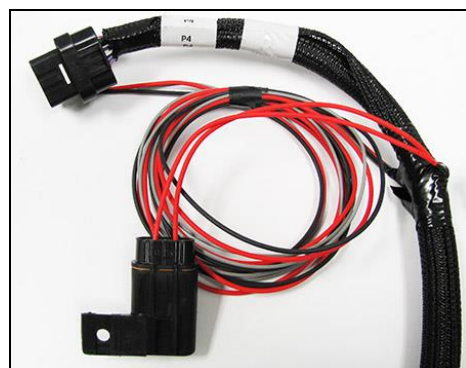

Loose Wire Bundle

13.0 PREVIOUS INSTALLATION REQUIRED

At this point, the installation of your EFI system should be 100 percent complete. The ECU, TERMINATOR™ Handheld controller, throttle body and intake hardware, all sensors, wiring, fuel pump, regulator and return line, and all other hardware should be installed. The vehicle should be ready to start and run. If this is not the case, refer to the hardware installation manual included with your particular system.

14.0 TERMINATOR™ INSTRUCTIONS AND TUNING

The TERMINATOR™ EFI systems are designed to be easy to use for the first time EFI tuner. The instructions are set up in that manner as well. These instructions will not get into detail about EFI theory and operation. They will provide the steps necessary to get you up and running quickly. The TERMINATOR™ system allows for the user to perform some basic changes to the tuning *if they desire to do so*. The instructions are sequenced to get you up and running so you can enjoy your vehicle, then review some of the parameters that can be adjusted to fine tune your vehicle at a later time if desired. **FOR ADVANCED TUNING INFORMATION PLEASE GO TO http://documents.holley.com/techlibrary_199r10751.pdf**

15.0 INITIAL POWER-UP

Turn the ignition key to the “run” position. This should apply power to the ECU as well as the TERMINATOR™ Handheld control module. The handheld should power up and the Home Screen (**Figure 13**) should appear.

The Home screen contains icons which will navigate to different functional features of the 3.5 Touch Screen. These features will be discussed in detail throughout this manual.



Figure 13 – Home Screen

NOTE: DO NOT ATTEMPT TO START THE VEHICLE UNTIL YOU ARE TOLD TO DO SO IN THE INSTRUCTIONS BELOW.

NOTE: The handheld has a SD memory card installed in the side. This card contains specific information that is required for the use of the TERMINATOR™ product. DO NOT replace this card with another. There should be no need to remove this card for normal use.

16.0 HANDHELD NAVIGATION & USE

The 3.5" handheld utilizes a touch screen display. All navigation is done through "touching" an icon or button on the screen. The following is an overview of the different types of adjustment screens that are used in the display, and that may be utilized when tuning or making selections.

16.1 Making Adjustments

Slider Bar: Slide the bar left or right with the stylus, or use the right and left arrow keys for fine adjustment (**Figure 14**).

List: Use the scroll bar on the right hand side of the screen to view all list entries. Touch the desired list item and click 'OK' to make a selection (**Figure 15**).

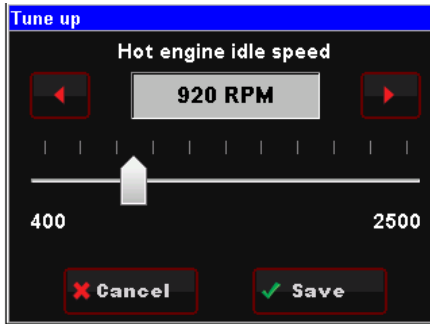

Figure 14 – Slider Bar

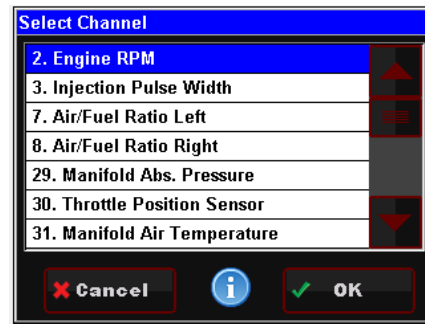

Figure 15 – List

On Screen Prompts: Follow the on screen text and use buttons at the bottom of the screen to continue or confirm.

17.0 HOME SCREEN

The HOME SCREEN has 4 selections (**Figure 16**). They are explained in more detail later in the instructions.

TUNING – Allows for various parameters to be easily adjusted.

MONITOR – A variety of gauge and dash displays.

FILE – Saves and loads files. Also shows information about the ECU and handheld controller.

WIZARDS – Creates a base calibration and performs the "TPS Autose" function.



Figure 16

18.0 CALIBRATION WIZARD

The first step is to create an initial calibration using the WIZARDS located on the HOME SCREEN.

1. Select WIZARDS
2. Select START GCF WIZARD (**Figure 17**)
3. The Wizard process will guide you through each selection step. There will be a question at the top. Select the proper response and select "Next" at the bottom. Selecting "Home" at any time will cancel the process.
4. Next, select "Holley TBI" for the system type (**Figure 18**)
5. Next, select "Terminator" for the TBI System Type
6. Select which type of transmission you are using, 4L60 or 4L80, or "None".



Figure 17

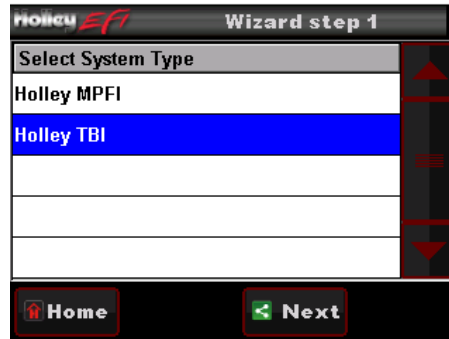

Figure 18



Figure 19



Figure 20

7. If your engine is up to 409 cubic inches, select “Up To 409 CID”. If your engine is larger than 409 cubic inches, select “410 CID and Larger” (Figure 21).
8. The next choice should be dictated by the camshaft size and characteristics (Figure 22). If you have no idea, just simply select “Don’t Know”.

The choices are further defined as:

- “Street Strip” – Camshafts with over 225 degrees duration at .050” valve lift (225°@.050”).
- “Mild Street” – Engines with non-stock camshafts that have between 214-224 degrees duration at .050” valve lift (214°-224°@.050”).
- “Factory Stock” – Engine that have a stock, factory camshaft, or aftermarket camshafts that have a duration BELOW 214 degrees at .050” valve lift (below 214°@.050”).
- “Don’t know” – If you have no idea as to what type of camshaft is in your engine, choose this selection.

NOTE: If you are not sure of the camshaft size, it is best to select “Don’t know”.

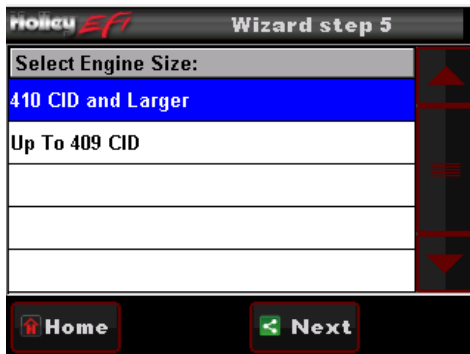

Figure 21



Figure 22

9. Next, you need to select whether the ECU will be controlling the ignition timing (Figure 23). Select “Yes” ONLY if you are using a GM small cap computer controlled HEI distributor or Ford TFI distributor. These are the only ignition distributors that allow the ECU timing control using the TERMINATOR™ system. All other ignition/distributor types must be a standard mechanical advance type used on any carbureted application. If you select “Yes”, proceed to step 10. If you select “No”, proceed to step 11.



Figure 23



Figure 24

10. Select “GM Small HEI” or “Ford TFI” (Figure 24). Proceed to step 12.

11. If you are not controlling timing, you will have the following two choices. It is important the correct item is selected, as well as to double-check that you used the proper input wire when the vehicle was wired.

“Coil – (neg)-” – Select this if you are NOT using an aftermarket Capacitive Discharge (CD) ignition box such as a MSD, Mallory, or others. This is for stock, factory inductive ignition coils. Examples would be a factory GM large cap HEI, or a points style ignition with a canister coil. You should have connected the solid yellow wire in the harness to the negative side of the ignition coil when the wiring was performed.

“CD Box Tach Out” – Select this if you are using an aftermarket Capacitive Discharge (CD) ignition box such as a MSD, Mallory, or others. When you wired the vehicle, you should have used an ignition adapter harness that had a yellow/black wire that you connected to the “tach out” on the ignition box. Nothing should have been wired directly to the ignition coil.

NOTE: If you are unsure of this selection, or wiring, contact Holley tech service. Damage to the ECU will result due to improper wiring.

12. After entering the ignition type, your calibration will be created. Press the “Upload” button to send the calibration to the ECU (Figure 25). You will then see a screen showing “Uploading”. Finally you will see a screen indicating the file is uploaded (Figure 26). Cycle the ignition switch for the calibration to take effect.

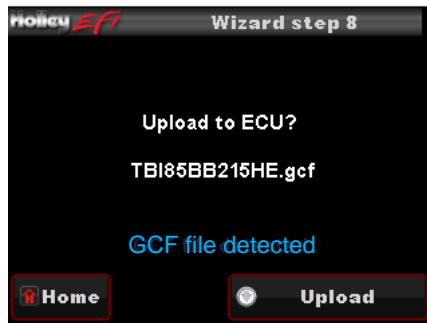

Figure 25



Figure 26

19.0 TPS AUTOSSET

The next step is to perform a “TPS Autoset”. This must be done with the vehicle ignition power on. **This must be done on a brand new system otherwise the injectors and ignition will not be fired by the ECU.** A TPS Autoset programs the ECU with the full travel/voltage range from idle to wide open throttle for the Throttle Position Sensor (TPS). The TPS Autoset function is found under the “WIZARDS” choice under the HOME SCREEN. Select “START TPS AUTOSSET”. Follow the prompts. You can select “Home” at any point to stop the process. If everything is successful, you will see a TPS Autoset Successful message.



Step 1: Select TPS Autoset



Step 2



Step 3



Step 4: Select 'Done'

20.0 TRANSMISSION SETUP

At this time, if an electronic transmission is being used, basis drivetrain parameters need to be set up.

20.1 Transmission

Selecting TRANSMISSION brings up the following menu. There are two areas you can modify; TRANS SETUP and SPEED CALC. These are reviewed below.



Figure 27

20.1.1 Trans Setup

Transmission RPM: If this RPM is exceeded when in manual shift mode, the transmission will upshift automatically. If a manual downshift is performed, and this RPM will be exceeded, the downshift will not be allowed. This value should be slightly higher than the WOT shift points.



Figure 28

20.1.2 Speed Calc

Four pieces of information will need to be entered via the 3.5 handheld to attain proper speedometer calibration when using Holley transmission control

- **Tire Diameter** – From 10.0 to 70.0 inches (Example 26.4)
- **Rear Gear Ratio** – From 0.50 to 9.99 (Example 3.73)
- **Speedometer Output** – Enabled or Disabled
- **Pulses Per Mile (PPM)** – The pulses produced per mile

NOTE: The terminator harness does not have a Speedometer output wire, nor is the calibration programmed for it.

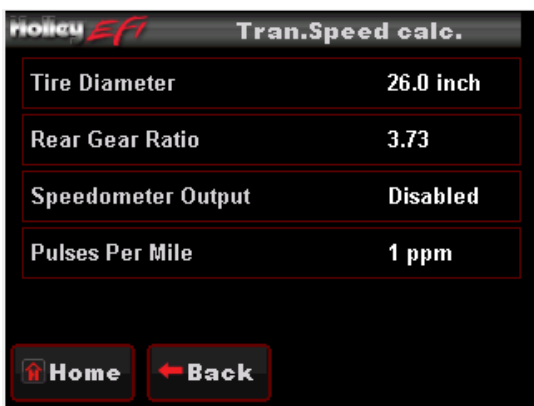

Figure 29

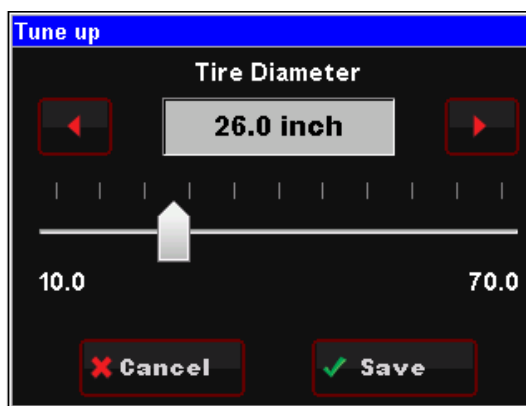

Figure 30

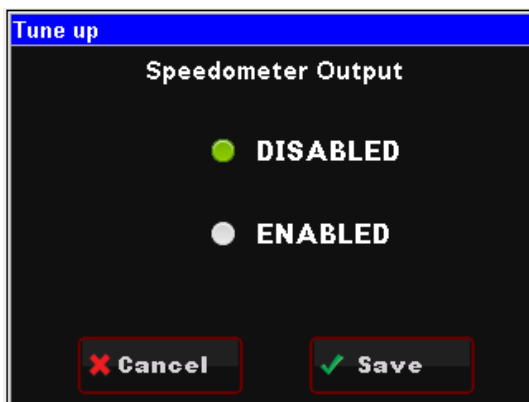

Figure 31

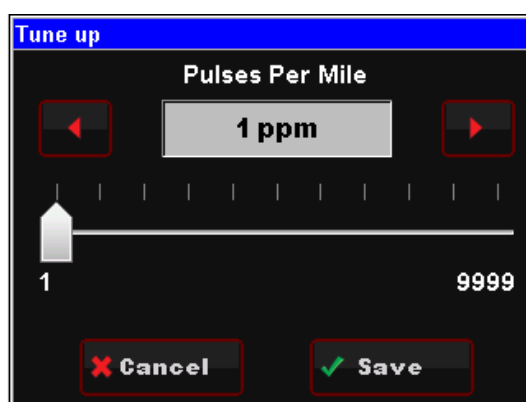

Figure 32

21.0 SENSOR VERIFICATION

Before starting the vehicle, verify that all of the sensors are reading properly. At this time, turn the key off, and cycle it back on. At this time you should hear the fuel pump come on and run for 5 seconds. Check for fuel leaks at this time as well.

On the HOME SCREEN, select the MONITOR tab. This will bring up various options. Select the "Monitors" screen. You will see a screen called "Sensors". Select this. With the key on and the engine off, these sensors should read as follows:

- **MAP** (Manifold Air Pressure Sensor) – Should read from 95-102. At high elevations it could read as low as 75.
- **TPS** (Throttle Position Sensor) – Should read 0. Slowly depress the throttle to wide open. It should read 100 at wide open throttle. If it reads 1-2, you may want to lower the idle screw on the throttle body.
- **MAT** (Manifold Air Temperature Sensor) – reads current air temperature
- **CTS** (Coolant Temperature Sensor) – reads engine temperature. If the engine is "cold", it should read almost the same as the MAT sensor.
- **Battery** – Will read battery voltage. Should be 12.0 volts minimum.

If ANY of these sensors are not reading properly, this must be resolved before the engine is started.

22.0 STARTUP

The vehicle should be ready to be started. Open the sensors screen. Make sure the TPS is reading 0. If it does not, do a TPS AUTOSET, or if it is reading 1-2%, close the idle screw on the throttle body slightly.

Crank the engine and look at the RPM parameter. It should change to "Syncng", indicating the ECU is syncing with the RPM signal for an instant, then show an RPM signal. The engine should fire and run and come to an idle.

If you do not get an RPM signal, there is an error in the wiring or system setup. Call Holley Tech service for advice.

If the engine starts but is idling too low and appears to be struggling for air, you may have to open the throttle body idle speed screw at this time. If you move the screw, you will need to perform a TPS Autaset.

23.0 SETTING IGNITION TIMING

If you are using a computer controlled GM HEI or Ford TFI distributor, you must sync up the ignition timing with the ECU. You must have a timing light to perform this. You will possibly need a dial-back timing light or a harmonic balancer that is degreed up to 40 degrees. Again, open the Sensors monitor screen. You will see the "Ign Timing" parameter which will display what the commanded ignition timing is. Rev the engine up (CAREFULLY) to approximately 2000 RPM. Note the timing value on the handheld. Using the timing light, turn the distributor until the timing you see with the timing light matches what is on the handheld. Once synced, tighten down the distributor. From this point on, do not turn the distributor. The timing on the handheld should always match the timing on the distributor.

IMPORTANT NOTE: The timing at idle (TPS = 0) might be seen to be rapidly fluctuating. This is due to the ECU using the ignition timing to stabilize the idle. This is normal. This is why you need to check and sync the timing around 2000 RPM.

24.0 AFTER-STARTUP

Once the vehicle has started, look for any fuel or coolant leaks. Let the vehicle warm up and look at some other parameters to make everything is operating properly. Go into the MONITOR, MONITORS, and select the "Closed Loop" Icon.

- **Closed Loop Status** – Indicates whether the engine is "Closed Loop" or "Open Loop". Closed Loop indicates that the ECU is adding or subtracting fuel to maintain the target air/fuel ratio. The TERMINATOR™ calibrations are such that the system should be operating closed loop almost all of the time.
- **Closed Loop Compensation** – This is the percentage of fuel that the ECU is adding or subtracting to maintain the target air/fuel ratio at any specific moment. A value with a minus (-) sign in front indicates the ECU is removing fuel. A value with no minus sign indicates the ECU is adding fuel. When in open loop operation, this will always stay at 0%.
- **Target Air/Fuel Ratio** – This is the target AFR (air/fuel ratio) the ECU is trying to maintain. This will vary depending on the engine speed and load.
- **Air/Fuel Ratio Left** – This will show the air/fuel ratio the wideband oxygen sensor is reading. The Closed Loop Compensation should be adding or subtracting fuel all the time such that the AFR Left should always be close to the Target AFR value. (Note ARF Right will only be active if a second sensor is being used which is not included).
- **Fuel Learn Status** – This indicates the status of the TERMINATOR™ "Self Tuning" operation (Learn Status). The system will automatically tune itself as you drive around. There are several conditions that must occur in order for the Self Tuning to occur. The engine temperature must exceed 160° F. The system must be operating in a closed loop mode, and the Self Tuning must be enabled. The base TERMINATOR™ setups have the Self Tuning enabled. Once the engine reaches 160° F, the Self Tuning should be active. The Learn Stat will show "NoLearn" when Self Tuning is not active and "Learn" if Self-tuning is active.

If any of these parameters are not showing a proper value, find out why before further driving the vehicle.

25.0 IDLE SETTING/THROTTLE PLATE SETTING

Once the engine is up to operating temperature, the idle speed can be set to what is desired.

From the HOME SCREEN, select the TUNING tab. Then select the BASIC and then BASIC IDLE. You can see what the target hot idle speed is set to. If you are happy with the current value, use the BACK or HOME button to exit. If you would like to change it, click on the IDLE SPEED. This brings up a screen to adjust the idle speed. Move the button left and right to adjust it. Click the button to save the new value or select CANCEL at the bottom to move out of this screen.

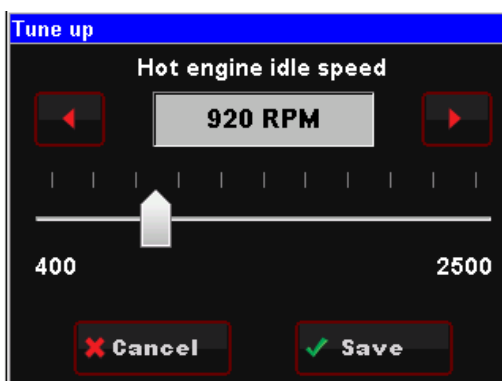

Figure 33

Whether you change the target idle or not, you need to set the throttle plates on the throttle body to an optimal position. To do so, with the engine running select the MONITOR tab. You will see the IDLE screen. Look at the "IAC Position" value. This value should be set

between 2 and 10 with the engine in neutral and up to operating temperature. Also make sure the “TPS” value is showing a value of 0. If it is not, you need to perform a TPS AUTOSET.

If the “IAC Position” value is showing zero, you must close the throttle plates until it reads a value of 2-10. Slowly turn the throttle shaft adjustment screw on the throttle body out (counter-clockwise). If the IAC position is “stuck” at 0, it is likely that the engine is idling at a higher speed than you have set the target idle speed for. You need to adjust the throttle plates to resolve this issue.

If the “IAC Position” value is greater than 10, it is a good idea to open (turn the throttle shaft adjustment screw in, clockwise) the throttle plates until the “IAC Position” value is between 2 and 10. Note that if you open the throttle plates such that the “TPS” position goes above a value of 0, you will need to shut the vehicle off and perform a TPS AUTOSET. Then restart the vehicle and continue adjusting the throttle plates. Once the TPS goes above a value of 0, the ECU goes out of its “idle” mode and will lock the IAC Position to a fixed value.

When the adjustments are completed, make sure the TPS reads a value of 0 with the engine idling.

26.0 SELF-TUNING

At this point, it is time to just drive the vehicle and let the system perform its self-tuning process. The best way for this is to drive the vehicle under as many different operating conditions as possible. Different engine speeds and loads. Start by slowly revving the engine up in neutral and holding it at different speeds up to 2500 RPM. This will help the system learn these points. Then drive the vehicle, possibly using different transmission gears to learn in different areas. If you have an automatic transmission you may want to put it in gear, and with your foot on the brake pedal, apply a SMALL amount of throttle so that the system learns in this area as well.

NOTE: There are several conditions where Learning will NOT occur. They are the following:

- If the engine is below 160° F
- When the engine sees quick accelerator pedal movement
- Certain times when the accelerator pedal is lifted and the vehicle is coasting
- If the learn is disabled by the user

If you are interested in seeing if Self Tuning is completed in a certain area, you can look at the following:

- Select MONITORS from the HOME SCREEN
- Select the LEARN icon
- The FUEL LEARN STATUS indicates if the learn feature is active. The FUEL LEARN PERCENT indicates what the learn value is.
- Look at the CLOSED LOOP COMPENSATION value. Once this value is close to zero, learning is complete in an area.

At this point you can drive and enjoy your TERMINATOR™ EFI as it is. Sections 28.0 – 32.0 describe how you can adjust various parameters to further optimize fuel economy and overall performance, if desired.

27.0 GAUGE SCREENS

The display has a nice variety of pre-configured gauge screens and also allows the customization of them as well. There are also user-programmable caution and warning limits. The following reviews these areas.

27.1 Monitor

Choose MONITOR from the HOME screen to access live telemetry and customizable gauge screen options.



Figure 34

27.1.1 Multi-Gauge

- **Sensors:** Manifold Absolute Pressure (MAP), Coolant Temperature (CTS), Throttle Position (TPS), AFR Left, Engine RPM (analog), Battery Voltage, Ignition Timing, Manifold Air Temperature (MAT), Fuel Pressure, Engine RPM (digital), and Fuel Injector Duty Cycle.
- **Air/Fuel Ratio:** AFR Left, Target AFR, AFR Right, Closed Loop Compensation, Fuel Learn, Closed Loop Status, Engine RPM (analog), Learn Status, Fuel Injector Pulse Width, Engine RPM (digital), and Oil Pressure.
- **Outputs:** Fan #1, Fan#2, AC Shutdown, CTS, Engine RPM (analog), IAC Position, AFR Left, Battery Voltage, Fuel Pressure, Engine RPM (digital), Oil Pressure.
- **Drive by Wire:** TPS, Pedal Position, TB Position, TB TPS #1, Engine RPM (analog), Pedal TPS1, TB TPS #2, Pedal TPS2, Brake Pedal, Engine RPM (digital), MAP.
- **Transmission:** Gear, Engine RPM (digital), Line Pressure, TCC Duty, Engine RPM (analog), TCC Lockup, Line Temp, Input Shaft Speed, TPS, Speed, Fuel Economy.
- **Dash 1, 2, & 3:** See the 'Dash Setup' section

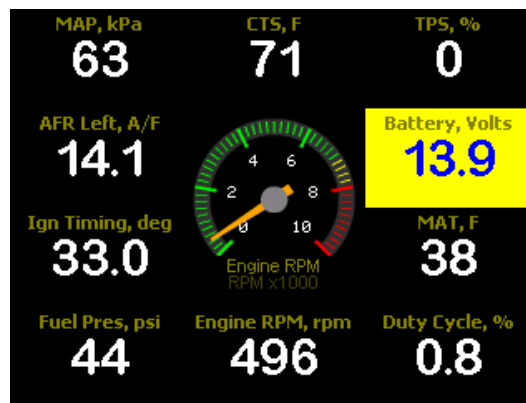

Figure 35 – Sample of Multi-Gauge Screen

27.1.2 Monitors

- **Idle:** Engine RPM, TPS, IAC Position, AFR Left, Ignition Timing
- **Learn:** Fuel Learn Status, Fuel Learn Percent, Closed Loop Compensation, Target AFR, AFR Left
- **Closed Loop:** Closed Loop Status, Closed Loop Compensation, Target AFR, AFR Left, Fuel Learn Status
- **Sensors:** MAP, TPS, MAT, CTS, Battery Voltage
- **Fuel:** Engine RPM, AFR Left, Injector Pulse Width, CL Comp, Injector Duty Cycle
- **Misc:** Oil Pressure, Fuel Pressure, Fan #1 Status, Fan #2 Status, AC Shutdown Status
- **Drive by Wire:** Gas Pedal Position, TB TPS #1, TB TPS #2, Pedal TPS #1, Pedal TPS #2, TB Position, Brake Pedal Position
- **Transmission:** Gear, Speed, Line Pressure, Line Temperature, TCC Duty Cycle, TCC Lockup Status, Input Shaft Speed

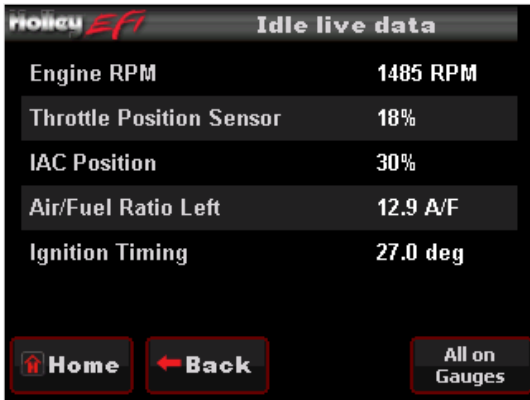

Figure 36

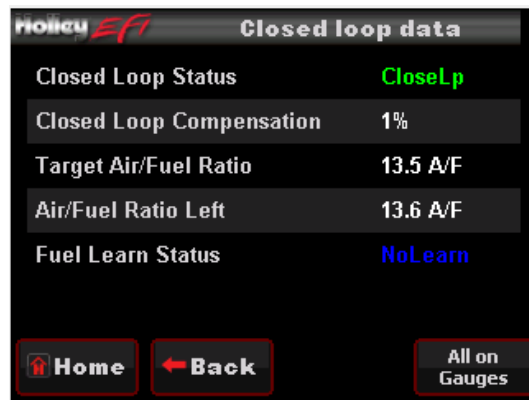

Figure 37

Samples of Monitor Screens

27.1.3 Diagnostics

Channels displayed are: AFR Left, AFR Right, MAP, TPS, MAT, CTS

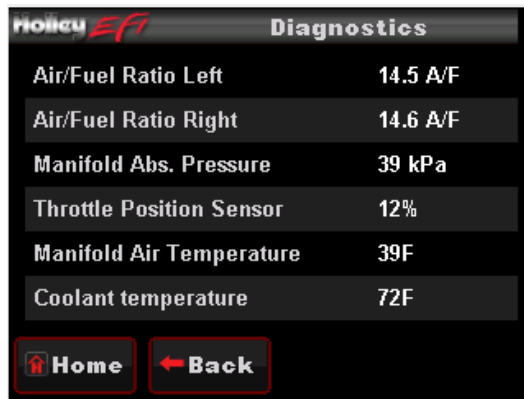

Figure 38 – Sample Diagnostics Screen

28.0 Custom Setups

28.1 Dash Setup

Up to three (3) Custom gauge layouts can be created on the 3.5 Touch Screen. Follow these steps to configure:

Step 1: Choose 'Dash Setup' from the Multi-Gauge screen (Figure 39).

Step 2: Choose the Dash number to be configured (Figure 40).



Figure 39



Figure 40

28.2 Channels Scaling

Each HEFI channel displayed by the 3.5 Touch Screen can be configured to have caution and warning indicators. To do this, choose 'Channel Scaling' from the MONITOR menu. Cautions will display as Yellow and Warnings will display as RED when using the Multi-Gauge screens.

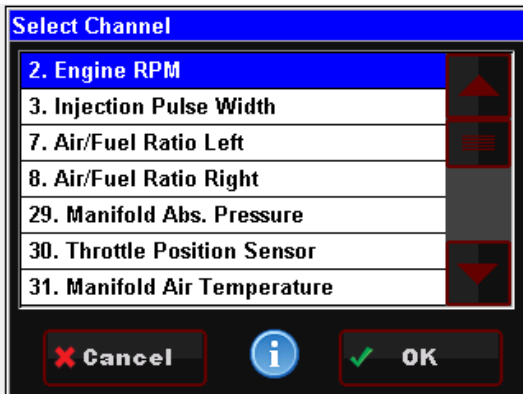

Figure 41

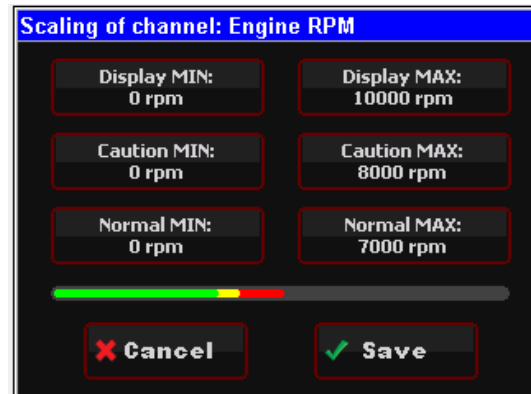

Figure 42

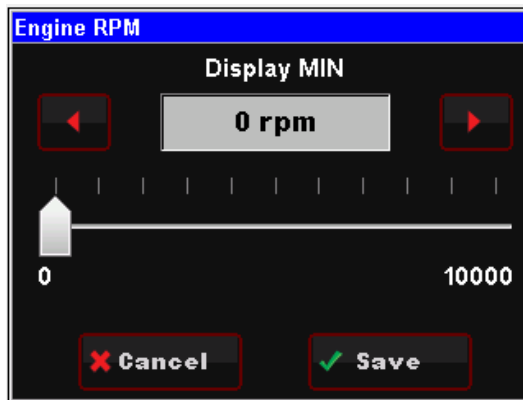

Figure 43

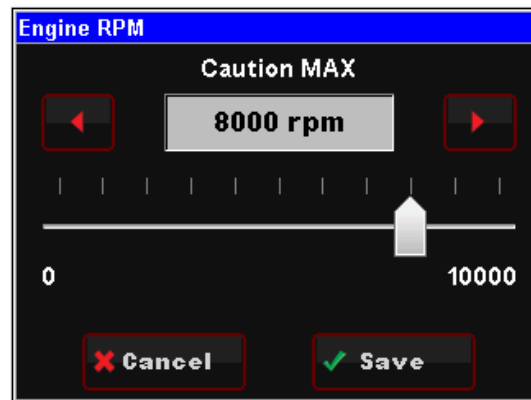

Figure 44

29.0 FILE SAVING/LOADING

The following areas review the options located under the FILE selection. Access to any of these areas should not be necessary for normal use of your Terminator system.

29.1 File

Choose FILE from the HOME screen to access ECU and 3.5 touch screen information. This is also where ECU logging and Global Folder (calibration file) transfer menus are located.

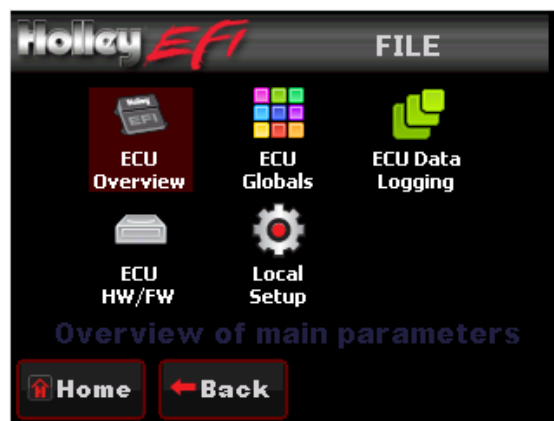

Figure 45

29.1.1 ECU Overview

Information specific to the engine and ECU configuration is shown here, these include the name of the current global folder, transmission type, ignition input type, WBO2 type, throttle body type, fuel system type, and ECU firmware version. Note that this menu is view only – no information can be changed. Any changes to engine or transmission setup must be done through the TUNING or WIZARDS menu.

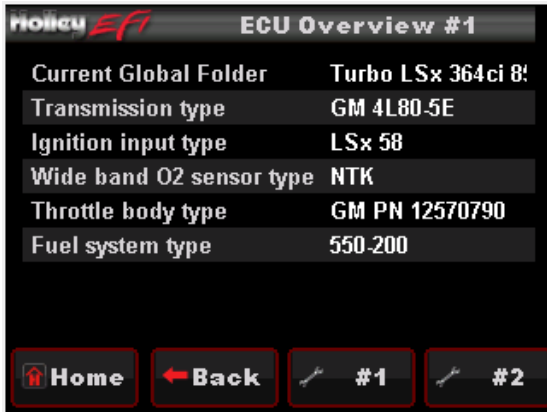

Figure 46



Figure 47

29.1.2 ECU Globals

This menu will list any global folders that have been saved to the SD card. It will also allow you to download a global folder from the ECU to the SD card so that it may be opened on any Windows based PC with free Holley EFI software installed. Software may be downloaded at <http://www.holley.com/data/TechService/Technical/Holley%20EFI%202.2.0.3%20Setup.zip>



Figure 48 - Global Folders List

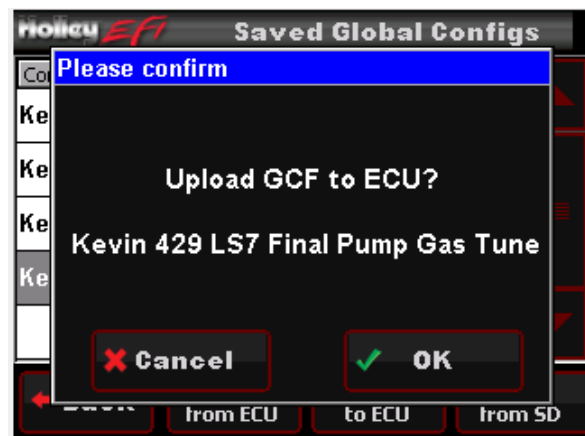

Figure 49 - Global Folder Upload to ECU from SD Card

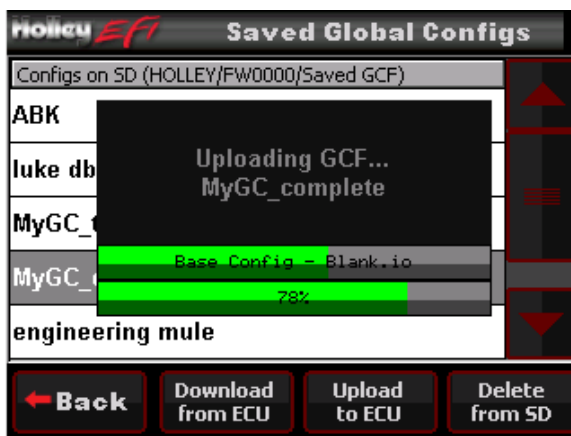

Figure 50 - Upload Status Screen

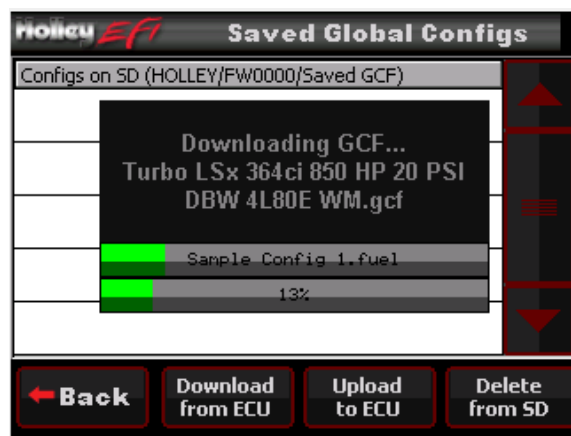

Figure 51 - Global Folder Download to SD Card Status Screen

29.1.3 ECU Data Logging

Holley HP and Dominator systems come standard with powerful data logging capabilities. Logging can be stopped and started via the 3.5 Handheld. The sampling rate is adjustable from 1 to 100 samples per second and can be changed by selecting 'Setup'. Typically a high sampling rate is used for drag racing and a lower rate may be used for something such as road racing. Choosing 'Files' in the DATA LOGGING menu will display all logs contained within the ECU's memory, from here any file may be saved to the SD card and viewed through the Holley EFI PC software.

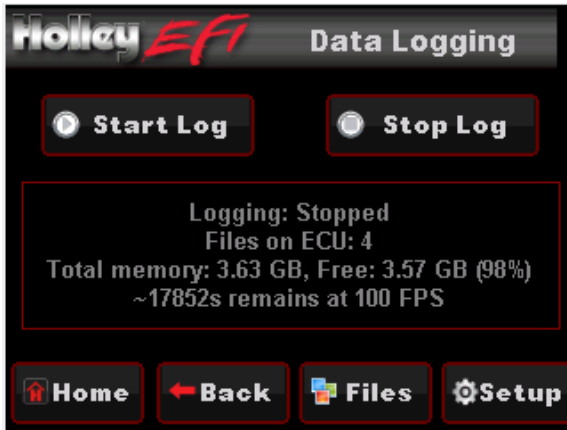

Figure 52

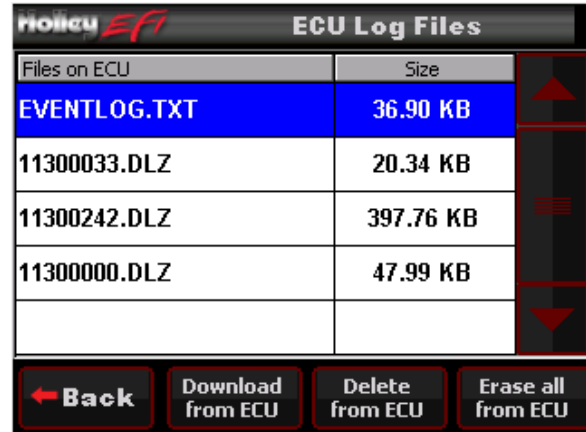

Figure 53

29.1.4 ECU Hardware/Firmware (HW/FW)

Use this menu to update ECU Firmware. Also includes ECU data including serial number, date code, firmware version, and profile number.



Figure 54

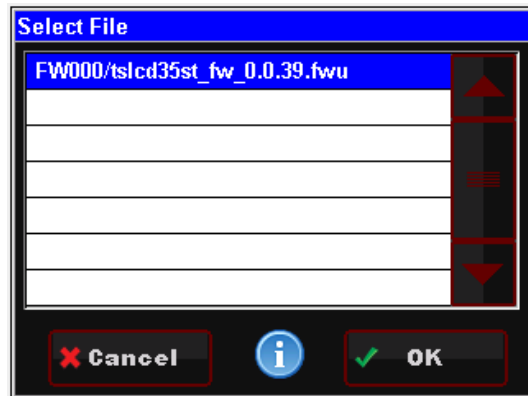

Figure 55

29.1.5 Local Setup

Contains calibration options for the 3.5 Handheld: Touch Calibrate, Local Info, & Local Options.

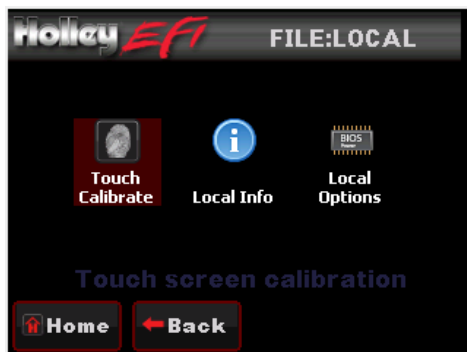

Figure 56

29.1.5A Touch Calibrate

The touch screen may be recalibrated by following the on screen prompts.

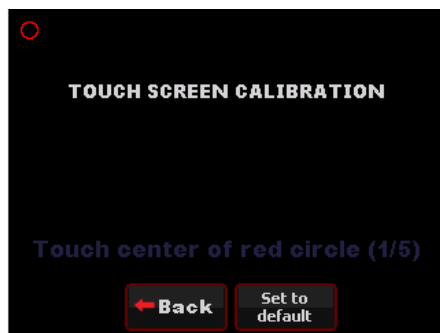

Figure 57

29.1.5B Local Info

Displays device and firmware information for the 3.5 Handheld.



Figure 58

29.1.5C Local Options

By selecting 'Restore screens on startup' the 3.5 Handheld will revert to the last screen used prior to powering off.

30.0 BASIC TUNING

The TERMINATOR™ systems allow the user to perform some basic tuning changes to help optimize mileage, drivability, and performance. The tuning is split up into "Basic Tuning" and "Advanced Tuning". The Basic Tuning allows changes to the Air/Fuel Ratio's the engine runs at and changes to Ignition Timing if a GM HEI or Ford TFI is used. The Advanced Tuning is typically not needed, but allows changes to some items that are less commonly used, or require some careful understanding before changing.

From the HOME SCREEN, select TUNING, and BASIC. There are six areas you can modify, BASIC FUEL, FUEL LEARN, BASIC IDLE, SPARK, DRIVE BY WIRE, and TRANSMISSION (with Drive by Wire and Transmission applying if applicable). These are reviewed below.

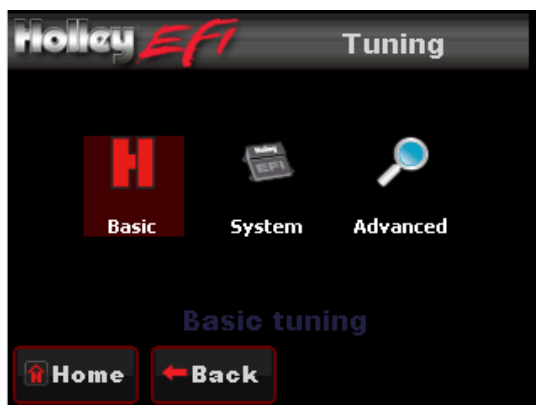

Figure 59

30.1 Basic Fuel

Selecting BASIC FUEL brings up the following menu:



Figure 60

30.1.1 Target AFR

Allows changes to the Target Air/Fuel ratio at idle, cruise, and wide open throttle. The following are typical values and some tuning notes.



Figure 61

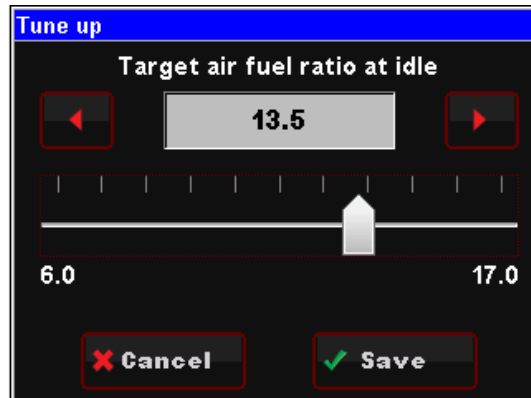

Figure 62

- **Idle Air/Fuel Ratio** – Typically between 13.5 and 15.0. Engines with larger cams may need a richer setting for smoothest idle.
- **Cruise Air/Fuel Ratio** – Typically between 13.5 and 15.5. Engines with larger cams may need a richer setting for smoothest operation.
- **Wide Open Throttle Air/Fuel Ratio (WOT)** – Typically between 12.0 and 13.0. Running richer may reduce power. Running leaner may reduce power or cause potential engine damage.

NOTE: The Target Air/Fuel setting between IDLE, CRUISE, and WOT is blended together automatically. Consequently, the air/fuel you see on the MONITOR screen, may not be exactly what you set for the settings. Changing these settings raises or lowers the “curve” of that specific area.

30.1.2 Acceleration Enrichment

Changes the “accelerator pump” function of the fuel injection. Raising the number increases the amount of fuel added when the pedal is pushed. Lowering the number decreases the amount of fuel added when the pedal is pushed. It is highly recommended NOT to change this until the ECU is allowed to perform self-tuning.



Figure 63

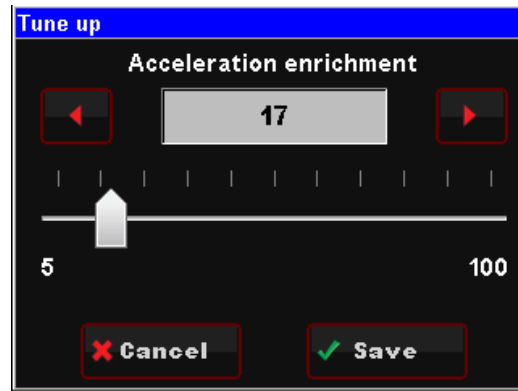

Figure 64

30.1.3 Fuel Prime

Fuel prime is an option that is enabled by default in all of the base calibrations. The fuel prime function injects a small shot of fuel into the intake manifold when the ignition is turned on, wetting the intake and allowing the engine to start much quicker. The amount of fuel is based on the engine temperature and how long it was since the engine previously ran. This amount of fuel can be increased or decreased by changing the “Percent” value. If the engine seems flooded reduce this value, if the engine seems to want more fuel, increase it. Experiment for best results. Typically this value will range from 75-150% with a maximum of 200% typically used.

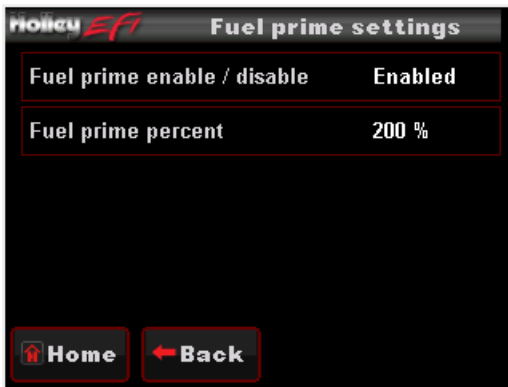

Figure 65

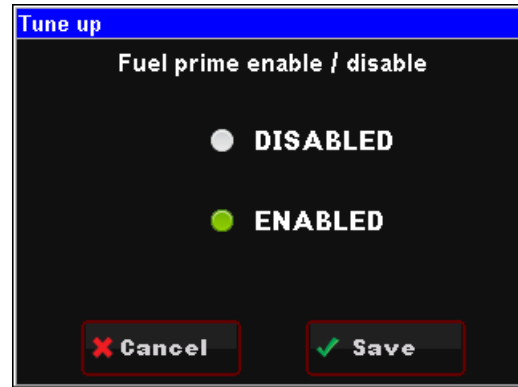

Figure 66

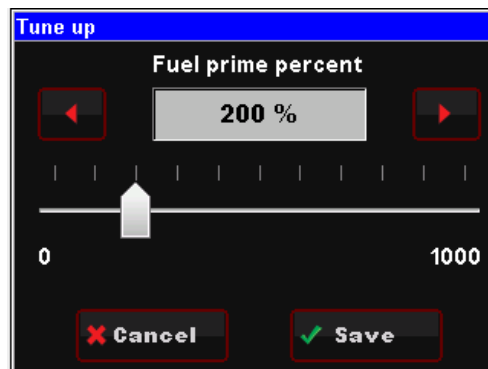

Figure 67

NOTE: This only injects fuel once at key-on, and will not do it again until the engine has run. This fuel prime occurs ½ of a second after key-on. If you quickly turn the ignition key without waiting for ½ a second, the prime will not occur and it may take longer for the engine to start.

30.2 Fuel Learn

30.2.1 Learn Enable/Disable

The LEARN Enable / Disable menu turns the Self Tuning “On” and “Off”. If enabled, self-tuning is performed. Learning should be enabled when an engine is just started and the tuning process is occurring. After the vehicle is driven under various operating conditions, and is running well, it is advised to disable learning, OR slow the Learn Speed to “Slow”.

30.2.2 Learn Speed

This parameter adjusts how fast the learning process occurs. In the beginning with a new tune it should be set to “Fast”. After the vehicle is driven under various operating conditions, and is running well, it is advised to disable learning, OR slow the Learn Speed to “Slow”.

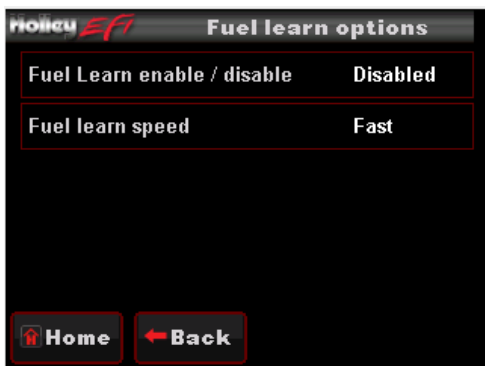

Figure 68

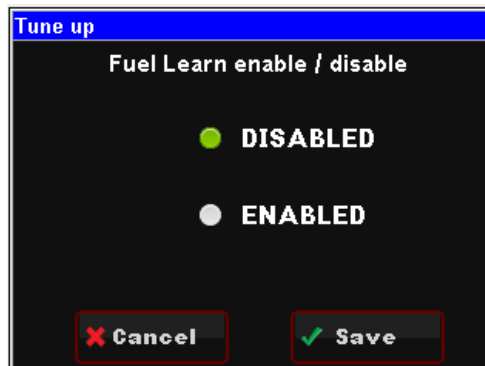

Figure 69



Figure 70

30.3 Basic Idle

Selecting BASIC IDLE allows you to change the Target Hot Engine Idle Speed. This should be adjusted to your desired idle RPM. Values between 650-800 rpm are typical. Larger camshafts or aftermarket torque converters may require a slightly higher value to maintain proper idle quality while in gear.

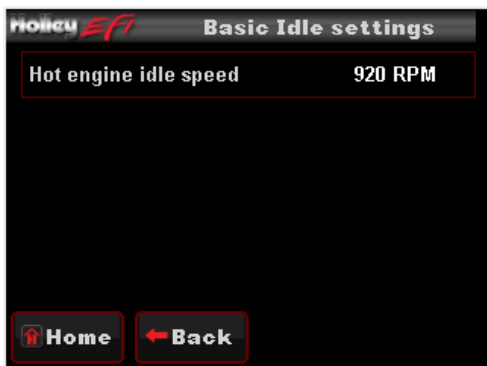

Figure 71

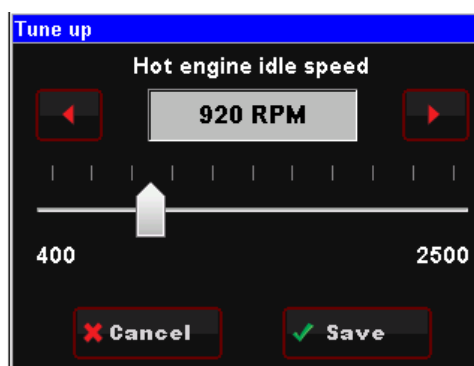

Figure 72

Selecting IDLE allows you to change the Target Idle Speed.

IDLE SPEED: Adjust the idle speed to what is desired.

30.4 Spark

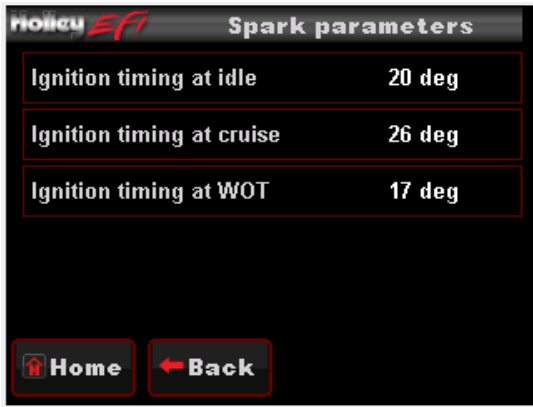

Figure 73

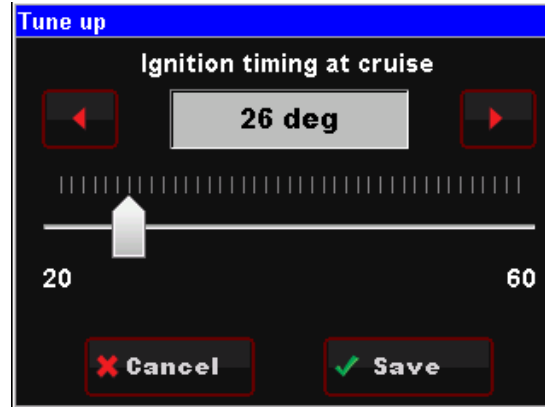

Figure 74

All Holley base tunes contain timing curves that will provide adequate engine operation, however the ignition timing at idle, cruise, and wide open throttle can be adjusted independently from each other to compensate for different engine combinations and geographical and climate extremes.

The following are typical values for each:

- **Idle Timing** – 18-34 degrees is typically used at idle. The larger the camshaft, the more timing is usually used.
- **Cruise Timing** – 32-48 degrees is typically used when cruising for optimal fuel economy.
- **Wide Open Throttle Timing (WOT)** – LSx applications typically don't use more than 28 degrees at WOT. Older V8 engines are usually between 32-38 degrees.

NOTE: Too much timing can cause pre-ignition that can damage an engine. Be cautious when tuning.

NOTE: The actual timing between IDLE, CRUISE, and WOT is blended together automatically. Consequently, the timing you see on the MONITOR screen, may not be exactly what you set for these settings. Changing these settings raises or lowers the "curve" of that specific area.

30.5 Transmission

NOTE: Caution must be used when modifying transmission parameters. Lowering line pressures too much can cause rapid wear and damage to the transmission. The base calibrations provided should provide a safe base calibration. If the transmission has very soft shifts or seems to slip, immediately stop to diagnose whether the problem is due to tuning or mechanical issues.

Selecting TRANSMISSION brings up the following menu. There are five areas you can modify; SHIFTS, WOT SHIFTS, TCC PARAMS, TCC (UN)LOCK, and LINE PRESSURE. These are reviewed below.

30.5.1 Shifts

Each Up-shift and Down-shift can be completely configured by selecting 'Shifts' from the transmission menu. Refer to section 18.1 (Making Adjustments) of this document for instructions on how to modify these curves.

Upshift/Downshift Tuning Notes:

- All Upshift points must occur at a higher speed than downshift. The touchscreen will give a warning and not allow this to occur if requested.
- Although it can be programmed with the handheld, the ECU won't allow a downshift to occur if it will over-rev the past the MAXIMUM RPM in the SYSTEM>TRANSMISSION>TRANS SETUP area.

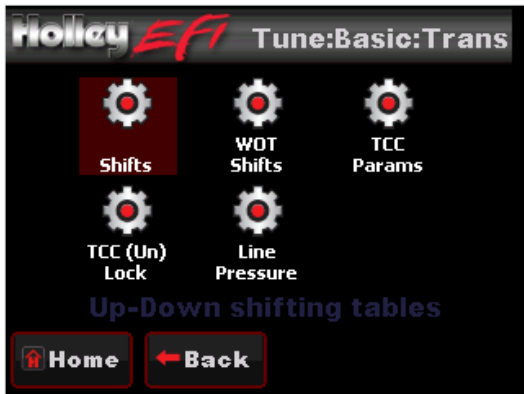

Figure 75

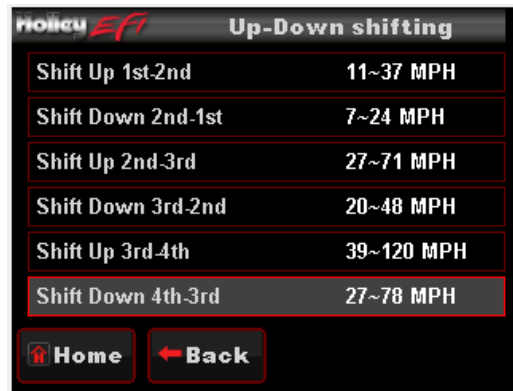

Figure 76



Figure 77

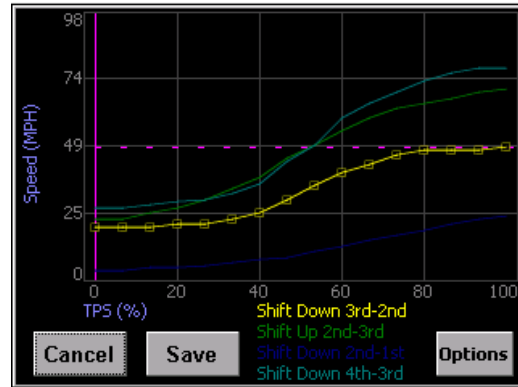

Figure 78

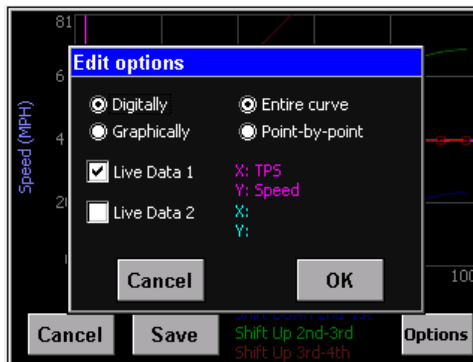

Figure 79

30.5.2 WOT Shifts

Use this menu to choose the RPM at which the transmission will upshift at WOT. Each gear change may be adjusted independent of the others.



Figure 80

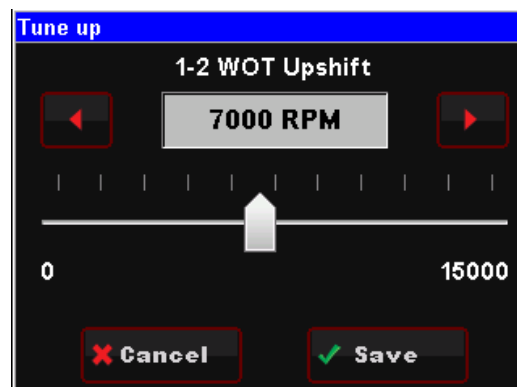

Figure 81

30.5.3 Torque Converter Clutch (TCC) Parameters

Contains parameters that tune TCC activation and deactivation.

- **Minimum RPM to Enable TCC** - Minimum engine speed at which the TCC will apply. This value can be adjusted so that engines with large camshafts do not hesitate surge if the TCC is applied at too low of an engine speed.
- **RPM to Disable TCC** - Used to unlock the TCC once it is locked. The Lock and Unlock values should not be too close together, or they will continuously lock and unlock. Applications with high stall torque converters will typically need 400-700 RPM or more between these values.
- **Maximum TPS TCC** - Throttle position value when the TCC will unlock. Most lockup torque converters do not have a clutch designed to lock up when higher power is being applied. It is best to unlock the converter under moderate to hard acceleration. Typically TPS values should be between 25-50%.
- **TCC Disable** - When enabled, the TCC will never lock up.

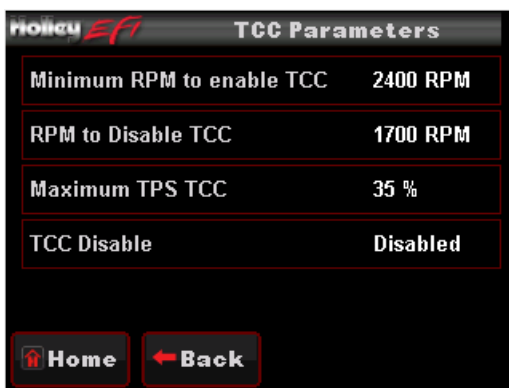

Figure 82

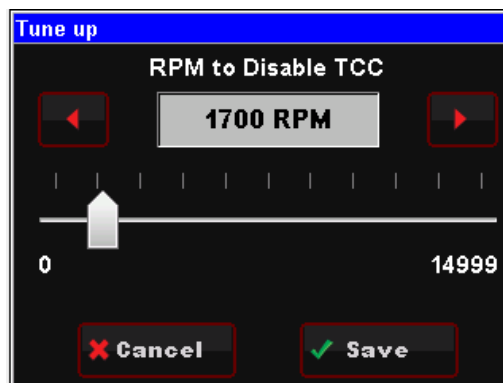

Figure 83

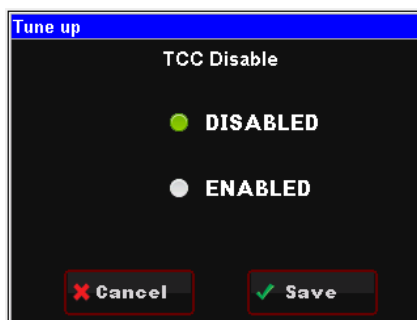

Figure 84

30.5.4 Torque Converter Clutch (TCC) (Un) Lock

These parameters work in addition to the TCC Parameters by offering additional tuning based on vehicle speed. This keeps the TCC from locking up during 'around-town' driving if it is not desired. The Lock values should always be higher than the Unlock values. Adjustments to these can be done by using the graph.

NOTE: See instructions for changing data in the GRAPH screen in the 'Making Adjustments' section.

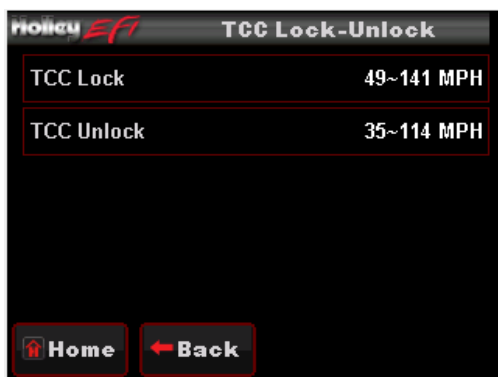

Figure 85



Figure 86

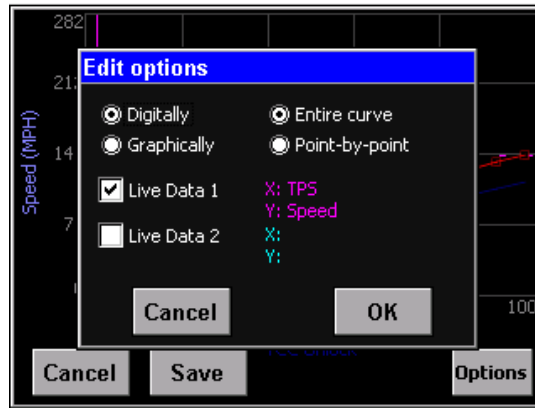

Figure 87

30.5.5 Line Pressure

Tune the line pressure vs. TPS or MAP for each gear. A lower duty cycle (moving towards 0%) increases line pressure with 0% providing maximum line pressure applied. Values above 40-50% typically result in a line pressure too low for any throttle position, which may result in transmission damage.



Figure 88

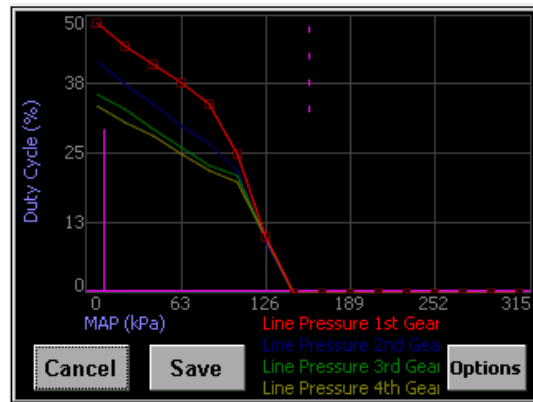

Figure 89

31.0 SYSTEM SETUP

31.1 System Tuning

From the HOME MENU, select TUNING, and SYSTEM. There are four areas you can modify; OUTPUTS, ENGINE SETUP, IGNITION SETUP, and TRANSMISSION.

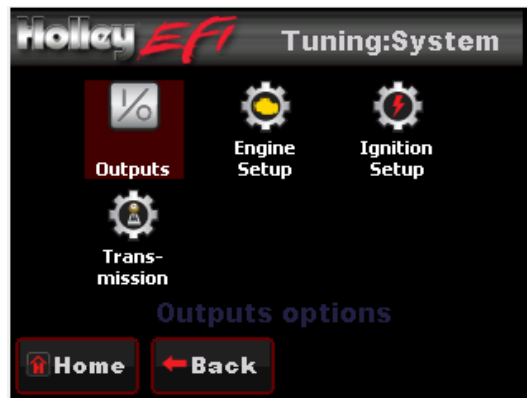

Figure 90

31.1.1 Outputs

The OUTPUT screen allows for the Fan #1 and Fan #2 ON and OFF temperatures to be adjusted. The ON temp needs to always be a higher value than the OFF temp. Use a difference of at least 5 degrees so they aren't cycling excessively. In Terminator Kits these are ground outputs that should be wired to trigger the fan relays. NEVER wire them directly to the fans! The AC Disable value is a TPS value above which a 12 volt output is sent out to deactivate the air conditioning compressor at wide open throttle.

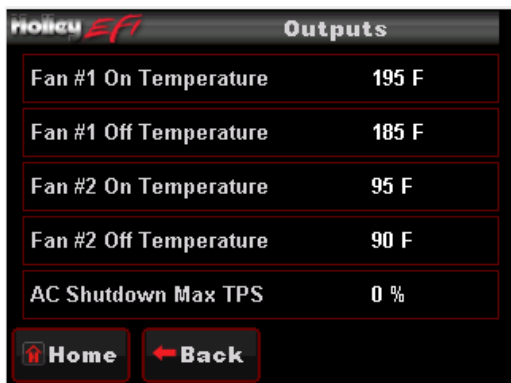

Figure 91

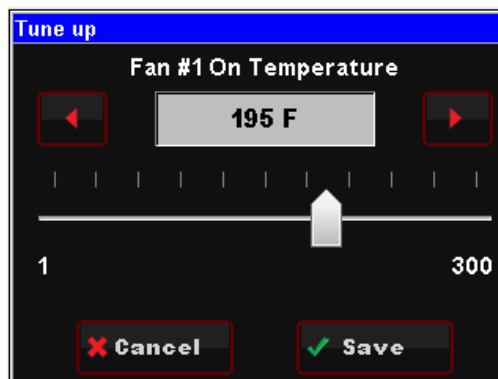

Figure 92

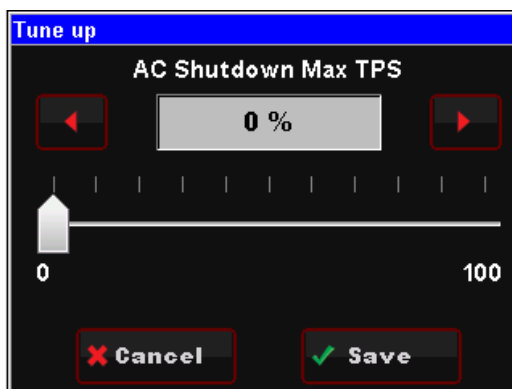

Figure 93

31.1.2 Engine Setup

These parameters should all be properly pre-set when you went through the Wizard process. If you change something on your engine, or run a different system fuel pressure or injector size, they can be edited here

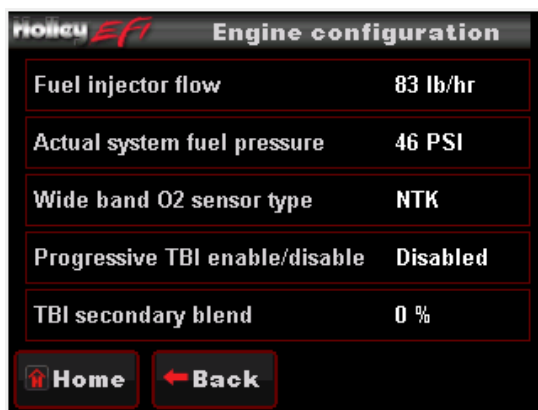

Figure 94

Fuel Injector Flow: Adjust fuel flow injector ratings to match what is installed on the engine

Actual System Fuel Pressure: Enter the actual fuel system pressure for accurate fuel map & logging data.

Wide Band O2 Sensor Type: Selects the type of wide band oxygen sensor used. If the software selection does not match the sensor being used damage to the WBO2 sensor will occur.

Progressive TBI Enable/Disable: This should be selected if using a TBI throttle body with progressive throttle linkage. All 4 BBL TERMINATOR™ TBI systems do NOT have progressive linkage, so this should not be checked. This will NOT be shown if you have selected a MPFI application.

TBI Secondary Blend: If using a TBI with progressive linkage, this value is used to start the ramp-in of the secondary fuel injectors as the rear throttle plates open. Enter the TPS when the rear throttle plates start to open. This is typically 36% for a Holley throttle body unit. The “Check for Progressive Throttle Linkage” must be checked for this box to be enabled. This will NOT be shown if you have selected a MPFI application

NOTE: Holley MPFI and TERMINATOR™ injector size/flow is calculated at 43 PSI.

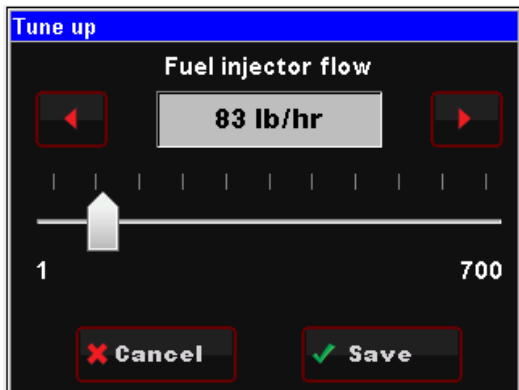

Figure 95

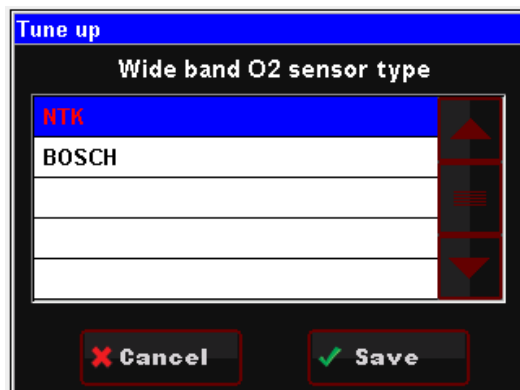

Figure 96



Figure 97

31.1.3 Ignition Setup

There are two parameters that are adjustable in the IGNITION SETUP. Ignition input type and engine rev limiter.

REV LIMIT – The rev limiter is only enabled when using a computer controlled small cap GM HEI. It is an ignition-only rev limiter. It will not shut fuel off. Enter a value for which you'd like the rev limiter to start.

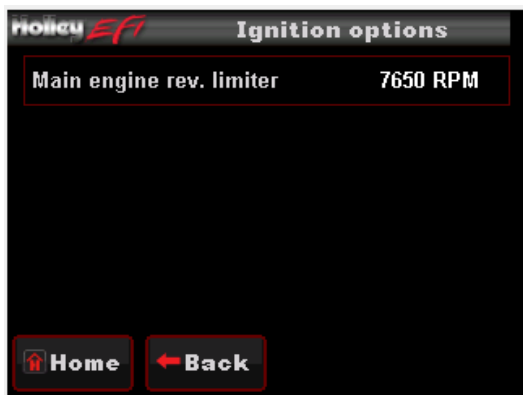

Figure 98

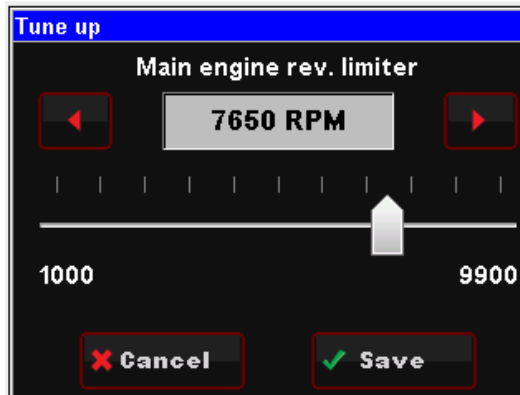

Figure 99

NOTE: MPFI and TERMINATOR™ injector size/flow is calculated at 43 PSI. TBI injector size/flow is calculated at 21 PSI.

32.0 ADVANCED TUNING

From the HOME MENU, select TUNING, and ADVANCED. There are four areas you can modify; ADV FUEL, CLOSED LOOP, ADV. LEARN, AND ADV. IDLE. These are reviewed below.

The Advanced Tuning areas typically won't ever be needed to be changed. However, after getting used to the TERMINATOR™ EFI system, there may be some fine tuning of various parameters that you'd like to perform.



Figure 100

32.1 Advanced Fuel

- **Coolant Enrichment:** Coolant enrichment is similar to the choke on a carburetor. Adjustments are made as a percentage of the base map from 100% to 150%. 100% would mean no additional fuel is being added by the Coolant Enrichment, 110% would mean that an additional 10% of fuel is being added to the base fuel map which will decay back to 100% in relation to actual engine coolant temperature.
- **Load Based Acceleration Enrichment:** This parameter provides another way of adding fuel when the accelerator is depressed. It adds fuel depending on how fast the MAP sensor reading changes (detects a change in engine load). There is typically no need to adjust this parameter except possibly under some extreme conditions of vehicles that are heavy and under-powered. Adjustment values are in pounds of fuel per hour (pph) and should initially be adjusted in increments of 5-10 pph
- **Cranking Fuel:** This dictates how much fuel is injected when the engine is cranking and is dependent on coolant temperature. Changing this value offsets the entire curve at all temperatures. Adjustment values are in pounds of fuel per hour (pph) and should initially be adjusted in increments of 2-4 pph.
- **Afterstart Fuel:** The afterstart parameter is fuel that is added for a short time immediately after an engine starts. This value varies depending on engine temperature. Changing this value offsets the entire curve at all temperatures. Adjustments are made as a percentage of the base map from 75% to 200%, 100% would mean no additional fuel is being added, 110% would mean that an additional 10% of fuel is being added to the base fuel map, and 85% would mean that 15% of fuel is being taken away from the base map. All selections will decay back to 100% over a predetermined amount of time.

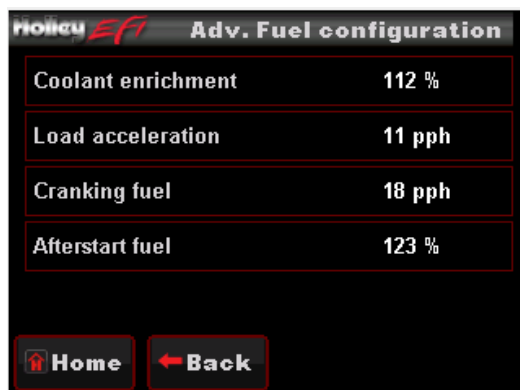

Figure 101

32.2 Closed Loop

CLOSED LOOP OPERATION relies on WBO2 sensor readings. The Holley EFI system uses these readings to analyze 'real time' running conditions. The data obtained by the ECU is then used trim fuel flow to achieve the targeted air fuel ratio (AFR).

Choosing CLOSED LOOP from the ADVANCED TUNING menu will allow you to modify four areas of the CLOSED LOOP operation.

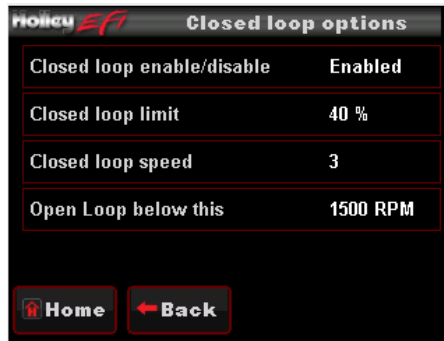

Figure 102

- **Closed Loop Enable/Disable:** This menu enables or disables closed loop operation. There is typically no reason to turn off closed loop operation unless you suspect an oxygen sensor problem and want to disable the sensor. **Note:** Self-Tuning requires closed loop operation to function.
- **Closed Loop Limit:** The maximum percentage the ECU is allowed to deviate (+/-) from the base fuel calibration in order to maintain the commanded target air fuel ratio. This is set to 100% by default and under most circumstances should not need to be changed.
- **Closed Loop Speed:** This is the “speed” (gain) at which closed loop operation occurs. This can be set to five levels, 1, 2, 3, 4, or 5. 3 is the base setting and should be good for most applications. 4 or 5 is typically not used as the closed loop speed may be too excessive for certain applications. If the oxygen sensor is installed far back in the exhaust (more than 1 foot back from the collector in long tube headers), a value of 1 or 2 may be needed.
- **Open Loop Below This:** This setting is usually zero. If an extremely large camshaft is used (specs only typically found on race camshafts), the overlap sometimes causes a “false lean” reading at low RPM. In these cases, it may be required to put in a value of 1500-2000 RPM so the system operates open loop below this RPM setting.

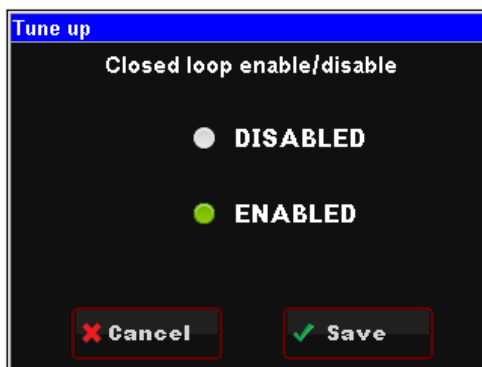

Figure 103

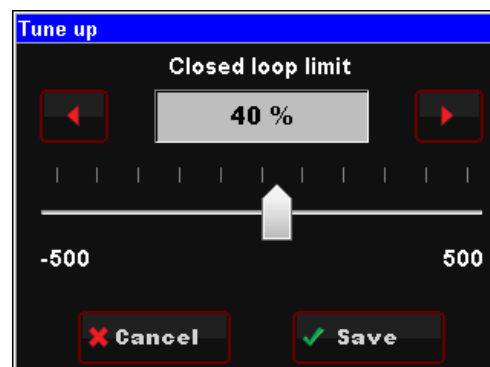

Figure 104

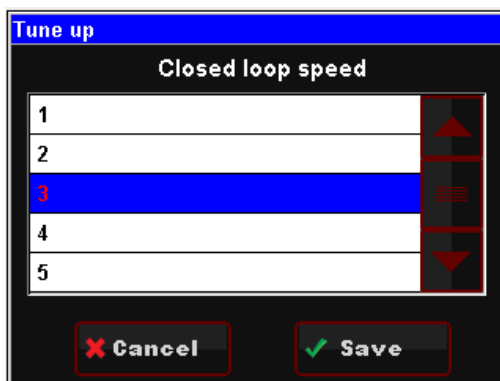

Figure 105

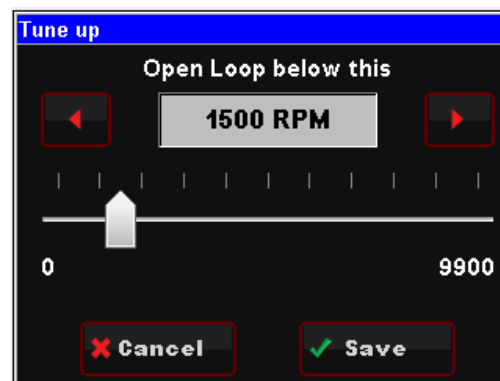

Figure 106

32.3 Advanced Learn

Choosing ADVANCED LEARN will allow you to modify the LEARN COMPENSATION LIMITS. This value is set to 100% by default, and should remain there until ample driving time and tuning has occurred. The LEARN COMPENSATION LIMIT is a parameter that ECU is allowed to work within when making changes to the fuel map based upon CLOSED LOOP operation. Unlike the CLOSED LOOP LIMIT which is a set parameter for commanded changes to actual fuel flow based upon the O2 sensor reading, LEARN COMPENSATION LIMITS are the percentage of change that is allowed to actually be saved as a modifier to the fuel map.



Figure 107

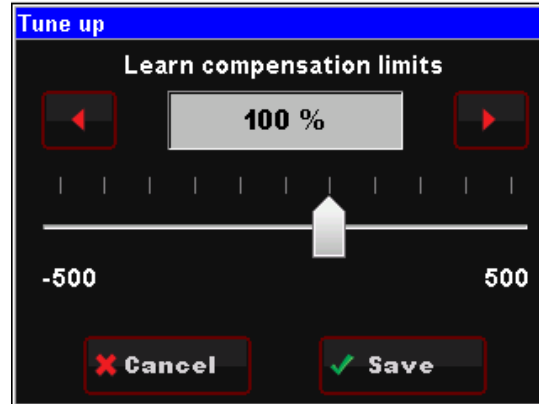

Figure 108

32.3 Advanced Idle

The ADVANCED IDLE parameters adjust specific characteristics of how the idle air control motor functions on engine decel and startup.

Selecting ADVANCED IDLE brings up the following menu:



Figure 109

32.3.1 IAC Rampdown

The Idle Air Control (IAC) motor is a stepper motor located in the throttle body that controls the idle speed of the engine by metering air. It also operates during engine cranking and when the engine returns back to idle. The following settings can adjust how that functions. The IAC moves from a position of 0% (fully closed, no air added) to 100% (fully open, maximum air flow).

NOTE: Contact Holley Tech Support if you have any questions regarding IAC settings.

Selecting IAC RAMPDOWN brings up the following menu with four choices, IAC HOLD POSITION, IAC RAMP DECAY, IAC RAMP START, and IAC KICK. These are reviewed below:

- **IAC Hold Position:** This is the position the IAC motor will “hold” or “freeze” at when the TPS moves above idle (when TPS becomes greater than 0%). If it is too high, the engine RPM will “hang” and not return to idle.
- **IAC Ramp Decay:** This is the time (in seconds) it takes for the IAC to decay from the “IAC Hold Position” back to a “0%” position. It is a linear decay.
- **IAC Ramp Start (RPM above idle):** This value is the RPM added to the target idle speed that the IAC will automatically start to ramp back down to idle. If this is too low, the engine RPM will “hang” and not return to idle.
- **IAC Kick:** The IAC Kick provides a temporary increase in IAC position to keep engine the RPM from dropping. Typically this is used in conjunction with an A/C system keep the engine speed from ‘dipping’ as the compressor cycles on and off.

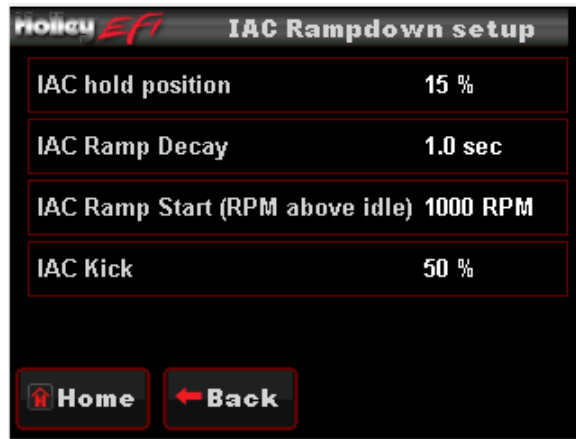

Figure 110

32.3.2 IAC Speed

This menu is used to select the type of IAC motor application that is being used. This selection drives the background parameters that control the IAC motor. These parameters have been fine tuned for each of these applications, eliminating the need for the user to perform further modifications

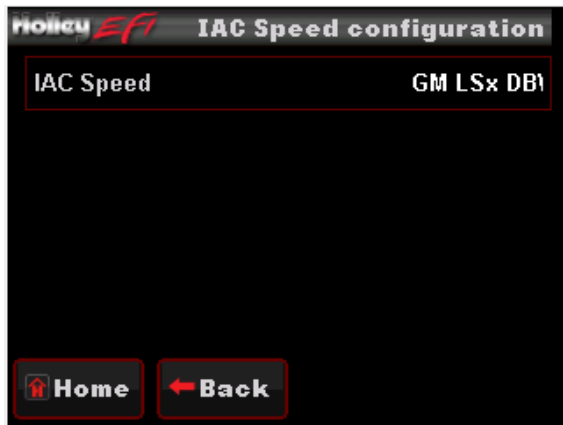

Figure 111

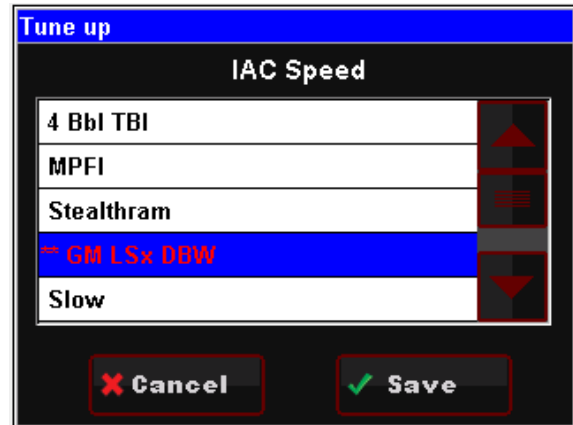

Figure 112

32.3.3 IAC Startup

These parameters control the position of the IAC when the engine is cranking and immediately after it starts.

Selecting IAC STARTUP brings up the following menu with three choices, IAC PARKED POSITION (CRANKING), IAC STARTUP HOLD TIME, and IAC STARTUP DECAY TIME.

- **IAC Parked Position (Cranking):** This is the position the IAC motor will be at during cranking and immediately after the engine starts. If it is too high, the engine will be at too high of an RPM once it starts. Too low and poor starting will result. Note that this is a temperature based table. The percentage value changed in the handheld offsets this entire curve.
- **IAC Startup Hold Time:** This is the amount of time that the IAC will remain at the “IAC Parked Position”.
- **IAC Startup Decay Time:** This is the amount of time for the IAC to decay from the “IAC Parked Position” back to its “Target Idle” position. It is a linear decay.



Figure 113

32.3.4 Idle Spark

Idle spark is a feature active only when the ECU is controlling timing. When enabled, the ECU modifies commanded timing at idle to help maintain the target idle speed.

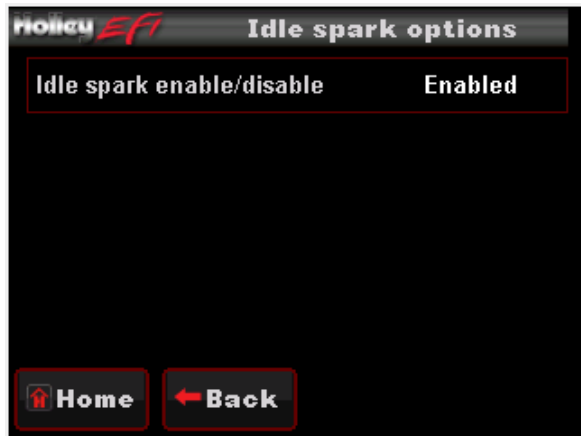

Figure 114



Figure 115

NOTE: This feature should be disabled when checking base timing with a timing light! If not disabled rev the engine to approximately 2000 RPM when syncing timing.

APPENDIX 2.0 SENSOR DIAGNOSTICS AND STATUSES

Sensor diagnostics are included in the handheld. If one of the main sensors has some type of error, a small, blinking red circle will appear in the upper right of the screen. To navigate to the diagnostics, select MONITOR and DIAGNOSTICS. If there is an issue, an error will also be shown on any of the MONITOR or GAUGES screens.

Wideband Oxygen Sensor Status – Shows status of wideband oxygen sensors.

Text	Description
...	Signifies that sensor channel is not enabled.
Init..	First shown for an instant when the system is powered on. Displayed so quickly you will likely not see this.
Heating	Sensor is heating.
Cold!	Sensor is below calibrated operating temperature. Unit will still read but accuracy may be impacted.
Hot!	Sensor is above calibrated operating temperature. Unit will still read but accuracy may be impacted.
Unplgd	Sensor is unplugged.

General Sensor Status – These are shown for the coolant and air temperature, MAP, TPS, Oil and Fuel pressure sensors. If you do not have an oil or fuel pressure sensor installed, you will see this error. It will not cause a problem.

Text	Description
Undefnd	Unlikely failure indicated that a sensor is not properly defined.
LOW Err	A sensor displaying this can be unplugged, have an open or short circuit, or be otherwise damaged.
HI Err	A sensor displaying this can be unplugged, have an open or short circuit, or be otherwise damaged.

RPM (Crank Signal Inputs) Diagnostics – The following are shown for the “RPM” parameter which indicates the status of the crank sensor/engine speed input.

Text	Description
Stall!	No RPM input detected.
Syncng	Signal detected. Position being established.
Nothing	Will show briefly after crank signal and cam/crank positions established. Actual engine RPM will then be indicated.
Error!	Cam/Crank input error detected.

TPS Diagnostics – The following are shown for the “TPS” parameter.

Text	Description
Error!	If you see an error, contact Holley Tech Service.
NeedCal	TPS Autoset needs to be performed.

Closed Loop Diagnostics – Shows status of closed loop operation.

Text	Description
OpenLp	System is in open loop operation.
CloseLp	System is in closed loop operation.

Learn Status – Shows status of learn mode.

Text	Description
NoLearn	Learning is not active.
Learnng	Learn is in an active state.

Switched Inputs/Outputs Status – Shows status of switched inputs and outputs.

Text	Description
OFF	Input or Output is not active.
ON	Input or Output is active.

DESCRIPTION	COLOR	WIRE GAUGE	PIN
INJECTOR POWER	BLACK/RED	18 GA	A
INJECTOR 1	BLACK/YELLOW	20 GA	B
INJECTOR 2	BLACK/WHITE	20 GA	C
INJECTOR 3	BLACK/GRAY	20 GA	D
INJECTOR 4	BLACK/LIGHT GREEN	20 GA	E
IAC A LO	BLACK/DARK GREEN	22 GA	F
IAC A HI	BLACK/LIGHT BLUE	22 GA	G
IAC B LO	BLACK/DARK BLUE	22 GA	H
IAC B HI	BLACK/PINK	22 GA	J
MAT INPUT	BLACK/TAN	22 GA	K
TPS INPUT	BLACK/BROWN	22 GA	L
MAP INPUT	BLACK/PURPLE	22 GA	M
SENSOR +5V REF	BLACK/ORANGE	22 GA	N
SENSOR GROUND OUT	BLACK	22 GA	P

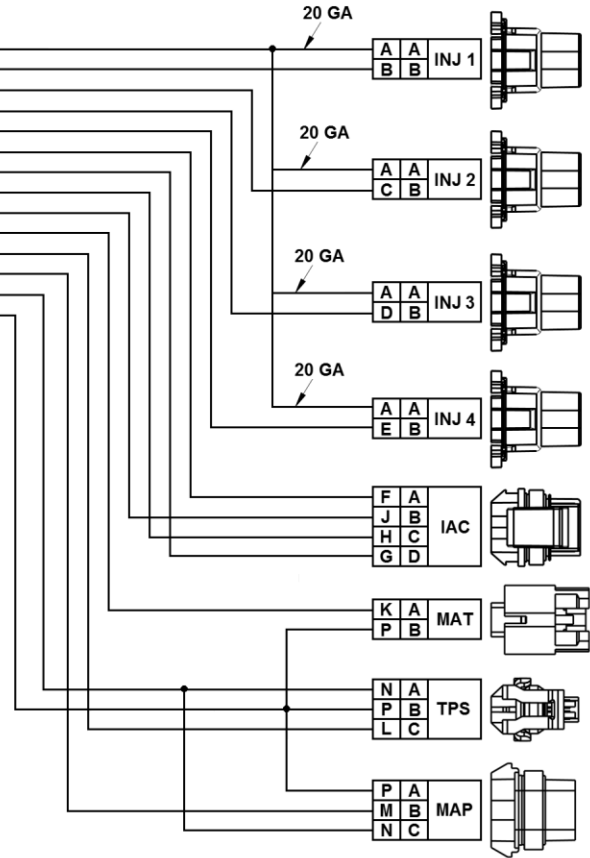

Figure 116

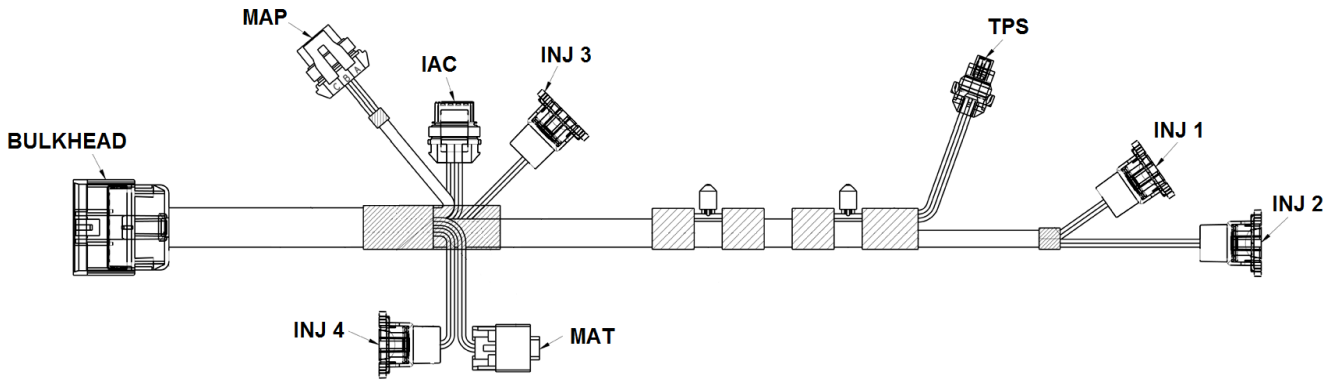

Figure 117

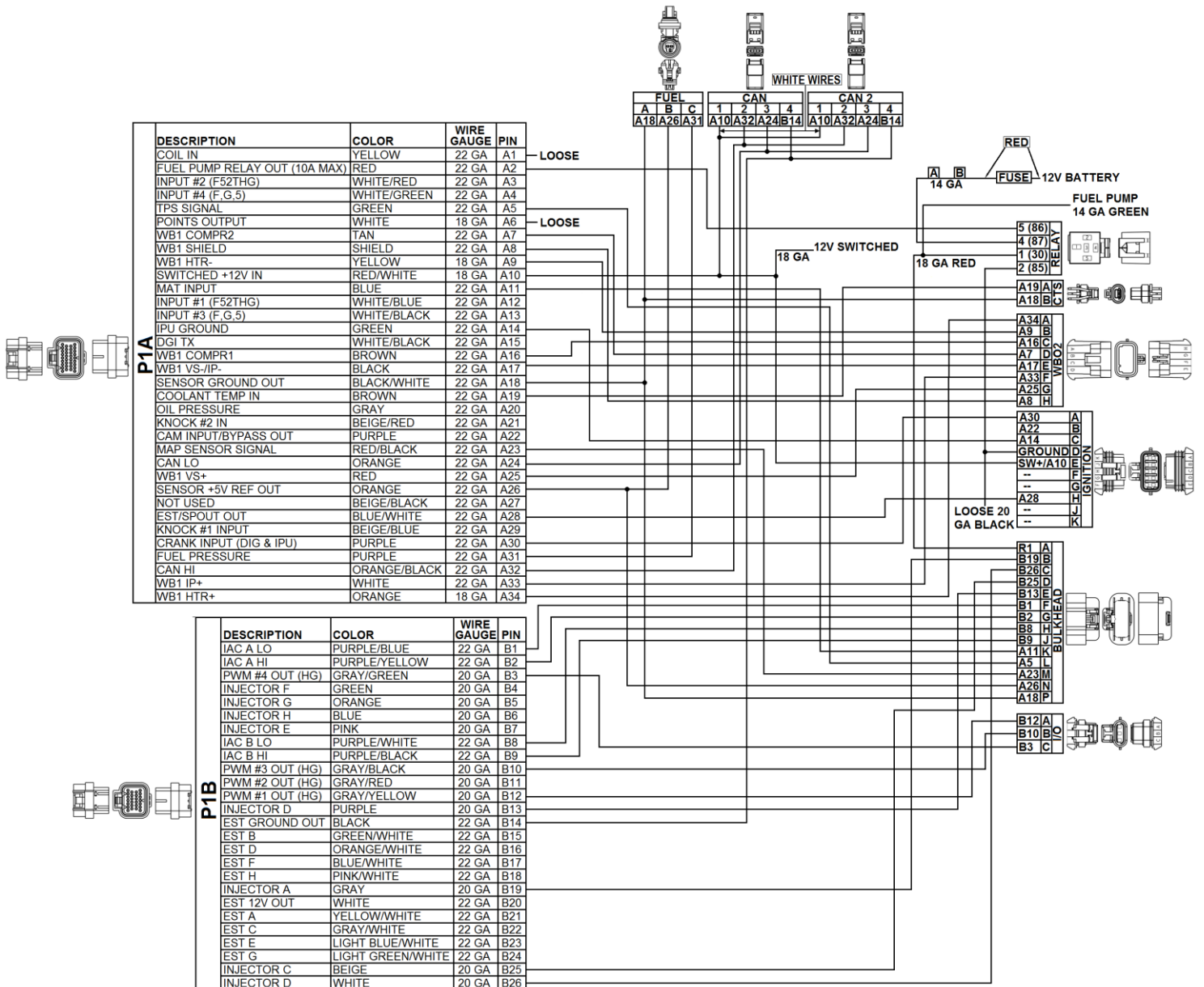

Figure 118

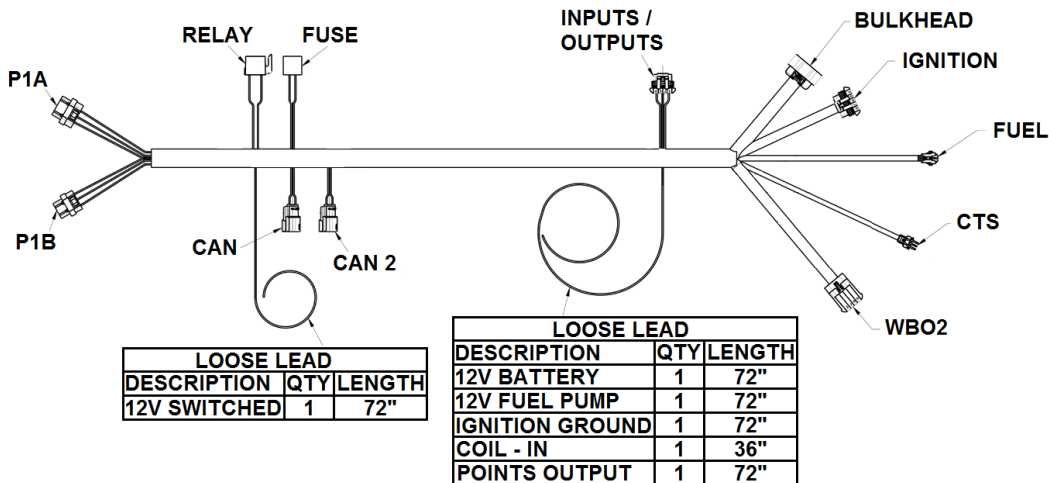

Figure 119

271R974A GM 4L60-4L80E TRANSMISSION HARNESS

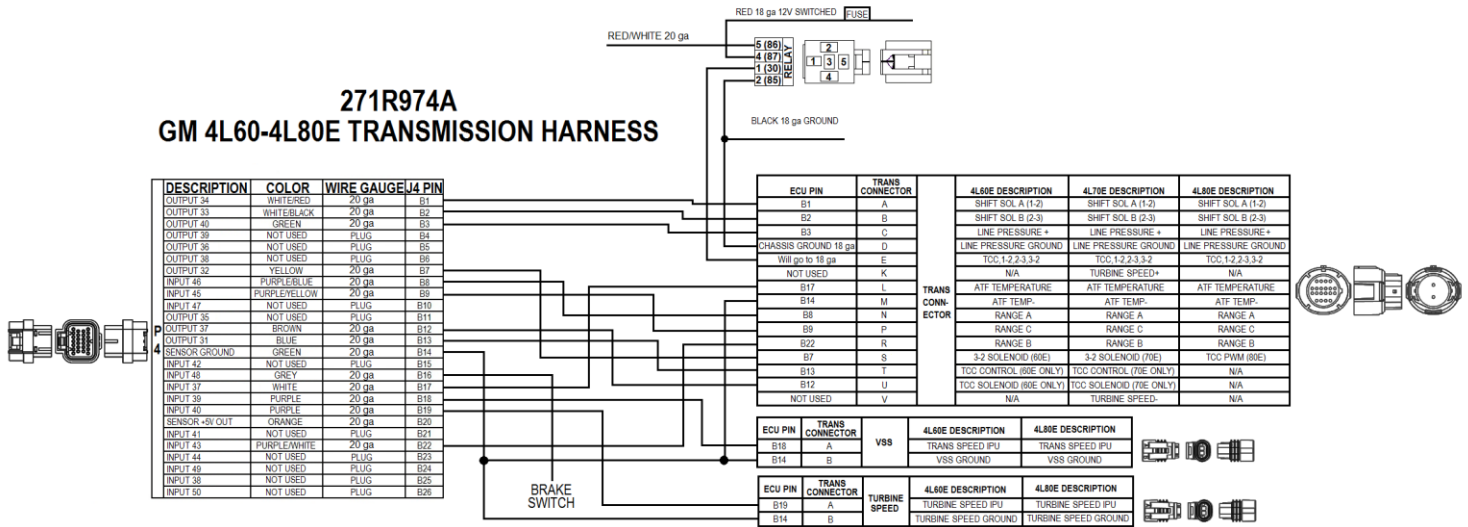

Figure 120

271R974A GM 4L60E-4L80E TRANSMISSION HARNESS

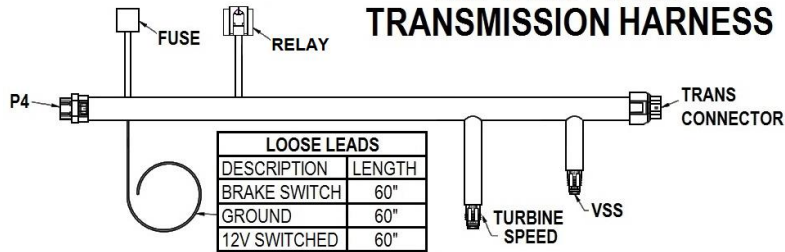

Figure 121

Holley Technical Support: 270-781-9741

199R11137
Revision Date: 1-24-19