



REPLACEMENT CARBURETOR - MODEL 4160 P/N 0-8007 Installation and adjustment Instructions

WARNING! These instructions must be read and fully understood before beginning installation. Failure to follow these instructions may result in poor performance, vehicle damage, personal injury, or death. If these instructions are not fully understood, installation should not be attempted.

APPLICATIONS:

The Model 4160 P/N 0-8007 is calibrated for use on V-6 and small V-8 engines. This carburetor is a "square" flange carburetor and should **NOT** be used with adapters on "Spread-Bore" type manifolds, since adapters on may affect cylinder-to-cylinder fuel distribution. On some applications, it may be necessary to modify the throttle lever for proper operation of the throttle linkage and transmission kickdown linkage.

NOTE: The 0-8007 is not designed to pass any emission laws. The 0-8007 is to be used only for competition/off road vehicles or vehicles not required to comply with any exhaust emissions standards.

INTRODUCTION:

Holley Performance Products cannot and will not be responsible for any alleged or actual engine or other damage, or other conditions resulting from misapplication of the carburetor described herein. However, it is our intent to provide the best possible products for our customer; products that perform properly and satisfy your expectations. Should you need information or parts assistance, please contact our Technical Service Department at 1-270-781-9741, Monday through Friday, 8 a.m. to 5 p.m. Central Time; please have the part number of the product you purchased when you call.

REMOVAL OF OLD CARBURETOR:

WARNING! Prior to and after installing your new carburetor, manually operate the throttle lever, checking for any sticking or binding. Failure to do so may result in a runaway engine or a wide open throttle condition, which could result in engine damage, personal injury, and/or death.

NOTE: Make a visual inspection of the carburetor, looking for any missing parts, bent levers, or any possible shipping damage.

1. Remove the air cleaner.
2. Label all connections to the carburetor such as: fuel line, PCV vacuum and spark - distributor vacuum.
3. After labeling all connections to the carburetor, carefully disconnect all hoses and lines. When removing the fuel line, slide a rubber cap plug over the end to prevent fuel from running out, which may create a fire hazard. Use a clean metal container to collect any spilled fuel.

DANGER! DO NOT SMOKE WHEN WORKING AROUND GASOLINE OR GASOLINE VAPORS. EXTINGUISH ALL OPEN FLAMES. AN OPEN FLAME, SPARK, AND/OR EXTREME HEAT COULD RESULT IN A FIRE AND/OR EXPLOSION CAUSING SERIOUS INJURY, DEATH, AND/OR PROPERTY DAMAGE.

4. Disconnect any choke rods or heat tubes.
5. Remove the throttle linkage and automatic transmission controls from the throttle lever. Disassemble and save the throttle return springs and retaining clips.
6. Remove the two front and two rear attaching manifold flange nuts. Remove the throttle cable bracket, if so equipped, (located at the right rear attaching bolt). Remove the carburetor by lifting it straight upward. Sometimes the carburetor can stick to the manifold gasket, requiring it to be pried loose. Before prying, double check to make sure all the carburetor attaching bolts and connections have been removed.
7. Place clean shop towels or rags into the manifold opening to prevent dirt or debris from entering the engine. Keep exposed ends of vacuum and fuel lines free from dirt.

WARNING! Failure to cover the intake opening with a clean towel could result in dirt or debris entering the engine. Dirt or debris in the induction system can cause engine damage which may necessitate in a complete engine overhaul.

8. Remove the gasket from the intake. Remove any gasket material that may have adhered to the manifold. **DO NOT** gouge the intake manifold sealing surface during removal of old gasket material.
9. Remove the shop towels from the intake and vacuum out the intake channel to ensure no dirt or debris is left in the intake system. Place a clean shop towel over the entire intake opening until you are ready to install the new carburetor.
10. Remove the throttle cable ball and automatic transmission kickdown stud (if any) from the old carburetor, and mount on the Holley lever (some modifications to lever may be necessary for some installations). A full assortment of throttle balls can be purchased under Holley P/N 20-2.

PREPPING THE CARBURETOR FOR INSTALLATION:

Before installing the new carburetor, it is necessary that parts be added on certain applications. Find your application below and follow the instructions to prepare your carburetor for final installation.

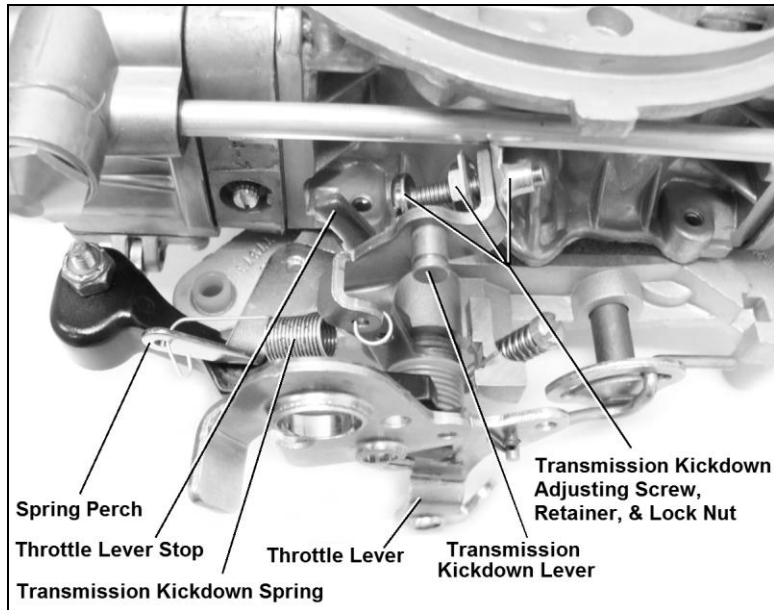

Figure 1

Ford Application with Automatic Transmission:

NOTE: Holley P/N 20-91, transmission kickdown spring & bracket kit, is required for Ford automatic transmission applications.

1. Remove the lockout screw from the kickdown actuating lever.
2. Install the transmission adjusting screw, lock nut, and retainer. See Figure 2.
3. Fasten the spring perch from the unassembled parts using the Phillips Head Screw in the unassembled parts as shown in Figures 2 and 3. Make certain that the locating pin on the perch is in the hole of the throttle body.
4. Install the transmission kickdown spring between the kickdown lever and the spring perch. See Figure 3.
5. Hold the carburetor throttle in the extreme wide open position and back out the transmission kickdown screw until it just contacts the tang on the throttle stop lever. Re-check this when the carburetor is on the car.

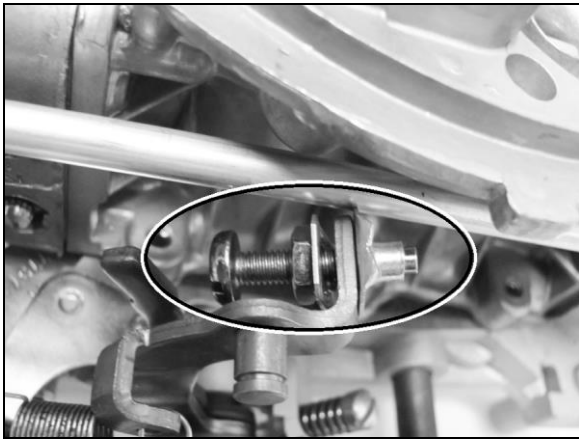

Figure 2

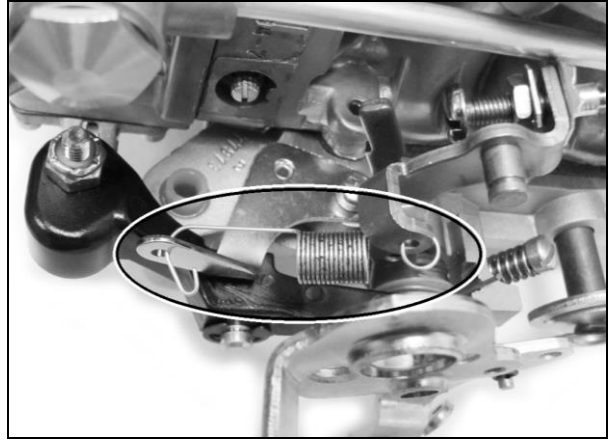

Figure 3

Ford Application with Manual Transmission:

If the vehicle is equipped with a manual transmission, additional parts are not required.

Chrysler Application with Manual or Automatic Transmission:

A Chrysler throttle lever extension P/N 20-7 should be purchased and installed according to packaged instructions.

GM Application with Automatic Transmission:

Remove the throttle cable and automatic transmission kickdown stud (if any) from the original carburetor and mount these in similar locations on the Holley throttle lever. If the original throttle cable ball is too large, different size throttle balls can be purchased under P/N 20-2. GM applications with a TH-700R4 transmission require Holley P/N 20-95 transmission bracket kit and 20-121 throttle lever adapter.

GM Application with Manual Transmission:

If the vehicle is equipped with a manual transmission, additional parts are not required.

FLUSHING THE FUEL LINES:

During fuel line installation be careful to avoid introducing any dirt particles which could enter the fuel inlet and jam open the needle and seat resulting in the carburetor flooding, malfunctioning and/or possible engine fire. In all cases where the fuel line has been cut, it is essential that if be cleaned to prevent contamination from entering your new carburetor, the fuel line must be flushed of rust, dirt and other debris.

WARNING! Holley DOES NOT recommend the procedure where the coil wire is disconnected, the engine cranked for a few revolutions, and the fuel is collected in a container. This procedure is unsafe because sparking can occur either at the coil, or at the distributor end of coil wire, which may ignite any fuel spilled in the engine compartment.

1. Disconnect the fuel line at the fuel pump.
2. Using a compressed air source, blow the fuel line clean.

DANGER! FLUSH FUEL LINES ONLY IN A WELL-VENTILATED AREA AND AWAY FROM ALL SOURCES OF HEAT OR FLAME. FAILURE TO FOLLOW THESE INSTRUCTIONS MAY CAUSE GASOLINE VAPORS TO IGNITE RESULTING IN A FIRE OR EXPLOSION, WHICH MAY RESULT IN SERIOUS INJURY AND/OR DEATH.

WARNING! Wear eye protection when performing this step. Failure to wear eye protection can result in gasoline or other contaminants entering the eye, which could result in permanent eye damage and/or blindness.

INSTALLATION OF THE NEW CARBURETOR:

WARNING! Holley Performance Products highly recommends that a quality fuel filter be installed with any replacement carburetor to catch any dirt that may still remain in the system. Any dirt that may enter the carburetor can cause the carburetor to flood or malfunction. A carburetor that has a malfunction caused by dirt in the system due to negligence of the owner will void the warranty.

1. Remove the shop towel from the intake manifold and install a flange gasket on the manifold.
2. Place the carburetor in position over the four stud bolts on the flange gasket. Install the hold-down nuts and tighten progressively in a criss-cross pattern to 60 in./lbs. Be careful not to over tighten the nuts.

WARNING! Over tightening the carburetor manifold flange hold-down-nuts may result in a warped or cracked carburetor throttle body. The carburetor hold down nuts should be tightened down progressively in a criss cross pattern to 60 in./lbs., so that vacuum leaks are prevented and to avoid causing damage to the throttle body. A carburetor that has been damaged due to negligence of the owner will void the warranty.

3. Reconnect the throttle and transmission kickdown linkage.
4. Reconnect the throttle (and kickdown if equipped) return springs.
5. Operate linkage to assure correct throttle travel from wide open throttle position to the closed or return position. Operate the accelerator pedal from inside the vehicle and have someone check to assure complete opening of throttle plates under the hood. Readjust throttle cable, if necessary.

WARNING! Check assembled linkage for sticking and/or binding throttle action by holding primary open and manually operating the secondaries. Any sticking, binding or other interference in the throttle linkage could result in uncontrolled engine speed.

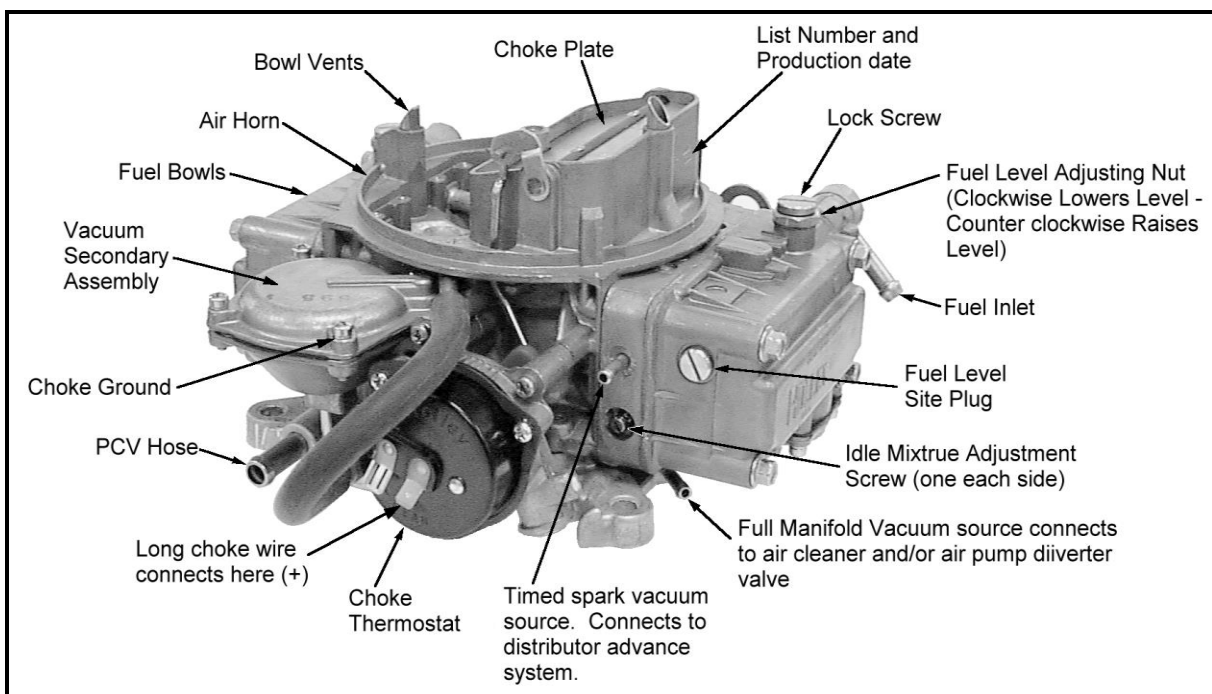

Figure 4

6. Reconnect all vacuum lines and electronic wires that were labeled in the removal of the old carburetor. Use Figure 4 as a guide to locate connections. The full manifold vacuum source in the front of the throttle body provides vacuum for proper operation of the air cleaner, the air pump diverter valve (if the vehicle is so equipped) and/or the temperature sensing valve. The timed spark fitting in the choke side of the primary metering block provides vacuum for operation of the distributor vacuum advance. Connect the hose to the distributor, spark delay valve and/or temperature sensing valve. If vacuum for more than one component is needed plastic "T's" (available at most automotive part stores) maybe used to complete the installation.
7. Connect the PCV hose to the PCV fitting in the carburetor. See Figure 4. If the intake manifold has no provision for power brakes, the power brakes hose can be "Tee'd" to this fitting. Connect solenoid wire to the original source wire.
8. Connect fuel line to carburetor. This carburetor is equipped with a 5/16" flared tube fitting and proper connection can be made using a length of fuel resistant rubber hose and clamps.

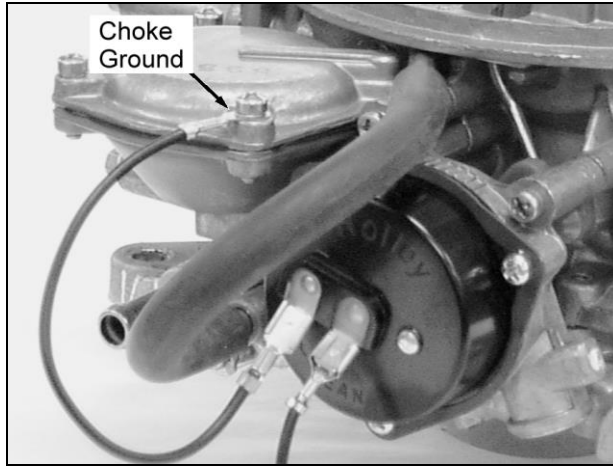

Figure 5

WARNING! This carburetor DOES NOT contain inline moraine fuel filters. Therefore, the use of a quality inline fuel filter such as Holley P/N 162-524 is MANDATORY to provide extra protection against possible flooding which could result from unfiltered foreign particles becoming lodged between the fuel inlet needle and its seat. This can result in a fire if a spark is present or a backfire occurs. Filter elements should be blown clean with compressed air at 6,000 miles, and replaced at 12,000 miles to assure maximum protection.

9. This carburetor is equipped with an electric choke. One short and one long wire will be found in the enclosed parts pack. The short wire should be connected to the negative (-) terminal on the choke cap and the other end secured to a ground, such as under the head of one of the screws retaining the secondary throttle diaphragm cover. The long wire should be secured to the positive (+) terminal on the choke cap, with the other end connected to an ignition activated 12V source. The ignition coil is not a 12 volt source after cranking, it is a 7-9V source after cranking. See Figure 6.

DANGER! OBSERVE CORRECT POLARITY WHEN CONNECTING ELECTRIC CHOKE WIRES. CONNECTING THE POSITIVE (+) LEAD TO GROUND, AND THE NEGATIVE (-) LEAD TO A 12V SOURCE WILL RESULT IN A DIRECT SHORT AND COULD CAUSE A FIRE. IT IS WISE TO BE SURE THAT THE 12V SOURCE SELECTED IS FUSED. IF NOT, AN INLINE FUSE RATED AT 10 AMPS SHOULD BE INSTALLED.

WARNING! Connecting the choke cap to the ignition coil will result in unacceptable choke operation, poor fuel economy, and possible engine misfiring since the voltage delivered to the spark plugs will be severely reduced by the drain imposed by the choke. Suitable ignition activated 12V sources are most electrical relays as well as the leads to accessories, such as the windshield wipers. Check voltage source with a volt-ohm meter to assure proper voltage and choke operation.

STARTING:

1. Without operating the throttle, crank the engine. It may take 15 to 30 seconds of cranking to allow the fuel bowls of the carburetor to fill. If the engine does not start, stop cranking, open and close the throttle twice and crank again until the engine starts.

WARNING! DO NOT crank the engine for more than 15 seconds at a time. Cranking longer than 15 seconds can overheat the starter, resulting in premature starter failure.

2. After starting the engine check fuel lines and inlet fittings for possible fuel leaks.

WARNING! If any fuel leakage or weeping is detected, shut off the engine immediately, and wipe up any fuel. Locate the source of the leak and correct before proceeding any further.

3. Check to assure all existing vacuum hoses are attached properly. Plug any fittings not used.

TUNING AND ADJUSTMENT:

Before you begin to tune your carburetor for your particular vehicle, you must get a "FEEL" for your vehicles performance so that any changes you make (Good or Bad) will be readily apparent. Be patient and make only one change at a time so that only that change can be fully analyzed. This cannot be overemphasized, as there are no "short-cuts" to peak performance. Recording each change and the resulting performance increase or decrease will provide you with a "Handbook" of how vehicle performance is affected by individual carburetor adjustments. This may be helpful in the future or on other applications.

FUEL LEVEL (Float Level):

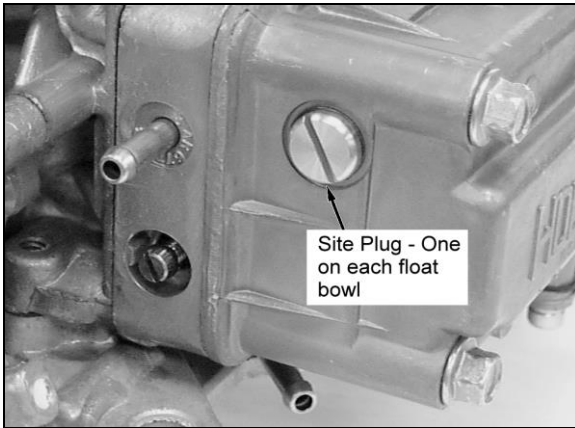

Figure 6

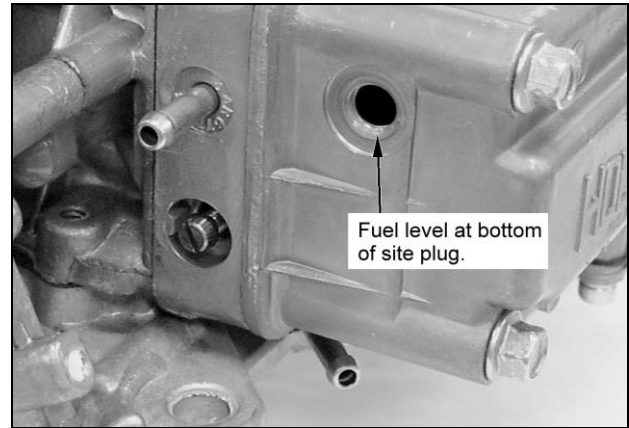

Figure 7

The float(s) controls the fuel delivery, however if the float(s) are not properly adjusted a fuel starvation or a flooding affect could result. This operation is difficult to do accurately on a rough-idling vehicle.

1. Mechanical fuel pump, remove coil wire and crank engine over for 10 seconds to allow fuel bowls to fill. This procedure can prevent a power valve blow out. Reconnect coil wire when finished. Electric fuel pumps, let the fuel bowls fill in stages by turning the ignition on and then off, let fuel pump run for a few seconds at a time. This procedure can prevent the needle from being forced up at an angle not allowing the needle to seat properly.
2. Remove the sight plug from the fuel bowl and start the vehicle.
3. Loosen the lock screw at the top of the assembly.
4. Turn the adjusting nut while holding the screw in place until the fuel level is at the bottom of the sight plug hole even with the threads. A slight trickle can be seen at the threads. Turn the adjusting nut clockwise to lower the fuel level and counter-clockwise to raise the fuel level.

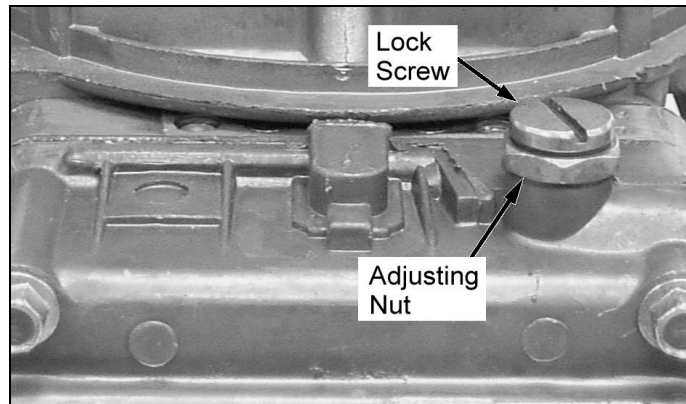

Figure 8

5. Tighten the lock screw while holding the adjustment nut.
6. Replace the sight plug and finger tighten.
7. Flush the fuel bowl by revving the engine a few times with the transmission in the neutral.
8. Remove the sight plug to confirm your setting. A slight trickle should be seen at the threads. Adjust, if necessary.
9. Replace the sight plug and tighten.

IDLE SPEED SCREW:

The idle speed screw in most cases is the only screw you should adjust. The Idle screw controls the throttle plate position at idle which in turn raises or lowers the engine rpm by allowing more or less air/fuel mixture into the engine, it does not control the air/fuel mixture. Here are the proper steps for setting the engines idle speed.

1. Find the proper idle rpm on the underhood decal of your vehicle. If this decal is not available, find a service manual that references your vehicle and engine and find the recommended idle rpm.
2. Start the engine and allow it to warm up.
3. Connect a tachometer, if your vehicle is not so equipped.
4. Make sure the parking brake is on and the wheels are blocked. Place the automatic transmission in drive or the manual transmission in neutral.
5. If the idle speed is slower than recommended, turn the screw clockwise to speed up the rpm. If the idle speed is too fast, turn the idle screw counter-clockwise to slow down. This adjustment should be made to both the primary and secondary screws in equal amounts, so that the throttle plates are opened the same amount. See Figures 9 and 10.

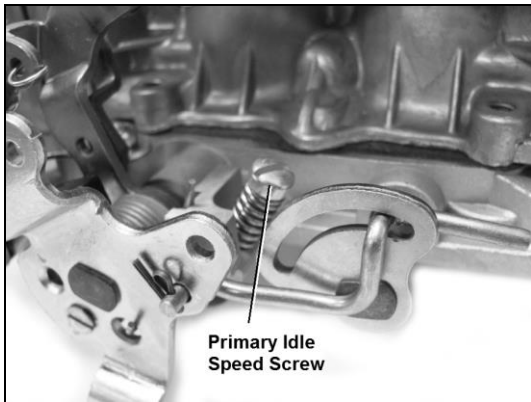

Figure 9

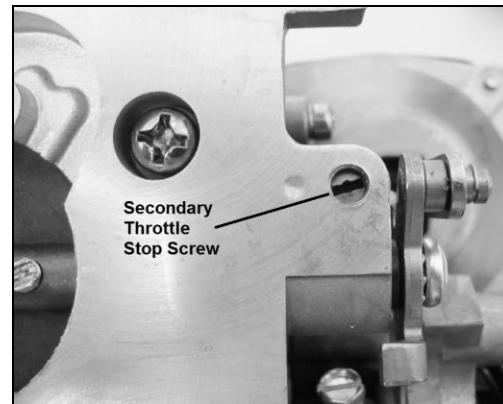

Figure 10

IDLE MIXTURE NEEDLES:

Idle mixture needles control the air/fuel mixture at idle. The amount of air fuel mixture used at idle is controlled by engine vacuum. So when tuning the idle mixture, you are actually tuning for best manifold vacuum. Idle mixture needles are found on the metering blocks. Your carburetor will have four idle mixture needles, one for each venturi, this is known as four corner idle. If you change one idle mixture needle, you are required to change the other idle mixture needles the same amount. Here are the proper steps for setting the idle mixture needles.

1. Attach the vacuum gauge to the manifold vacuum port usually at the rear of the carburetor and on the throttle body.
2. Adjust each idle mixture screw the same amount to achieve the highest possible vacuum reading without increasing the idle speed screw.
3. Now that the idle mixture is set, it may be necessary to go back and reset the idle speed screw. Continue back and forth between the tuning of the idle mixture needles and idle speed screws until little change is noticed in manifold vacuum and idle speed is correct.

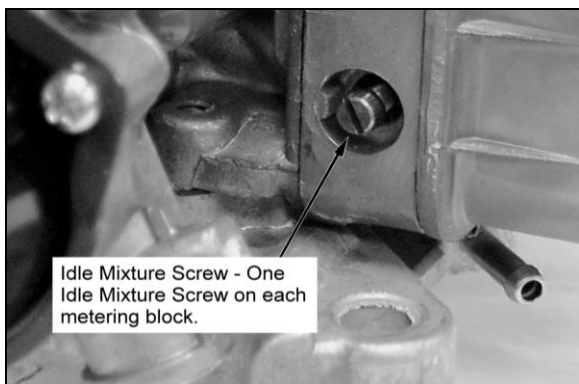

Figure 11

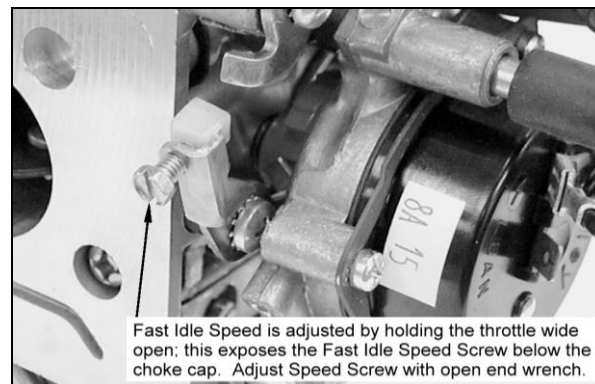

Figure 12

FAST IDLE SCREW:

The fast idle screw works in conjunction with the choke by setting the idle speed while warming up. If your engine idles fine when its warm, but too fast or too slow when cold, then this screw will need adjustment. Use the engine service manual for your vehicle to set the rpm. Here are the proper steps for setting the fast idle.

1. Check the choke tension. The choke must not stick and should work smoothly. If it doesn't, it will cause high idle speeds.
2. With the engine warmed up and the air cleaner off, turn off the engine.
3. Holding the choke butterfly closed with one hand, partially open the throttle and let it close.
4. Release the choke butterfly. This will position the choke fast idle cam in the cold start position.
5. Start the engine without moving the accelerator pedal or throttle.
6. The engine should start and idle at approximately 2000 rpm. If not, the fast idle screw should be adjusted until it does.
7. Move the throttle, the choke should open and the engine should return to normal idle.

ACCELERATOR PUMP:

The accelerator pump's purpose is to make up for the lag in fuel delivery to enable the engine speed to increase in response to throttle opening. Differences in vehicle weight, transmissions, and rear axle ratios affect the amount of fuel and the delivery rate that should be provided by the accelerator pump. This may necessitate the customizing of your accelerator pump to your vehicle and its use.

NOTE: The old saying "if a little is good, a lot is better" does not apply to the proper tuning of the accelerator pump. Your car's performance can be just as bad if it receives "too much fuel too soon" as if it receives "too little fuel too late."

Two factors that affect the accelerator pump's delivery is the **pump cam** and the **pump shooter** (discharge nozzle). The pump cam determines the total volume of fuel and affects delivery rate; the pump shooter affects delivery rate and helps determine the duration of the shot.

In general, the #1 locations on the pump cams provide a moderate initial delivery and have a greater final delivered volume. The #2 locations on the pump cams provide a greater initial delivery and have a lesser total delivered volume. The pump shooters have a number stamped on their casting which designates the shooter size in thousandths of an inch, i.e., a #25 shooter has a .025" discharge orifice. The smaller diameter nozzles lengthen the pump shot duration and are used with heavier vehicles or with vehicles equipped with lower numerical rear axle ratios. Larger diameter nozzles (.035 - .037) shorten the pump shot duration, but deliver a greater initial volume of fuel. These sizes should be used on applications where engine speed will increase rapidly (vehicles with good power-to-weight ratios). Best acceleration is achieved when the accelerator pump delivers the lean best power air/fuel ratio to the engine; not when the maximum volume of fuel is supplied.

An important point should be kept in mind when tuning a Double Pumper, the secondary accelerator pump must supply fuel for a sufficient time so that the secondary main nozzles can "start up" and deliver fuel to the engine after the secondary throttles are opened. If the nozzles do not start by the time the pump shot expires, bogging will result. To apply the information above, follow these steps for tuning the accelerator pump.

Best starts or racing starts usually result when the rear tires break loose for the first 10 to 25 feet, this allows engine speed to increase rapidly to get the secondary main nozzles started. If wide tires, which provide extremely good traction, do not permit the rear tires to break loose, bogging can result. Best times may be recorded with narrower tires. This attention to tire size is not so important on vacuum operated secondary carburetors since the secondary throttles will not open until the secondary nozzles are exposed to enough vacuum to get them started.

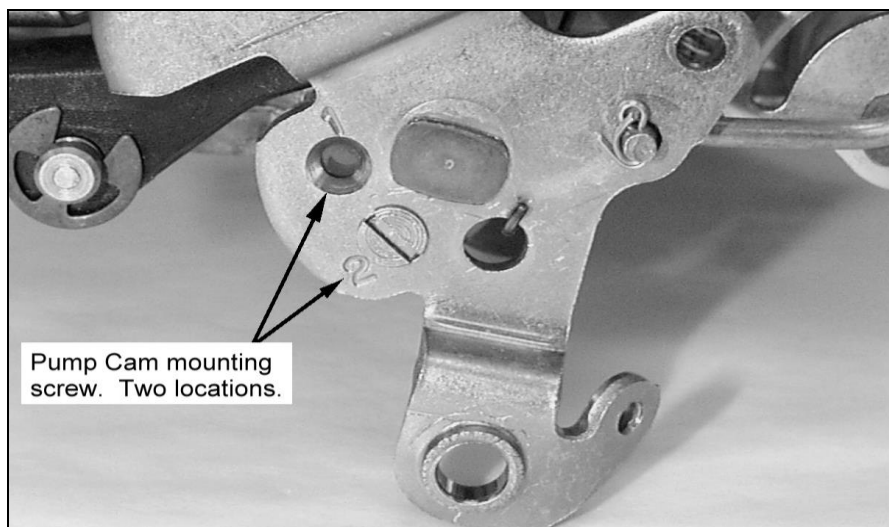

Figure 13

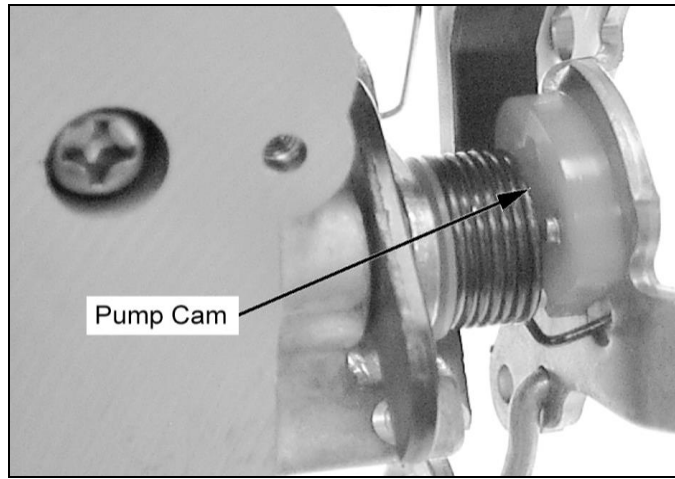

Figure 14

1. Change pump shooters until the smallest diameter nozzle, which provided the crispest response is found.
2. Then change the pump cams and locations until the right cam is found that provides even more response.
3. Finally, change the pump shooter once again until the crisp response is maximized.

NOTE: If a nozzle size is desired that seems “in between” the nozzle sizes provided, then the nozzle can be drilled to the desired size by using a wire drill held in a pin vise.

4. At this point, there should be no bogs, flat spots or black smoke (indicating excessive richness) when accelerating at wide open throttle from a standing start.

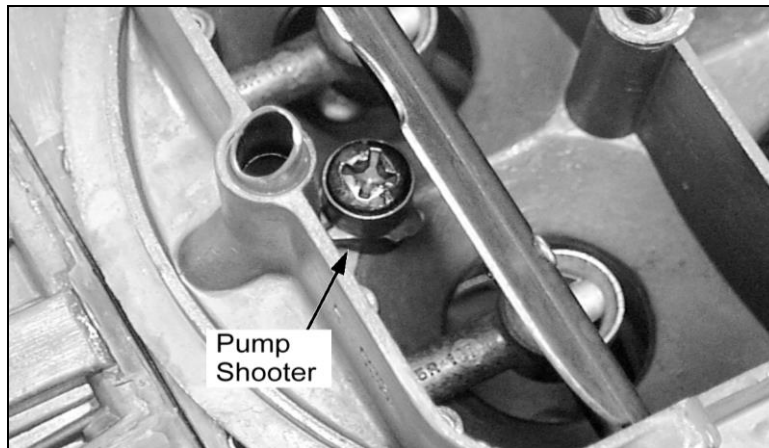

Figure 15

VACUUM OPERATED SECONDARY THROTTLES:

Many people have the misconception that opening the secondary throttles sooner will provide increased performance and quicker drag strip times. Others think they must "feel" a kick when the secondaries engage. Still others believe that they should disconnect the vacuum diaphragm and make the secondaries open mechanically.

Before going any further, let's discuss these points in a reverse order. First, if we could make our vacuum operated secondary carburetors perform better by opening the secondaries mechanically, it would be to our advantage to do so since all that vacuum actuating hardware is expensive and requires much time and money to calibrate. Mechanical secondary carburetors all utilize a pump shot to prevent bogging when the secondaries are opened. Secondly, those who "feel" a kick when the secondaries engage are actually feeling a flat spot during initial acceleration because the secondaries have already begun to open and have weakened the fuel delivery signal to the primary boosters. The engine is struggling to increase speed and what they actually feel are the secondary nozzles "crashing in" as the engine finally reaches the speed where it provides the proper fuel delivery signal to primary and secondary venturii. Third, opening the secondaries early causes the situation described above. The secondaries must not open until the engine requires the additional air, this allows torque to increase along the peak torque curve. Performance is compromised less by holding the secondaries closed a little longer than by opening them a little too soon. If the opening rate of the vacuum operated secondaries is properly calibrated there should not be a "kick", only a smooth increase in power should be felt.

In general, heavier cars require stiffer secondary diaphragm springs than light cars. Air cleaner configuration and restriction plays an important part in spring selection also, so be sure to use your air cleaner when evaluating your vehicles performance after each change. **DO NOT** expect to "wing" the throttle and see the secondaries begin to open. If they do they will probably open too soon. Secondaries should open only when the engine is under a load. **DO NOT** clip a spring in an effort to make a spring lighter so that the secondaries will open sooner. Strange as it may seem, clipping springs actually increases spring rate and will delay opening. So in order to tune the secondaries follow the steps below. The secondary springs are available from your local Holley retailer.

1. Remove the choke cap and choke housing (if carburetor is equipped with integral choke).
2. Remove three screws attaching secondary vacuum diaphragm to the main body.
3. Remove the four screws securing diaphragm cover.
4. Gently remove the cover and change the spring. The stiffer the spring, the later the secondaries will open.
5. When reassembling secondary diaphragm parts, exercise care to properly align the vacuum passage in the casting with the "cut out" in the rubber diaphragm. **DO NOT** pinch or tear the rubber diaphragm.
6. Make sure the cork gasket in the secondary diaphragm housing mates with the main body casting and reassemble.

JETTING (MAIN JETS):

Due to varied applications that a universal performance carburetor will work with, no additional tuning jets have been included. However, a few tips on jetting are provided to help you understand their purpose. Holley's Quick Change Fuel Bowls (P/N 34-24) are recommended if repeated changes or experimentation with the main jets will be performed.

1. Out of the box jetting is extremely close for most applications.
2. In most cases it will be unnecessary to increase jet size more than four numbers greater than out of the box jetting. However, exceptions could arise when the carburetor is mounted on a very large volume, plenum-ram manifold.
3. Carburetors are calibrated at 70° at sea level. Decrease the jet size one number (approx. .002) for approximately every 2000 ft. increase in altitude. Increase jet size one number for every 35° drop in temperature.
4. Holley jets are broached, flowed and stamped according to flow rate. **Never drill jets**, this seriously alters flow characteristics. Stamped numbers are reference flow numbers and **DO NOT** indicate drill size.
5. Spark plugs provide the best indication of proper jetting. Allow plugs to cool before jumping to conclusions.
6. When used with high velocity emission manifolds, some older calibrations actually show power increases when jet size is lowered a couple of number sizes below stock jetting.

AIR BLEEDS:

Experimenting with air bleeds is not recommended. Countless hours of testing have been performed on expensive flow stands to obtain the proper bleed size for a given calibration. It is unlikely that a better air bleed calibration can be obtained without extensive experience and facilities; and it is most likely that a useless piece of junk can result from what was previously a high performance carburetor.

POWER VALVES:

The number stamped on a power valve, such as 65, indicates the manifold vacuum below which the power valve is operational. In this case, all manifold vacuums below 6.5" Hg, the power valve is operating. Generally a 65 power valve is sufficient for most high performance applications; however, some problems can result with radically cammed, full-race machines equipped with automatic transmissions. These vehicles often "idle" at 2000 rpm, approx. 6.0" Hg. At this point the main nozzles are starting to feed and enrich the mixture (supplied by the power valve) and the engine will probably "load up". To correct this problem, install a 45 or 35 power valve. This will provide idling and proper fuel flow under wide open throttle conditions when manifold vacuums seldom rise above 1" Hg.

SLOSH TUBES:

Slosh tubes can be used in the secondary jets to prevent the secondary main jets from being uncovered as fuel rushes to the back of the fuel bowl during extreme accelerations.

FUEL BOWL VENTS:

The white plastic "whistle" vent should be used in the primaries to prevent fuel from spilling out of the primary vent tube during hard accelerations. The vent extends into the fuel bowl from the top of the primary metering block. Drill a .063 starter hole in the drill point in the top center of the metering block. Drive the self-tapping nail through the hole into the vent whistle. Make sure the vent does not bend under the drive nail. The brass vent should be used on the secondary side and mounted on the two top center locating pins on the fuel bowl face of the metering block between the fuel bowl gasket and the metering block.

GENERAL INFORMATION:

This instruction sheet cannot contain all of the information, which may be desired by some individuals. Further clarification is available in **HOLLEY CARBURETORS**, published by H.P. Books.

1. An in-line fuel filter should be installed between the fuel pump and the carburetor.
2. Recommended fuel pressure should be set at 7-1/2 psi maximum, 5 psi minimum. Fuel pressures above 7-1/2 psi can create severe fuel control problems and are not recommended.
3. Fuel lines should be a minimum of 3/8".

**Holley Technical Support
1801 Russellville Road
Bowling Green, KY 42101
Phone: 1-270-781-9741 or 1-866-464-6553
Fax: 1-270-781-9772**

For online help, please refer to the Tech Service section of our website: www.holley.com

© 2003 Holley Performance Products, Inc. All rights reserved.

199R8108-2

Revision Date: 4-8-14