



43007FLT FLOWTECH I® STANDARD HEADERS
63007FLT FLOWTECH II® CERAMIC HEADERS

1975-1987 Chevy/GMC Pickup ½, ¾, & 1 ton 4WD only
1975-1991 Chevy Blazer/GMC Jimmy 4WD (full size)
1975-1991 Chevy/GMC Suburban 4WD
(283-400 V-8 Engines)

We realize that you had many choices when you chose your headers, and we thank you for choosing ours. At FLOWTECH® we put many years of performance exhaust experience into every product we build. We feel and know you will agree that FLOWTECH® Headers are the best you can buy at any price.

As a result of the restricted room available in some engine compartments, you may experience a close fit to some body and chassis components. This is a normal condition. If this is your first time installing a set of headers, it may be time consuming. While not complex, stick with it. As soon as you start your engine, the reward of additional horsepower and performance will be well worth your efforts. Proper installation and periodic maintenance will result in maximum performance and life from your FLOWTECH® Headers.

READ THESE INSTRUCTIONS CAREFULLY BEFORE STARTING:

For ease of installation, your vehicle must be raised a minimum of 24". **Warning:** should you decide to install any exhaust product yourself, be warned that the original equipment jack that came with the vehicle is intended for emergency use only. The use of a frame jack in conjunction with a floor jack as the main support is highly recommended to minimize the accidental dropping of a vehicle while the installation proceeds. Never go under any vehicle that is supported by a bumper jack!

PREPARE THE VEHICLE FOR INSTALLATION:

1. Disconnect the battery to prevent accidental damage to the electrical system. Remove the starter.
2. Remove the alternator, clutch linkage, oil dipstick tube and spark plugs. On air conditioning equipped vehicles, unbolt the compressor and lay it aside. On late model vehicles remove the power steering bracket.
3. Remove the stock exhaust manifolds and the stock headpipe.
4. Disconnect the water temperature sending unit.

CHECK THE CONDITION OF THE ENGINE MOUNTS

NOTE: It is recommended that new engine mounts be installed before installing headers.

LEFT SIDE HEADER INSTALLATION:

1. Starting from below, work the header up through the chassis into position.
2. Place the gasket into position and start all mounting bolts (most restricted first).
3. Replace the spark plugs, alternator, clutch linkage, oil filter, and dipstick tube.

NOTE: Early model engines will require converting the canister oil filter to a screw-in oil filter.

NOTE: To install the alternator it may be necessary to use FLOWTECH® adapter brackets #10031FLT and/or #10033FLT. See **Figure A**.

NOTE: Air conditioned vehicles may require the purchase of FLOWTECH® adapter bracket #10042FLT or the factory bracket can be cut, as shown in **Figure B**.

NOTE: Refer to **Figure C** for typical power steering bracket installation.

RIGHT SIDE HEADER INSTALLATION:

1. Starting from below, work the header up through the chassis into position. Some years may require raising the engine slightly. Be sure to place a board between the jack and the oil pan.
2. Place the gasket into position and start all mounting bolts, with the most restricted ones first.

NOTE: If the A/C bracket is mounted on a cast iron bracket supported by two exhaust manifold bolts, cut or grind the bracket to clear the #1 header tube. (See **Figure D**). It will be necessary to purchase some spacer material at a hardware store, 7/16" I.D. x 3/4" O.D.. Cut the spacers to length, one 1¼" long and one 2" long.

NOTE: Replace the starter and connect the wires. Reroute as necessary for maximum header clearance.

3. Install the balance of the bolts. Tighten all header bolts progressively and evenly until they are tight.

AFTER HEADERS ARE IN PLACE:

1. Inspect all points with limited clearance. Relocate any points that have direct contact with the headers. Make sure there is adequate clearance around all lines (transmission, brake, fuel, and electrical wires). Reroute as necessary. Before installing your exhaust system, replace any fluids that you may have removed or lost.
2. Reinstall the oil dipstick tube, spark plugs and wires, temperature sending unit, air conditioning compressor, and alternator.
3. Reconnect the battery cable.

CONNECT THE EXHAUST SYSTEM:

1. Bolt the reducers and gaskets to the header collectors.
2. Attach the exhaust system by either welding or clamping the exhaust pipes to the reducer adapters.

When you have finished installing your headers, take the vehicle for a road test. Listen carefully for any exhaust leaks or other strange noises and make corrections. When the vehicle has been driven for a few days, retighten the header bolts. We find that periodically checking the bolts will prevent the flange from warping and the burning out of the header gaskets.

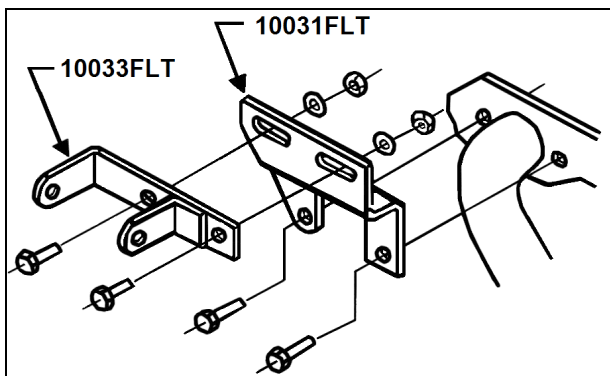

Figure A

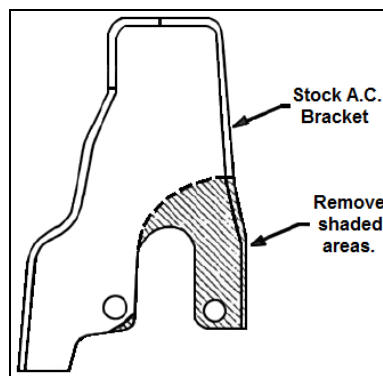

Figure B

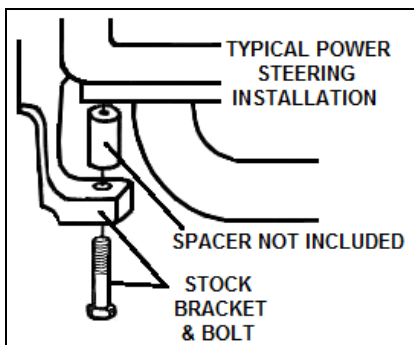

Figure C

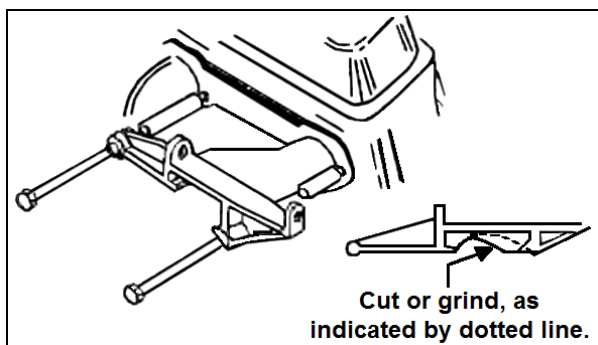

Figure D

Flowtech Technical Support
Toll-Free Phone: 1-866-464-6553
For online help, please refer to the website: www.holley.com