



Installation Instructions
718142
2022-23 TOYOTA TUNDRA
WITH 3.5L ENGINE

2- or 4-WHEEL DRIVE

145.7 IN., 157.7 IN., and 164.6 IN. WHEELBASE

See "Applications" tab on the product web page for specific applications.

ITEM	PART NO.	DESCRIPTION	QTY.
1	86737M	RIGHT INLET PIPE	1
2	86736M	LEFT INLET PIPE	1
3	72468-598	FLOWFX MUFFLER	1
4	86741M	RIGHT OVER-AXLE PIPE	1
5	86740M	LEFT OVER-AXLE PIPE	1
6	86743M	RIGHT TAIL PIPE ASSY	1
7	86742M	LEFT TAIL PIPE ASSY	1
8	TB932M	EXTENSION PIPE	2
9	86744M	SIDE EXIT PIPE	2
10	ST507B	TIP, BLACK CERAMIC	2
11	MC250BS	CLAMP, STAINLESS, 2-1/2"	10
12	HA572	BRACKET, UNIVERSAL	1
13	HW204	BOLT, 5/16-18 x 1"	1
14	HW102	NUT, 5/16-18	1
15	HW302	FLAT WASHER, 5/16"	2
16	HW308	LOCK WASHER, 5/16"	1

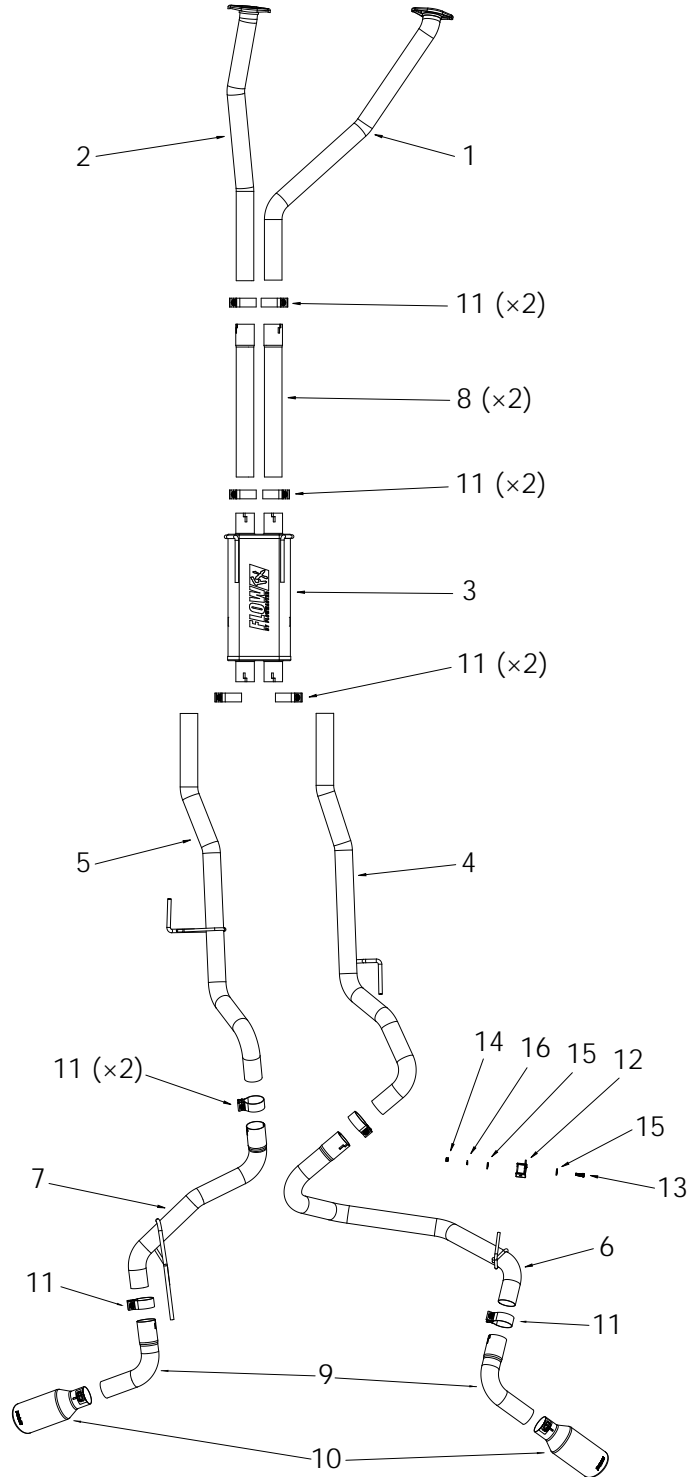

NOTES

- Installation requires moderate mechanical skill. If this job is beyond your abilities, seek the services of a qualified technician.
- If you do not understand any part of these instructions, please call Flowmaster Technical Support at (866) 464-6553 for assistance.
- Use stands to support exhaust system components, both when removing the stock system, and when installing your new kit.
- Apply penetrating oil generously to clamps, fasteners, pipes, and hanger rods for ease of disassembly.

REVIEW THE INSTRUCTIONS & VERIFY THE KIT CONTENTS

Take a moment to read and understand these instructions before installing your Flowmaster FlowFX exhaust kit.



Use the parts drawing and list to verify your kit's contents. In the unlikely event that any parts are missing, please contact Flowmaster Technical Support for replacements.

REMOVE THE FACTORY EXHAUST SYSTEM

WARNINGS

- **AVOID BURNS!** Exhaust systems get extremely hot. Allow the vehicle to cool down fully before starting work.
- **AVOID SERIOUS INJURY OR DEATH BY CRUSHING!** Never work under a vehicle that is supported by jacks.

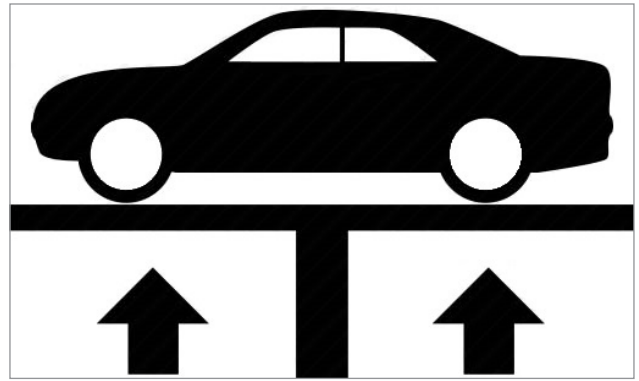

1. **Raise the vehicle** to working height on a lift. If you do not have a lift, securely support the vehicle on jack stands.

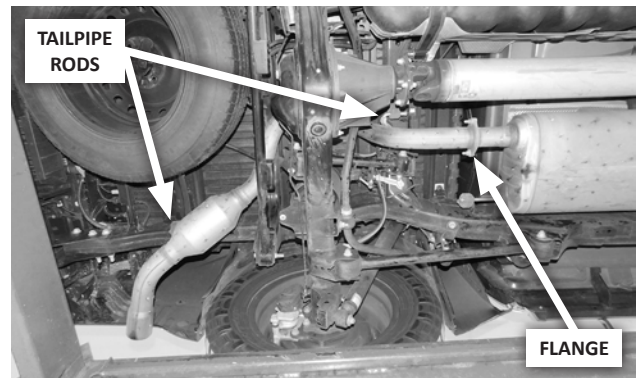

2. **Remove 2 nuts at the tailpipe flange.** Disengage tailpipe rods from rubber isolators (2 places).



3. **Lower the spare tire for clearance,** and remove the tailpipe from the vehicle.

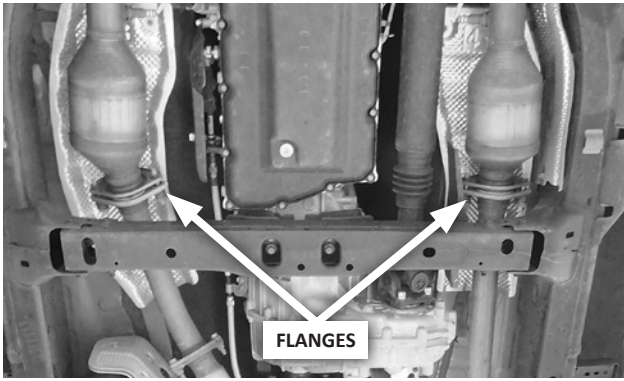

- Remove and retain 4 screws and springs at the 2 catalytic converter flanges.



- Disengage muffler rods from rubber isolators (3 places), and remove muffler and pipe assembly from vehicle. Remove and retain 2 flange gaskets. Retract the spare tire to its stowed position.

INSTALL YOUR FLOWMASTER EXHAUST SYSTEM



- Before installing clamps in the following steps, remove their nuts, apply anti-seize compound to the bolt threads, and re-install the nuts.

NOTE: All pipe-to-pipe slip-fit connections must seat 3" deep. All pipe-to-muffler connections must seat 2" deep. Mark the male ends of each pipe in advance, to ensure proper insertion during assembly.



- Attach left (2) and right (1) inlet pipes to factory exhaust with the 2 stock gaskets, and 4 screws and springs, ensuring that both pipes are oriented properly.

CAB	BED	WHEELBASE	EXTENSION PIPES
Double	8.1 ft	164.6 in	Use as received
CrewMax	6.5 ft	157.7 in	Cut back 6-7/8"
Double	6.5 ft	145.7 in	Not used
CrewMax	5.5 ft		

- Determine if your truck requires the two extension pipes (8). If not, skip to Step 11.

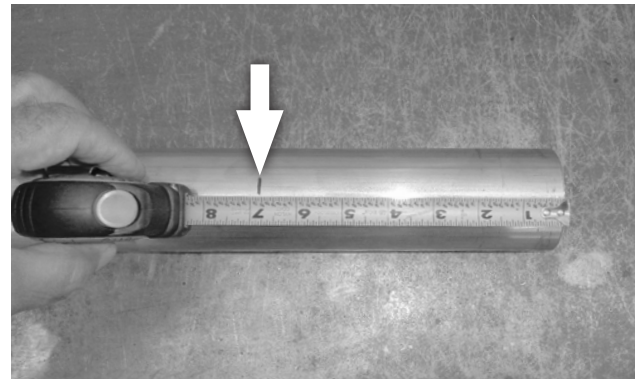

- If applicable, cut 6-7/8" off the muffler-end of the extension pipes.
- If applicable, slip a clamp (11) over each extension pipe, and install them on the inlet pipes. Verify 3" of insertion, and snug the clamps slightly (just enough to allow final adjustment later).



11. Slip two clamps (11) over the muffler's (3) inlets (the end with the hanger rods). Install the hanger rods in the rubber isolators, then install the muffler on the inlet pipes. Verify 2" of insertion, and snug the clamps slightly.

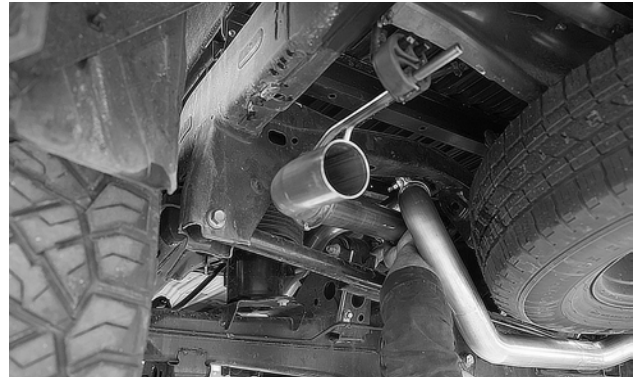

14. Slip a clamp (11) over the left tail pipe (7). Install its hanger rod in the rubber isolator, then slip it over the over-axle pipe. Verify 3" of insertion, and snug the clamp slightly.

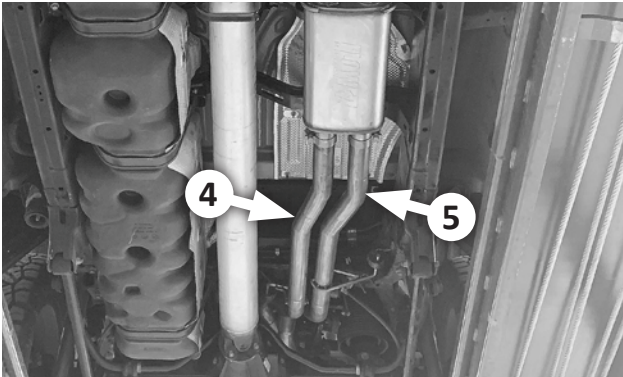

12. Slip a clamp (11) over the muffler's left outlet. Move the left over-axle pipe (5) into place, and insert its hanger rod into the rubber isolator. Insert the pipe into the muffler, verify 2" of insertion, and snug the clamp slightly. Repeat the process for the right over-axle pipe (4).



15. Slip a clamp (11) over each side exit pipe (9), and install each exit pipe on its tail pipe. Align each exit pipe as desired, verify 3" of insertion, and snug each clamp slightly.

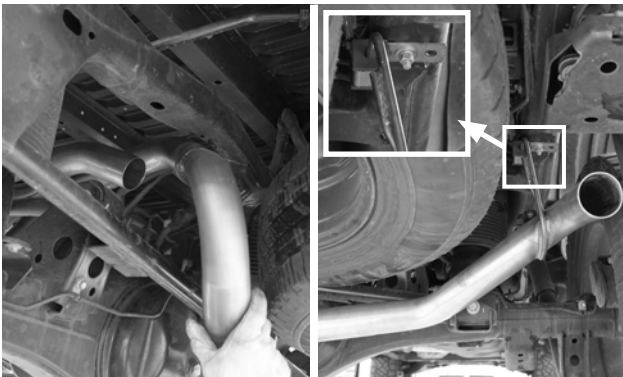

13. Slip a clamp (11) over the right over-axle pipe. Install the universal bracket (12) on the right tail pipe's (6) hanger rod, with the flat pointing outboard and facing up toward the frame. Slip the tail pipe over the over-axle pipe. Then fasten the bracket to the frame with the bolt (13) and a flat washer (15) against the frame, and the other flat washer (15), the lock washer (16), and the nut (14) against the bracket. Verify 3" of insertion, and snug the clamp slightly.



16. Install a tip (10) on each exit pipe. Align each tip as desired, and tighten its clamp.

17. Adjust all components to give 1/2" to 3/4" clearance (about a finger's width) around them, and allowing for suspension travel and vibration. When you are satisfied with the system's clearance and fit, tighten all clamps.

18. Recommended: Tack weld (approx. 1") the slip-fit connections for added security, then paint each weld with a coat of high-temp spray paint to protect against corrosion.

Congratulations, the installation of your Flowmaster FlowFX performance exhaust system is complete!

KEEP THESE INSTRUCTIONS FOR FUTURE REFERENCE

Flowmaster maintains a highly-trained technical service department to answer your technical questions, provide additional product information and offer various recommendations.



FLOWMASTER TECHNICAL SUPPORT: (866) 464-6553