



3651 N Highway 89 • Chino Valley, AZ 86323
(928) 636-7080

FORD F-150 2WD / 4WD
3" BODY LIFT KIT
(V8 ENGINES w/OEM Hitch *ONLY*)
INSTALLATION INSTRUCTIONS
2009-2014 KIT #70093

⚠ WARNING

Installation of a Performance Automotive Group body lift kit will change the vehicle's center of gravity and handling characteristics both on- and off-road. You must drive the vehicle safely! Extreme care must be taken to prevent vehicle rollover or loss of control, which could result in serious injury or death. Avoid sudden sharp turns or abrupt maneuvers and always make sure all vehicle occupants have their seat belts fastened.

⚠ WARNING

Before you install this kit, read and understand all instructions, warnings, cautions, and notes in this instruction sheet and in the vehicle owner's manual.

⚠ CAUTION

Proper installation of this kit requires knowledge of the factory recommended procedures for removal and installation of original equipment components. We recommend that the factory shop manual and any special tools needed to service your vehicle be on hand during the installation. Installation of this kit without proper knowledge of the factory recommended procedures may affect the performance of these components and the safety of the vehicle. We strongly recommend that a certified mechanic familiar with the installation of similar components install this kit.

⚠ WARNING

DO NOT combine suspension, body, or other lift devices. Use of vehicle with combined lifts may result in unsafe and/or unexpected handling characteristics.

⚠ WARNING

This kit should only be installed on a vehicle that is in good working condition. Before you install the kit, thoroughly inspect the vehicle for corrosion or deformation of the sheet metal around the factory body mounts. If the vehicle is suspected to have been in a collision or misused, do not install this kit. Off-road use of your vehicle with this kit installed may increase the stress applied to the factory body mounts. We do not recommend that any vehicle with a body lift kit installed be involved in any extreme off-road maneuvers such as jumping. Failure to observe this warning may result in serious personal injury and/or severe damage to your vehicle.

⚠ WARNING

Many states and municipalities have laws restricting bumper heights and vehicle lifts. Consult state and local laws to determine if the changes you intend to make to the vehicle comply with the law.

⚠ WARNING

The installation of larger tires may reduce the effectiveness of the braking system.

⚠ WARNING

Always wear eye protection when operating power tools.

⚠ WARNING

Before you install this kit, block the vehicle tires to prevent the vehicle from rolling.

⚠ WARNING

Accidental deployment of the air bag can result in serious personal injury or death. To avoid accidental deployment during installation of the kit, the Supplemental Restraint System (SRS, or airbag) must remain deactivated. Do not allow anyone near the airbag during installation. Refer to the factory service manual or owner's manual for the recommended procedure to disable the SRS. After you install the kit, reactivate the SRS before driving the vehicle.

NOTE

Performance Automotive Group recommends using the Loctite® supplied in the kit on the threads of all kit nuts and bolts unless specified otherwise in these instructions.

A. Before you start.

NOTE

Kit parts are prefaced by the word *kit* and appear in **bold** print.

1. Read all warnings and instructions completely and carefully before you begin.
2. Check to make sure the kit is complete (refer to the Parts List at the end of this document).

NOTE

If parts are missing from kit, please be prepared to provide the following information:

1. **Name** of purchase location
 2. **Bar Code** on side of box
 3. **Date** above bar code
 4. **Date** inside box cover
 5. **Inspector #** from inside box cover
3. Only install this kit on the vehicle for which it is intended. If anytime during the installation you encounter something different from what is outlined in the instructions, call technical support at (928) 636-7080.
 4. Park the vehicle on a clean, dry, flat, level surface and block the tires so the vehicle cannot roll in either direction.
 5. Special tools needed
 - a. Welder (or access to a professional welding shop)
 - b. Die grinder (or other tool capable of cutting thick metal)
 - c. 1/2" & 9/16" drill bit
 6. Disconnect the negative cable first, then the positive cable from the battery.
 7. Airbag fuse

⚠ NOTE

The location of the fuse panel may vary; check the owner's manual.

- a. Remove the kick panel cover and fuse panel cover on the passenger side.
- b. Remove two airbag fuses (Check your manual) from the fuse panel.

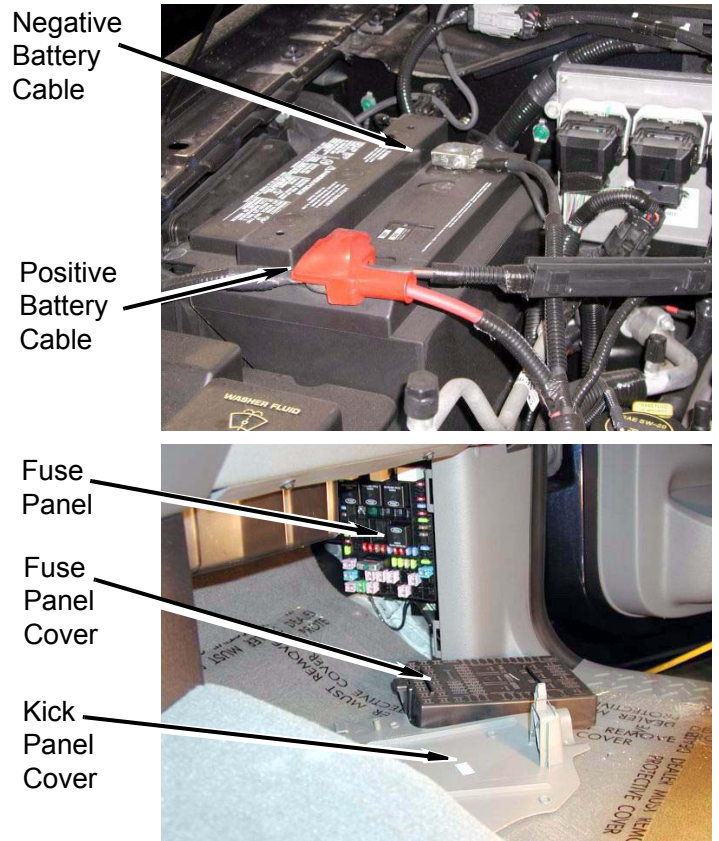

B. Get ready to install the kit

1. Front bumper

- a. Measure and record the distance between the front bumper and the fenders for future reference.

Driver Side _____ Passenger Side _____

- b. **(Vehicles with tow hooks)** Remove four bolts and two tow hooks from the frame ends.

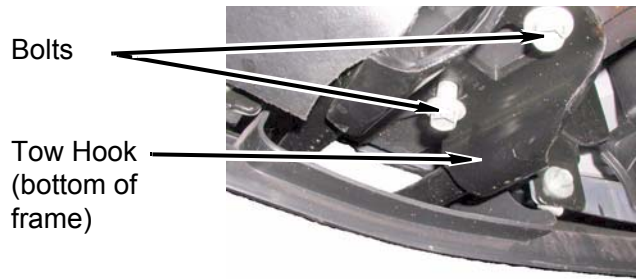

- c. **(Vehicles with fog lamps)** Disconnect the wiring harness connector from each fog lamp.

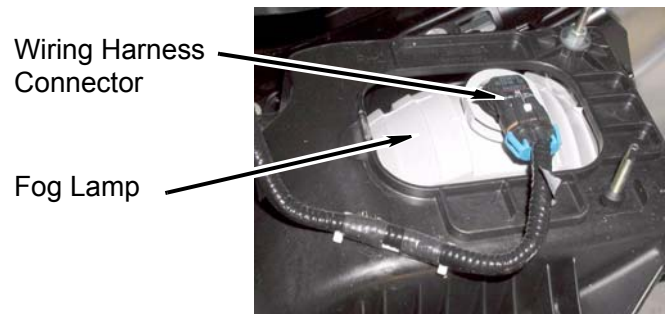

- d. Remove push pins and the air flap from the front bumper and radiator lower support.

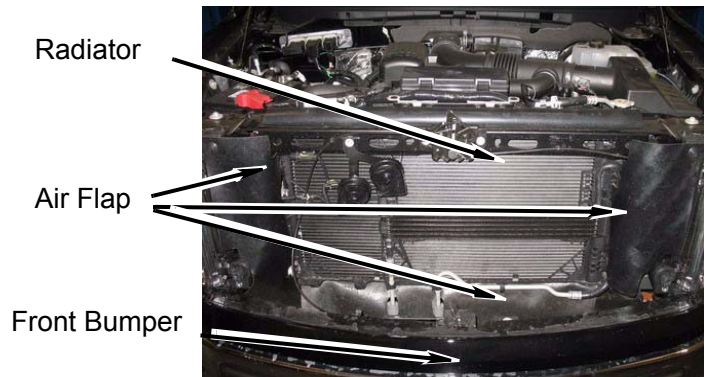

- e. Remove four push pins holding the radiator air flaps to the frame near the A/C condenser (driver and passenger side).

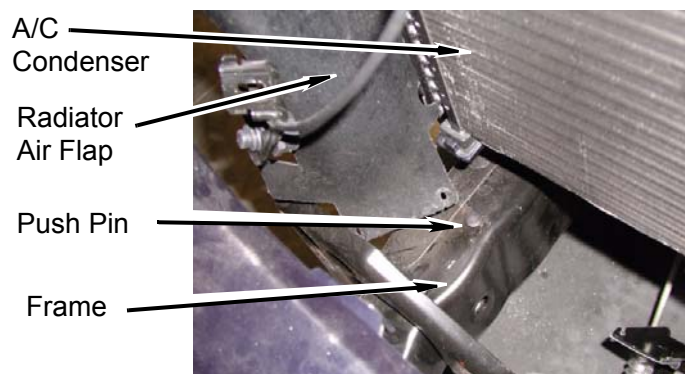

- f. Remove one bolt and the hood release mechanism from the top of the front bumper. Also, remove the two OEM bolts that are attached to the top of the bumper.

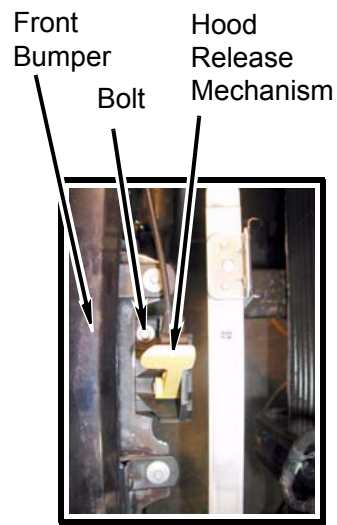

- g. Remove four nuts and the front bumper from the frame flanges.

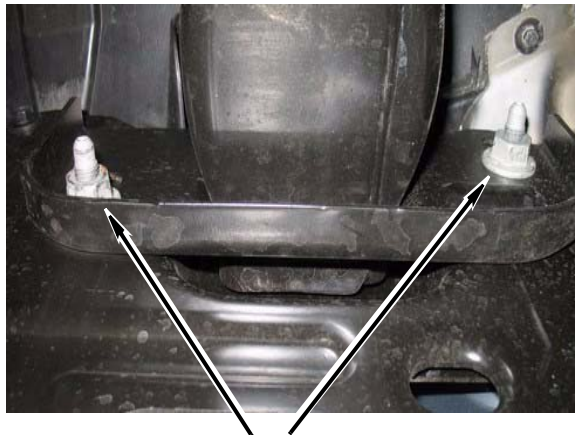

Bumper mounting bolts (captive) on the bumper mounting bracket

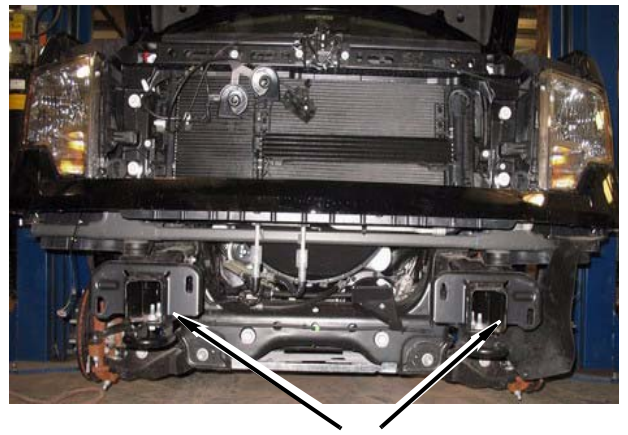

Remove the bumper mounting nuts from behind the frame flange

- h. Remove the automatic transmission cooler hoses from the radiator lower support clips. **(Note: you may also remove the cooler, so no damage occurs to the cooler lines.)**

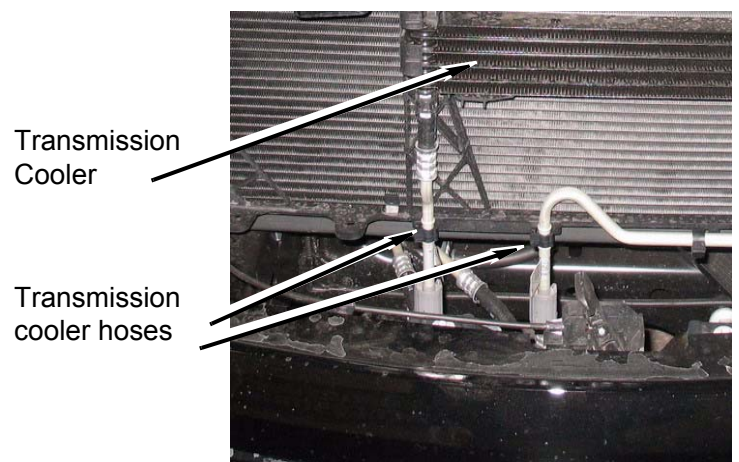

2. Under the hood

- a. Remove the air intake duct.
- b. Remove the air intake duct from the air intake housing and air box on the driver side inner fender.

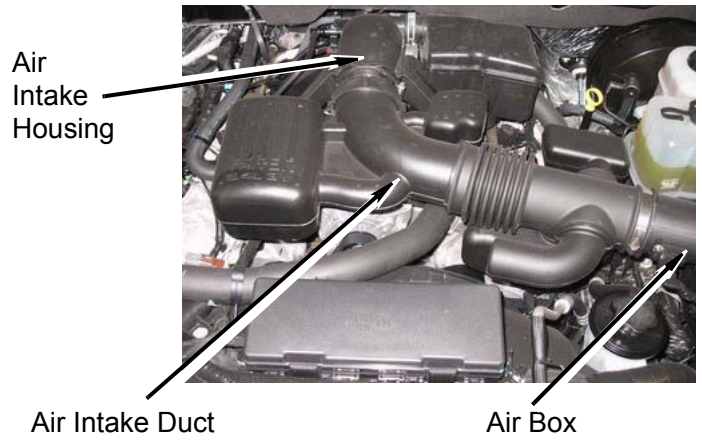

- c. Remove one screw and remove power steering reservoir from fan shroud.

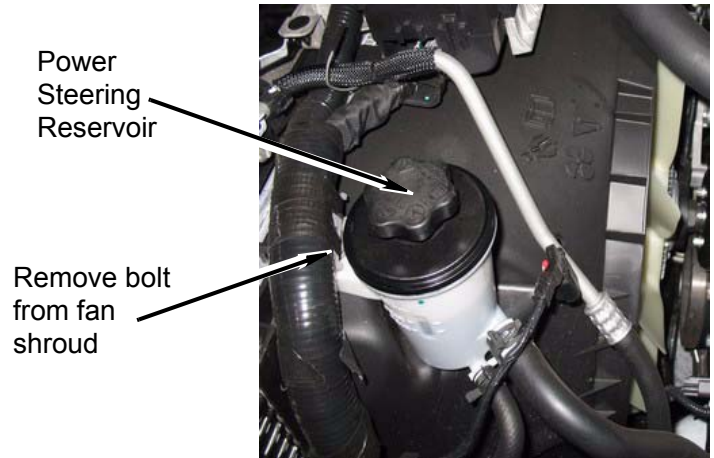

- d. Remove one screw and remove Vacuum regulator from fan shroud.

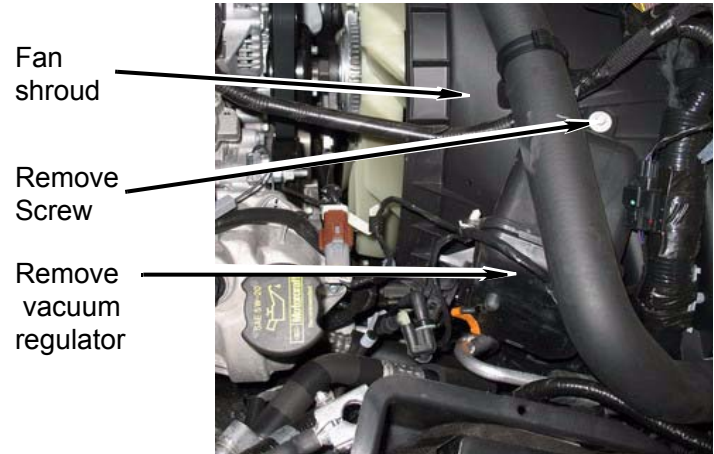

3.

⚠ NOTE
Some vehicle models **do not** have a mechanical fan. Please **skip** the fan shroud steps taken when the truck has a electric fan. The fan shroud will not need drop down brackets on these trucks.

- a. Remove four screws from fuse box, then remove fuse box from radiator core and fan shroud (**Note:** Place fuse box toward engine along with harness. This will allow you enough room to remove upper fan shroud).

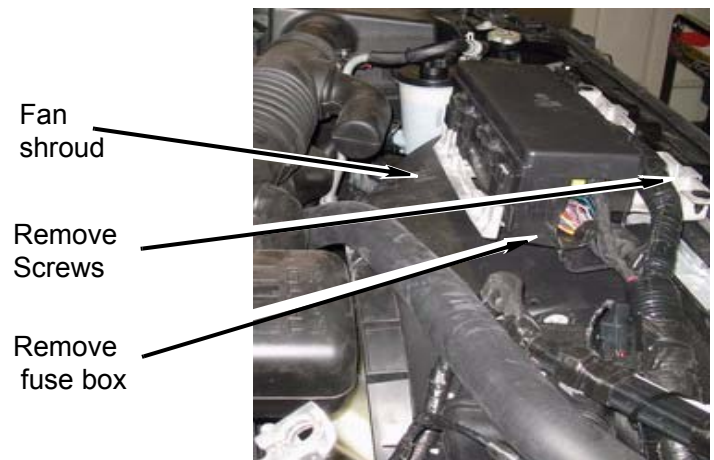

- b. Remove power booster hose from power booster.

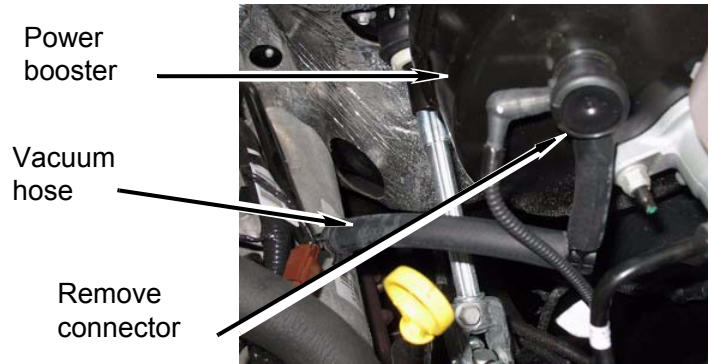

4. Under the hood (fan shroud)

- a. Carefully remove push pins and the shroud from the top of the radiator core and fan shroud.



- b. Remove the wiring harness clip from the passenger side of the fan shroud.

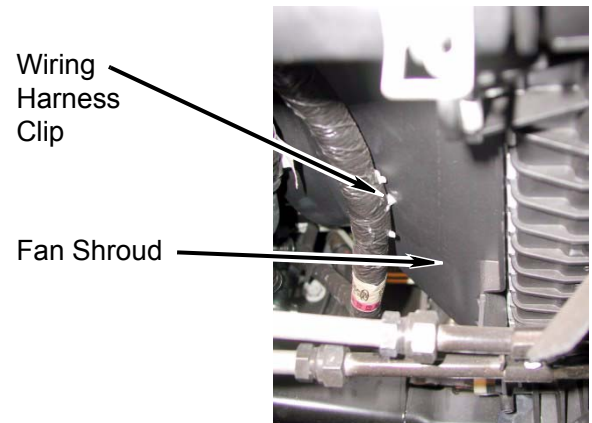

5. Under the hood (miscellaneous)

- a. Disconnect the ABS sensor wiring harness from the push clip at both front fender wells.

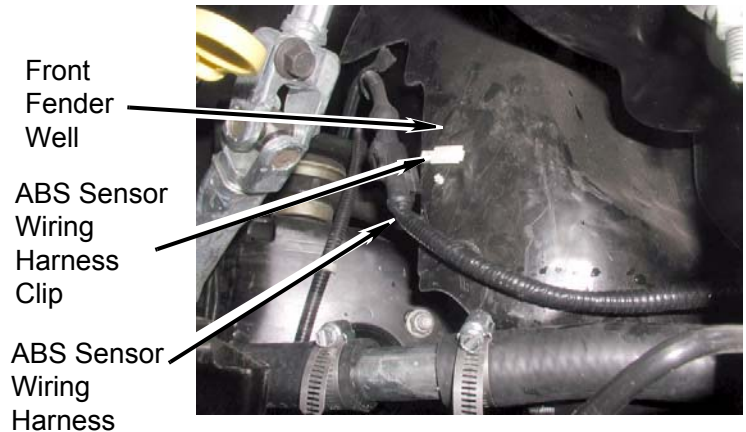

- b. Remove the bolt and the ground strap from the firewall.



⚠ NOTE
 Some vehicle models **do not** have a mechanical fan. Please **skip** the fan shroud steps taken when the truck has a electric fan. The fan shroud will not need drop down brackets on these trucks.

- c. Remove bottom half of fan shroud by removing two push clips from each side. Unclip center section of shroud and rotate shroud up and forward. Push in sides once it is fully rotated forward and remove bottom half of shroud.

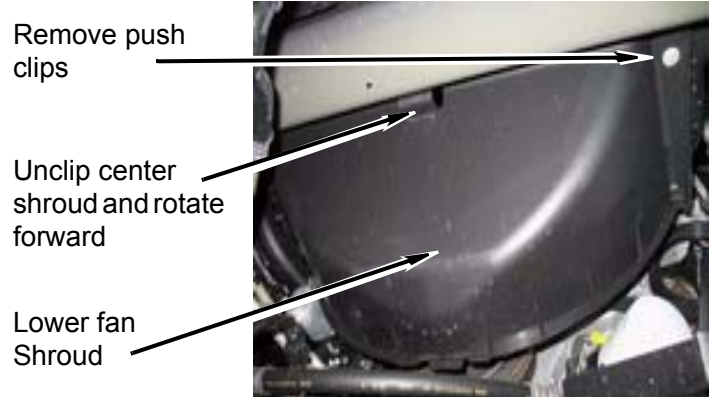

- d. Remove two bolts holding the upper fan shroud to the radiator.

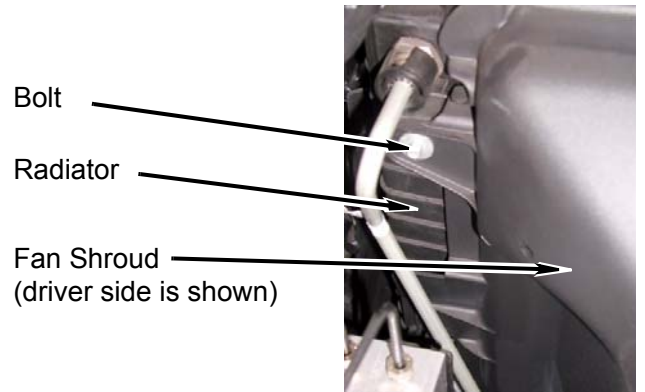

- e. Remove the fan shroud from the radiator retaining clips, then remove the fan shroud from the vehicle.

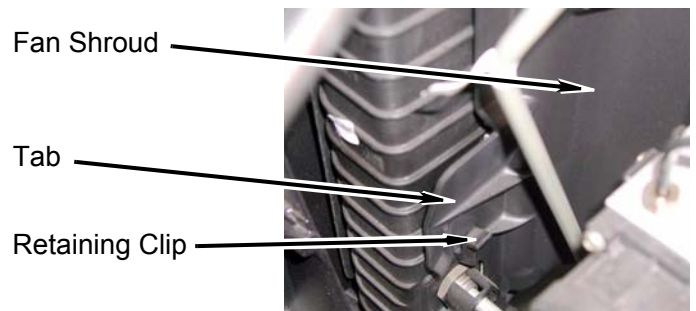

- f. Remove three bolts holding the ABS brake controller side bracket on the frame (driver side).

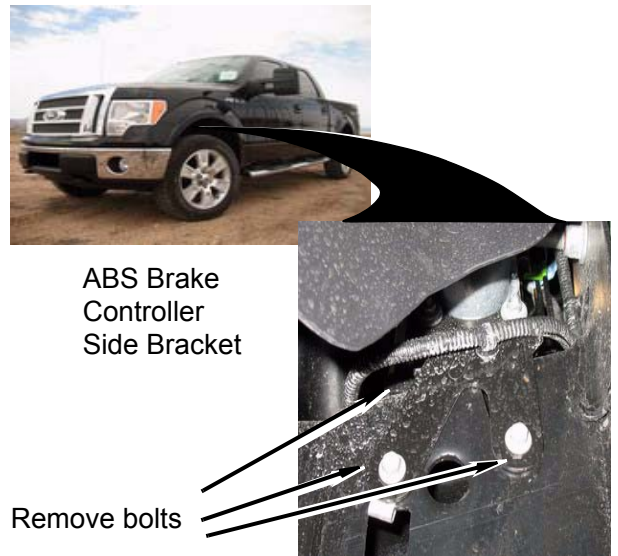

- 6. Along the frame / under the cab
 - a. Remove the brake line from the retainer on the frame (driver side, below the steering shaft U-joint, on the inboard face of the frame).

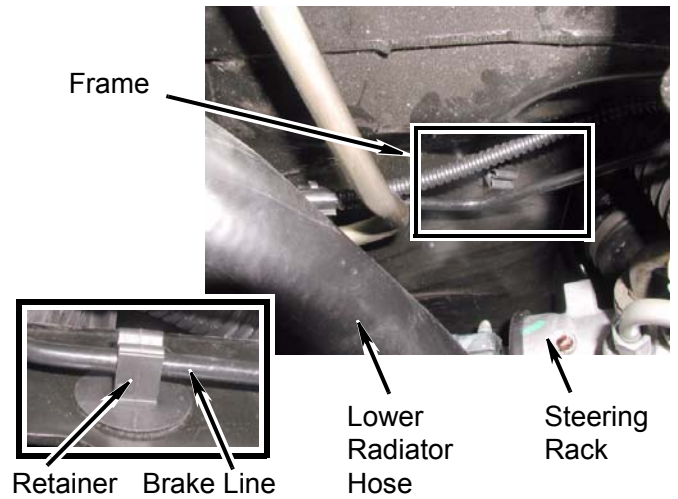

- b. Remove one bolt and the ground strap from the body.

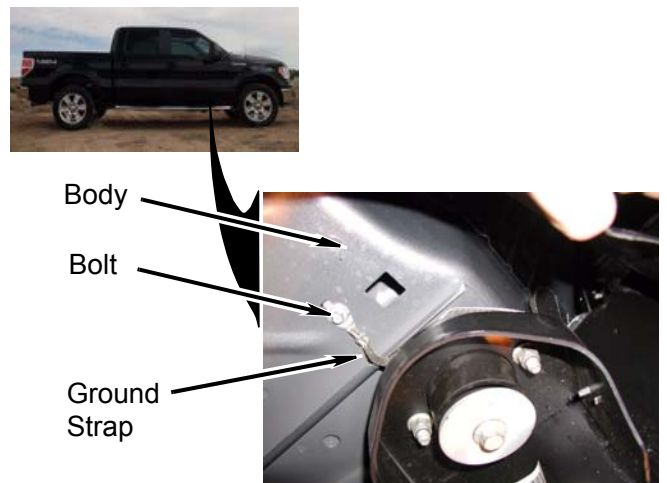

- c. Remove one bolt and the harness strap from the front inside passenger frame rail.

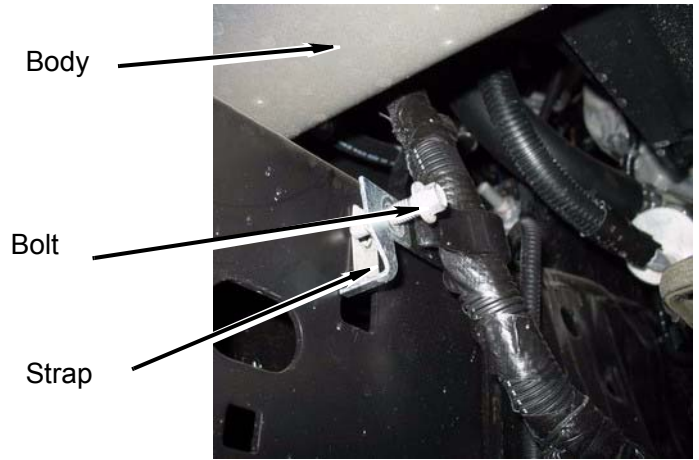

- d. Apply the parking brake.
- e. Clamp the parking brake cable with a pair of vice grips near the rear cable sheath that leads to the brake drum. This will prevent the brake spring tension from pulling the cable into the rear sheath.

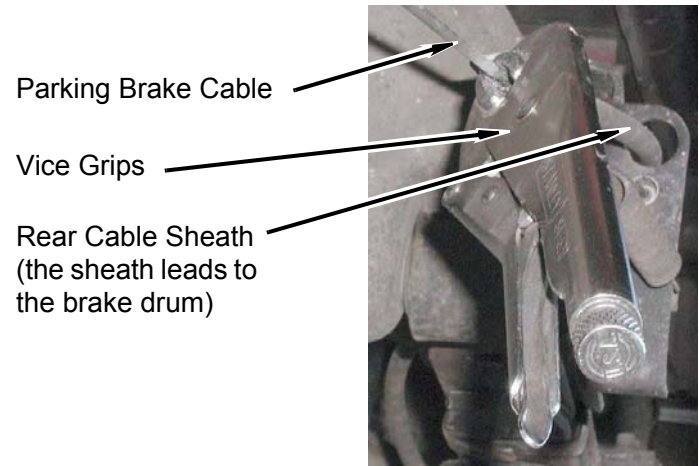

- f. Release the parking brake.
- g. Pull the front cable sheath toward the front of the vehicle (away from the cable mount) to remove the end of the sheath from the hole, then pull the cable out through the slot.

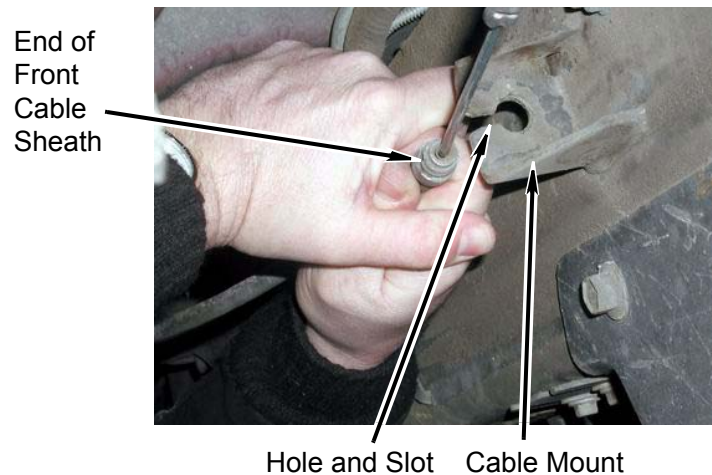

7. Inside the cab (steering U-joint)

⚠ WARNING

Accidental deployment of the air bag can result in serious personal injury or death. To avoid accidental deployment during installation of the lift kit, the Supplemental Restraint System (SRS) must remain deactivated. Do not allow anyone near the airbag during installation. Refer to the factory service manual or owner's manual for the recommended procedure to disable the SRS. After kit installation, the SRS must be reactivated before driving the vehicle.

⚠ CAUTION

If you fail to perform the following step, the airbag clockspring could be damaged if you turn the steering wheel while the steering shaft is disconnected.

- a. Set the front wheels straight ahead and center the steering wheel. Strap the steering wheel so it can't be accidentally turned.
- b. Under the dash, remove the steering U-joint bolt. Slide the U-joint down to separate it from the steering wheel shaft.

8. (Vehicles with manual-shift 4WD) Inside the cab (transfer case shift lever)

- a. Ensure the transfer case is in Neutral.
- b. Remove the shift knob from the transfer case shift lever.
- c. Remove four screws and the upper shift boot from the lower shift boot.
- d. Remove four bolts and the lower shift boot from the cab floor.
- e. Remove one bolt and the transfer case shift lever from the linkage.

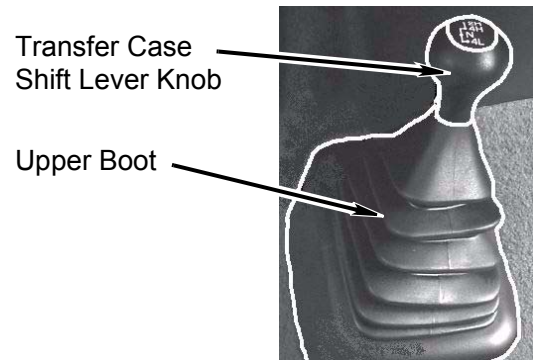
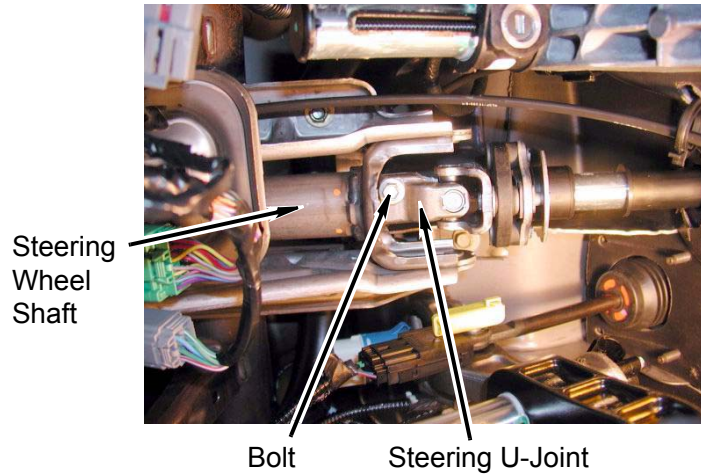

9. Fuel filler

⚠ WARNING

Use extreme caution when working near the fuel lines and the fuel tank. Clean up spilled fuel immediately. A spark could cause an explosion or fire resulting in serious personal injury and property damage.

- a. Remove the Easy Fuel clip.
- b. Remove three bolts and the fuel filler assembly from the bed side.

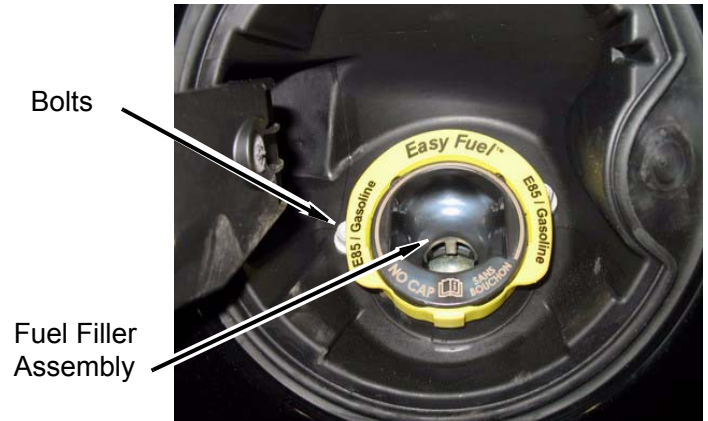

- c. Loosen the hose clamp holding the fuel filler assembly to the bed mounting tongue. Slide the clamp away from the tongue to allow the fuel filler assembly to separate from the tongue and bed during lifting.

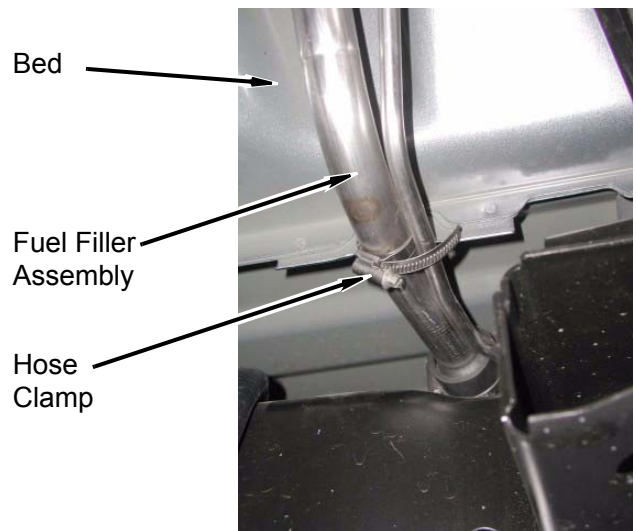

10. Remove the spare tire (refer to the owner's manual).

11. Rear bumper

- a. Measure and record the distance between the rear bumper and the bottom of the tailgate (driver and passenger sides) for future reference.

Driver Side _____ Passenger Side _____

- b. Disconnect two license plate light connectors from the rear bumper (**Note:** Some vehicles may be equipped with rear backup sensors. You will need to disconnect the sensors and harness from the bumper).
- c. Disconnect the wiring harness clip from the hole in the rear bumper frame and bumper. Be sure that all of the wires are disconnected

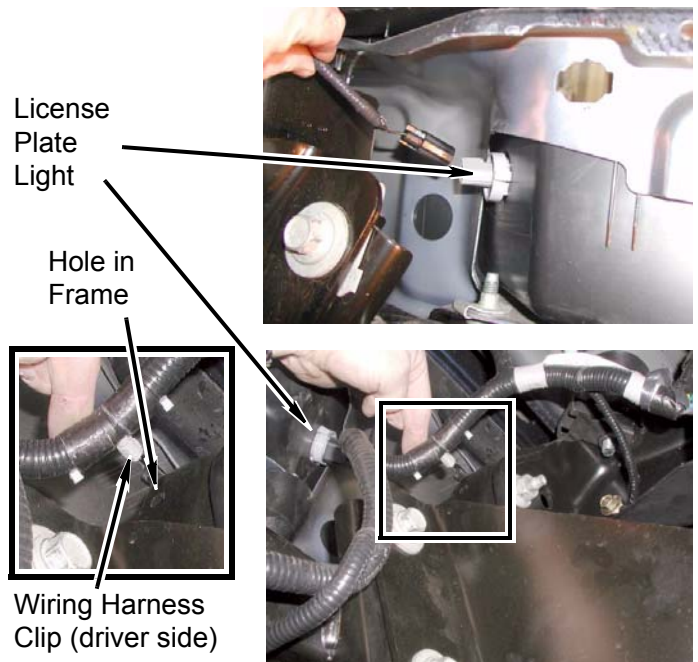

- d. Trailer tow electrical connectors: Slide the small (4-pin) connector out of the flange. Remove the gray plastic lock from the large connector, then disconnect the large connector from the bumper.

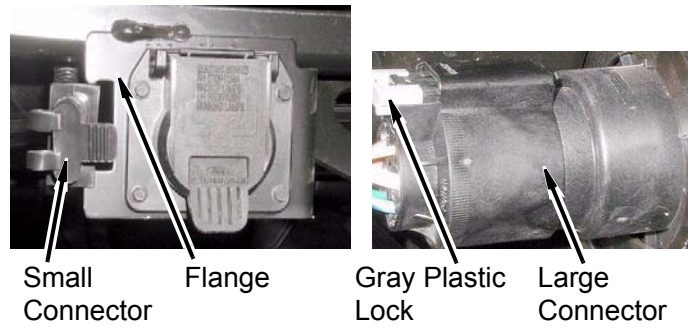

- e. Tow hitch models: Remove six nuts, six bolts and rear bumper from frame rails.

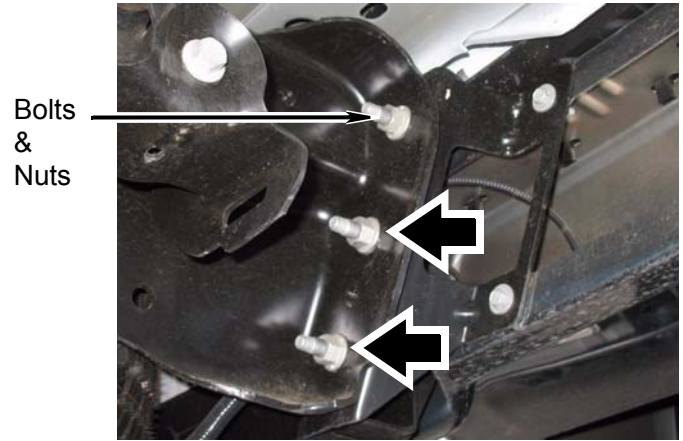

C. Install the *kit* lift blocks (cab)

⚠ !WARNING! ⚠

The factory cab bolts under **NO** circumstance should ever be removed with a impact wrench or gun. Damage will occur to factory capture nuts inside of body channel and make it extremely difficult to remove factory cab bolts. Please follow OEM procedure in removing cab mounting bolts.

- Slide the bed rearward.
 - Measure and record the distance between the cab and the bed for future reference.
 Driver Side _____ Passenger Side _____
 - Using a T-47 Torx head bit, remove the bed-to-frame mounting bolts.
 - Slide the bed rearward (away from the cab) about 1". Ensure the fuel filler does not get hung up on the bed.



- Remove the factory bolts from C1P, C2P, C3P, and C4P.
- Remove bolts from C2D and C3D. Loosen, but do not remove C1D and C4D.

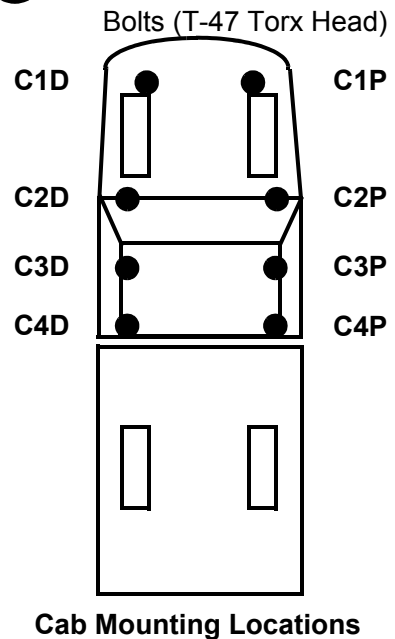

⚠ WARNING

Use extreme caution when lifting the body from the frame. To prevent serious personal injury, ensure the lifting device is securely placed. Keep your hands out from between the body and frame.

⚠ CAUTION

To prevent damage to the vehicle while lifting the cab, continually check hoses, wires, brake lines, etc. to ensure everything is flexing properly and not binding. It may be necessary to bend the brake lines to gain ample slack. Ensure clearance between bed and cab are maintained.

- a. Using a hydraulic jack and a wooden block, slowly lift the passenger side of the cab just high enough to place the lift blocks on the factory body mounts.

⚠ WARNING

The kit lift blocks must be installed *in addition to* the factory body mounting bushings. Failure to reinstall the factory bushings in their original (stock) locations could result in serious personal injury or damage to the vehicle.

4. Install a *kit* lift block (3" x 3") on top of factory bushings C1P, C2P, C3P, and C4P.
5. Temporarily install a *kit* bolt (12mm-1.75 x 200mm) in bushings C1P, C2P, C3P, and C4P. **Do not tighten.**
6. Lower the cab onto the *kit* lift blocks.
7. Remove factory bolts from C1D and C4D.
8. Using a hydraulic jack and a wooden block, slowly lift the drivers side of the cab just high enough to place the lift blocks on the factory body mounts. Install the *kit* lift blocks on the driver side of the cab.
9. Be sure that the cab has not shifted. If so, align cab by shifting it on the frame.
10. Remove the *kit* bolts one at a time, coat the threads with Loctite®, install, and tighten to 55 lb-ft.

Kit Lift Block (3" x 3")

Bushing (factory)

Bushing Bottom Plate

Typical Lift Block Installation

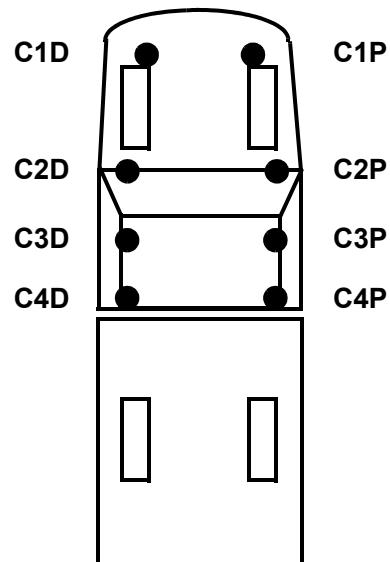
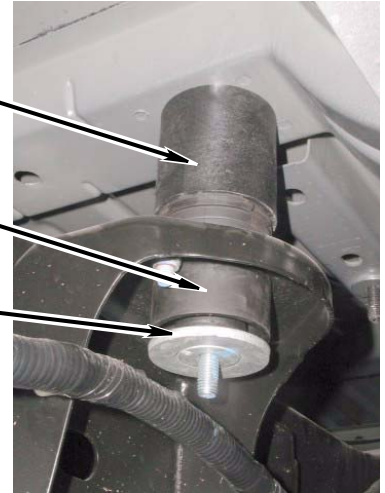

Cab Mounting Locations

D. Install the *kit* lift blocks (bed)

1. Slide the bed forward (toward the cab) until the bed is near its original position.
2. Using a hydraulic jack and a wooden block on each side of the bed, slowly lift the front end of the bed just high enough to install the *kit* lift blocks.

△ NOTE

If a factory plastic piece is installed in any of the bushing mount holes on the frame, remove it.

3. Install two *kit* lift blocks (3" x 3") on the frame at the front mounting pads.

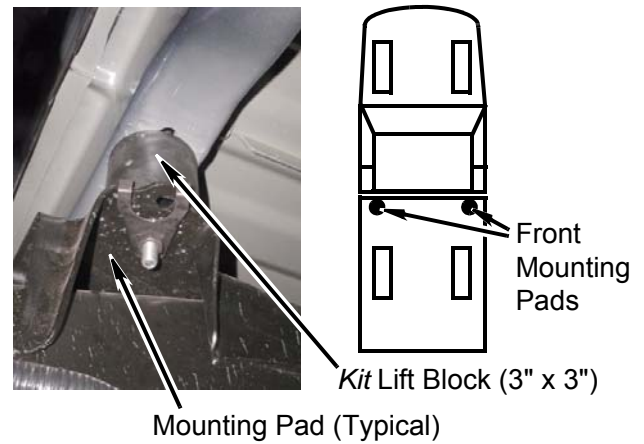

4. Lower the front end of the bed onto the *kit* lift blocks.
5. Using a hydraulic jack and a wooden block on each side of the bed, slowly lift the rear end of the bed just high enough to install the *kit* lift blocks.
6. Install a *kit* lift block at all other frame mounts (four mounts on vehicles with 5 1/2' bed and 6 1/2' bed; six mounts on vehicles with 8' bed).
7. Lower the bed onto the *kit* lift blocks.
8. At each bed mount, install a *kit* bolt (12mm-1.75 x 180mm) through a *kit* washer (1/2" x 1 3/4" plated), the bed, the *kit* lift block, and the frame mounting pad. DO NOT tighten.
9. Position the bed according to the measurement in step C.1.a.
10. Remove the *kit* bolts one at a time, coat the threads with Loctite, and install. Tighten the 12mm *kit* bolts to 55 lb-ft.

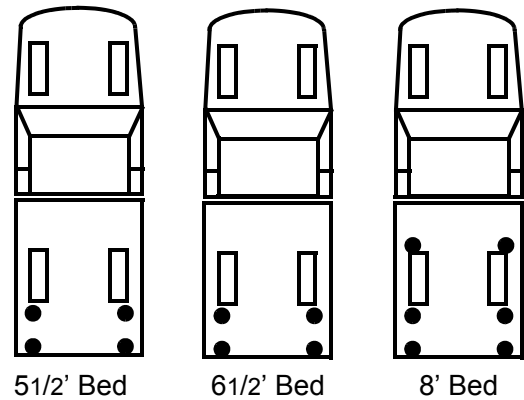

Mounting Pads
(Except Front)

E. Modify the spare tire mechanism

1. Remove two bolts and the spare tire cranking mechanism from the mounting plate.

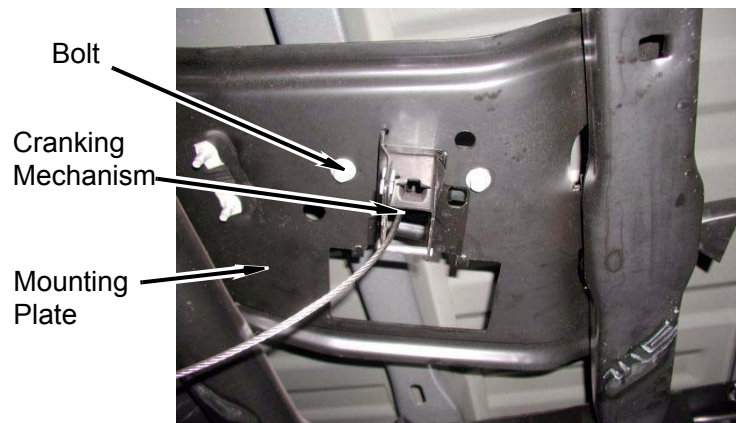

2. Install two *kit* lift blocks (3" x 2") and the cranking mechanism on the mounting plate with two *kit* bolts (10mm-1.5 x 100mm) and *kit* washers (3/8").

Kit Bolt (10mm - 1.5 x 100mm), Washer (3/8")

Kit Lift Block (3" x 2")

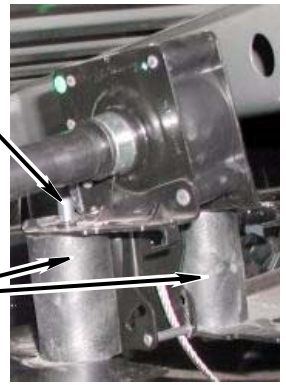

3. Insert the guide tube through the hole in the *kit* bracket.
4. Install the *kit* bracket and guide tube on the spare tire mounting plate using a *kit* bolt (3/8" x 1"), *kit* washer (3/8"), and *kit* nut (3/8" Nylock).

Guide Tube

Kit Bracket

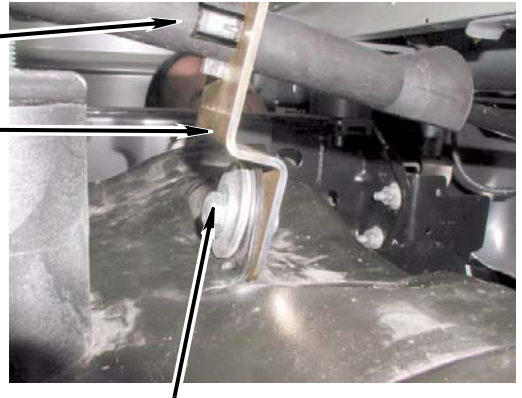

Kit Bolt (3/8"-13 x 1"), Washer (3/8"), Nut (3/8" Nylock)

F. Rear Bumper

1. Remove six bolts and bumper support (or hitch) from bumper..

Bolts

Bumper

Bumper Support

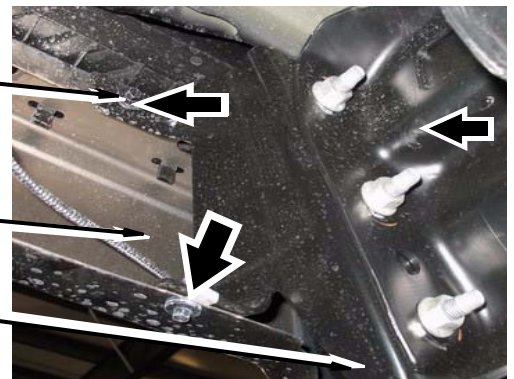

2. Mark and cut passenger side lower bumper support bracket off of rear bumper support. Repeat to driver side.

Hitch

Cut along line

Bumper support bracket

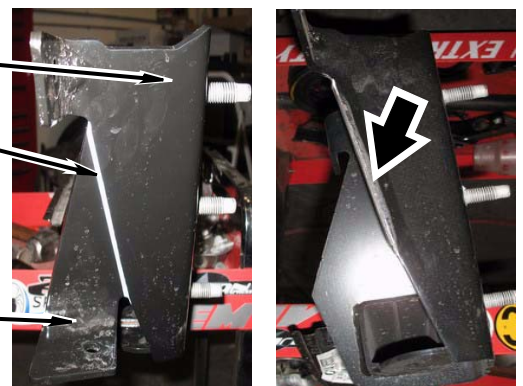

3. Install *kit* brackets (bumper, rear) onto rear bumper support driver and passenger side with six *kit* bolts (5/16" x 1"), twelve *kit* washers (5/16" SAE) and six *kit* nuts (5/16" Nylock). Be sure to align bracket so that it is centered in the hitch mounts. Then tighten bracket to hitch mounts.

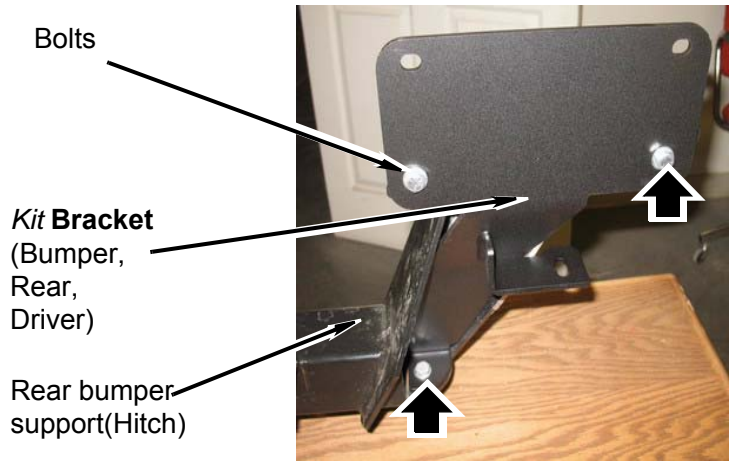

4. Mark and Drill(5/16" Drill) driver and passenger sides bumper(Hitch) as shown . Then place 1" studded bracket into place and tighten all hardware to secure bumper bracket. (**Note:** Not all bumper brackets will require this modification.)

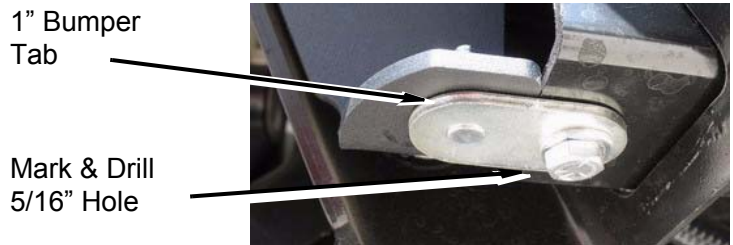
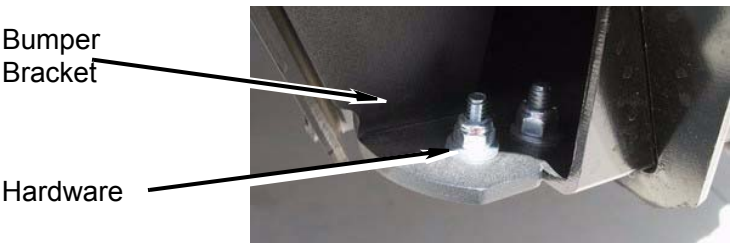

5. Mark and cut driver and passenger sides of bumper as shown (Bumper will clear hitch and bumper support when raised 3"). (**Note:** For best results, mount bumper and check clearance. Remember to mark and cut as little as needed. Some Bumpers will not need to be cleared.)

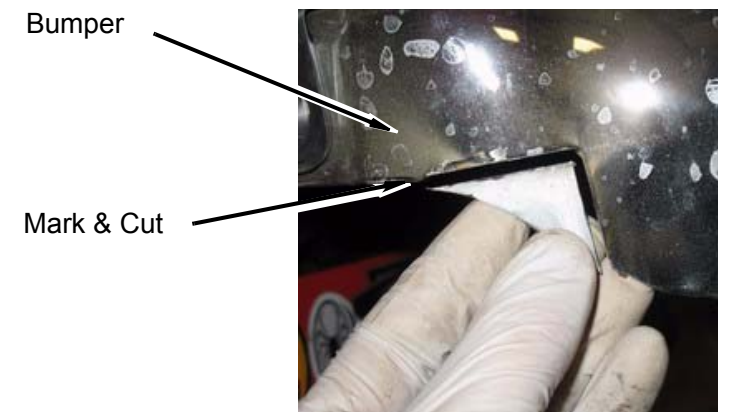

6. Install *kit* bracket (bumper, rear) onto driver and passenger side bumper with four O.E. bolts. Use two *kit* bolts (5/16" x 1"), four *kit* washers (5/16" SAE) and two *kit* nuts (5/16" Nylock) on lower bumper support mount DO NOT TIGHTEN.

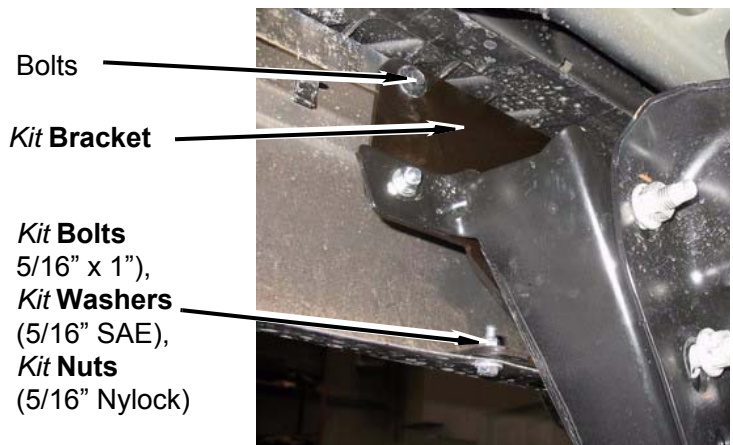

7. Position *kit* bracket (bumper, rear, middle) between bumper and bumper support.

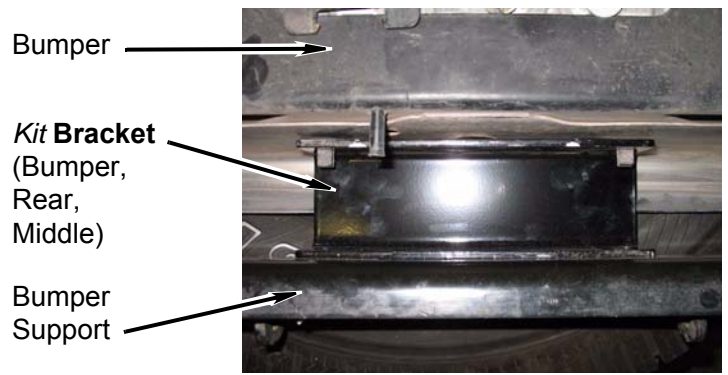

8. Mark and drill 7/16" holes in to rear center bumper support.

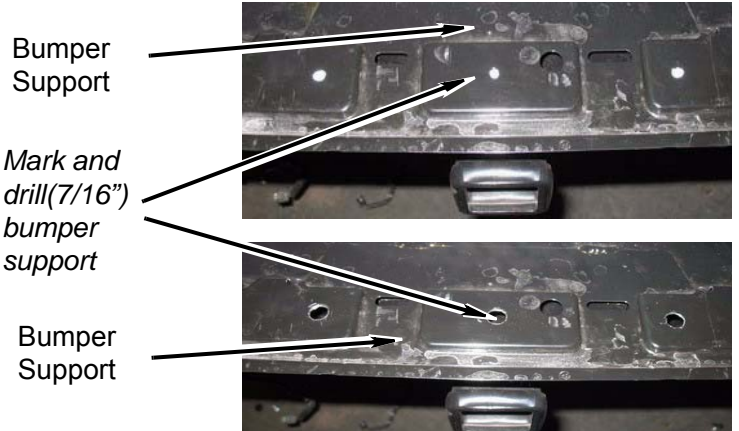

9. Install *kit* bracket (bumper, rear, spacer) onto bumper support with three *kit* bolts (7/16" x 1"), six *kit* washers (7/16" SAE) and three *kit* nuts (7/16" Nylock).

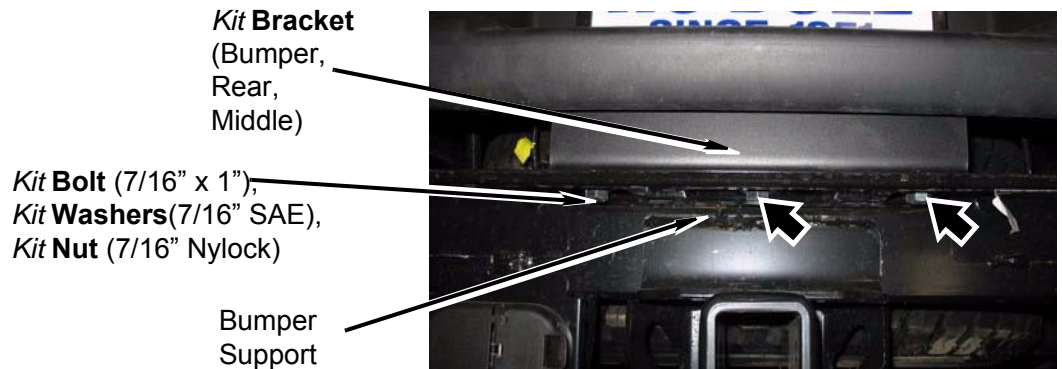

10. Install hitch and bumper assembly onto vehicle with six O.E. bolts and nuts. Adjust bumper to previous measurements and **tighten all hardware**.



11. Connect two license plate lights in rear bumper.

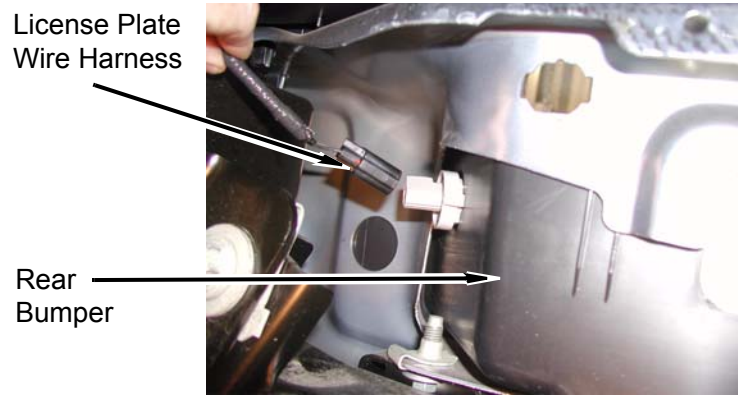

12. Install trailer light wiring harness onto bracket. Use supplied zip ties to secure any loose hanging wires.

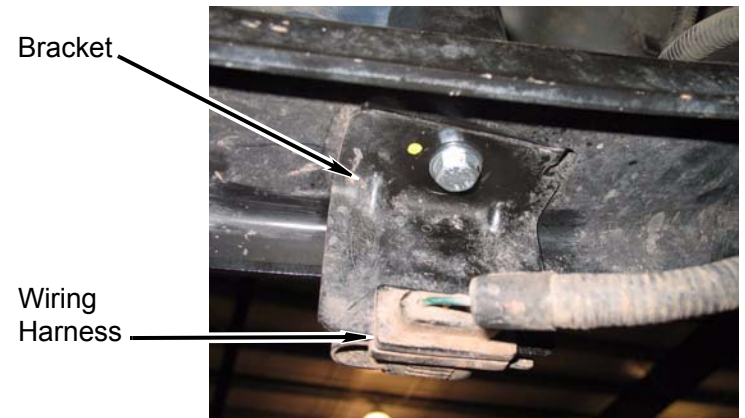

13. Trailer tow electrical connectors: Install large connector onto bumper. Install small (4-pin) connector into flange.

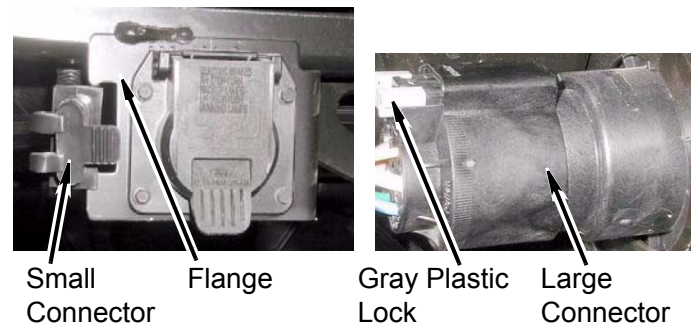

G. Install the *kit* bed crush blocks

1. Set a *kit* crush block into position on each frame mounting pad. (**Note:** You may also weld block to the frame rail)
2. At each *kit* crush block, install a *kit* bolt (7/16" x 1"), two *kit* washers (7/16"), and a *kit* nut (7/16" Nylock).

Tip: To install the washer at the bolt head, use a screwdriver to push the washer through the bed channel into position above the crush block. To install the bolt, put a piece of duct tape on the end of a screwdriver with the sticky side of the tape exposed. Set the bolt on the tape and install the bolt.

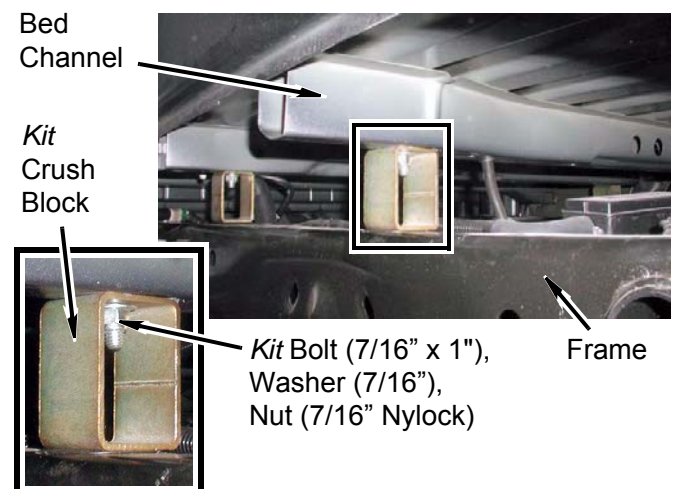

H. Extend the fuel filler hose

⚠ WARNING

Use extreme caution when working near fuel lines and the gas tank. Clean up spilled fuel immediately. A spark could cause an explosion or fire resulting in serious personal injury and property damage.

1. Remove the clamp holding the filler hose to the gas tank. Disconnect the filler hose from the gas tank.
2. Install the *kit* pipe (1 1/4" x 2 1/2"), *kit* hose (1 3/8" x 2 1/4"), two *kit* clamps (#28), and the clamp between the filler hose and the gas tank.
3. Gently bend the fuel tank vent tube to relieve tension on the gas tank and rubber vent hose.
4. Install the fuel filler assembly on the bed with three bolts.
5. Install the fuel filler neck on the bed mounting tongue with the clamp.

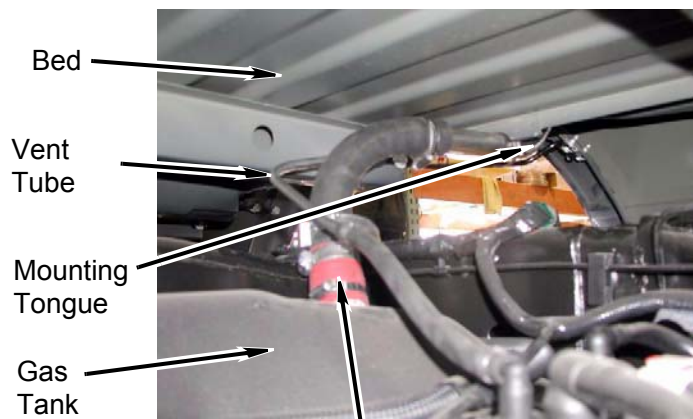
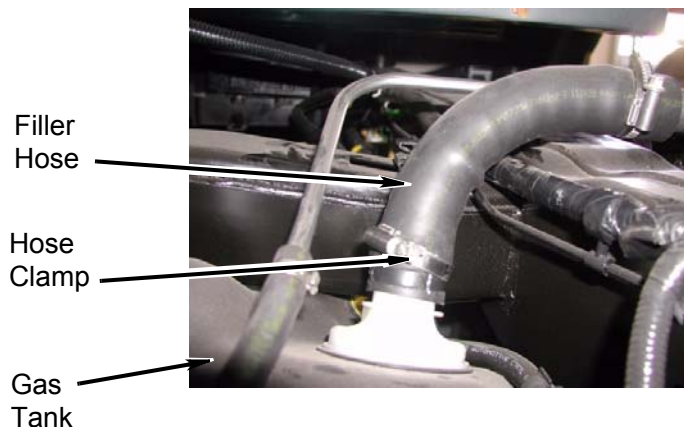

Kit Hose (1 3/8" x 2 1/4"), Clamp (#28)

6. Install the Easy Fuel clip.

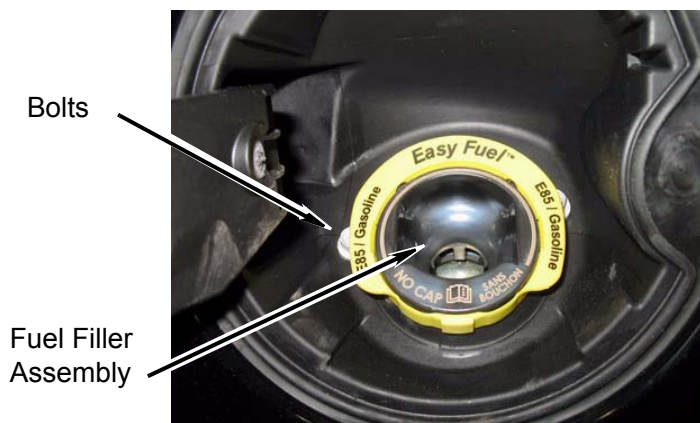

I. Install components under the vehicle

1. Connect the ground strap to the body with the bolt, near bushing C2P.

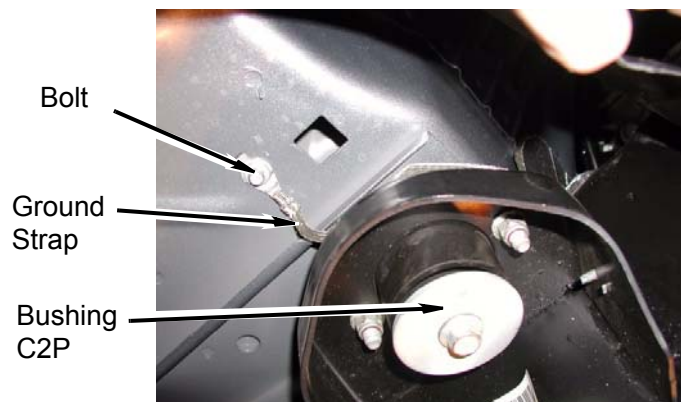

J. (Vehicles with manual-shift 4WD)

Extend the transfer case shift lever

⚠ WARNING

During cutting and welding, be careful not to damage any of the parts attached to the shift levers. A certified welder should perform all welding.

1. Scribe a line along the side of the transfer case shift lever (above the bend). Cut the lever into two pieces through the line and deburr as necessary.
2. Position the *kit* transfer case shift lever extension between the two pieces of the transfer case shift lever.
3. Ensure the lines that you scribed are aligned, then weld the extension in place.
4. Slide the upper shift boot and lower shift boot onto the transfer case shift lever.
5. Install the transfer case shift lever onto the linkage with the bolt. Check the operation of the transfer case shift lever.
6. Set the lower shift boot into position through the hole in the cab floor and install it on the transfer case with four bolts.
7. Install the upper shift boot on the cab floor with four screws.

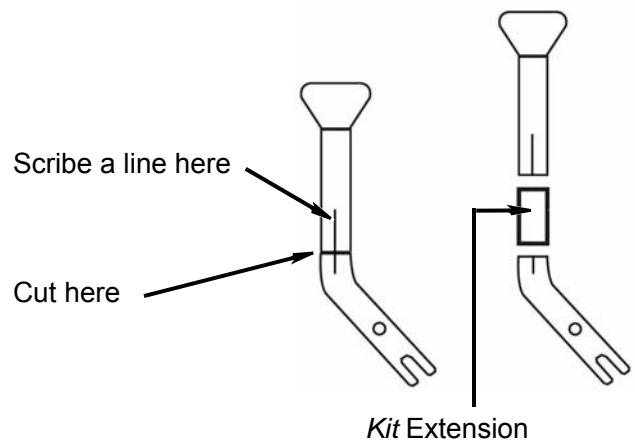

K. Install the *kit* steering extension

1. Position the *kit* steering extension on the steering wheel shaft. Tighten the *kit* bolt (3/8"-24 x 1 1/4" socket head) to 33 lb-ft.
2. Slide the steering U-joint onto the *kit* steering extension.
3. Ensure the steering wheel has not turned. Tighten the bolt to 33 lb-ft.

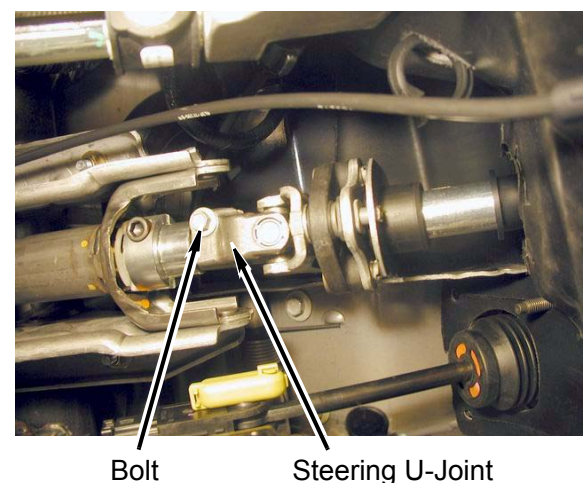
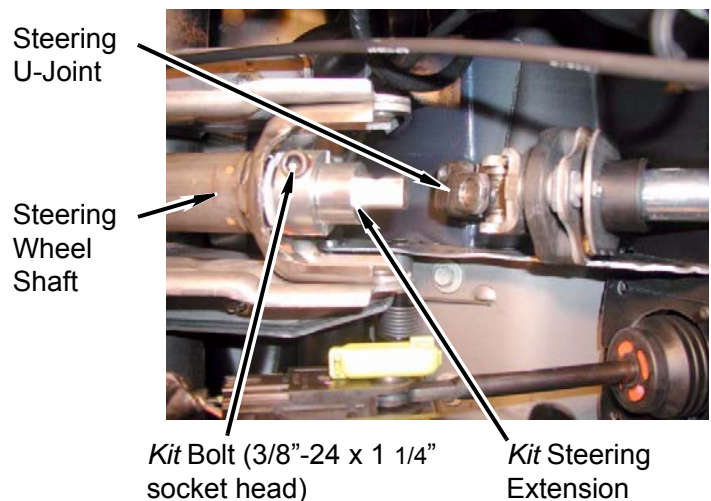
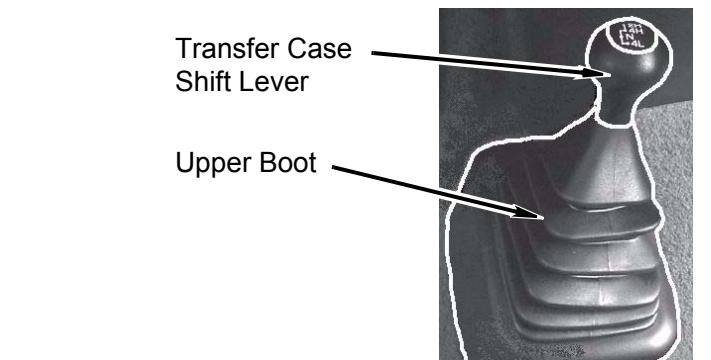

4. If equipped with adjustable pedals, operate the brake pedal button to ensure there is no interference with the steering U-joint or solenoid. If interference exists, slightly bend the brake pedal sideways.

L. Install the *kit* components under the hood

1. ABS brake controller bracket

- a. Install the two *kit* spacers on side of the frame with the supplied bolts(8mm-1.25 x 35mm). For top hole, drill (5/16") hole 5/8" toward the inside of frame into the OEM bracket. Secure ABS bracket with O.E. bolt.

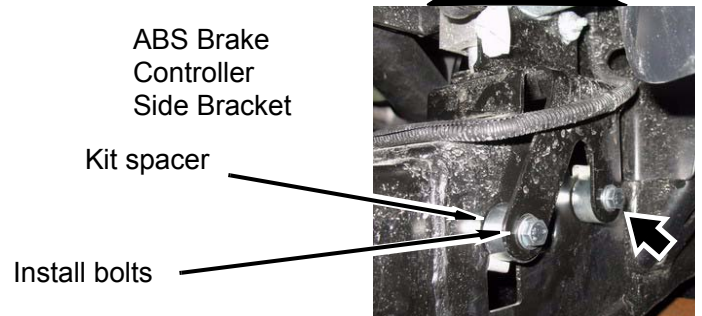

2. Ground strap connection at firewall

- a. Install the *kit* bracket (flat, 3") on the firewall with OEM bolt.
- b. Install the ground strap on the *kit* bracket with a *kit* nut (1/4" Nylock) and *kit* washer (1/4").

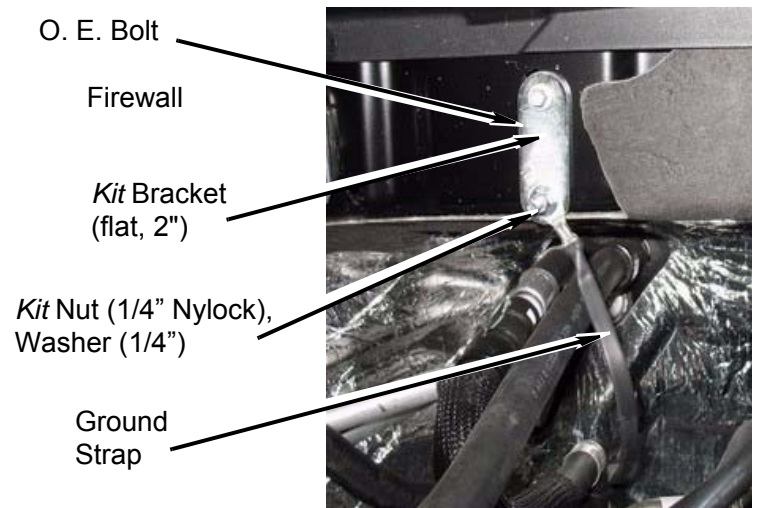

3. Fan shroud modification

⚠ NOTE

Some vehicle models **do not** have a mechanical fan. Please **skip** the fan shroud steps taken when the truck has a electric fan. The fan shroud will not need drop down brackets on these trucks.

- a. Locate both(side) fan shroud block off plates and position them so they are centered on the upper fan shroud. Clamp block off plates so they are secured. Now position lower fan shroud and secure it to both block off plates.

Clamp block off plates on to fan shroud



- b. Mark and drill six 1/4" holes into the fan shroud tabs for each block off plate.

Mark and drill six 1/4" holes on each block off plate

Center and clamp the center block off plates

Fan shroud

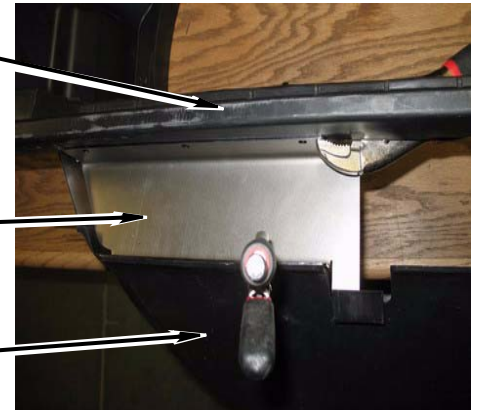

- c. After you have finished drilling for the side block off plates, take both center block off plates, center and clamp them to both upper and lower shrouds. Mark and drill six 1/4" holes into the fan shroud tabs for each block off plate.

Upper fan shroud

Fan shroud passenger side block off plate.

Lower fan shroud

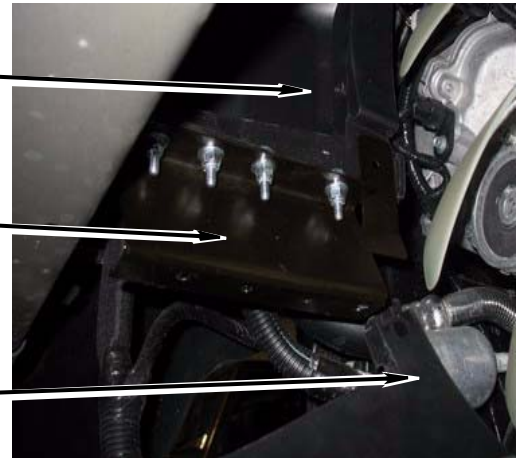

- d. After you have finished drilling all your holes use kit bolts(1/4"-20 x 3/4") to secure both side block off plates to upper fan shroud. Place upper fan shroud back in to stock mounting location. Secure upper fan shroud with OEM hardware.

- e. Using kit bolts(1/4"-20 x 3/4"), secure both center block off plates to upper fan shroud.

Radiator core support.

Fan shroud center block off plate.

Lower fan shroud



- f. Center lower fan shroud on all brackets(Center and Side Brackets). Use kit bolts(1/4"-20 x 3/4") to secure lower fan shroud to brackets. After you have aligned all holes and placed bolts into place, **tighten all hardware.** (Note: Be sure to check your lower radiator hose for clearance near power steering pump and shroud to ensure no damage will occur to hose.)

M. Engine compartment

1. Upper engine compartment

- a. If necessary, use a *kit* cable tie to secure the battery cable to the A/C line as well as other loose wires and vacuum hoses in engine compartment.

Zip tie

Wire harness



- b. Install one OEM screw and install vacuum regulator back onto fan shroud.

Fan shroud

Remove Screw

Remove vacuum regulator



- c. Install fuse box on radiator core. Secure using four OEM bolts

Fan shroud

Remove Screws

Remove fuse box



2. Power steering hose

- a. Drain and remove power steering reservoir. Mark and cut power steering line as shown.

Drivers side valve cover

Mark and cut power steering hose

Power steering hose near reservoir



- b. Use kit clamps and 4" hose extension to extend power steering hose. Be sure that your scribe marks line up. You will need about a 3" gap between the ends of each hose. Insert hose extension into hose at each end and use ring clamps to tighten the extension in place.

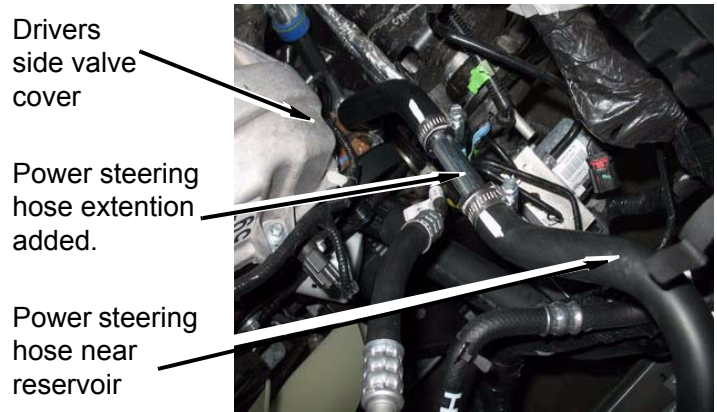

- c. Install power steering hose back onto reservoir. Install power steering reservoir on fan shroud using one OEM bolt. Refill power steering reservoir with OEM power steering fluid.

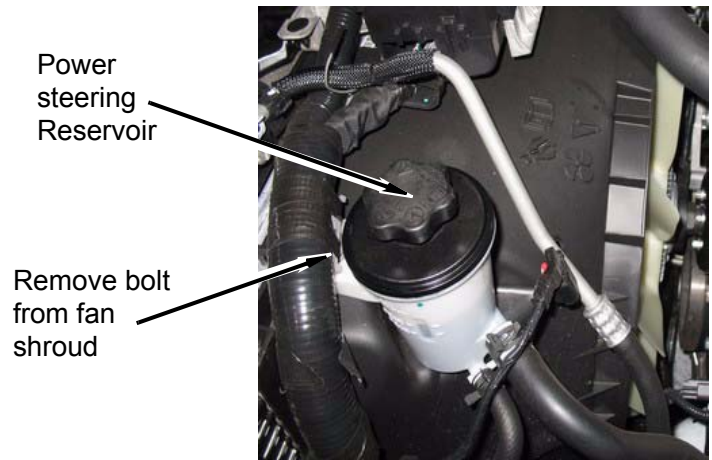

3. Upper radiator hose & extras

- a. As an extra precaution to protect the upper radiator hose, mark & drill two 1/4" holes parallel to each other (about 2" apart) near the edge of the fan shroud (centered to the hose). Next, use the supplied piece of (1/2" x 3") rubber hose & carefully cut one side of the rubber hose down the center.

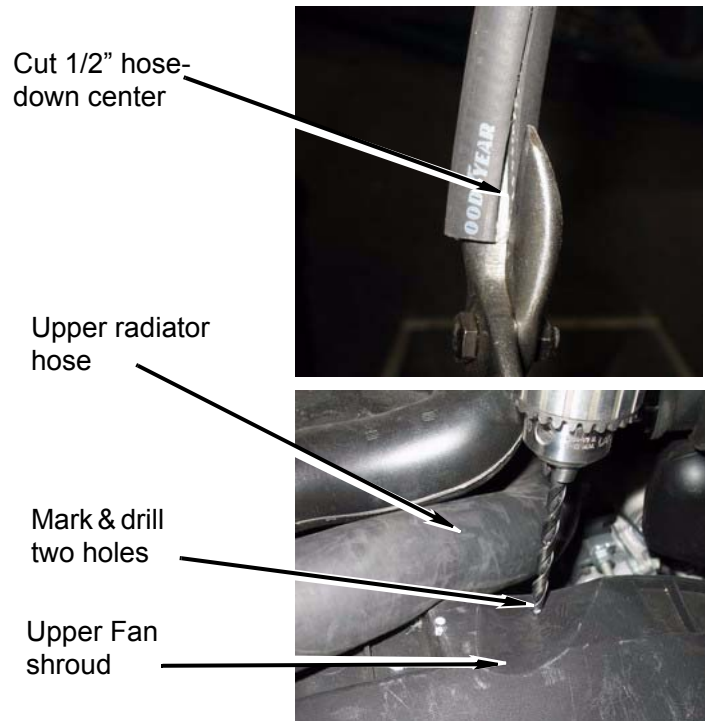

- b. After 1/4" holes are drilled into upper fan shroud, slide cut 1/2" section of hose over the edge of the fan shroud. Use zip ties to secure the 1/2" hose to the edge of the fan shroud (**Note:** Some modifications may need to be made to the upper fan shroud for proper fitment). Center the upper radiator hose over the 1/2" section of hose.

Upper Rad. hose

Ziptied 1/2" hose

Upper fan shroud



- c. Remove old power booster vacuum hose and install new kit hose (1/2" x 6"). Use OEM clips to secure hose. Install vacuum hose back into power booster and hard line from engine.

Brake booster valve

New brake booster hose.

Old hose



- d. Place harness strap back onto the front inside passenger frame rail using the OEM bolt (**Note:** some minor adjustments may need to be made to the strap so proper fitment is achieved).

Body

Bolt

Strap



4. Air intake duct

- a. Attach the air intake duct to the air filter housing and onto intake housing.

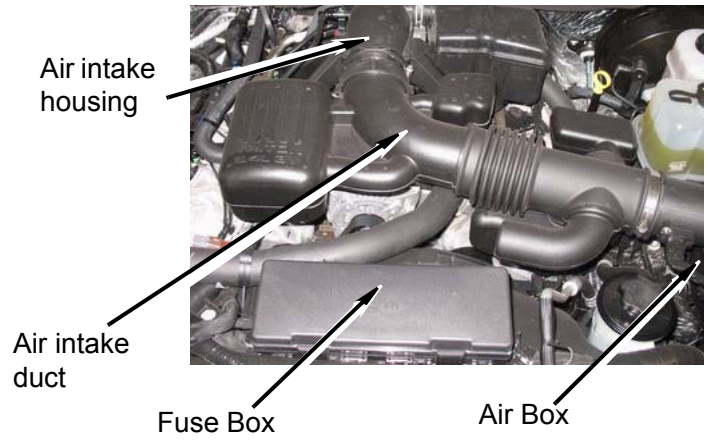

N. Install the front bumper

1. Mark, drill, and cut frame horns.

- a. Using kit bracket as template. Mark and cut along the top of the frame horns(2" strips). Be sure to cut all the way to the end of the frame so that there is no lip left. This will allow the bumper brackets to mount flush on the frame horn.

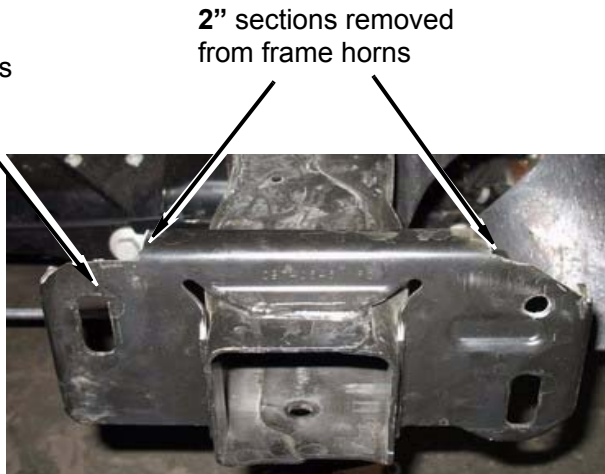
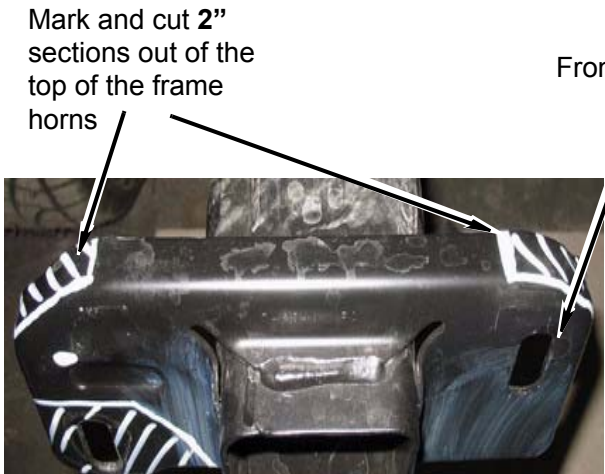

- b. Using a ruler(tape measure), measure (1 3/4") between the top of the slotted hole(on the outside of the frame horns) and center where you will mark. Once you have centered your hole position, drill a (9/16") hole. This hole should be parallel to the top of the slotted hole on the inside of the frame horns.

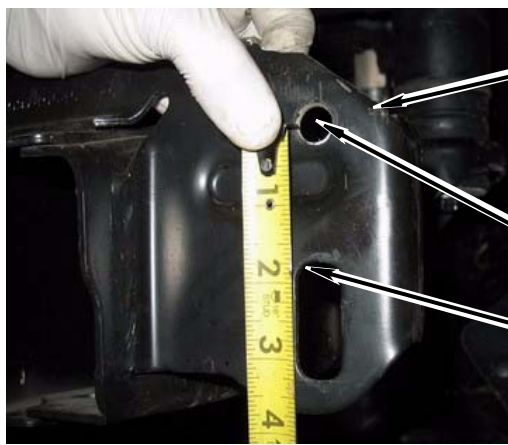

9/16" hole drilled out on both outside edges of frame horns



- c. Mark and cut(2 1/2" In x 1 1/2" Up) out of the **outside** lower corner(drivers side frame horn). Mark and cut(2 1/2" In x 3/4" Up) out of the **inside** lower corner(drivers side frame horn). Be sure to repeat steps to the passenger side frame horn.

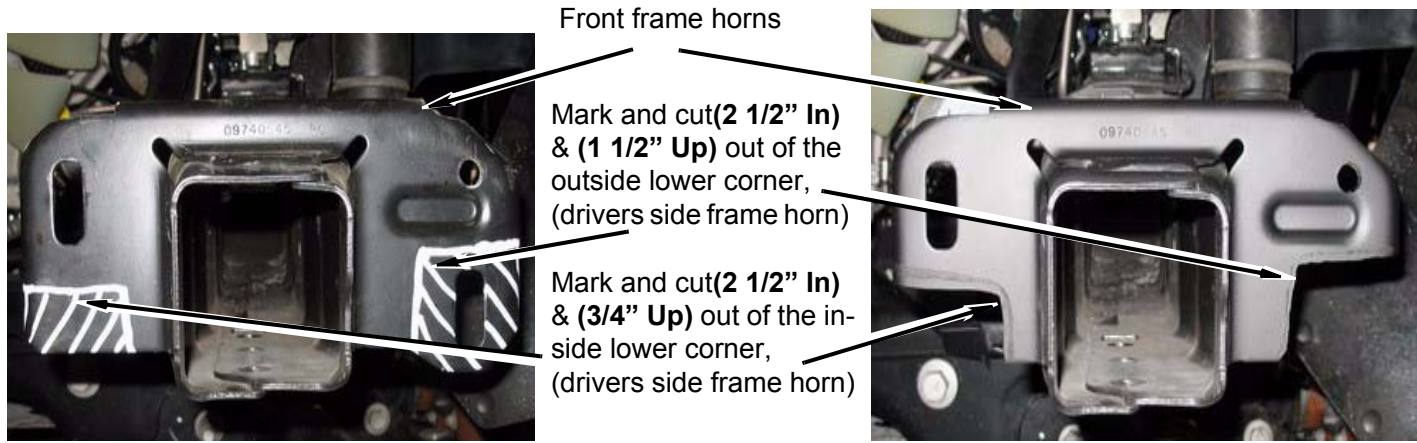

- d. When you are finished making your changes to the front frame horns, your finished product should look similar to the display below. Be sure to use rust protection after on any bare exposed metal.

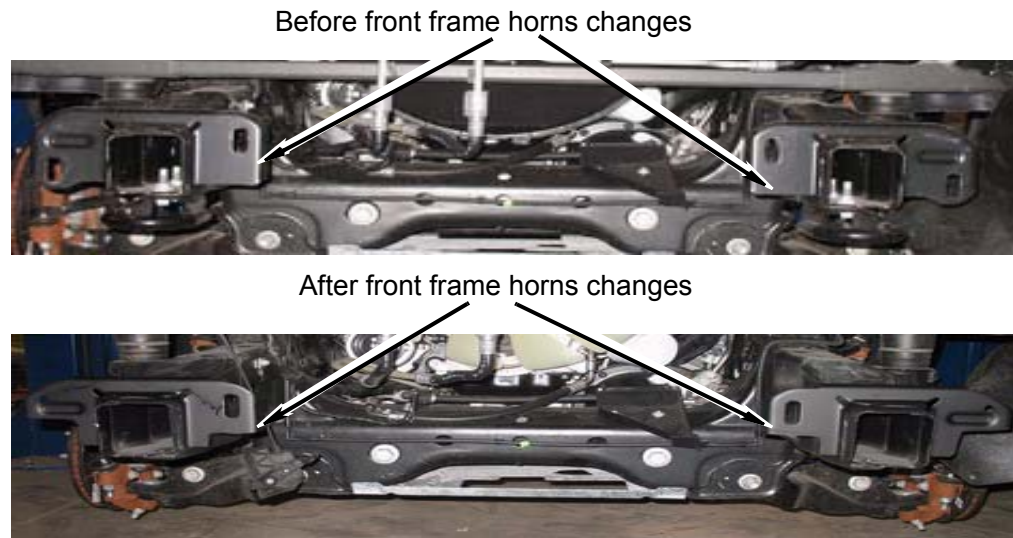

2. Mark and drill front bumper brackets.

- a. Remove both front bumper brackets from the front bumper by removing the four bolts that secure each bumper bracket. Continue by removing OEM studded bracket from bumper bracket.

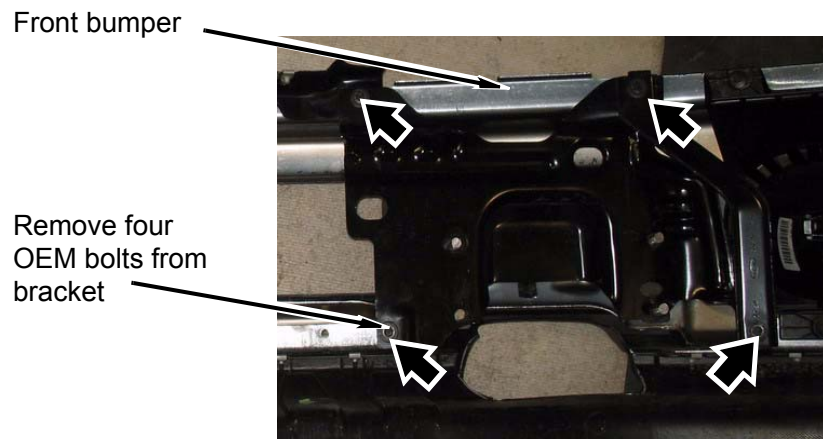

- b. Carefully use the **kit** studded bracket to mark where your new holes will be in the OEM bumper brackets. First step will be to mark a hole directly (**3" Down**) from the left side of the slotted hole on the passenger side bumper bracket. Once you have marked your spot, measure (**9" Across**), be sure that your marks are parallel to each other. Last step is to measure exactly (**3" Up**) vertical and mark the last hole location.

Front passenger side bumper bracket

Step 1: Mark a hole directly (**3" Down**) from the left side of the slotted hole on the passenger side bumper bracket.

Step 2: measure (**9" Across**), be sure that your marks are parallel to each other. Mark your second hole.

Step 3: measure exactly (**3" Up**) vertical and mark the last hole location.



- c. Your finished bumper bracket(marked) should look very similar to the one shown on the right. Be sure that your marks on the bumper bracket match up with the studded bracket when mated together.

Marks on pass. bumper bracket.

Bumper bracket



- d. Once you are sure your holes are in the correct position, drill **9/16"** holes at each mark.

Drill out pass. side bumper bracket.

Bumper bracket



- e. After you finish measuring and drilling your holes in both bumper brackets, check your fitment by using studded kit bracket to both OEM bumper brackets. (**Note:** If studs do not line up, make necessary changes to holes so that the studded bracket will fit centered on the backside of the OEM bumper bracket).

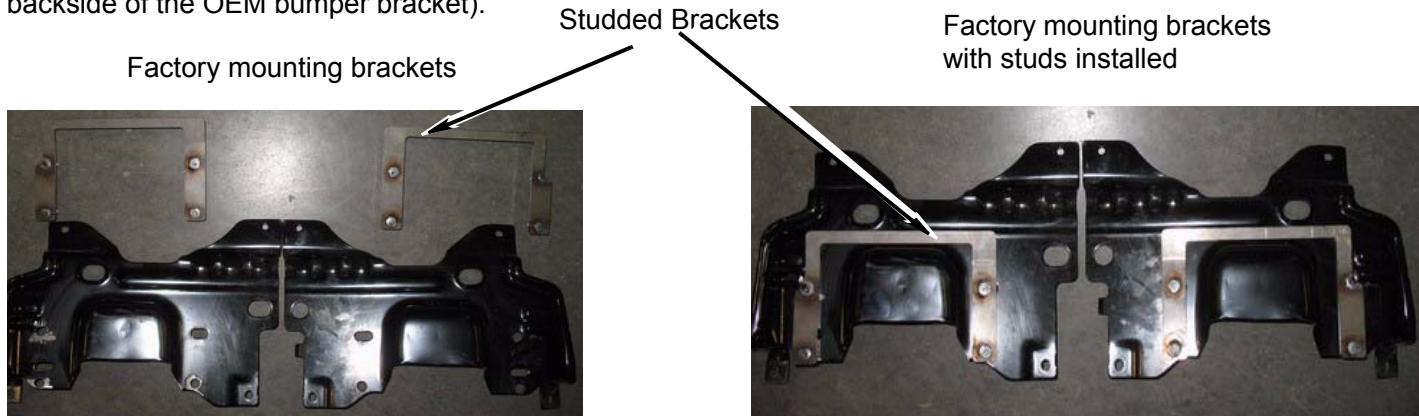

- f. Mark and trim front bumper so when front bumper is mounted, the frame horns will clear the bumper. (**Note:** Be careful not to cut too deep into sheet metal on bumper)

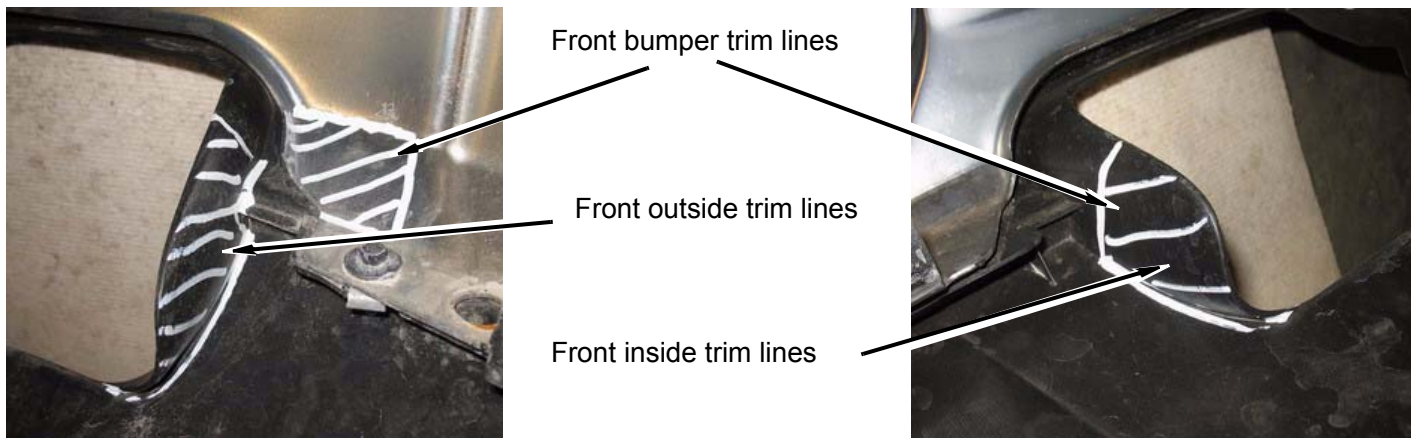

- g. After making your marks to both inside and outside sections on the driver and passenger sides, use trim tool to remove marked sections. (**Note:** Remember, always remove as little as possible, just enough to clear frame ends.)

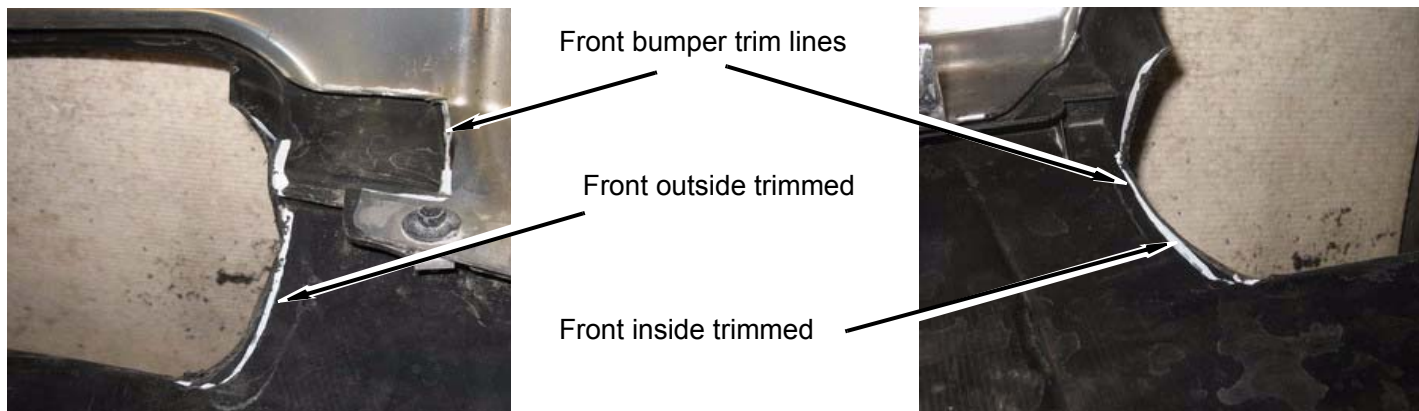

- h. After making your adjustments to the OEM bumper brackets. Place both right and left bumper brackets onto factory bumper with OEM bolts and tighten all OEM hardware.

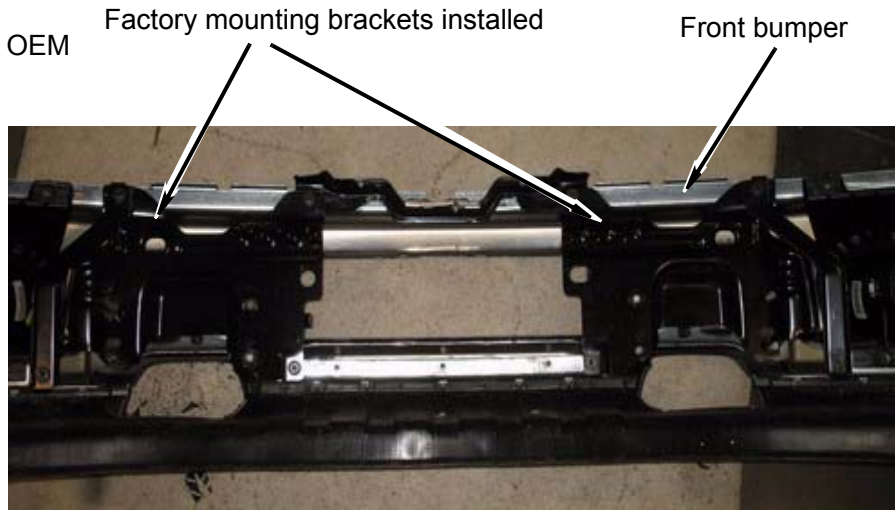

3. Installing front bumper

- a. Place front bumper into frame horns with lower studs in the two holes in the frame horns. Using kit bracket and hardware (1/2" washer and nut) to secure front bumper to frame horns. Use larger 1/4" thick washers between front bumper and kit bracket. (**Note:** Kit bumper brackets are notched for right and left sides. Be sure that each notch is toward the outside of the frame horns.)

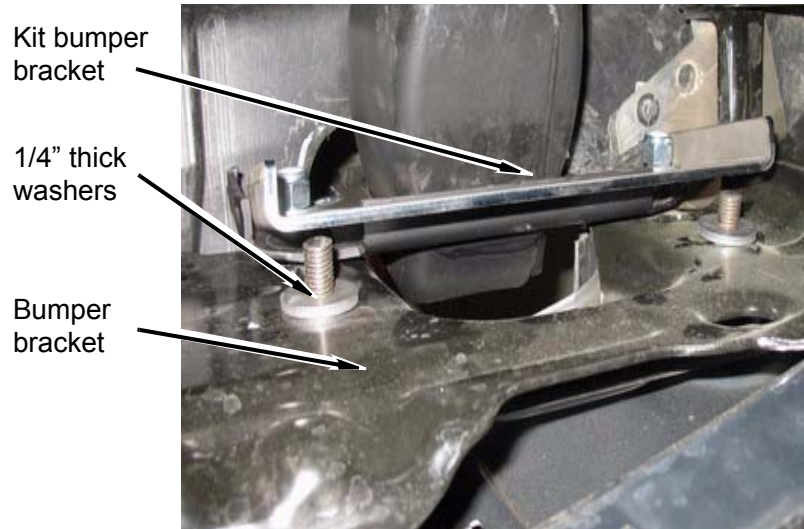

- b. Once you have all of your kit hardware in place, take the time to measure, align and center your bumper. Also make any extra trim cuts that may need to be addressed at this time. As soon as everything is lined up and trimmed, **tighten all hardware.**

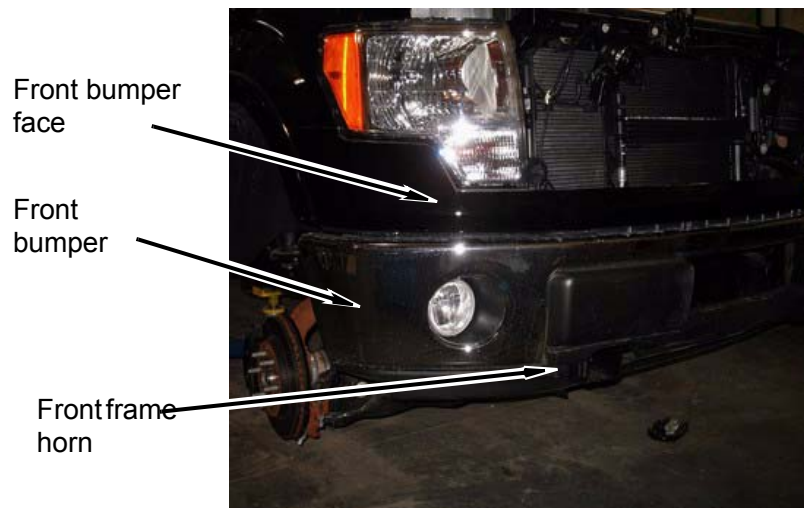

- c. Reattach the air flap to the radiator core support and bumper with push pins.

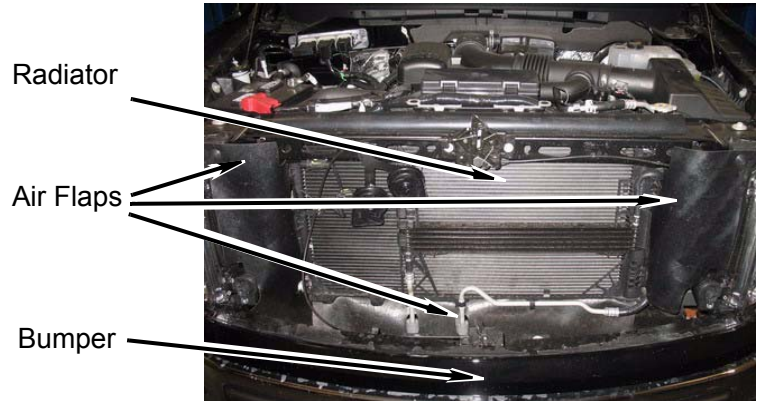

- d. Install the automatic transmission cooler hoses back into support clips on radiator core support.

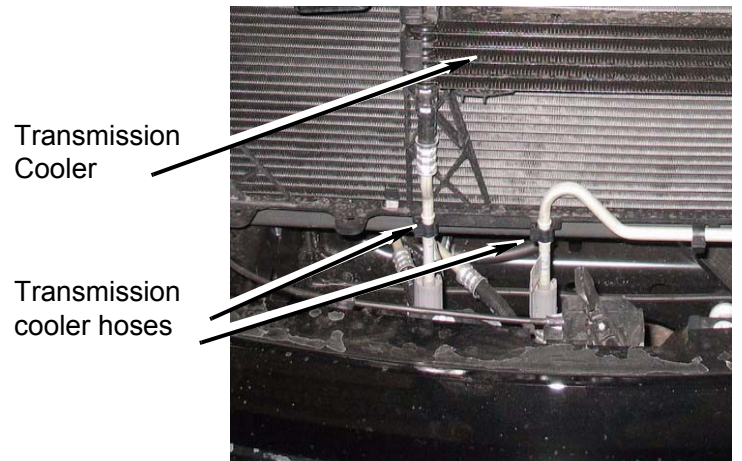

- e. Install one bolt and the hood release mechanism from the top of the front bumper. Install two OEM bolts that are attached to the top of the bumper.

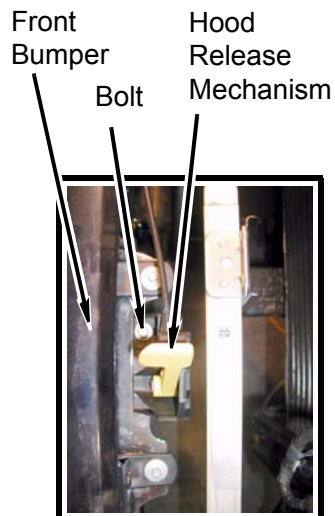

- f. Once bumper is installed, place kit frame horn plate into each frame horn. Use supplied kit hardware to secure block off plate(tow hook) to frame. (**Note:** Extra trimming may be necessary to clear tow hook.)

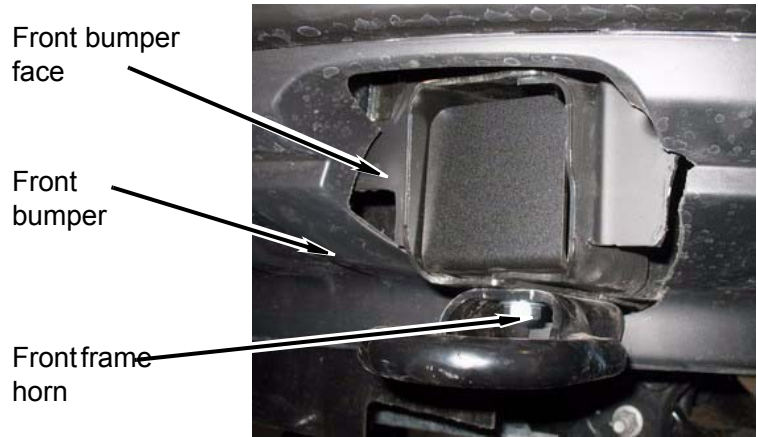

4. Finish installing the front bumper.

- a. (**Vehicles with fog lamps**) Connect the wiring harness connectors to the fog lamps.

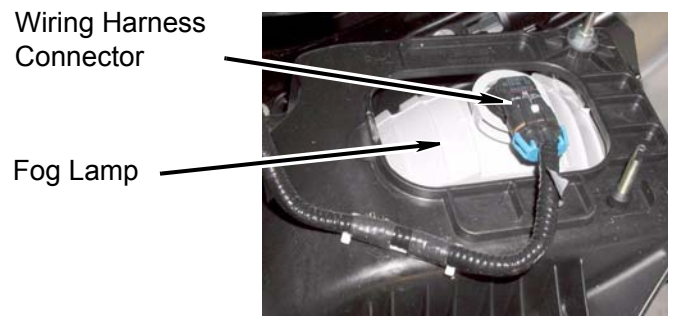

- b. Install the air flap on the front bumper and radiator lower support with nine *kit* push pins. If necessary, trim the air flap to prevent contact with the transmission cooler lines or power steering cooler lines.

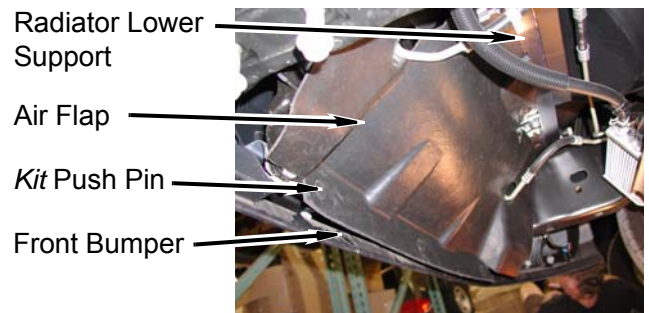

O. After installation is complete

1. Install the airbag fuses in the fuse panel. Install the two fuse panel covers.
2. Connect the positive cable to the battery, then the negative cable.
3. Start the engine, wait until the cooling system thermostat opens, completely fill the cooling system, then install the cap on the coolant overflow reservoir.
4. Apply the *kit* warning label to the dash in plain sight of all vehicle occupants.
5. Double check the vehicle.
 - a. Check all mounting hardware to ensure it is properly tightened.
 - b. Check all wires, hoses, cables, etc. to ensure they have been properly connected and there is ample slack.
 - c. Check the vehicle electrical system.
 - d. Start the engine. Turn the steering wheel all the way to the left and right to ensure no binding occurs.
 - e. Test-drive the vehicle: Check the operation of the clutch. Check the operation of the brake system and the parking brake. Ensure the transmission and transfer case shift properly. Pay close attention to all of the vehicle systems.
 - f. Check all of the hardware again after the vehicle has been driven 500 miles and as part of your regular maintenance schedule.

⚠CAUTION

Performance Accessories does not recommend any particular wheel and tire combinations for use with its body lifts and cannot assume responsibility for the customer's choice of wheels and tires. Reference your owner's manual for recommended tire sizes and warnings related to the use of oversized tires. Larger wheel and tire combinations increase stress and wear on steering and suspension components, which leads to increased maintenance and higher risk for component failure. Larger wheel and tire combinations also alter speedometer calibration, braking effectiveness, center of gravity, and handling characteristics. Consult with an experienced local off road shop to find what wheel and tire combinations work best with your vehicle.

⚠NOTE

All warranty information, instruction sheets, and other documents regarding the installation of this product must be retained by the vehicle owner. Information contained in the instructions and on the warranty card will be required for any warranty claims. The vehicle owner needs to understand the modifications made to his vehicle and how they affect vehicle handling and performance. Failure to provide the customer with this information can result in damage to the vehicle and severe personal injury.

Accessories

Kit# 6742 Gap Guards

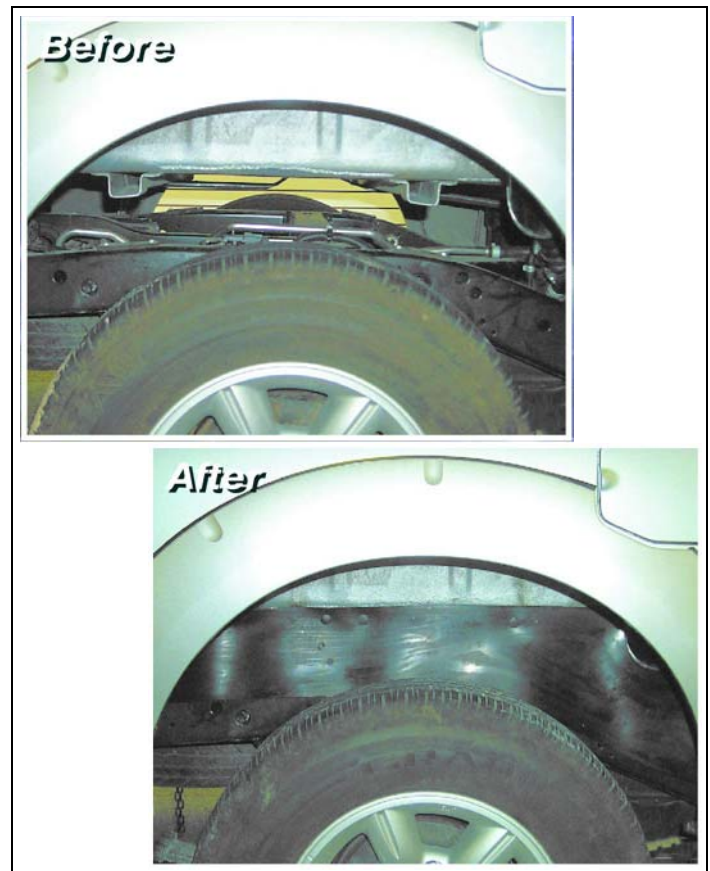

Kit Parts List

Quantity Description

4	Block, bed spacers
2	Block, lift, 3" x 2"
16	Block, lift, 3" x 3"
2	Bolt, 8mm - 1.25 x 35mm
2	Bolt, 10mm - 1.5 x 100mm
8	Bolt, 12mm - 1.75 x 180mm
8	Bolt, 12mm - 1.75 x 200mm
28	Bolt, 1/4" x 3/4"
11	Bolt, 5/16" - 18 x 1"
2	Bolt, 3/8" - 13 x 1"
1	Bolt, 3/8" - 24 x 1 1/4", socket head
3	Bolt, 7/16"-14 x 1"
4	Bolt, 1/2"-13 x 1"
2	Bracket, bumper, front, inner, studed
2	Bracket, bumper, front, large
1	Bracket, bumper, rear, driver
1	Bracket, bumper, rear, middle
1	Bracket, bumper, rear, passenger
1	Bracket, flat, 2" (hole-to-stud)
1	Bracket, flat, 3" (hole-to-stud)
2	Bracket, flat, 1" (hole-to-stud)
1	Bracket, parking brake cable
1	Bracket, spare tire mechanism, "Z"
8	Cable tie
2	Hose Clamp, #10
2	Hose Clamp, #28
1	Hose, fuel filler extension, 1 3/8" x 2 1/4"
1	Hose, power booster extension, 1/2" x 6"
1	Hose, fan shroud gaurd, 1/2" x 3"
1	Label, logo
1	Label, warning, general
1	Label, warning, rear bumper
1	Loctite
30	Nut, 1/4" - 20, Nylock
11	Nut, 5/16" - 18, Nylock
2	Nut, 3/8", Nylock
3	Nut, 7/16" - 14, Nylock
8	Nut, 1/2", Nylock

Quantity Description

1	Pin, shift extension, 1/2"
1	Pipe, power steering extension, 3/8" x 4"
1	Pipe, fuel filler extension, 1 1/4" x 2 1/2"
2	Plate, fan shroud block off, lower, center
1	Plate, fan shroud block off, lower, left
1	Plate, fan shroud block off, lower, right
2	Plate, frame horn (front bumper)
1	Steering extension
2	Spacer, ABS extension
60	Washer, 1/4 SAE
24	Washer, 5/16 USS
6	Washer, 3/8" USS
6	Washer, 7/16 USS
12	Washer, 1/2" USS
20	Washer, 1 3/4" OD, plated