



3651 N Highway 89 • Chino Valley, AZ 86323  
(928) 636-7080 • www.p-a-g.net

# FORD / MAZDA RANGER / B-SERIES P/U 3" BODY LIFT KIT INSTALLATION INSTRUCTIONS 2001-2011 KIT # 70033

**MANUAL TRANSMISSION VEHICLES  
REQUIRE KIT # 3700**

## ⚠WARNING

Installation of a Performance Accessories body lift will change the center of gravity and the handling characteristics of the vehicle. Because of the higher center of gravity and larger tires, the vehicle will handle and react differently both on and off road. You must drive it safely! Extreme care must be taken to prevent vehicle rollover or loss of control, which could result in serious injury or death. Avoid sudden sharp turns or abrupt maneuvers and always make sure all vehicle occupants have their seat belts fastened.

## ⚠WARNING

Read and understand all instructions, warnings, cautions, and notes in this sheet and in your owners manual before you begin the installation of this body lift kit.

## ⚠CAUTION

Proper installation of a Performance Accessories body lift kit requires knowledge of the factory recommended procedures for disassembly and assembly of original equipment components. We recommend that the factory shop manual and any special tools necessary to your vehicle be on hand during the installation. Installation of this body lift kit without proper knowledge of the factory recommended procedures may affect the performance of these components and the safety of your vehicle. We strongly recommend that a certified mechanic familiar with the installation of similar components install this body lift kit.

## ⚠WARNING

This body lift kit should only be installed on vehicles in good working condition. Before installation, the vehicle should be thoroughly inspected for evidence of corrosion or deformation of the sheet metal around the factory body mounts. This body lift kit should not be installed on any vehicle that is suspected to have been in a collision or misused. Off road use of your vehicle with this body lift installed may increase the stress applied to the factory body mounts. We do not recommend that any vehicle with a body lift installed be involved in any extreme off road maneuvers such as jumping. Failure to observe this warning may result in serious personal injury and/or severe damage to your vehicle.

## ⚠WARNING

Many states now have laws restricting bumper heights and vehicle lifts. Local laws should be consulted to determine if the changes you intend to make to your vehicle comply with state laws.

## ⚠WARNING

The installation of larger wheel and tire combinations may reduce the effectiveness of the Anti-lock Braking System.

## ⚠WARNING

Always wear eye protection when operating power tools.

## ⚠WARNING

Ensure that your vehicle tires are properly blocked and secured before you begin installation of this lift kit.

## ⚠WARNING

The Supplemental Restraint System (SRS, or air bag) must be deactivated during lift kit installation to avoid accidental air bag deployment while working near SRS sensors and wiring. Do not allow anyone near the air bag during lift kit installation. Accidental deployment can result in serious personal injury or death. Refer to your factory service manual/owner's manual for the recommended procedure to disable the SRS. The SRS must be reactivated before driving the vehicle

## ⚠NOTE

Performance Accessories recommends using the Loctite® supplied in the kit on all hardware unless noted in the instructions.

## ⚠WARNING

DO NOT combine suspension, body, or other lift devices. Use of vehicle with combined lifts may result in unsafe and/or unexpected handling characteristics.

## A. Before you start.

### ⚠NOTE

As you read through this procedure, note that each part referenced has the same callout number throughout. Also, the part number in the text matches the corresponding part number in the art. Kit parts are prefaced by the word *kit* in italics.

### ⚠NOTE

You will find it easier to keep track of hardware if immediately after removal you put the fasteners for each subassembly in a paper lunch bag and write on the bag where they go.

1. Read all warnings and instructions completely and carefully before you begin.
2. Check to make sure the kit is complete (refer to the Parts List, section E).
3. Only install this kit on the vehicle for which it is intended. If anytime during the installation you encounter something different from what is outlined in the instructions, call technical support at (928) 636-7080.
4. Park the vehicle on a clean, dry, flat, level surface and block the tires so the vehicle cannot roll in either direction.
5. Disconnect both battery cables. Disconnect the negative cable (1) first, then the positive cable (2) from the battery (3).

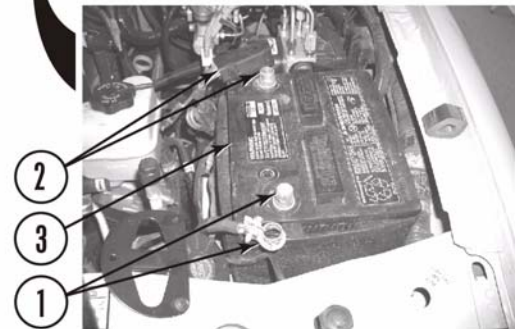

6. Remove cover (4) and the airbag fuse #26 (5) from the fuse panel (6).

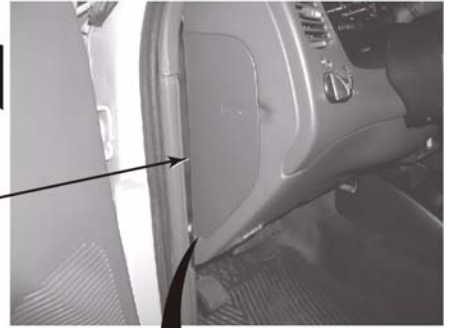

4

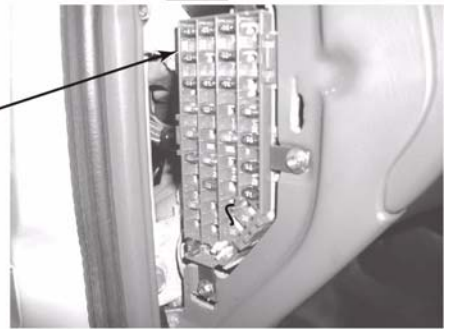

5

6

**B. Get ready to install the kit.**

1. Remove the front bumper.
  - a. Measure distance between front bumper (7) and left and right front fenders (8 and 9).

Driver Side \_\_\_\_\_ Passenger Side \_\_\_\_\_

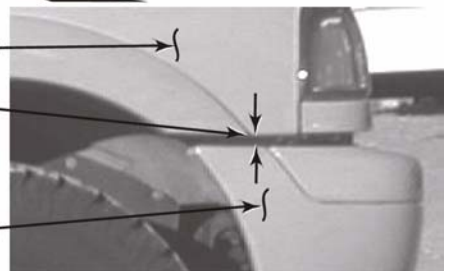

8 9

MEASURE

7

- b. If so equipped, remove two connectors (10) from fog lamps (11).
- c. Remove push clip (12) and wire harness (13) from front bumper (7).

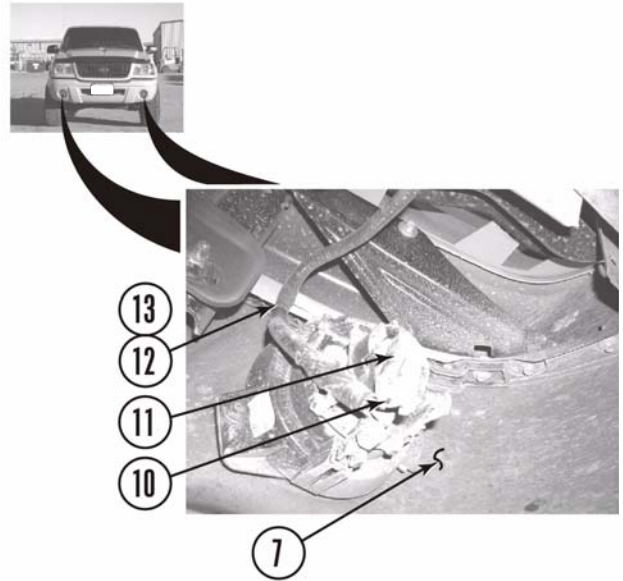

- d. Remove four nuts (14) and front bumper (7) from frame (15).

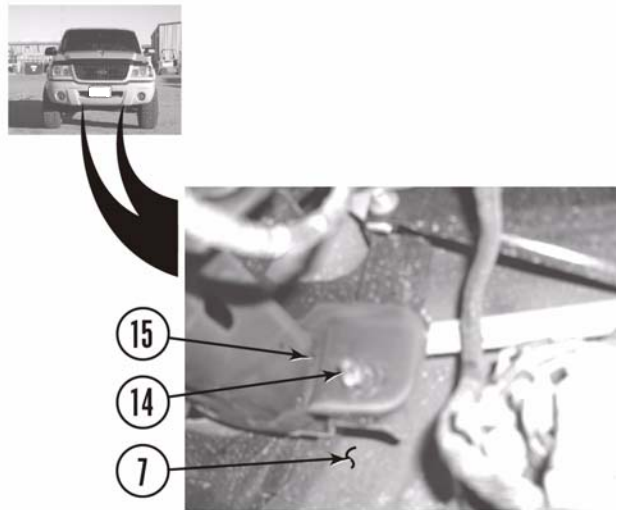

- e. Remove six bolts (16) and two tow hooks (17) from frame (15).

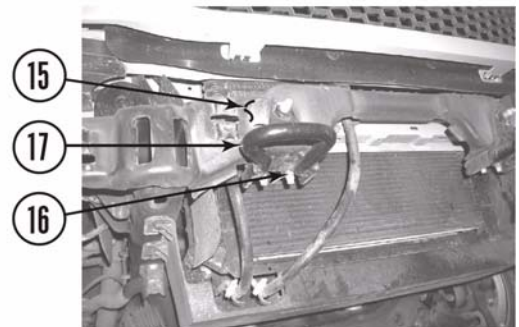

- f. Remove four screws (18) and skid plate (19) from frame (15).



2. Transmission cooler models:

- a. Remove three bolts and transmission cooler brackets from core support.

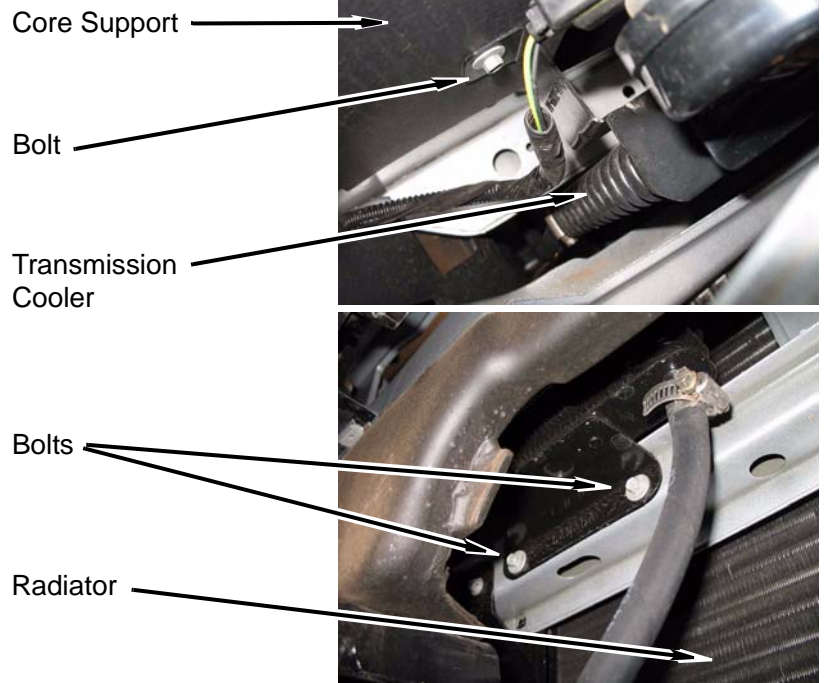

3. Under the hood.

Fuel injection.

- a. Remove three bolts (20) and fuel injection cover (21) from throttle body (22).

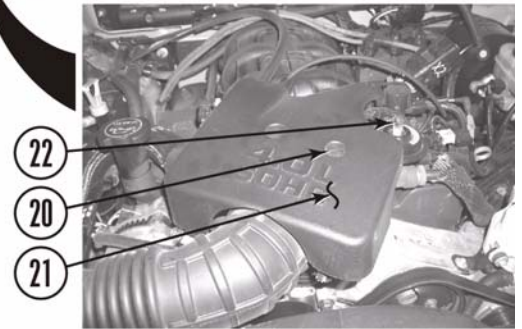

- b. Loosen two clamps (23) and remove air intake duct (24) from throttle body (22), PVC pipe (25), and air filter housing (26). Leave harness (27) connected and move air intake duct out of way.

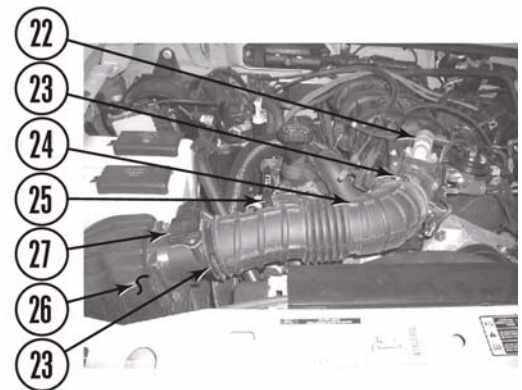

- 4. If so equipped, remove screw (29) and alarm siren (30) from core support (31).

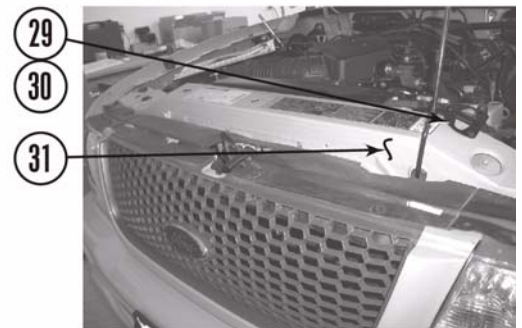

Radiator.

- a. Remove two bolts with captive washers (32) and radiator (33) from core support (31). Lift radiator up and off lower mounting pads (34). Radiator will be lowered later.

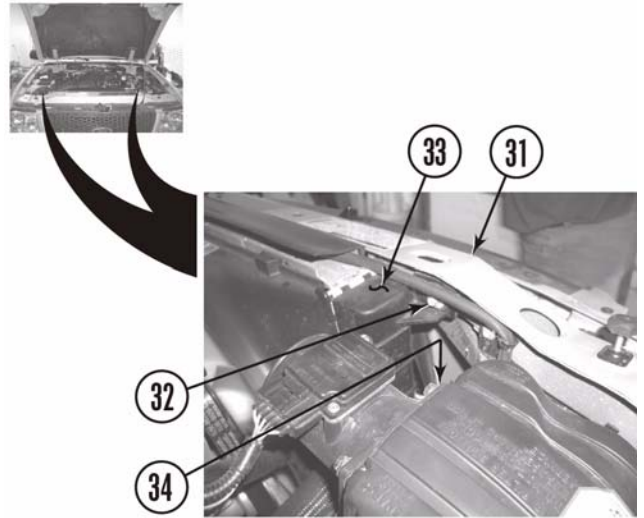

Battery cables.

- b. Remove negative cable (1) clip from battery tray (35).
- c. Remove positive cable (2) clip from battery tray (35).

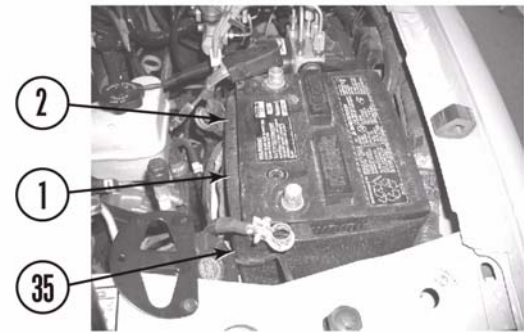

- d. Remove harness (36) clip from back of a/c compressor (37).

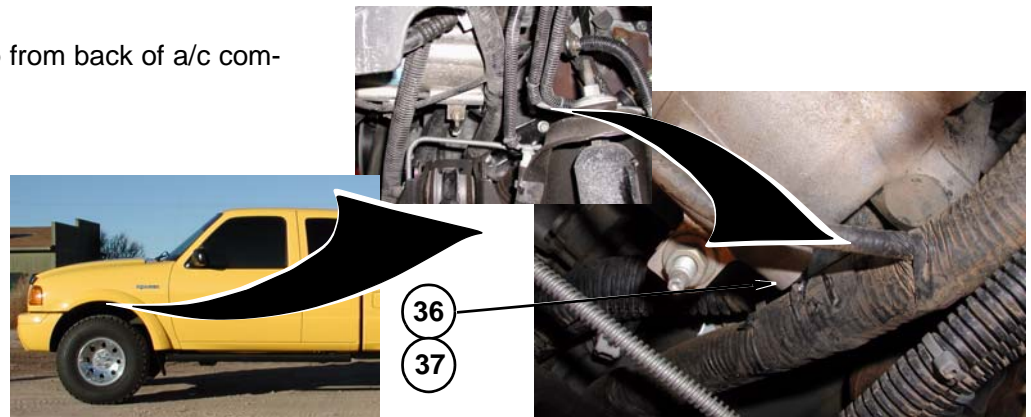

- e. Remove bolt (38), bracket (39), and harness (36) from engine block (40).

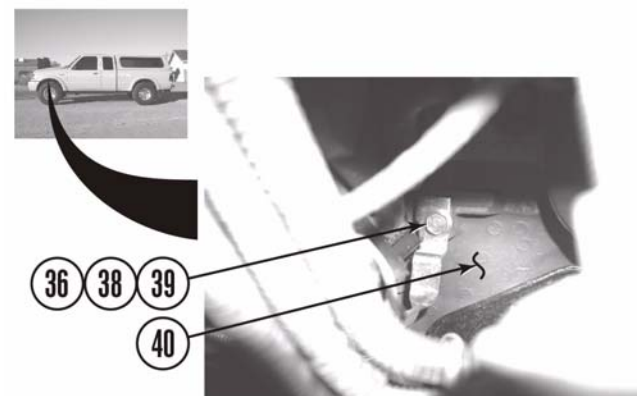

5. Remove nut (41) and ground strap (42) from stud (43) on firewall (44).

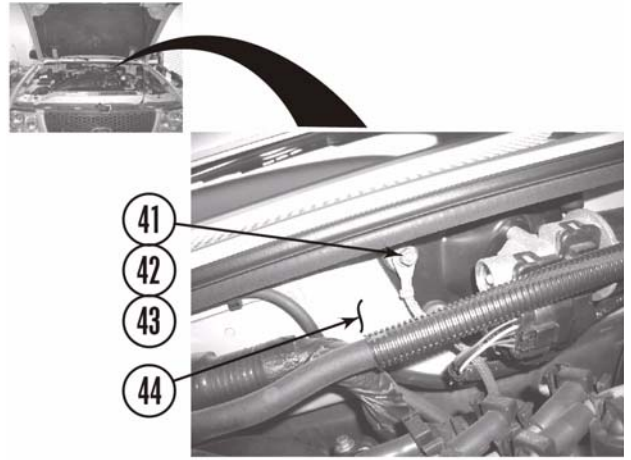

Steering.

- a. Remove bolt (45) and upper steering shaft (46) from lower steering shaft (47).

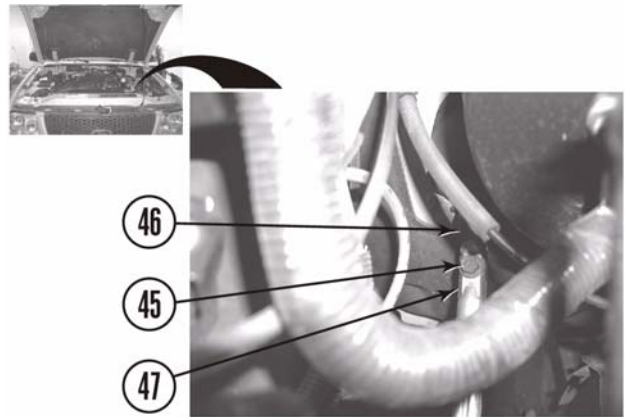

Brake and fuel lines.

- b. Remove clip (48) from three ABS lines (49, 50, and 51).

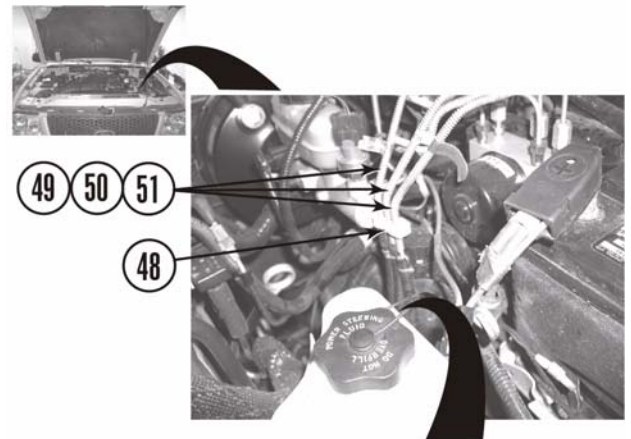

- c. Remove three ABS lines (49, 50, and 51) from clip (52) on driver side shock tower (53).





- d. If so equipped, remove two ABS lines (49 and 50) from two clips (54 and 55) on driver side shock tower (53).

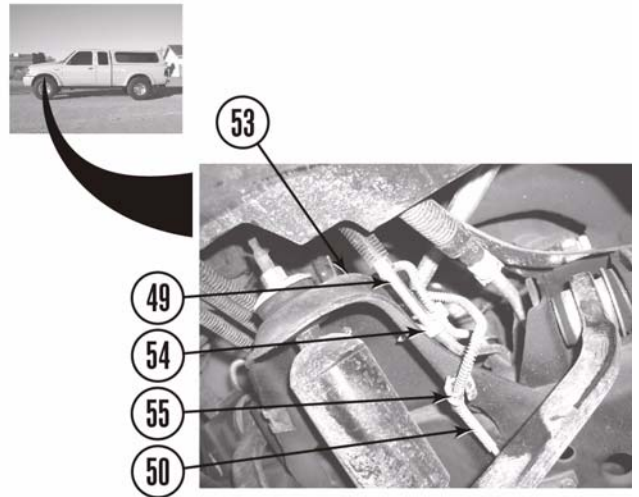

- e. Remove four screws (56) and cover (57) from inside frame rail (15) driver side.

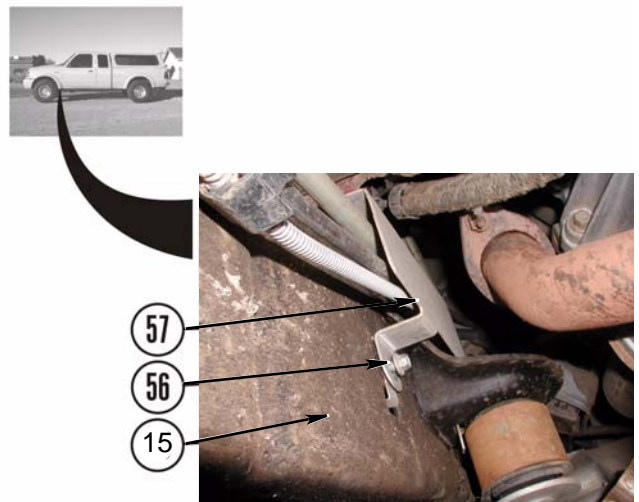

- f. Remove large top line (58) from two clips (59) on frame (15) driver side.

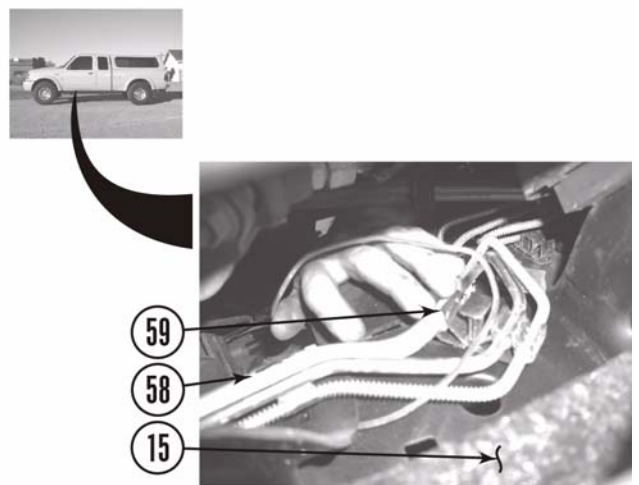

Auto transmission.

**NOTE**

Step g. is for automatic transmission models only. Other models skip this step.

- g. Remove shift cable loop (60) and shift cable (61) from firewall (44).

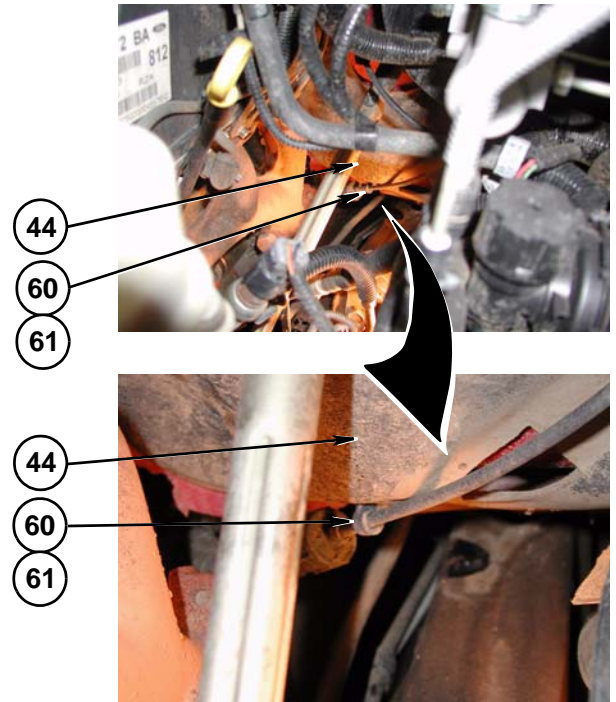

6. Under the cab/along the frame rails.

Parking brake.

- a. Pull some slack in front parking brake cable (62) and clamp cable with a vice grip.
- b. Press locking tab and separate front part of parking brake cable (62) from rear parking brake cable (63).
- c. Remove front part of parking brake cable (62) from driver side frame mounting pad (64).

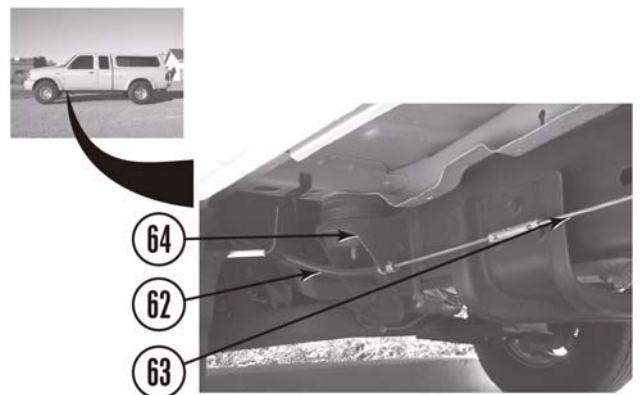

- d. Remove two bolts (65) and two ground straps (66) from frame (15) driver side and passenger side (some trucks have only one ground strap).

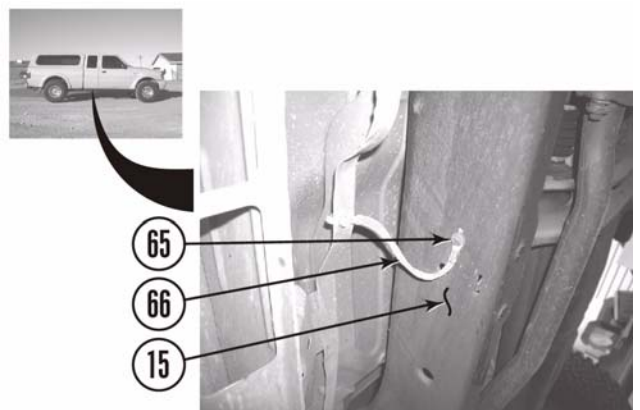

**⚠NOTE**

Step 6 is for automatic transfer case models only. Other models skip this step.

7. Electronic shift 4WD transfer case.

- a. Remove harness connector (67) from harness (68) on transfer case (69).
- b. Bend tab to release harness (68) from bracket (70).

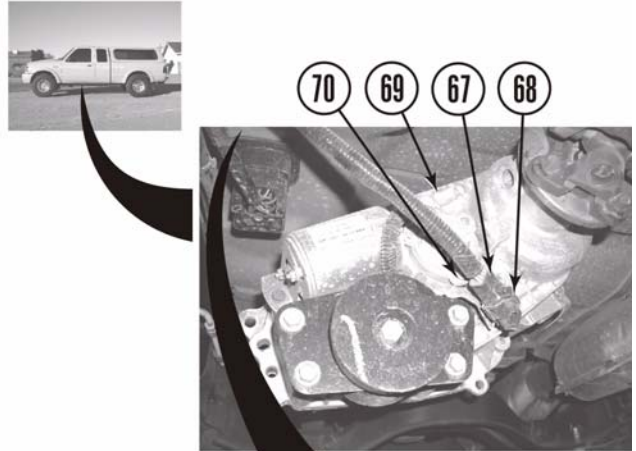

**⚠NOTE**

Be cautious of wiring harness length when lifting cab.

- c. Remove harness (68) clip from frame (15) driver side.



8. Inside the cab.

- a. Remove two scuff plates (71) from cab floor (72).

**⚠CAUTION**

Be careful not to damage the plastic tabs that mount the kick panels to the cab.

- b. Lift and remove two kick panels (73) from cab (74).



- c. Pull carpet (75) away and remove two rubber caps (76) from front of cab floor (72).

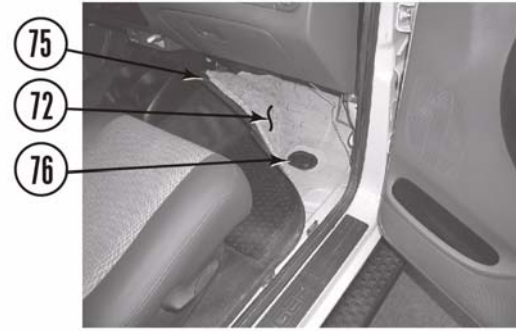

- d. Fold up rear seats (77) and remove two push clips (78) and covers (79) from cab floor (72).

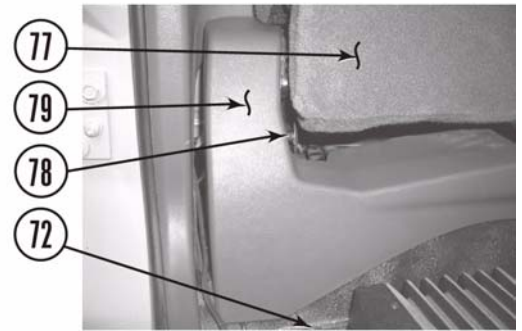

- e. Remove eight bolts (80), four torx bolts (81), and two rear seats (77) from cab floor (72).



- f. Remove two rubber caps (76) from cab floor (72).



## 9. Manual transmission.

### △NOTE

Step 8. is for manual transmission vehicles only. Manual transmission vehicles require a shift extension, part #3700, sold separately. Other models skip these steps.

- a. Remove four screws (82) and transmission shift console (83) from mounting flange (84). Pull boot (85) up and out of way.
- b. Remove nut (86) from right side of wedge stud (87). Install on left side of wedge stud and tighten to remove stud.
- c. Remove upper shift lever (88) from lower shift lever (89).

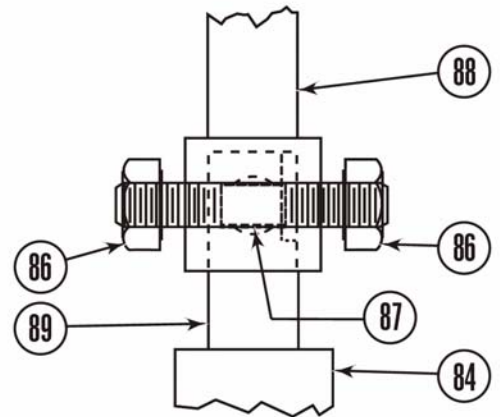
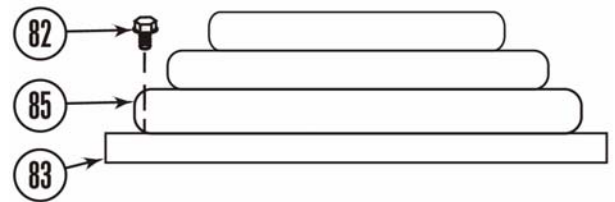

- d. Start *kit* roll pin (90) in *kit* extension (91).
- e. Install *kit* 5/16" nylock nut (92) on *kit* 5/16" x 1" bolt (93) with nylon toward head of bolt. Start bolt in *kit* extension (91).
- f. Position *kit* extension (91) on lower shift lever (89), align *kit* roll pin (85) with hole in lower shift lever, and fully install roll pin.
- g. Tighten *kit* 5/16" x 1" bolt (93) in lower shift lever (89). When bolt bottoms out, tighten *kit* nylock nut (92) against *kit* shift extension (91).
- h. Position upper shift lever (88) on *kit* extension (91) and install wedge stud (87) through slot in *kit* extension (91) and install nut (92).
- i. Position boot (85) on mounting flange (84) and install transmission shift console (83) with four screws (82).

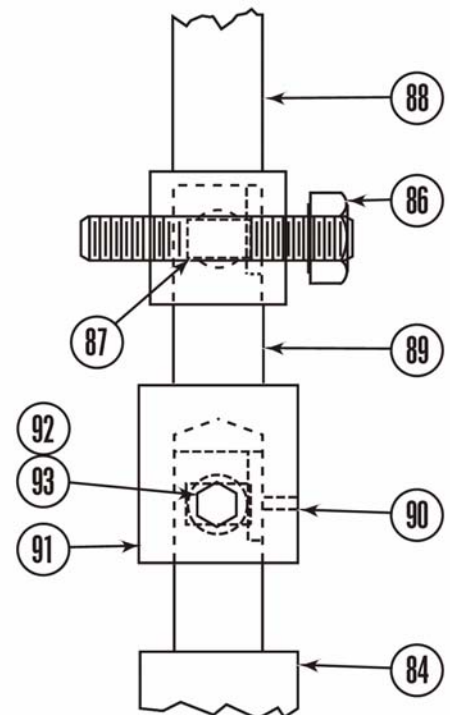
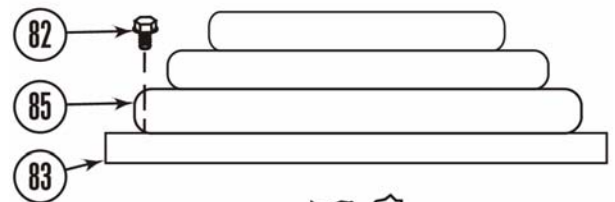

**⚠WARNING**

Use extreme caution when working near fuel lines and fuel tank. Clean up spilled fuel immediately. Any spark could cause an explosion or fire resulting in serious personal injury and property damage.

10. Remove the fuel filler.

- a. Remove gas cap (94).
- b. Remove three bolts (95) and fuel filler (96) from bed (97).

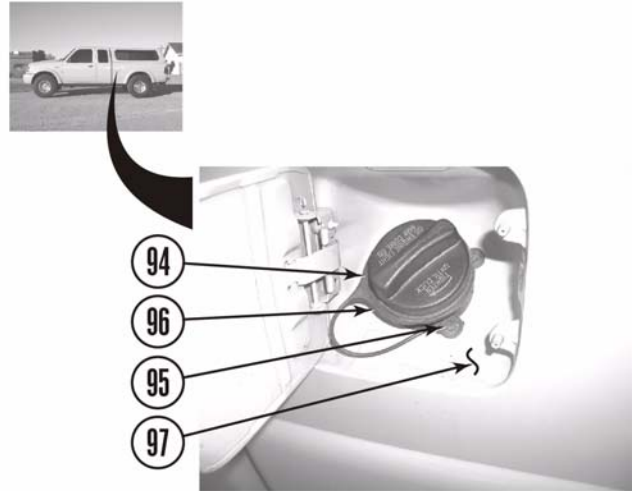

11. Rear bumper.

- a. Measure distance between tailgate (98) and rear bumper (99).

Driver Side \_\_\_\_\_ Passenger Side \_\_\_\_\_

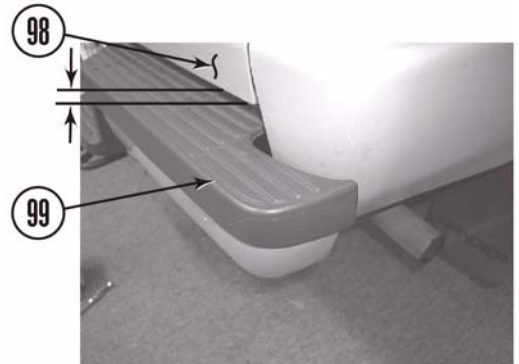

- b. If so equipped, disconnect trailer hitch connector (100) from rear bumper (99).
- c. Remove two license plate lights (101) from rear bumper (99).

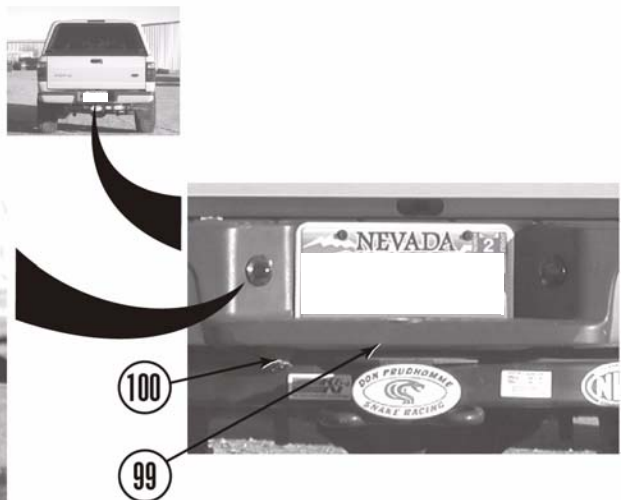
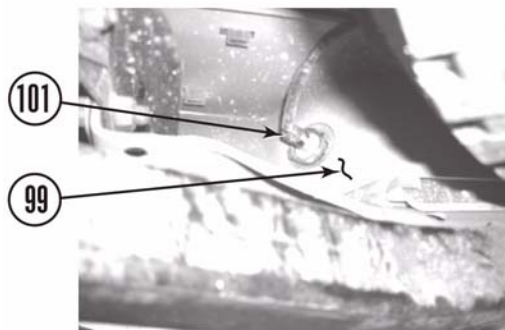

- d. Remove four bolts (102) from clip nuts (103). Remove two rear bumper brackets (104) and rear bumper (99) from frame (15).

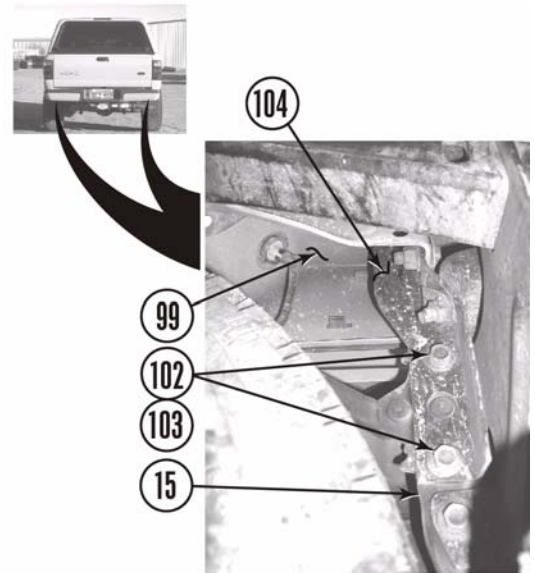

- e. Remove connector (105) and harness (106) from bed (97).

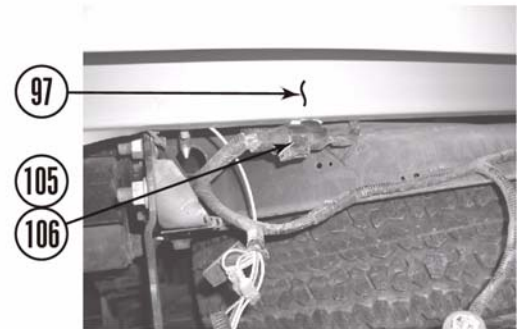

- f. Loosen two screws (107). Remove two bolts (108), nuts with captive brace (109), and outside rear bumper brackets (110) from rear bumper brackets (104).
- g. Remove four nuts (102), two double stud fasteners (111), and two rear bumper brackets (104) from rear bumper (99).

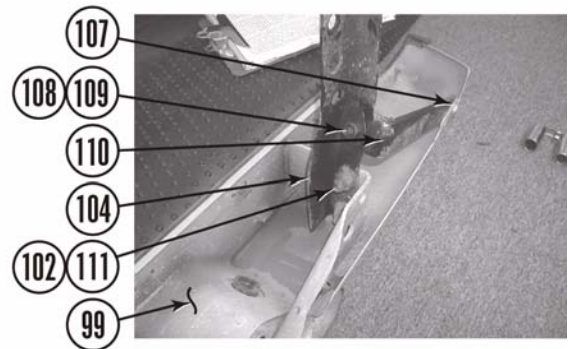

## C. Install the kit.

Cab.

1. Prepare to lift cab from frame.

### ⚠WARNING

Failure to replace the OEM body mounting hardware (except mounting bolts in the kit) in the stock locations could result in serious personal injury or damage to the vehicle.

- a. Measure distance between the cab (74) and the bed (97). Record measurement for later cab to bed alignment reference in these instructions

Driver Side \_\_\_\_\_ Passenger Side \_\_\_\_\_.

### ⚠NOTE

Ford uses an extremely cohesive thread locker on cab and bed mounting bolts. This is no problem on the bed and core support mounting points, but the four cab mounting bolts screw into the lower bushings and with the thread locker these are difficult to remove. You will need a friend with a big pair of channel locks to hold the lower bushings while you unscrew the cab mounting bolts. You will encounter much resistance from the thread locker the whole time you are turning the bolts, and air tools really don't work well on this application.

- b. Hold nuts (112) and loosen but do not remove two cab mounting bolts (113) from core support (31) and frame mounting pads (64).
- c. Hold bottom bushings (114 & 171) and loosen but do not remove four cab mounting bolts with captive washers (115).

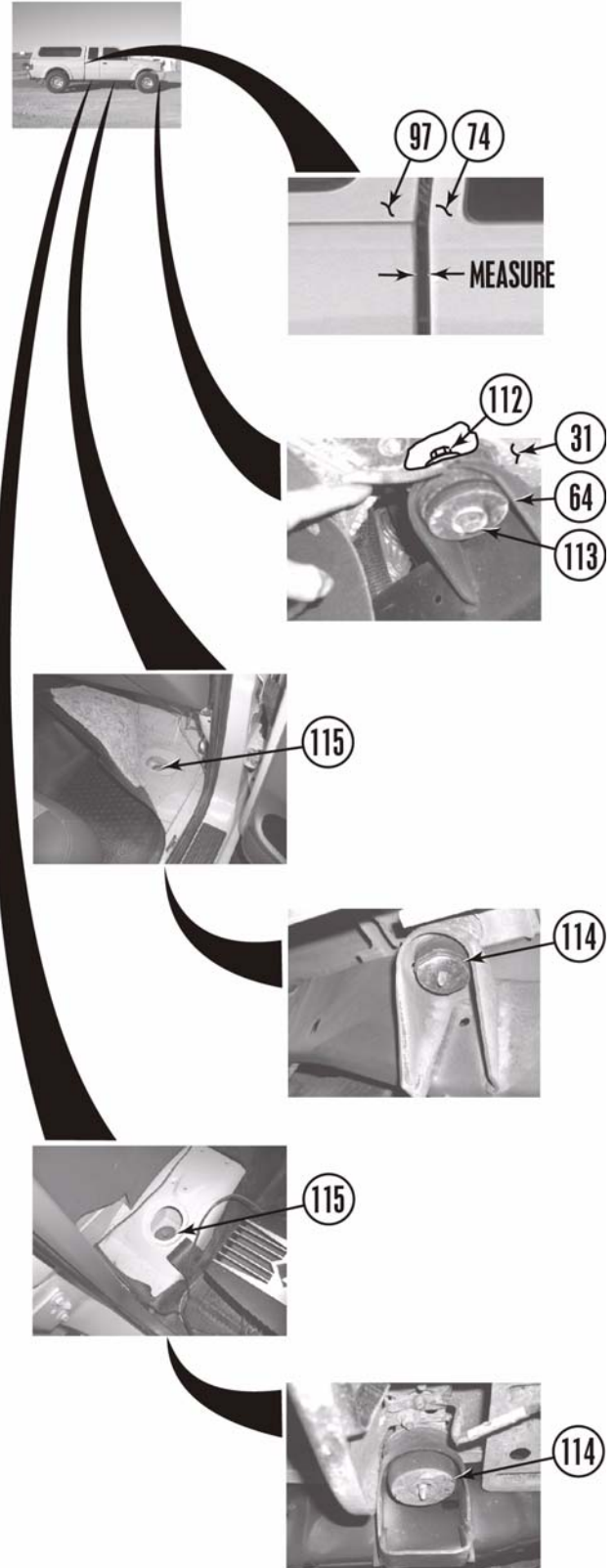



**⚠WARNING**

Use extreme caution when lifting body from frame. Ensure lifting device is securely placed. Keep hands out from between frame and body, or serious personal injury could result.

**⚠CAUTION**

Continually check hoses, wires, lines, etc. to be sure that everything is flexing properly and not binding, or damage to the vehicle could result. **Be especially careful of the ABS lines on top of the driver side wheel well. Bending the lines a little at a time while lifting will be necessary. Be extremely careful not to kink the lines.**

**⚠NOTE**

Ensure stock spacers and body mounting pads stay on vehicle unless otherwise specified in these instructions. *Kit* spacer blocks are installed in addition to the stock spacers and body mounting pads.

- d. Remove cab mounting bolt (113), bottom bushing (171), nut (112), and washer (116) from the passenger side core support (31) and passenger side frame mounting pad (64).
- e. Remove cab mounting bolt with captive washer (115), washer (117), and bottom bushing (114) from the front passenger side frame mounting pad (64) and cab (74).
- f. Remove cab mounting bolt with captive washer (115), washer (117), and bottom bushing (114) from rear passenger side frame mounting pad (64) and cab (74).

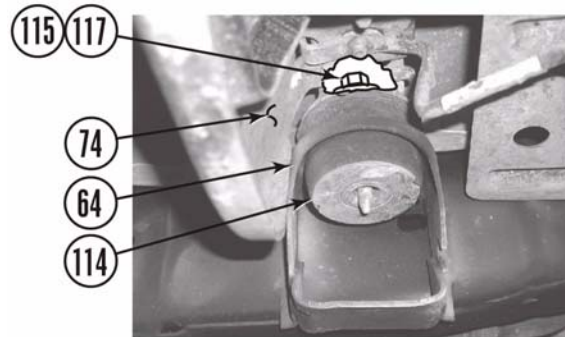
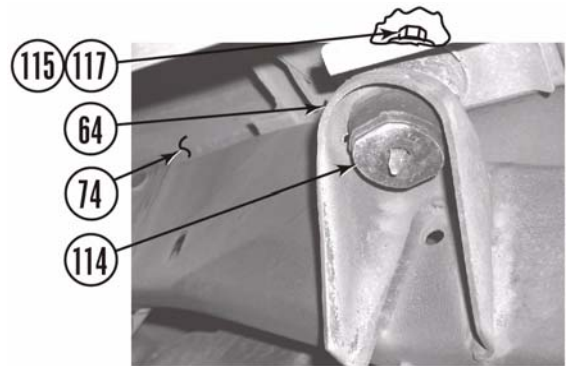
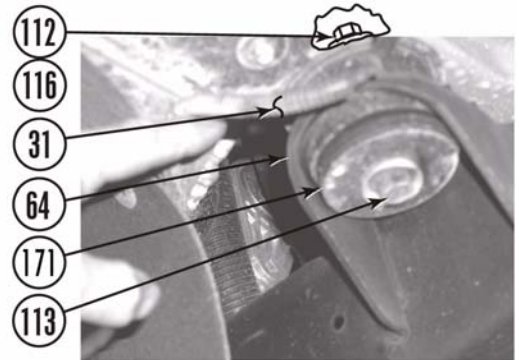

2. Lift cab and install cab passenger side spacer blocks.
  - a. Using a hydraulic jack and a wooden block, slowly lift the cab (74) passenger side just high enough to position the *kit* 3" x 3" spacer blocks (118) between the core support (31) and top bushings (119) on the frame mounting pads (64).



**⚠ CAUTION**

**ONLY DRILL OUT FRONT CORE SUPPORT UPPER AND LOWER BUSHINGS** as directed in the following procedure. Core support mounts are forward most cab mounts. Drilling any other cab mount bushings will not allow for proper installation of kit.

- b. Remove the core support top bushing (170). Using a 1/2" drill bit, drill the threads out of the core support top and bottom bushings (170 & 171) only. Position drilled top bushing back on passenger side core support (31).
- c. Position three *kit* spacer blocks (118) on top of top bushings (119 & 170) on the passenger side frame mounting pads (64).
- d. Install a *kit* 12 x 1.75 x 180mm bolt (120) and *kit* 7/16" USS washer (121) through drilled bottom bushing (171), frame mounting pad (64), drilled top bushing (170), *kit* spacer block (118), cab passenger side core support (31), washer (116), and nut (112). Do not tighten.
- e. Install a *kit* 12 x 1.75 x 140mm bolt (122) and *kit* 7/16" USS washer (121), and washer (117) through the cab floor (72), *kit* spacer block (118), top bushing (119), frame mounting pad (64), and bottom bushing (114). Do not tighten.
- f. Install a *kit* 12 x 1.75 x 160mm bolt (123) and *kit* 7/16" USS washer (121), and washer (117) through the cab floor (72), *kit* spacer block (118), top bushing (119), frame mounting pad (64), and bottom bushing (114). Do not tighten.
- g. Lower cab (67) on the *kit* spacer blocks (118).

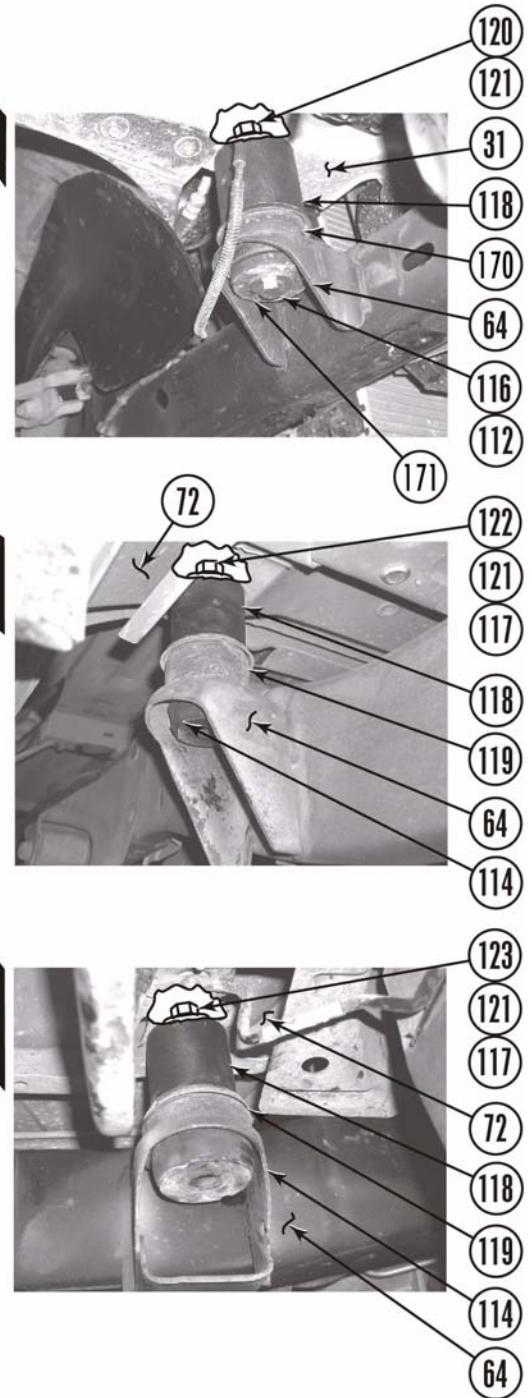

3. Install the cab driver's side spacer blocks.
  - a. Repeat steps C. 1. d. through f. and C. 2. a. through g. for the cab driver's side.
4. Finish the cab spacer block installation.
  - a. Adjust cab to bed clearance using the measurements from step C. 1. a.
  - b. Remove six bolts (120, 122, and 123) one at a time, coat threads with Loctite®, and install. Tighten to 55 lb-ft.

Bed.

**NOTE**

You need a T-55 Torx head socket to remove the bed mounting bolts.

- a. Loosen but do not remove eight bed mounting bolts with captive washers (124) (ten on long bed models) from frame mounting pads (64) and the bed (97).
- b. Remove four bed mounting bolts with captive washers (124) (six on long bed models) from frame mounting pads (67) and the bed (97) passenger's side.

5. Install the bed passenger's side spacer blocks.

- a. Lift the bed (97) passenger's side just high enough to position four *kit* 3" x 3" spacer blocks (118) (six on long bed models) on the frame mounting pads (64).
- b. Lower the bed (97) onto the spacer blocks (118).
- c. Install *kit* 1 3/4" thick washer (125) and *kit* 12mm x 1.75 x 200 mm bolt (126) in the bed (97) front hole, *kit* spacer block (118), and the frame mounting pad (64). Do not tighten.
- d. Install three *kit* 1 3/4" thick washers (125) and *kit* 12mm x 1.75 x 180 mm bolts (127) (four on long bed models) in the bed (97) rear holes, *kit* spacer blocks (118), and the frame mounting pads (64). Do not tighten.

6. Install the bed driver's side spacer blocks.

- a. Repeat steps C. 5 a. through d. for the bed driver's side.

7. Finish the bed spacer block installation.

- a. Adjust the cab to bed clearance using the measurements from step C. 1. a.
- b. Remove eight bed mounting bolts (126 and 127) (ten on long bed models) one at a time, coat threads with Loctite®, and reinstall. Tighten to 55 lb-ft.

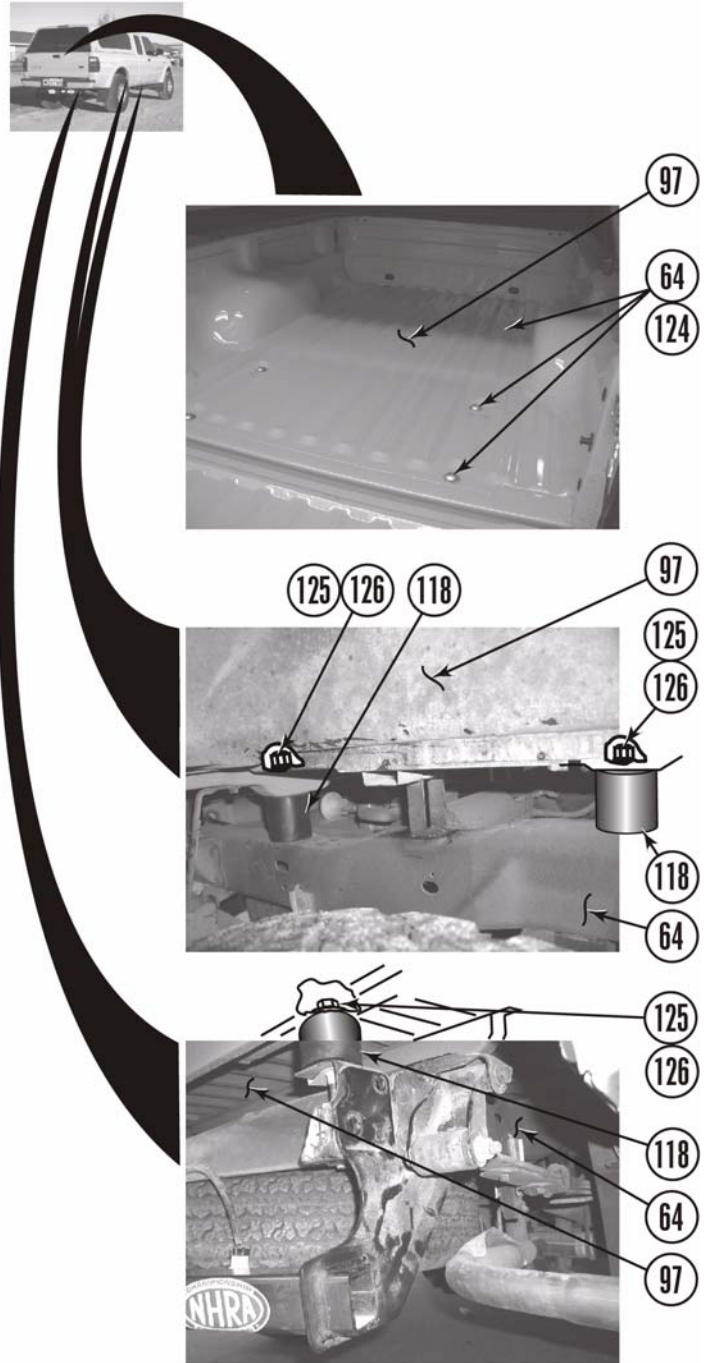

**⚠WARNING**

Use extreme caution when working near fuel lines and fuel tank. Clean up spilled fuel immediately. Any spark could cause an explosion or fire resulting in serious personal injury and property damage.

**8. 1-1/4" Diameter:** Install fuel filler.

a. Cut filler hose (128) and vent hose (129) under bed (97) as shown and remove cut portion from vehicle.

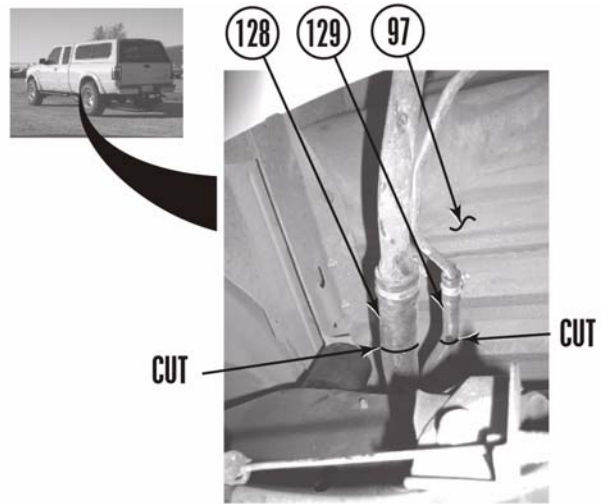

b. Install *kit* filler hose extension (130) on filler hose (128) with *kit* clamp (131).

c. Install *kit* vent hose extension (132) on vent hose (129) with *kit* clamp (133).

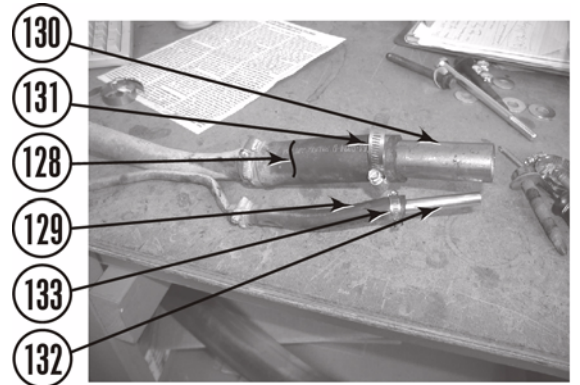

d. Install *kit* vent hose extension (132) and *kit* filler hose extension (130) on cut vent hose (129) and cut filler hose (128) under vehicle with two clamps (131 and 133). Ensure fuel filler will mount correctly on bed and tighten clamps.

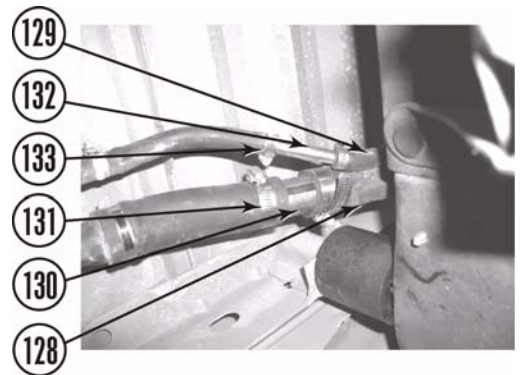

e. Install fuel filler (96) on bed (97) with three bolts (95).

f. Install fuel cap (94).

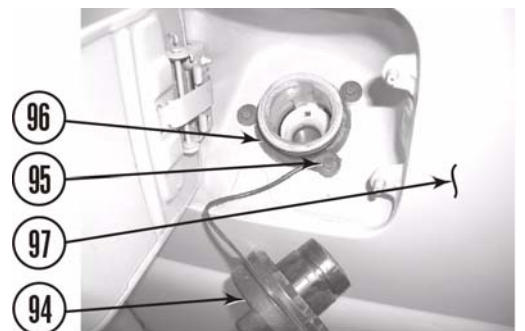

9. **1-1/8" Diameter:** Install fuel filler

- a. Remove two clamps and vent line from fuel filler and fuel tank.
- b. Mark and cut fuel filler hose as shown.

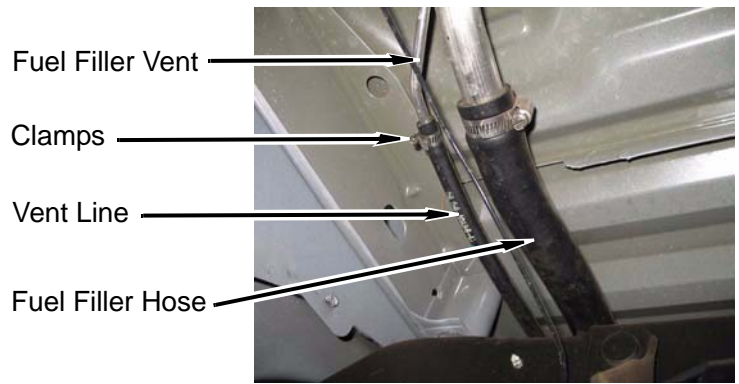

- c. Install kit extension (1-1/8" x 5") between two sections of cut fuel filler hose with two kit clamps (#28). DO NOT TIGHTEN.

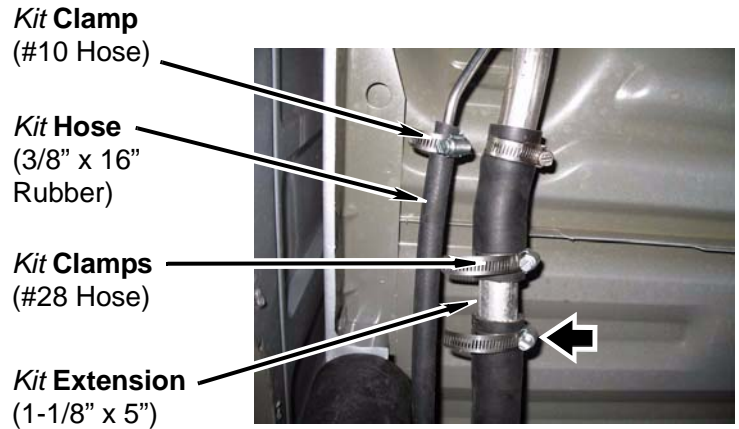

- d. Install fuel filler (96) on bed (97) with three bolts (95).

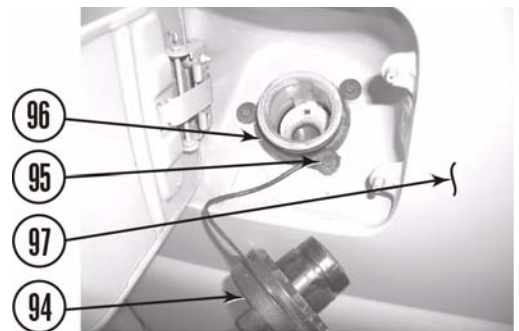

- e. Install kit hose (1/4" x 16") onto fuel filler vent and fuel tank with two kit clamps (#10). DO NOT TIGHTEN.
- f. Adjust fuel filler hose and TIGHTEN kit clamps. Install fuel cap.

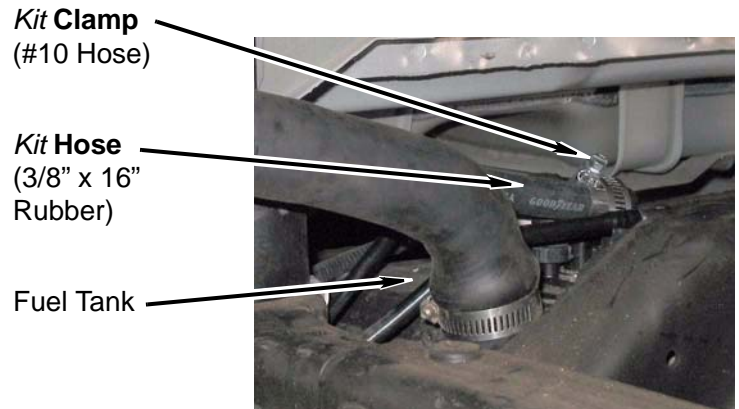

10. Inside the cab.

- a. Install two rubber caps (76) on cab floor (72).



- b. Install two rear seats (77) on cab floor (72) with eight bolts (80) and four torx bolts (81).

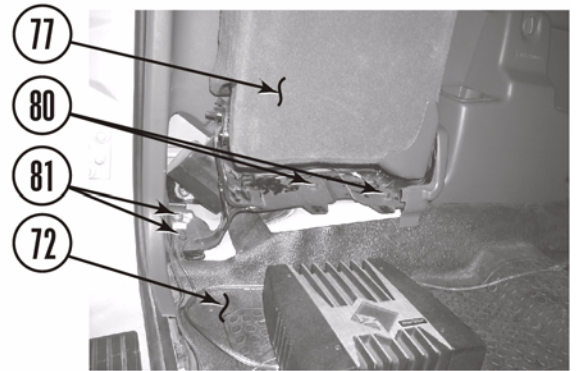

- c. Install two covers (79) on cab floor (72) with two push clips (78).

- d. Fold rear seats (77) back their original position.

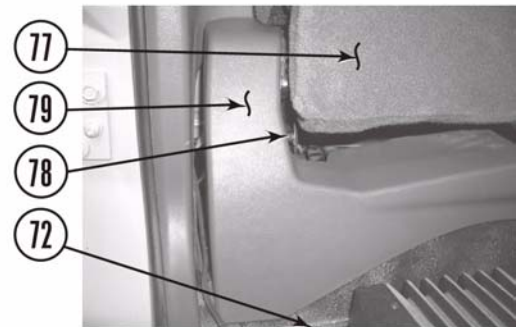

- e. Install two rubber caps (76) in front of cab floor (74).



- f. Smooth carpet (75) to it's original position and install two kick panels (73) and two scuff plates (71) on cab floor (72).



11. Under the cab.

- a. Remove bolt (134) and washer (135) from bracket (70).

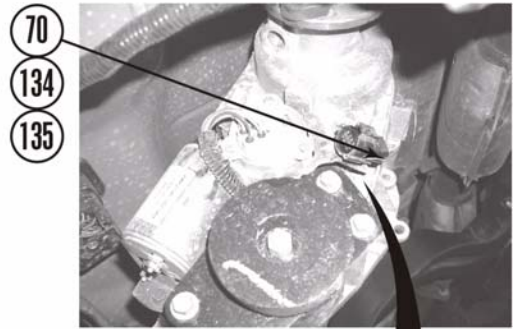

- b. Position *kit* harness clamp (136) around harness (68) and install harness clamp on bracket (70) with washer (134) and bolt (135).

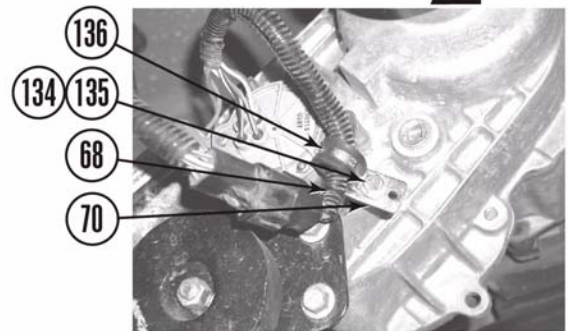

- c. If possible, install harness (68) clip on frame (15) driver side.

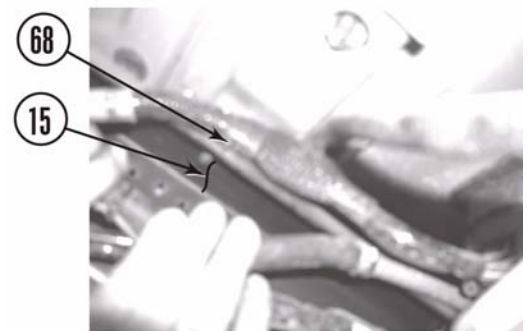

## Auto transmission.

- d. If possible, install shift cable loop (60) and shift cable (61) on firewall (44).



## 12. Along the frame rails.

- a. Install two *kit* ground strap brackets (137) on frame (15) driver side and passenger side with two bolts (65) (some trucks only have one ground strap).
- b. Install two ground straps (66) on *kit* ground strap brackets (137) with two *kit* 1/4" x 1" bolts (138), four *kit* 1/4" SAE washers (139), and two *kit* 1/4" nylock nuts (140).

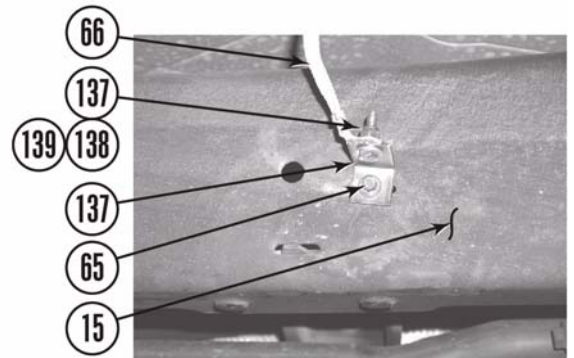

## 13. Parking brake.

- a. Using *kit* parking brake bracket (141) as a template, drill two 5/16" holes on frame driver side mounting pad (64) as shown.
- b. Install *kit* parking brake bracket (141) on frame driver side mounting pad (64) with two *kit* 5/16" x 1" bolts (142), four *kit* 5/16" USS washers (143), and two *kit* 5/16" nylock nuts (144).
- c. Route front parking brake cable (62) through the biggest hole in the *kit* parking brake bracket (141) as shown.
- d. Pull some slack in front parking brake cable (62) and clamp cable with a vice grip.
- e. Reconnect the front cable (62) to the rear cable (63) and press in locking tab.

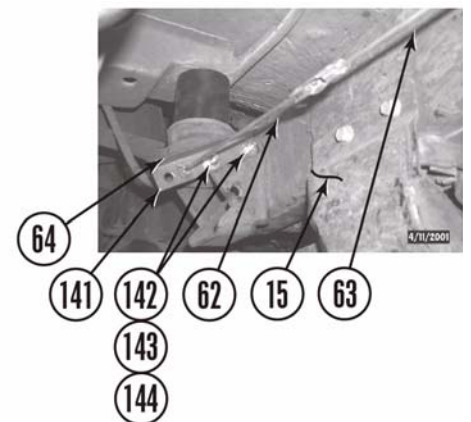



14. Under the hood.

Brake and fuel lines.

- a. If possible, install large top line (58) in two clips (59) on frame (15) driver side.

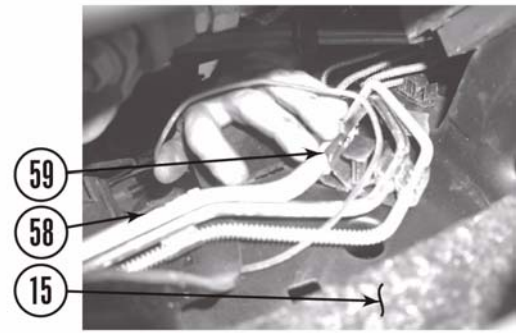

- b. If possible, install cover (57) on frame (15) driver side with four screws (56). It may be necessary to trim cover to install.

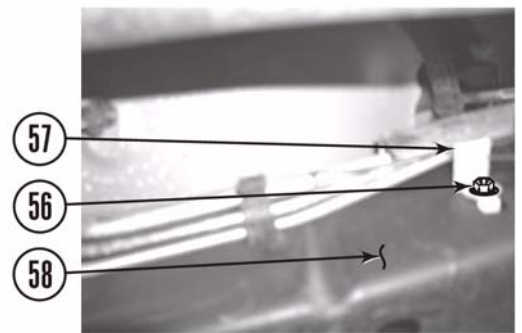

- c. If possible, install two ABS lines (49 and 50) in clips (54 and 55) on driver side shock tower (53).



- d. If possible, install three ABS lines (49, 50 and 51) in clip (52) on driver side shock tower (53).



- e. If possible, install clip (48) on three ABS lines (49, 50 and 51).

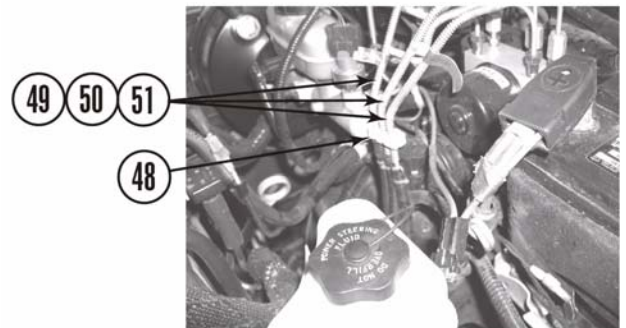

- f. Install *kit* short stud bracket (145) on stud (43) with nut (41).
- g. Install ground strap (42) on *kit* short stud bracket (145) stud with *kit* 1/4" SAE washer (138) and *kit* 1/4" nylock nut (140).

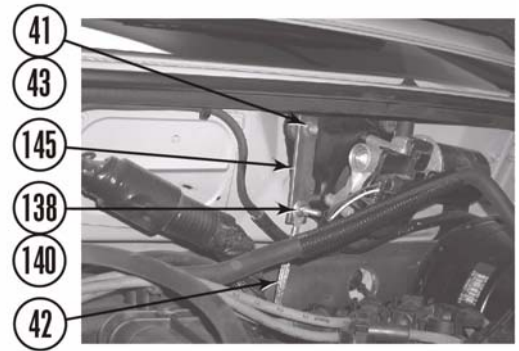

Steering extension.

**⚠ WARNING**  
 Verify the steering extension is securely installed as specified in the instructions. Failure to do so may cause steering malfunction, resulting in property damage or serious personal injury.

- h. Position *kit* steering extension (146) on upper steering shaft (46) and install *kit* 3/8" x 1 1/2" bolt (147), two *kit* 3/8" SAE washers (148), and *kit* 3/8" nylock nut (149).
- i. Slide lower steering shaft up onto *kit* steering extension (47) and tighten bolt (45).
- j. Tighten bolts (45 and 147) to 33 lb-ft.

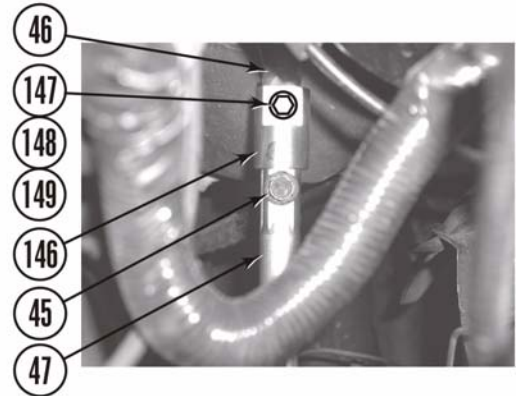

Battery cables.

- k. If possible, install bracket (39) and harness (36) on engine block (40) with bolt (38).
- l. If possible, install harness (36) clip on back of a/c compressor (37).

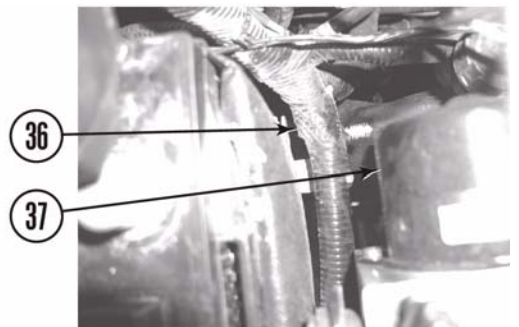
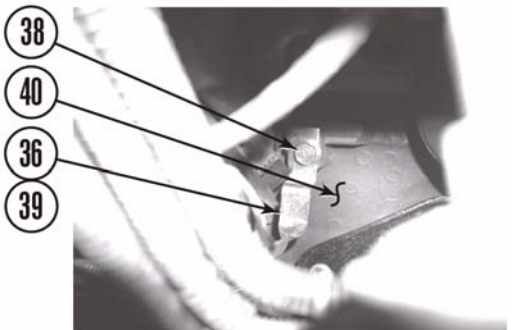

- m. If possible, install positive cable (2) clip in battery tray (35).
- n. If possible, install negative cable (1) clip in battery tray (35).

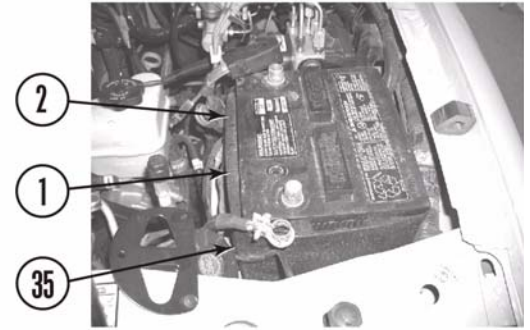

Radiator.

**⚠NOTE**  
 You may wish to drain radiator at this point if radiator will be easier for you to handle.

- o. Install two *kit* long stud radiator brackets (150) on core support (31) with two bolts with captive washers (32). Do not tighten.
- p. Install radiator (33) on two *kit* long stud radiator brackets (150) with two *kit* 1/4" SAE washers (139) and *kit* 1/4" nylock nuts (140). Do not tighten.



**⚠NOTE**  
 The metal seams of the core support may not be tack welded flush. It may be necessary to file the inside edges of the top core support section until it matches the lower core support section in order to properly mount the fan shroud mounting brackets.

- q. Remove two rubber bushings (151) from lower mounting pads (34).
- r. Install two rubber bushings (151) in *kit* fan shroud mounting brackets (152).
- s. Install two *kit* lower radiator mounting brackets (152) on lower mounting pads (34) with two *kit* 5/16" clip nuts (153) (attached), *kit* 5/16" SAE washers (143) and *kit* 5/16" x 1" bolts (142). Ensure radiator mounting tabs (154) are positioned inside *kit* radiator mounting brackets. Do not tighten.
- t. Check fan to fan shroud clearance. Ensure gap is the same all around shroud and tighten bolts (32 and 142) and nuts (140).

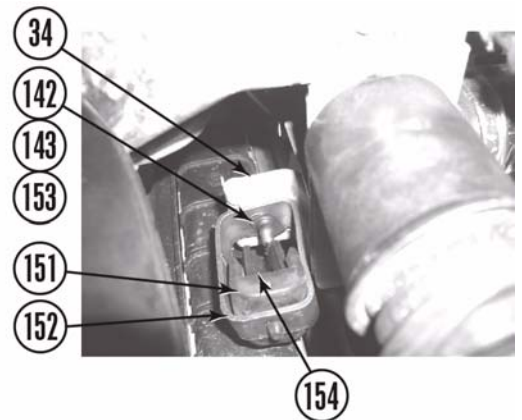

- u. **Transmission cooler models:** Install three *kit* 3" short stud brackets onto core support with three bolts. DO NOT TIGHTEN.

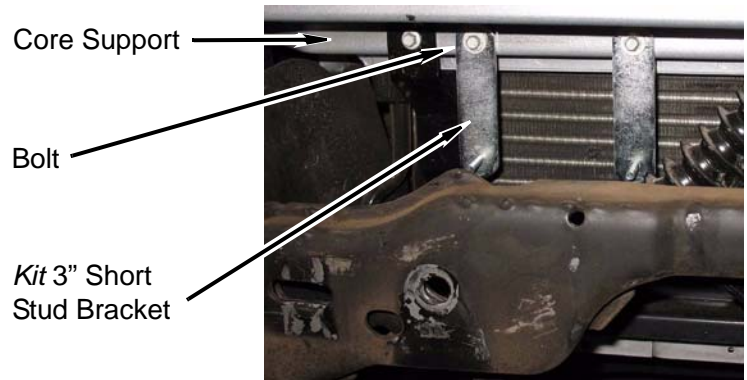
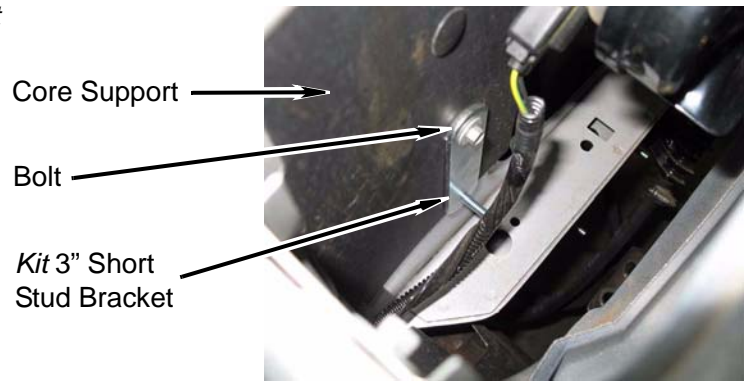

- v. **Transmission cooler models:** Install transmission cooler onto three *kit* 3" short stud brackets with three *kit* 1/4" SAE washers and three *kit* 1/4" nylock nuts. TIGHTEN all hardware.

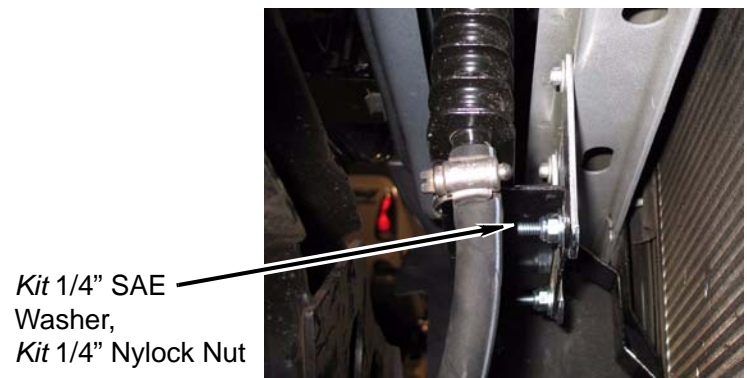
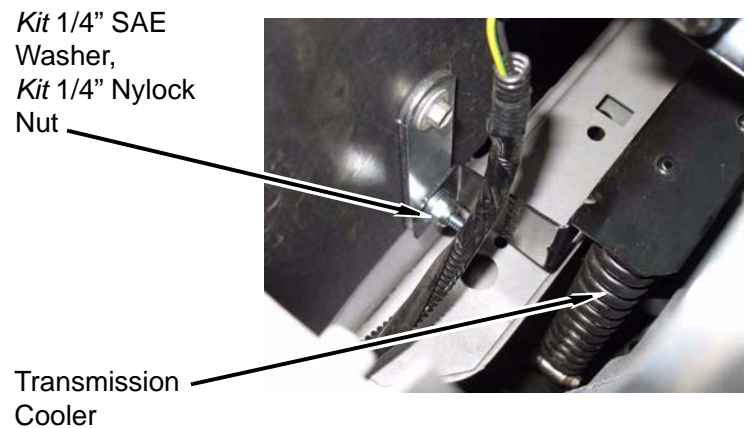

- w. Position *kit* thick metal clamp (155) over a/c line (156) which, since body has been lifted, now contacts fan belt.
- x. Install *kit* thick metal clamp (155) on stud (157) on engine block (40) with *kit* 8mm washer (158) and 8mm nylock nut (159).

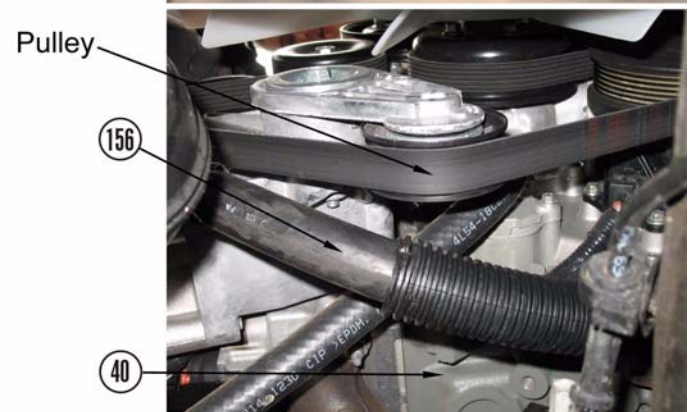
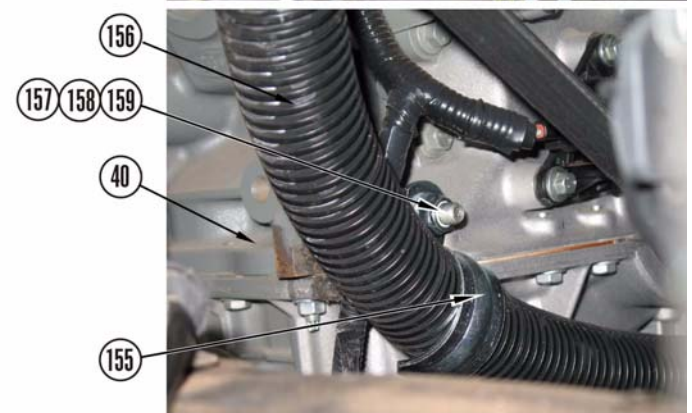
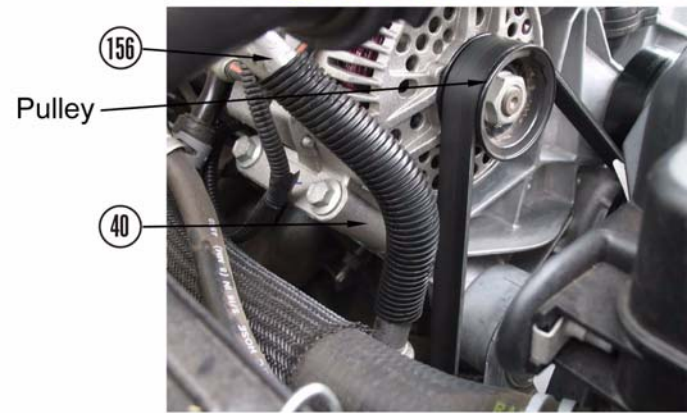

**⚠ CAUTION**

It may be necessary to bend the a/c line near the condenser to allow more space between a/c line and pulleys. Allow 3/4" between a/c line and pulleys for engine movement. Carefully bend a/c lines so that they DO NOT kink or crack. Failure to exercise caution may result in a/c system leaks.

- y. If necessary, squeeze clamp (160) and rotate lower radiator hose (161) to avoid contact with stabilizer bar (162).

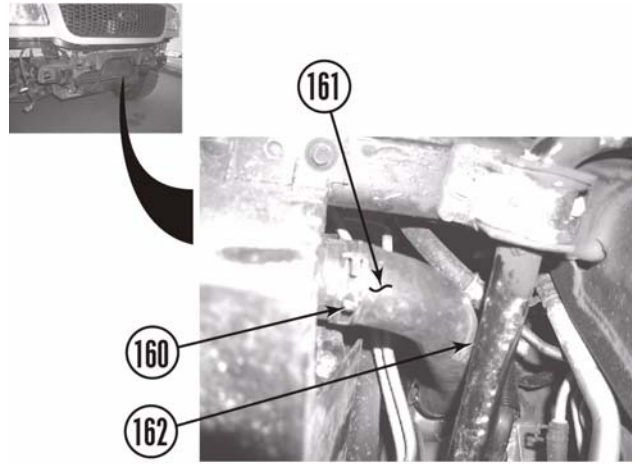

- z. Install skid plate (19) on frame (15) with four screws (18).



- aa. If so equipped, install alarm siren (30) on core support (31) with screw (29).

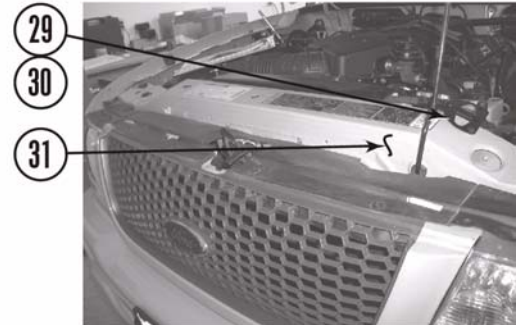

Fuel injection.

- ab. Position air intake duct (24) on air filter housing (26), PVC pipe (25), and throttle body (22) and tighten two clamps (23).

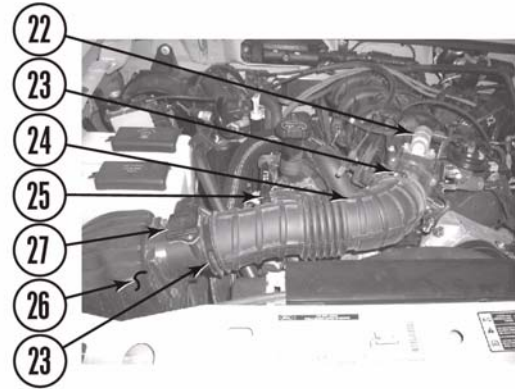

- ac. Install fuel injection cover (21) on throttle body (22) with three bolts (20).

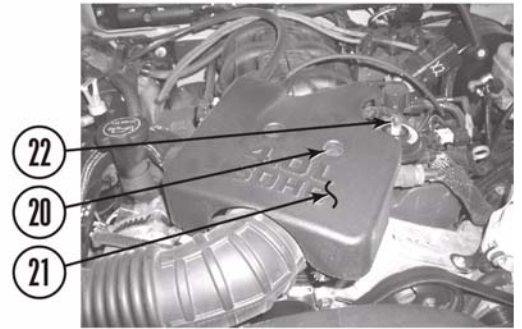

15. Install the front bumper.

- a. Coat threads of nuts (14 and 164) with Loctite®.
- b. Install two *kit* front bumper brackets (163) on frame (15) with four *kit* 1/2" USS washers (121) and four *kit* 1/2" nylock nuts (164). DO NOT TIGHTEN.

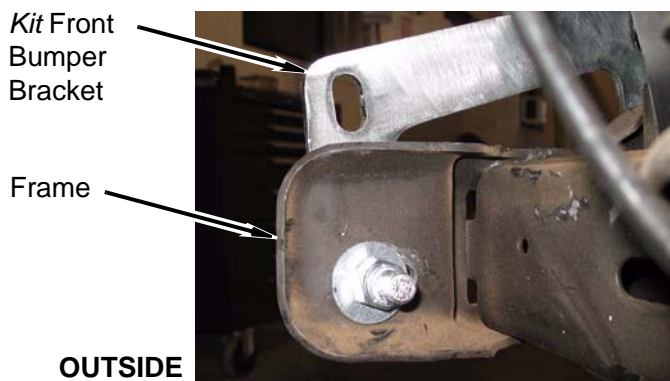
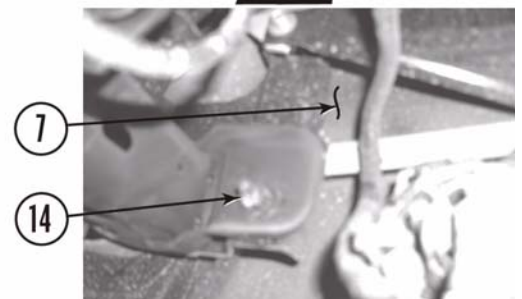
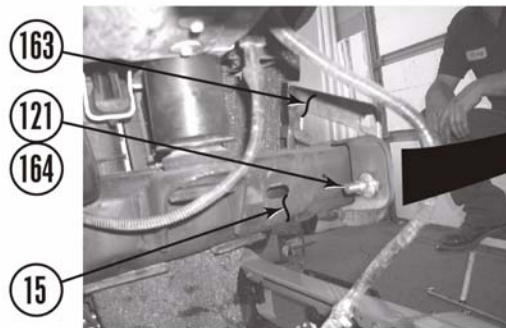
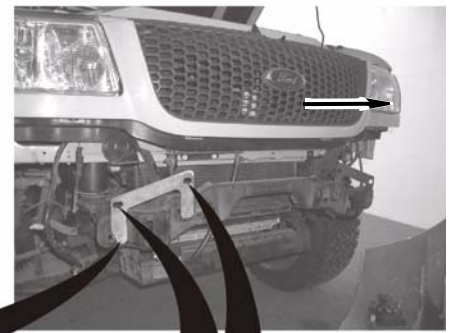

- c. **Fog light models:** Test fit bumper onto two *kit* front bumper brackets (163). It may be necessary to trim outside edges of frame horns for proper clearance.



- d. Install front bumper on *kit* front bumper brackets with four nuts. DO NOT TIGHTEN.

Front  
Bumper

*Kit* Front  
Bumper  
Bracket

Nuts

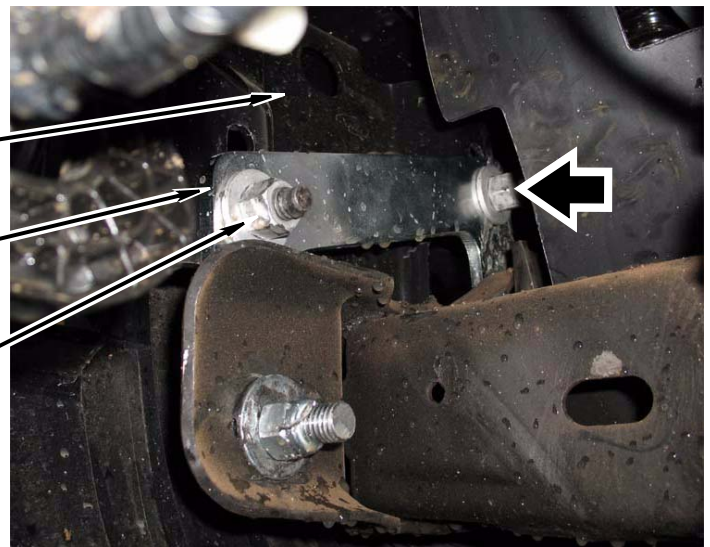

- e. Adjust bumper to body clearance and TORQUE nuts (14 and 164) to 55 lb-ft.



- f. Install push clip (12) and wire harness (13) on front bumper (7).
- g. If so equipped, install two connectors (10) on fog lamps (11).

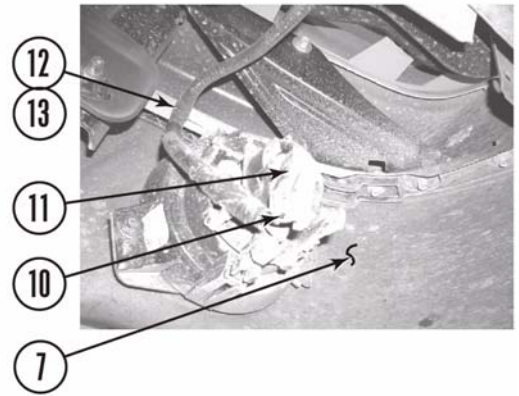

**⚠WARNING**  
 The following procedure is intended only to enhance the appearance of the vehicle. The rear bumper will no longer be rated for towing of any kind. Towing with the rear bumper after it has been lifted can result in death, serious personal injury, or damage to the vehicle. Towing after the bumper has been lifted should be accomplished using a rated Class III receiver type hitch.

16. Install the rear bumper.

- a. Coat threads of eight nuts (102) and two bolts (108) with Loctite®.
- b. Install two *kit* rear bumper brackets (165) on rear bumper (99) with two double stud fasteners (111) and four nuts (102). Do not tighten.
- c. Install two outside rear bumper brackets (110) on *kit* rear bumper brackets (165) with two bolts (108) and nut plates (109). Do not tighten.
- d. If NOT equipped with a trailer hitch, install two *kit* spacers (166) and two *kit* rear bumper brackets (165) on frame (15) with two double stud fasteners (111) and four nuts (102). Do not tighten.

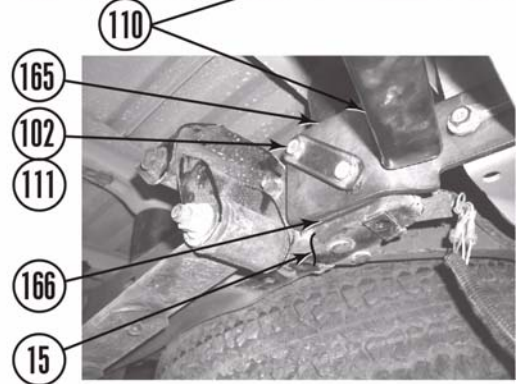
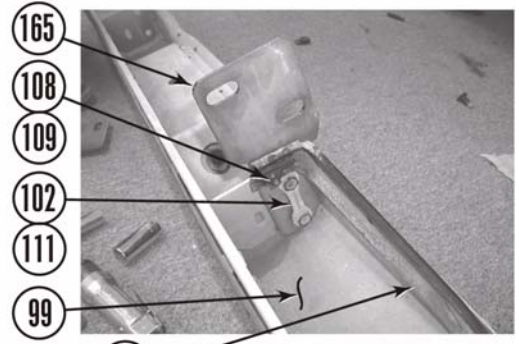
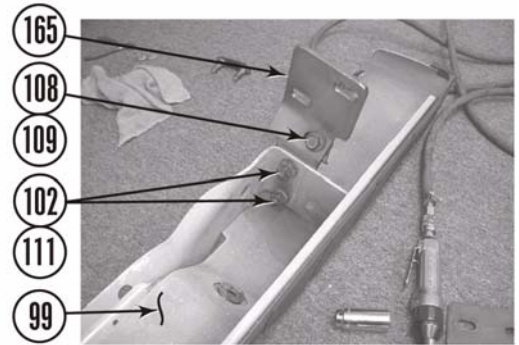

e. If equipped with a trailer hitch, install two *kit* rear bumper brackets (165) on frame (15) with two double stud fasteners (111) and four nuts (102). Do not tighten.

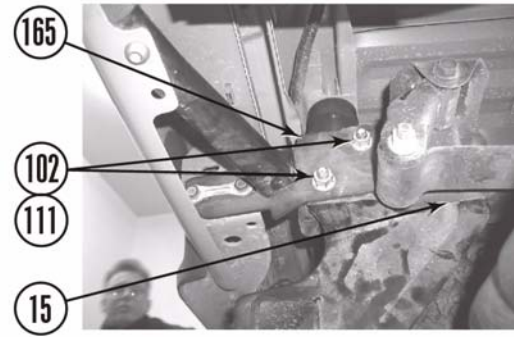

f. Adjust bumper to body clearance and tighten eight nuts (102), two bolts (108), and two screws (107), to 55 lb-ft.

g. Install connector (105) and harness (106) on bed (97).

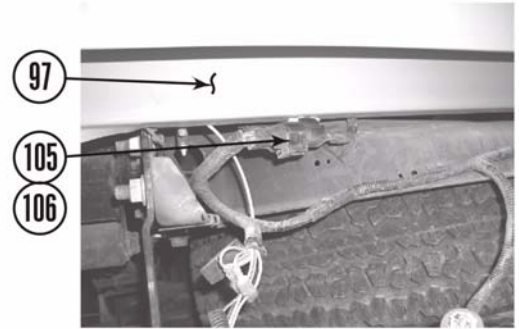

h. Install two license plate lights (101) in rear bumper (99).

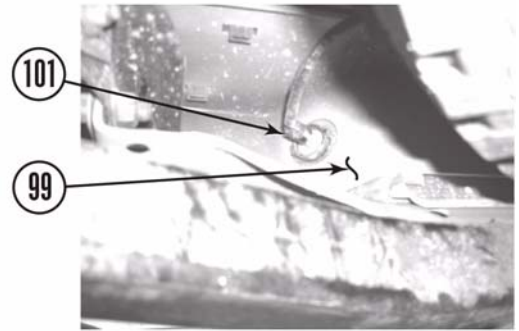

i. If removed, connect trailer hitch connector (100) on rear bumper (99).



- j. Weld four *kit* bed crush blocks (167) on frame (15) as shown.

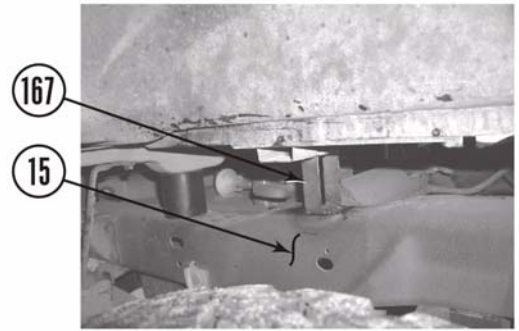

**D. After installation is complete.**

- 1. Install airbag fuse #26 (5) in fuse panel (6) and install the cover (4) or passenger side kick panel.

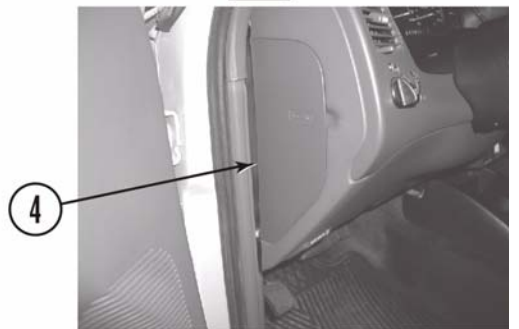
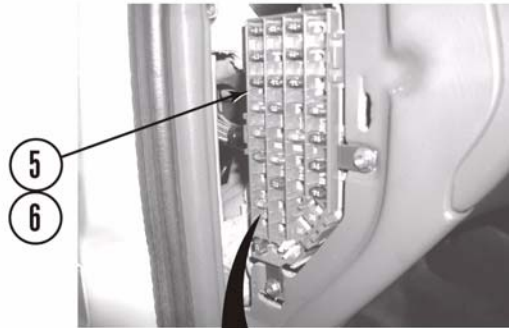

- 2. Connect both battery cables to the battery (3). Be sure to reconnect the positive cable (2) first, then the negative cable (1).

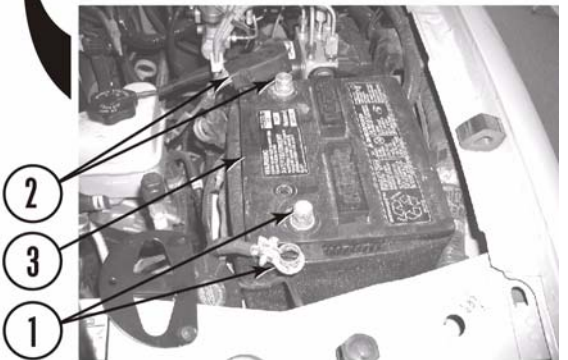

3. Stick *kit* warning sticker on the dash in plain sight of all vehicle occupants.
4. Double check the vehicle.

**⚠CAUTION**

Retorque all fasteners after 500 miles and after off road use. All body lift components should be visually inspected and fasteners retorqued during routine vehicle servicing.

- a. Check all mounting hardware to ensure it is properly tightened.
- b. Check all wires, hoses, cables, etc. to ensure they have been properly connected and there is ample slack. With the number of hoses on this vehicle, it is vital that this be checked thoroughly.
- c. Check vehicle electrical system.
- d. Start vehicle and check the steering in both directions to ensure that there is no bind.
- e. Check the operation of the brake system and the parking brake.

**⚠NOTE**

Step 5 is for vehicles with manual transmission only. Other models skip this step.

5. Check clutch operation. Check transmission shift lever operation. Ensure that there is proper engagement in all gears.

**⚠NOTE**

Step 6 is for vehicles with manual 4 wheel drive transfer case only. Other models skip this step.

6. Check manual 4 wheel drive transfer case shift lever operation. Ensure there is complete engagement in all ranges.
  - a. If shift lever makes contact with floorboard, remove shift lever knob and boot, and notch floorboard to ensure complete engagement in all ranges.
  - b. If shift lever still makes contact with floorboard, modify boot and reinstall boot and knob. Ensure there is complete engagement in all ranges.

**⚠CAUTION**

**Never open a closed cooling system after the vehicle has been started. Only fill the cooling system if the cap has been removed while the vehicle was still cold.**

- c. Check coolant level. Fill coolant to the proper level (refer to the Owner's Manual).
- d. Test drive vehicle in all gears and 4 wheel drive ranges. Pay close attention to all vehicle systems. Check all hardware again in 500 miles and as part of your regular maintenance schedule.

**⚠CAUTION**

Performance Accessories does not recommend any particular wheel and tire combinations for use with its body lifts and cannot assume responsibility for the customer's choice of wheels and tires. Reference your owner's manual for recommended tire sizes and warnings related to the use of oversized tires. Larger wheel and tire combinations increase stress and wear on steering and suspension components, which leads to increased maintenance and higher risk for component failure. Larger wheel and tire combinations also alter speedometer calibration, braking effectiveness, center of gravity, and handling characteristics. Consult with an experienced local off road shop to find what wheel and tire combinations work best with your vehicle.

**⚠NOTE**

All warranty information, instruction sheets, and other documents regarding the installation of this product must be retained by the vehicle owner. Information contained in the instructions and on the warranty card will be required for any warranty claims. The vehicle owner needs to understand the modifications made to his vehicle and how they affect vehicle handling and performance. Failure to provide the customer with this information can result in damage to the vehicle and severe personal injury.

## E. Kit Parts List.

Manual Transmission Vehicles Require KIT # 3700

Quantity	Description
	<b>Kit</b>
16	3 x 3 blocks
2	Front bumper brackets
2	Rear bumper brackets
2	Rear bumper spacer brackets
1	Extension (1-1/4" x 5")
1	Extension (1-1/8" x 5")
2	Rectangular radiator brackets w/clip nuts
4	Bed crush blocks
1	Warning to driver sticker
1	Logo sticker
1	6ml bottle Loctite
1	Hose (3/8" x 16" rubber)
1	<b>Bolt pack BP70033</b>
2	12mm x 1.75 x 200mm bolts
8	12mm x 1.75 x 180mm bolts
6	12mm x 1.75 x 160 mm bolts
2	12mm x 1.75 x 140mm bolts
6	7/16" USS washers
8	1 3/4" thick washers
1	Steering extension
1	3/8" x 1 1/2" bolt
2	3/8" SAE washers
1	3/8" nylock nut
1	parking brake bracket
3	5/16" x 1" bolts
4	5/16" USS washers
3	5/16" nylock nuts
4	1/2" USS washers
4	1/2" nylock nuts
1	<b>Hardware pack HP70033</b>
	<b>Bolts</b>
2	5/16" x 1" bolts
2	1/4" x 1" bolts
	<b>Washers</b>
2	5/16" USS washers
10	1/4" SAE washers
1	8mm washer
	<b>Nuts</b>
8	1/4" nylock nuts
1	8mm nylock nut
	<b>Miscellaneous</b>
2	3" long stud radiator brackets
4	3" short stud bracket
2	L-shaped brackets (short)
1	Vent hose extension
2	#10 hose clamp
2	#28 hose clamps
1	Rubberized wire loom clamp
1	Thick metal clamp



Front bumper bracket



Rear bumper bracket



Rear bumper spacer bracket

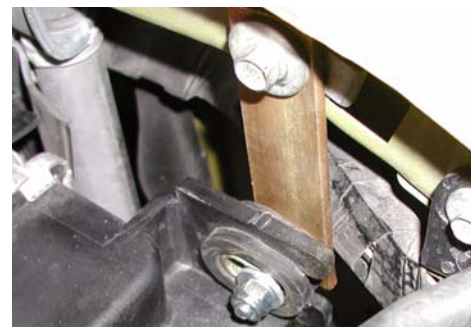

Radiator stud bracket



Radiator square bracket