



841 S. 71st Avenue • Phoenix, AZ 85043
(623) 907-0081
www.performanceaccessories.com

2000-2002 DODGE DURANGO 3" BODY LIFT KIT INSTALLATION INSTRUCTIONS KIT #PA60053

⚠WARNING

Installation of a Performance Accessories body lift will change the center of gravity and the handling characteristics of the vehicle. Because of the higher center of gravity and larger tires, the vehicle will handle and react differently both on and off road. You must drive it safely! Extreme care must be taken to prevent vehicle rollover or loss of control, which could result in serious injury or death. Avoid sudden sharp turns or abrupt maneuvers and always make sure all vehicle occupants have their seat belts fastened.

⚠WARNING

Read and understand all instructions, warnings, cautions, and notes in this sheet and in your owners manual before you begin the installation of this body lift kit.

⚠CAUTION

Proper installation of a Performance Accessories body lift kit requires knowledge of the factory recommended procedures for disassembly and assembly of original equipment components. We recommend that the factory shop manual and any special tools necessary to your vehicle be on hand during the installation. Installation of this body lift kit without proper knowledge of the factory recommended procedures may affect the performance of these components and the safety of your vehicle. We strongly recommend that a certified mechanic familiar with the installation of similar components install this body lift kit.

⚠WARNING

This body lift kit should only be installed on vehicles in good working condition. Before installation, the vehicle should be thoroughly inspected for evidence of corrosion or deformation of the sheet metal around the factory body mounts. This body lift kit should not be installed on any vehicle that is suspected to have been in a collision or misused. Off road use of your vehicle with this body lift installed may increase the stress applied to the factory body mounts. We do not recommend that any vehicle with a body lift installed be involved in any extreme off road maneuvers such as jumping. Failure to observe this warning may result in serious personal injury and/or severe damage to your vehicle.

⚠WARNING

Performance Accessories strongly discourages the use of a suspension lift kit or any other lift device in addition to a body lift kit. A vehicle that uses a combination of lift devices not originally engineered to be used together may result in unexpected and unsafe handling characteristics. Many states now have laws restricting bumper heights and vehicle lifts. Local laws should be consulted to determine if the changes you intend to make to your vehicle comply with state laws.

⚠WARNING

The installation of larger wheel and tire combinations may reduce the effectiveness of the Anti-lock Braking System.

⚠WARNING

Always wear eye protection when operating power tools.

⚠WARNING

Ensure that your vehicle tires are properly blocked and secured before you begin installation of this lift kit.

⚠NOTE

Performance Accessories recommends using the Loctite® supplied in the kit on all hardware unless noted in the instructions.

⚠NOTE

You will find it easier to keep track of hardware if immediately after removal you put the fasteners for each sub-assembly in a paper lunch bag and write on the bag where they go.

A. Before you start.

NOTE

As you read through this procedure, note that each part referenced has the same callout number throughout. Also, the part number in the text matches the corresponding part number in the art. Kit parts are prefaced by the word *kit* in italics.

1. Read all warnings and instructions completely and carefully before you begin.
2. Check to make sure the kit is complete (refer to the Parts List, section E).
3. Only install this kit on the vehicle for which it is intended. If anytime during the installation you encounter something different from what is outlined in the instructions, call technical support at (520) 636-0979.
4. Park the vehicle on a clean, dry, flat, level surface and block the tires so the vehicle cannot roll in either direction.
5. Lower the spare tire (1) to the ground (refer to the owner's manual).
6. Disconnect both battery cables. Disconnect the negative cable (2) first, then the positive cable (3). Remove battery (4) from vehicle (refer to the owner's manual).

WARNING

The Supplemental Restraint System (SRS, or air bag) must be deactivated during lift kit installation to avoid accidental air bag deployment while working near SRS sensors and wiring. Do not allow anyone near the air bag during lift kit installation. Accidental deployment can result in serious personal injury or death. Refer to your factory service manual/owner's manual for the recommended procedure to disable the SRS. The SRS must be reactivated before driving the vehicle.

7. Remove two air bag fuses (5) from the fuse box (6) (see the owner's manual for fuse location).

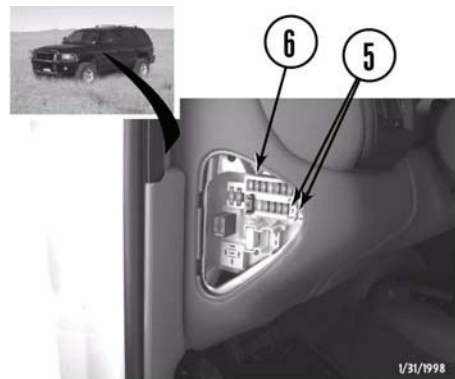
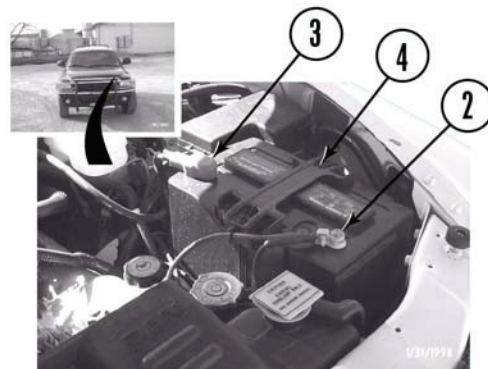
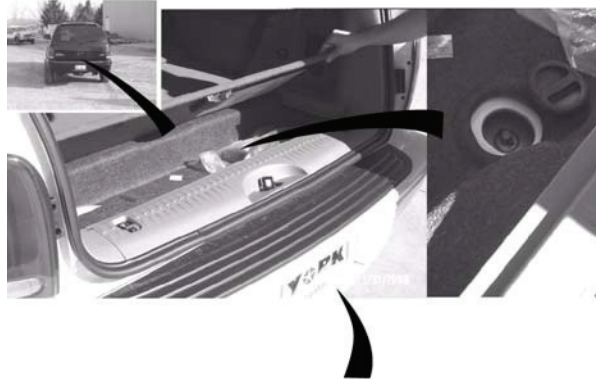

B. Get ready to install the kit.

1. Remove the shift apparatus.

a. Remove two scuff plates (7 and 8) from the door jambs (9) on both sides of the body (10).

b. Remove two screws (11) and kick panels (12) from floorboard (13) and pull back carpet to expose screws (14).

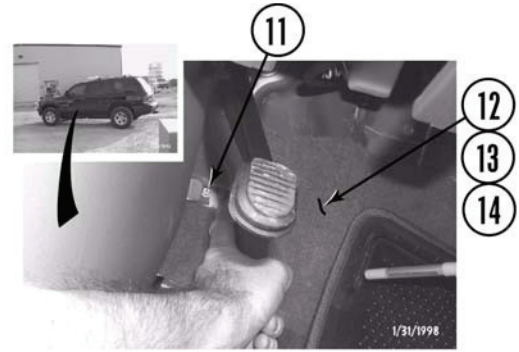

c. If equipped with bucket seats and center storage console, remove rubber insert (15) and two bolts (16) from the cup holders (17).

d. Remove cover (18), nut (19), and shift knob (20) from transfer case shift lever (21).

e. If equipped with manual 4wd, remove shift boot (22) and plastic shift housing (23) from the transfer case shift lever (21). Disconnect wire harness connector (24) inside housing before removing from vehicle.

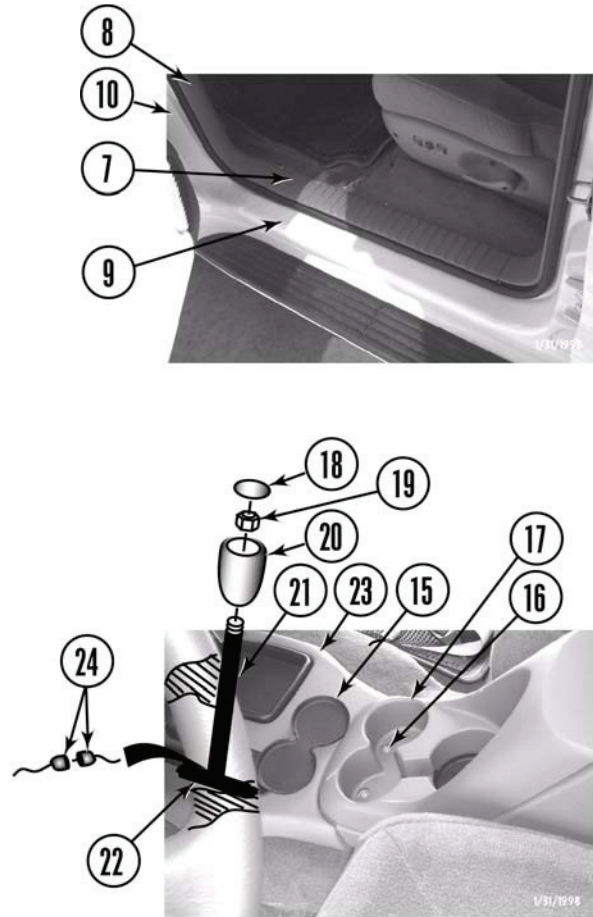

f. Remove four screws (25) from inside the console (26). Remove console from the floorboard (13).

g. The front of the shift housing (27) snaps into place. Gently pull up on the shift housing front until the clips (28) release.

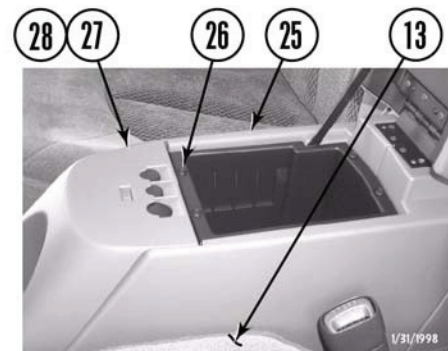

- h. Disconnect vent linkage (29) from two vents (30).
- i. Remove eight screws (31) and the steel shift housing (32) from the floorboard (13).

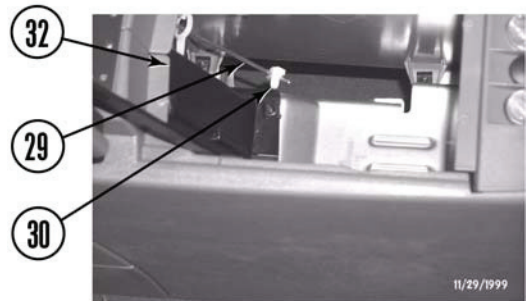
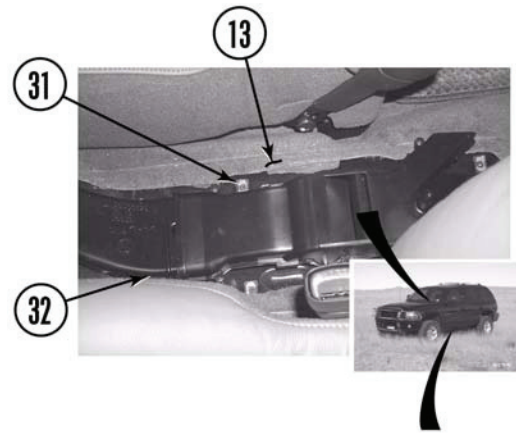

- j. If present on your vehicle, remove four bolts (33) and skid plate (34) from the frame (35) under the transmission and transfer case.

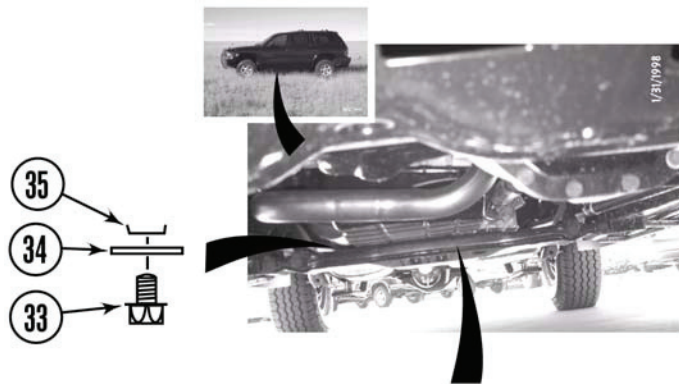

- k. Remove nut (36) from the transfer case linkage (37) and the transfer case (38).
- l. Remove two bolts (39) and the transfer case shift lever (21) from the side of the transfer case.

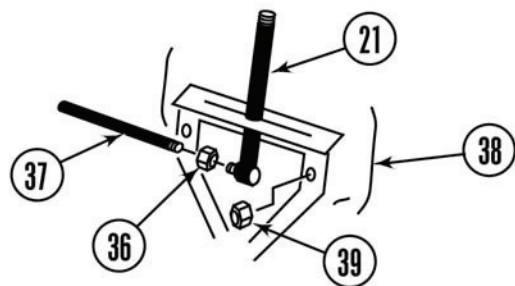

2. Remove the front bumper.

a. Remove nine panel clips (40), plastic cover (41), and rubber cover (42) from the core support (43).

b. If present on your vehicle, disconnect two wire harness connectors (44) from the driving lights (45).

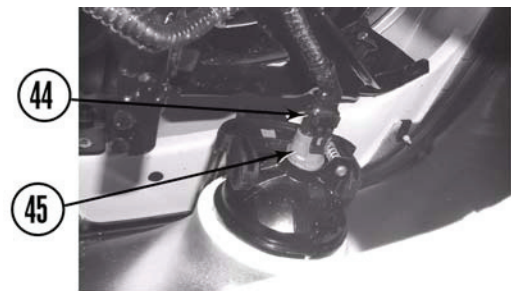
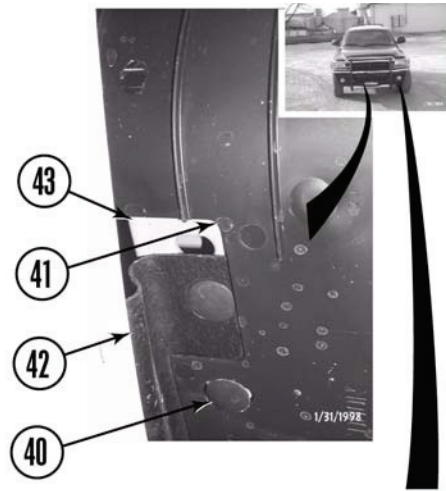

c. Remove four nuts (46), bolts (47), and two front bumper outer brackets (48) from the frame (35).

d. Remove four bolts (49) and front bumper (50) from the frame (35) inner mounts.

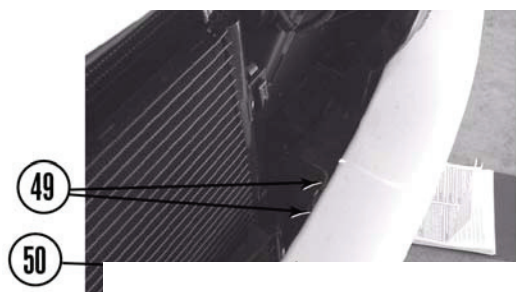
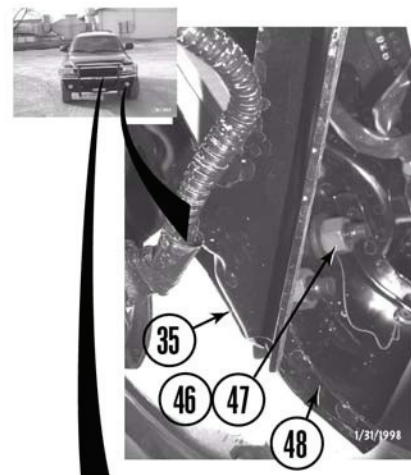

3. Remove the rear bumper.

- a. Disconnect two wire harness connectors (51) from the license plate lights (52).
- b. Remove two plastic screws (53) from the rear bumper (54).

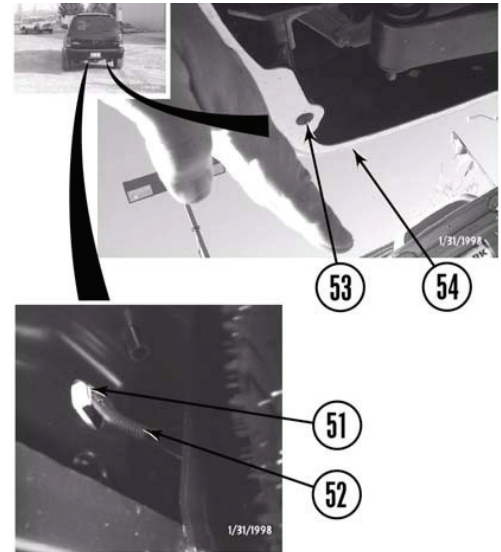

- c. Remove four nuts (55) from rear bumper (56) and two outer brackets (56).
- d. Remove four nuts (57) and the intermediate brackets (58) from the frame (35).
- e. Remove four nuts (59) and rear bumper (54) from the inner brackets (60) and the frame (35).

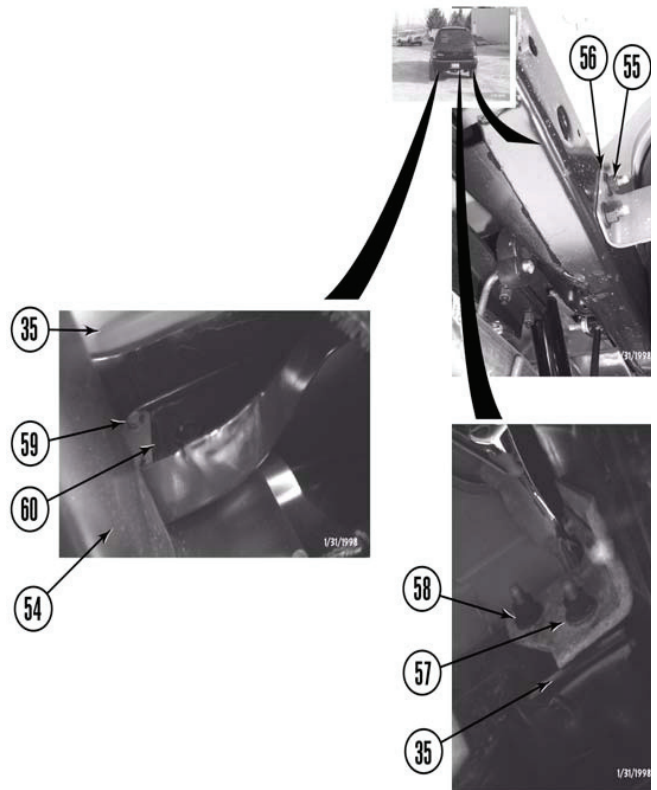

4. Remove four wire harness clips (61) and wire harness (62) from the core support (43).
5. Remove four bolts (63) and the fan shroud (64) from the radiator (65) and allow shroud to rest against the engine.

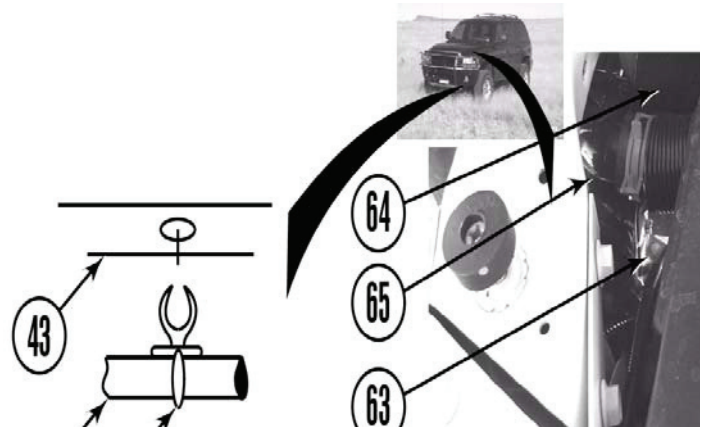

6. Remove firewall mounted ground wires.
 - a. Ensure two ground wires (66) on the firewall (67) have ample slack to allow for lifting.
 - b. If not, remove two nuts (68) and reroute the ground wires (66).
 - c. Install two ground wires (66) on the firewall (67) with two nuts (68).
 - d. If driver's side ground wire still does not have enough slack, install *kit* extension bracket (69) on the firewall (67) with nut (68).
 - e. Install ground wire (66) on *kit* extension bracket (69) with *kit* 1/4" X 1" bolt (70), two *kit* 1/4" washers (71), and *kit* 1/4" nylock nut (72).

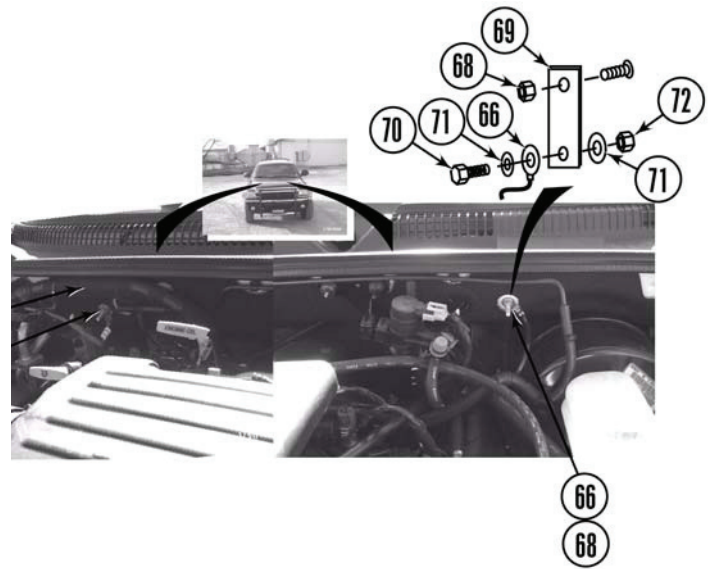

7. Locate ground wire (66) on the passenger's side frame rail (73).
 - a. Remove bolt (74) and ground wire (66) from the frame rail (73).
 - b. Install the *kit* ground strap extension bracket (75) with bolt (74).
 - c. Install ground wire (66) on the extension bracket (75) with *kit* 1/4" X 1" bolt (76), two *kit* 1/4" washers (77), and *kit* 1/4" nylock nut (78).

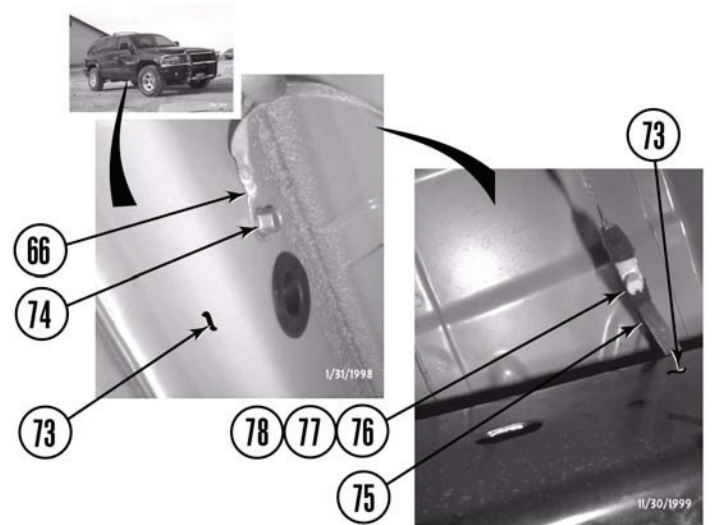

8. Locate wire harness (79) and ground wire (80) on the driver's side frame rail (81) behind the front tire.

a. Remove plastic cover (82) from driver's side front wheel well (83) and top of the frame rail (81).

b. Remove wire harness panel clip (84) from the top of the frame rail (81).

c. Remove bolt (85) and ground wires (80) from the frame rail (81).

d. Install the *kit* ground strap extension bracket (86) with bolt (85).

e. Install ground wire (80) on the extension bracket (86) with *kit* 1/4" X 1" bolt (87), two *kit* 1/4" washers (88), and *kit* 1/4" nylock nut (89).

f. Install two wire harnesses (79 and 90) to transmission lines (91) with two *kit* zip ties (92).

9. Remove brake lines (93) from plastic clips (94) on the frame rail (81).

10. Remove two bolts (95) and brake line brackets (96) from the frame rail (81).

11. Remove automatic transmission cable (97) from automatic transmission cable loop (98) on the driver's side front wheel well (83). Ensure cable has ample slack to allow for lifting.

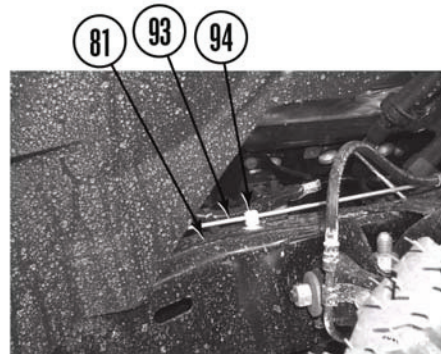
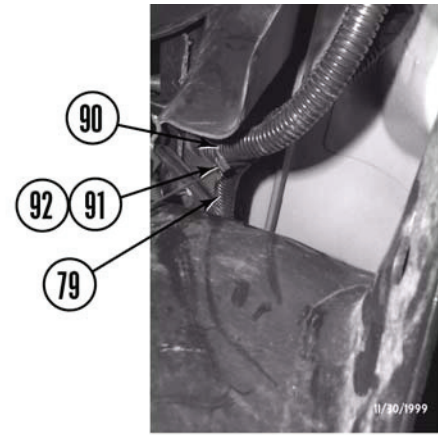
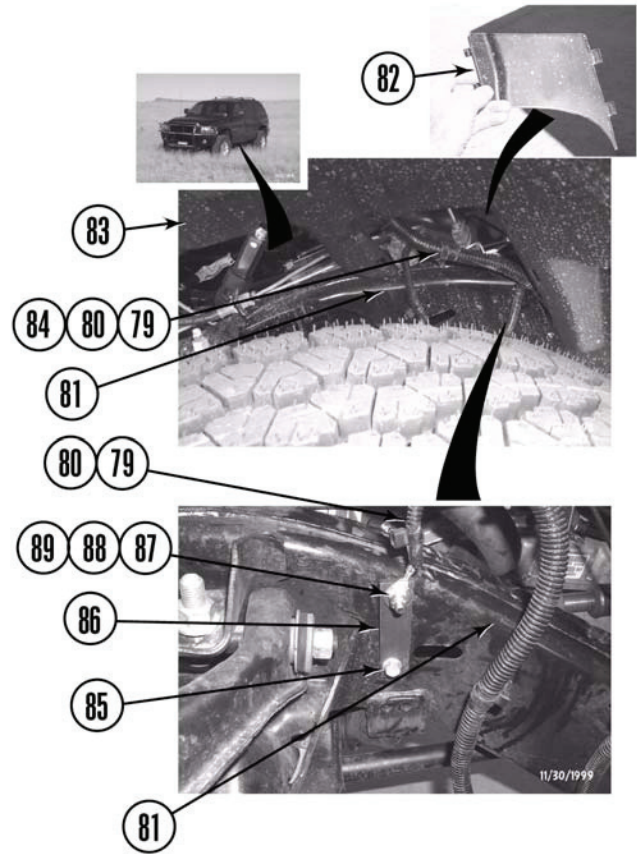

NOTE

Ensure steering shaft does not turn independently of the steering gearbox. This could cause the air bag system to malfunction, resulting in serious personal injury or damage to the equipment.

12. Remove bolt (99), loosen bolt (100), and slide steering shaft (101) up and off of the steering rack (102).

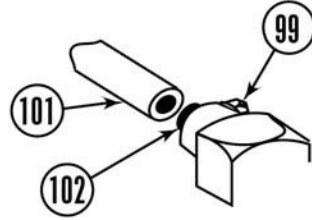

WARNING

Use extreme caution when working near fuel lines and fuel tank. Clean up spilled fuel immediately. Any spark could cause an explosion or fire resulting in serious personal injury and property damage.

13. Remove two clamps (103 and 104), nut (105), fuel filler (106), and vent hose (107) from the fuel tank (108) and the fuel filler neck (109).

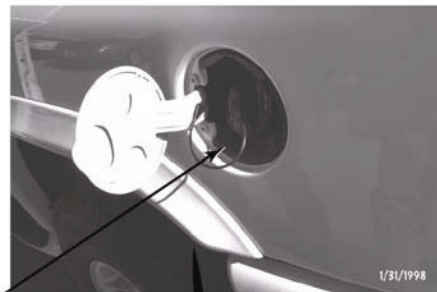
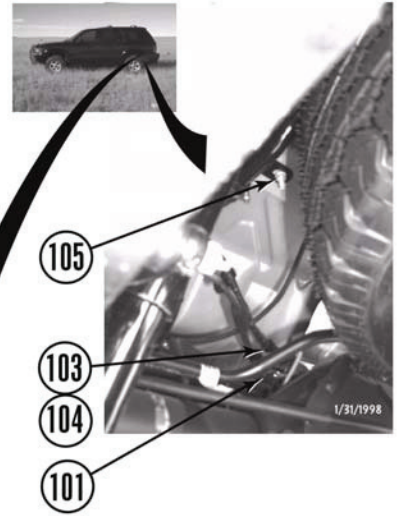

109

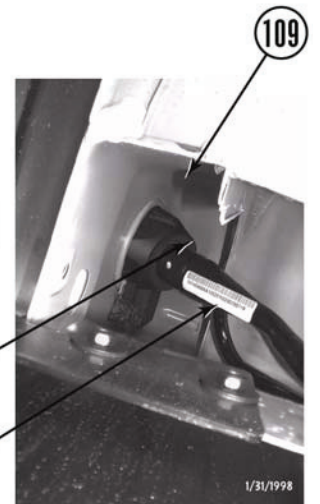

106

107

- Loosen but do not remove twelve body mounting bolts (110).

C. Install the kit.

⚠WARNING

Failure to replace the OEM body mounting hardware (except mounting bolts in the kit) in the stock locations could result in serious personal injury or damage to the vehicle.

- Install the body passenger side spacer blocks.

⚠WARNING

Use extreme caution when lifting body from frame. Ensure lifting device is securely placed. Keep hands out from between frame and body, or serious personal injury could result.

⚠CAUTION

Continually check hoses, wires, lines, etc. to be sure that everything is flexing properly and not binding, or damage to the vehicle could result. Be especially careful of the a/c hose at the firewall, the belt pulley, and at the core support. Ensure brake lines stretch while lifting. Bending the lines to gain ample slack may be necessary. Be extremely careful not to kink the lines.

⚠NOTE

Ensure stock spacers and body mounting pads stay on vehicle unless otherwise specified in these instructions. Kit spacer blocks are installed in addition to the stock spacers and body mounting pads.

- Remove bolt (110) and washer (111) from the core support frame mounting pad (112).
- Remove five bolts (110) and washers (113) from the frame mounting pads (112) and body mounting pads (114).

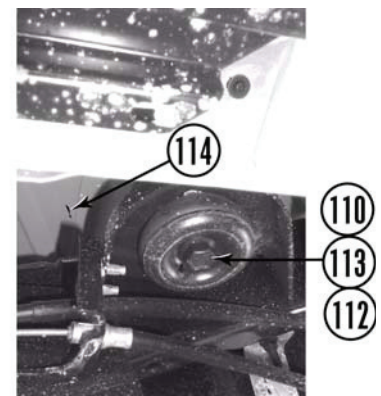
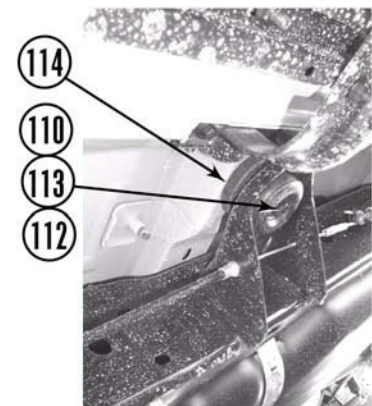
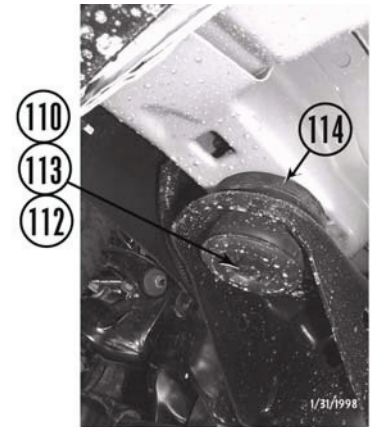
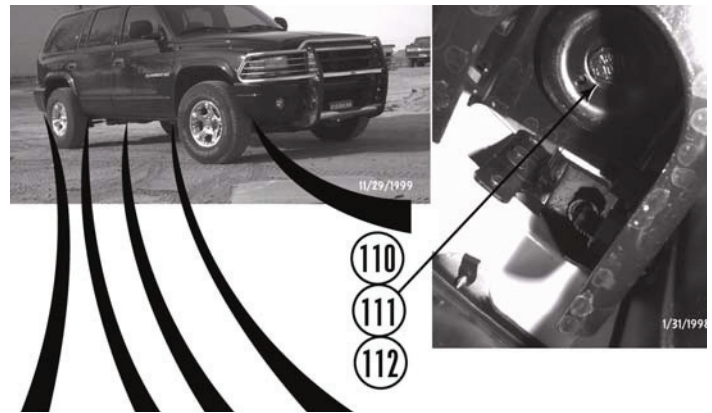
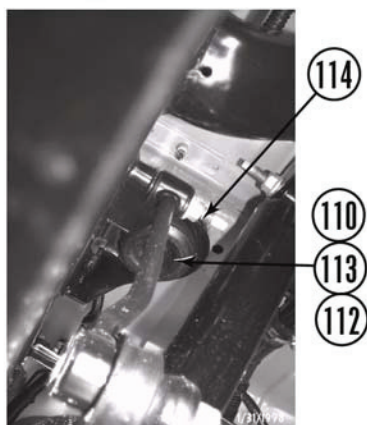
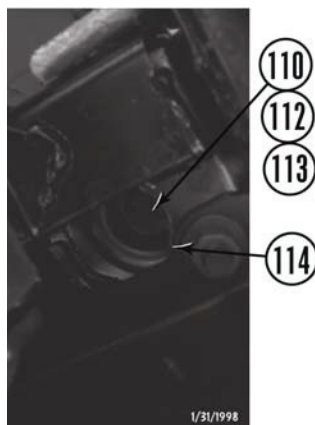

c. Using a hydraulic jack and a wooden block, slowly lift the body (10) passenger side just high enough to position the *kit* spacer blocks (115) on the frame mounting pads (112).

d. Position six *kit* spacer blocks (115) on top of the passenger side core support and frame mounting pads (112).

e. Install a *kit* 12mm x 160mm bolt (116) (12mm x 140mm for a 2" kit) and a *kit* 7/16" USS washer (117) through the bottom bushing retainer (118), bottom bushing (119), frame mounting pad (120), upper bushing (121), upper bushing retainer (122), *kit* spacer block (123), and in the body mounting pad (114). Do not tighten.

f. Lower body (10) on the *kit* spacer blocks (115).

2. Install the driver's side spacer blocks.

a. Repeat steps C. 1. a. through f. for the vehicle driver's side.

3. Finish the cab spacer block installation.

a. Remove twelve bolts (116) one at a time, coat threads with Loctite®, and reinstall. Tighten to 55 lb-ft.

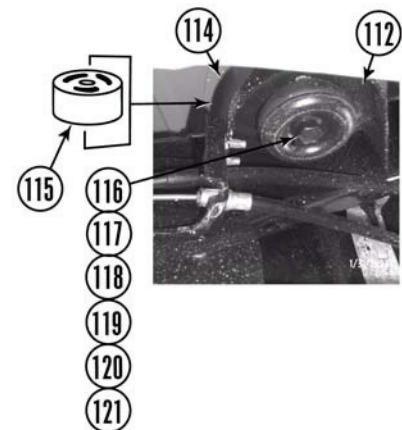
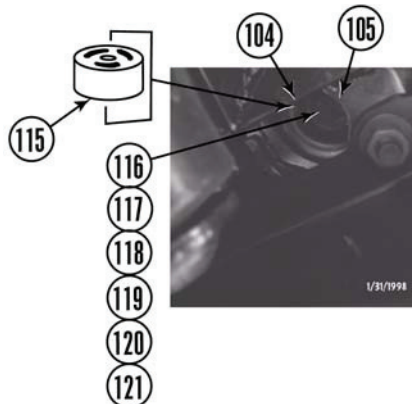
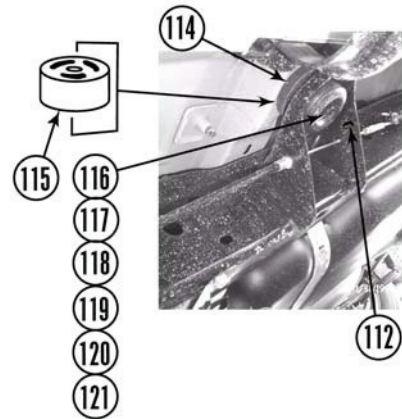
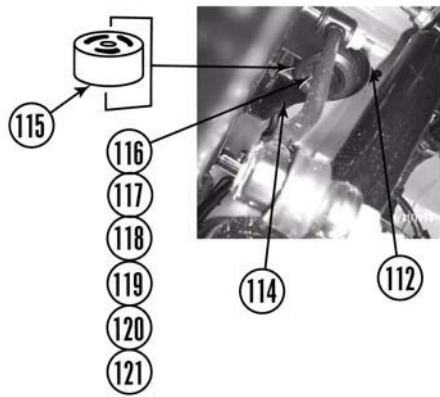
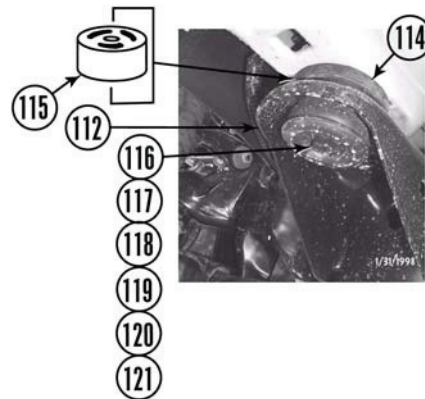
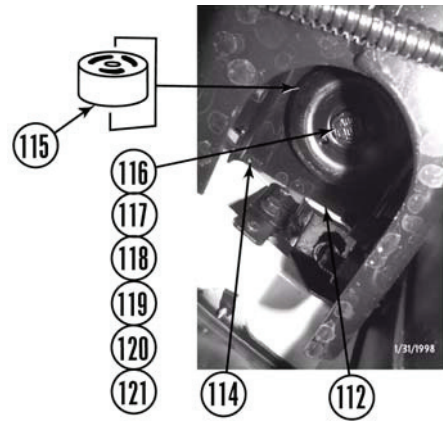

⚠WARNING

Use extreme caution when working near fuel lines and fuel tank. Clean up spilled fuel immediately. Any spark could cause an explosion or fire resulting in serious personal injury and property damage.

4. Lengthen and install the fuel filler hose.

a. Cut the fuel filler hose (106) six inches from the fuel tank end as shown.

b. Install the *kit* 1 1/8" x 5" fuel filler extension (122) between the two cut sections with two *kit* #28 hose clamps (123) at each end of the extension.

c. Remove the vent hose (107) and install the *kit* 3/4" x 17" vent hose (124) with two *kit* # 10 hose clamps (125).

d. Install fuel filler (106) and vent hose (107) on fuel tank (108) and fuel filler neck (109) with two clamps (103 and 104) and nut (105).

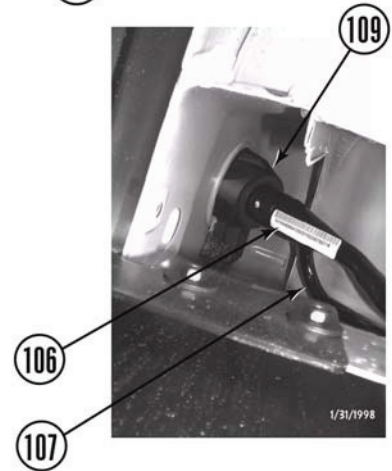
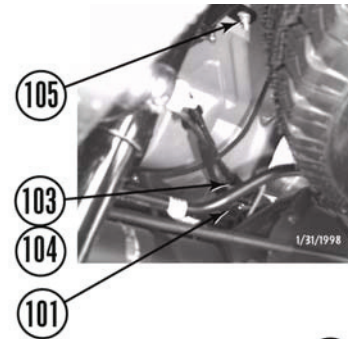
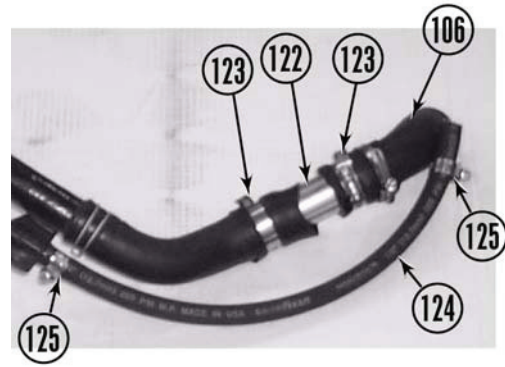

5. Install *kit* steering extension.

a. Coat threads of retaining bolts (99, 100, and 126) with Loctite®.

NOTE

Ensure both stock and *kit* retaining bolts are installed across the recessed areas of the steering gearbox input shaft. After each mounting bolt has been installed, try to pull the extension off the shaft. If it comes off, the extension has not been installed properly.

b. Install *kit* steering extension (127) on the steering rack (102) with the *kit* retaining bolt (126). Do not tighten.

c. Install steering shaft (101) on *kit* steering extension (127) with the stock retaining bolt (99).

d. Tighten bolts (99, 100, and 126) to 20 lb-ft.

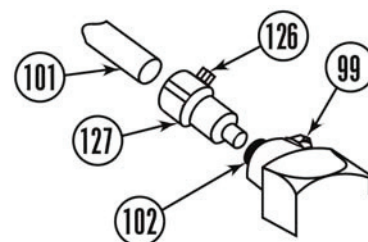

6. Install the fan shroud.

NOTE

While cutting away mounting flange, be careful not to damage any of the hoses or lines in the area.

- a. Drain the radiator (65) into a clean pan (refer to the owner's manual).
- b. Disconnect washer fluid hose (128) from the fan shroud (64).
- c. Remove four bolts (129) and fan (130) from the water pump (131). Allow fan to rest inside shroud (64).
- d. Remove fan shroud (64) and fan (130) from the vehicle. Separate upper fan shroud from lower fan shroud.
- e. Remove two clamps (132) and lower radiator hose (133). Turn hose 180 degrees and reinstall with two clamps.
- f. Cut the lip from the lower fan shroud (64) as shown and join upper fan shroud to lower fan shroud.
- g. Position fan (130) and fan shroud (64) in the vehicle.
- h. Install fan shroud (64) on the radiator (65) with four bolts (63). Do not tighten.
- i. Install fan (130) on the water pump (131) with four bolts (129).
- j. Adjust fan to fan shroud and fan to hose clearance. Ensure fan cannot contact hoses or the fan shroud. Tighten four bolts (63).
- k. If lower radiator hose (133) appears to be too close to fan (130), cut hose and install hose extension (133a) with two kit clamps (133b).
- k. Connect washer fluid hose (128) on the fan shroud (64).
- l. Fill radiator (65) (refer to the owner's manual).

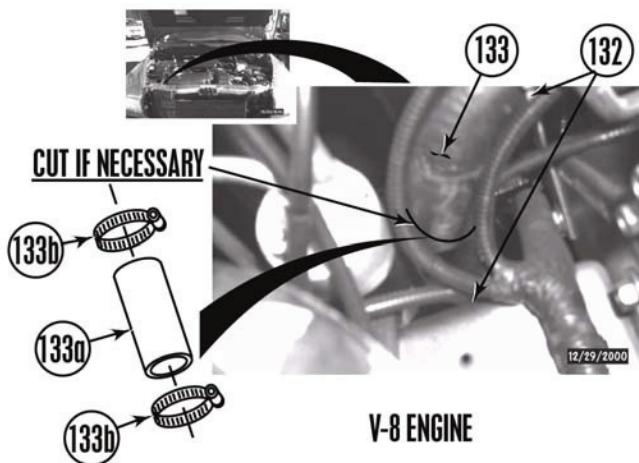
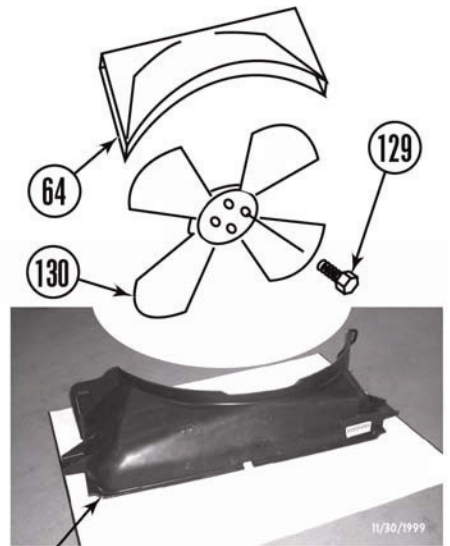
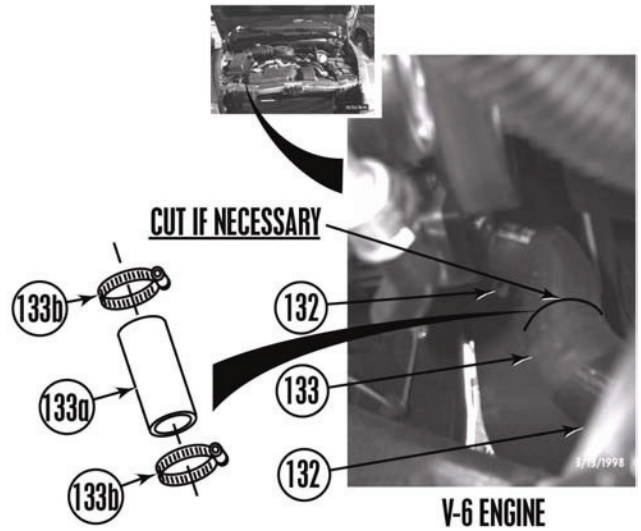

m. Install four wire harness clips (61) in core support (43) holes where possible.

n. Use *kit* zip ties (134) to secure wire harness (62) to the a/c lines (135).

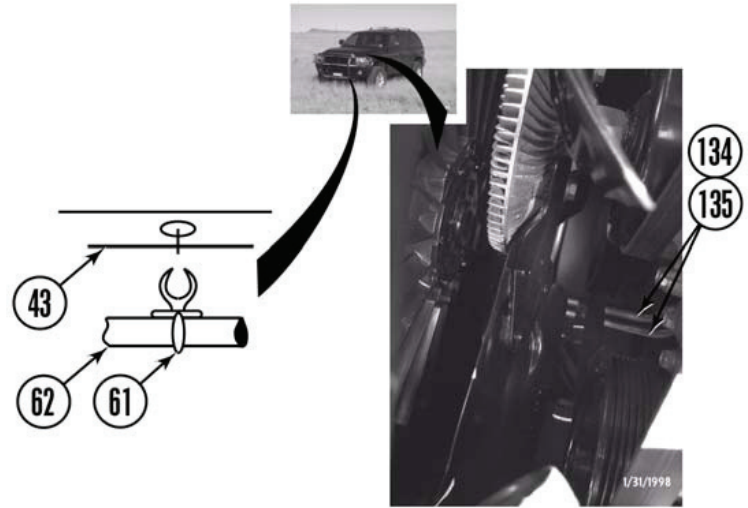

⚠WARNING

Ensure you do not kink brake lines when lifting or if lines must be straightened. If brake lines are kinked, vehicle may not stop when brakes reapplied, resulting in serious personal injury and damage to the vehicle.

7. Check brake lines (93) removed from clips (94) on the driver's side frame rail (81). If necessary, carefully straighten lines to gain more slack.

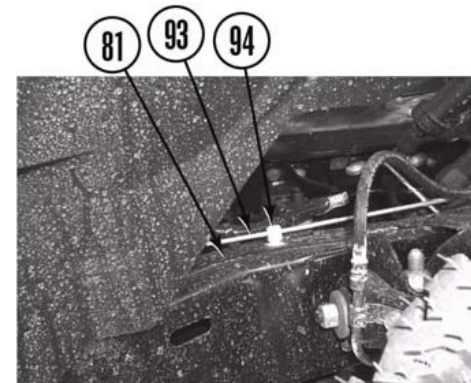

8. Check battery positive cable (3) length. If positive cable is not long enough to reach the battery (4), remove bolt (136) and cable from frame rail (76). Strap cable to the power steering hose (137) with *kit* zip tie (138).

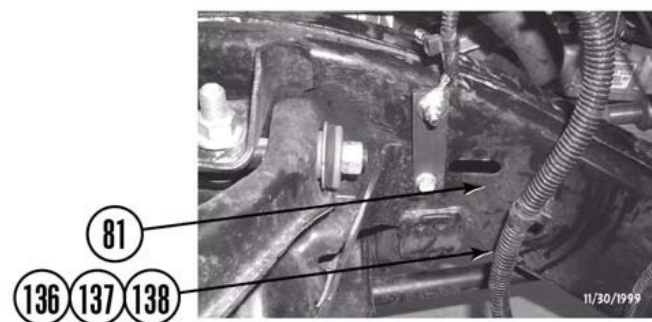
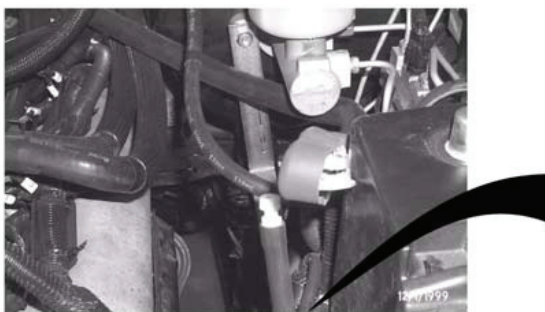
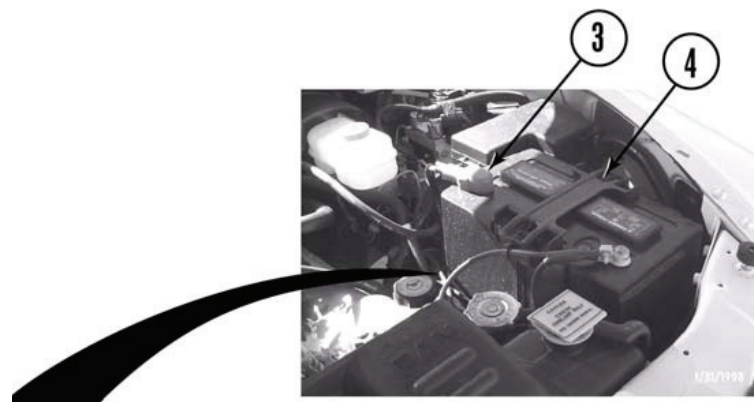

9. Install the front bumper.

a. Coat threads of bolts (47, 49, 142, and 144) with Loctite®.

b. Install two *kit* inner front bumper brackets (139) on frame (35) inner mounts with four bolts (49) (the “C” should open to the rear of the vehicle). Center brackets on mounts. Do not tighten.

c. Install two *kit* outer brackets (140) on the frame (35) with four bolts (47) and nuts (46). Do not tighten.

d. Install front bumper (50) on two *kit* inner brackets (139) with four *kit* 7/16” x 1 1/2” bolts (141), eight 7/16” USS washers (142), and four 7/16” nylock nuts (143). Do not tighten.

e. Install front bumper (50) outer brackets (48) on two *kit* outer brackets (140) with four 7/16” x 1” bolts (144), eight 7/16” USS washers (145), and four 7/16” nylock nuts (146). Insert bolts with heads facing center of vehicle. Do not tighten.

f. Adjust bumper to body clearance and tighten bolts (47, 49, 142, and 144) to 55 lb-ft.

g. If removed, connect two wire harness connectors (44) on driving lights (45).

h. Install rubber cover (42) and plastic cover (41) on core support (43) with nine panel clips (40).

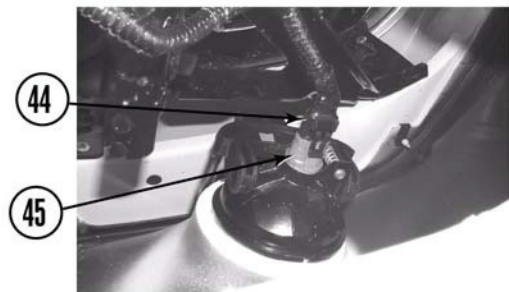
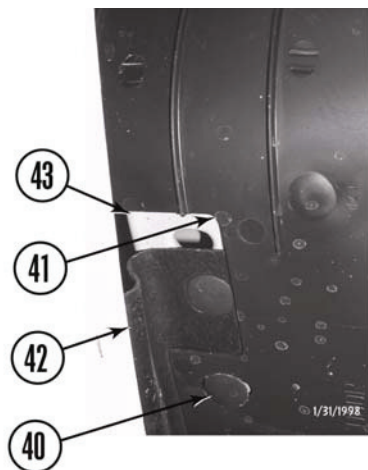
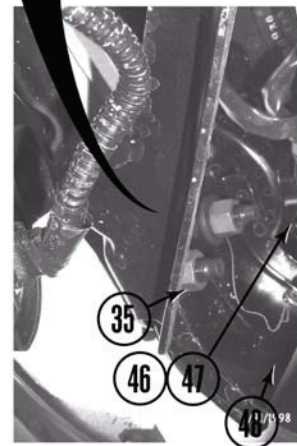
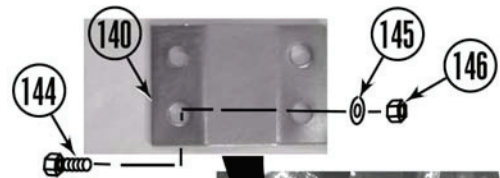
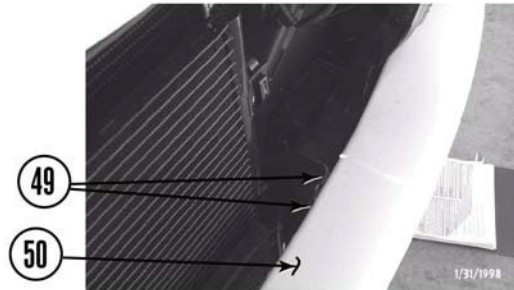
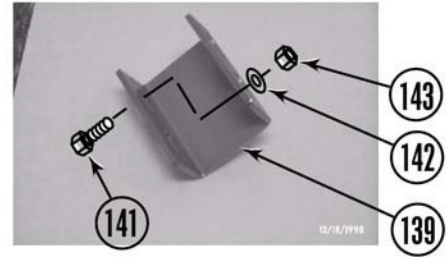

10. Install the rear bumper.

- a. Coat threads of nuts (55, 57, and 59) and bolts (149) with Loctite®.
- b. Install two *kit* outer brackets (147) on rear bumper outer brackets (56) with four nuts (55).
- c. Install two *kit* inner brackets (148) on the rear bumper inner brackets (60) with four bolts (59).
- d. Install rear bumper (54) on two *kit* inner brackets (148) with four *kit* 7/16"x1" bolts (149), eight *kit* 7/16" USS washers (150), and four *kit* 7/16" nylock nuts (151).
- e. Install rear bumper (54) intermediate brackets (58) on the frame (35) with four nuts (57).
- f. Install rear bumper (54) on two *kit* outer brackets (147) with four *kit* 7/16"x1" bolts (149), eight *kit* 7/16" USS washers (150), and four *kit* 7/16" nylock nuts (151).

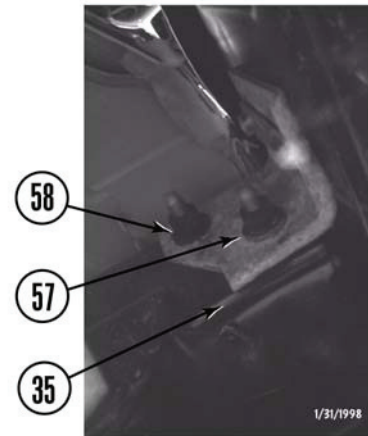
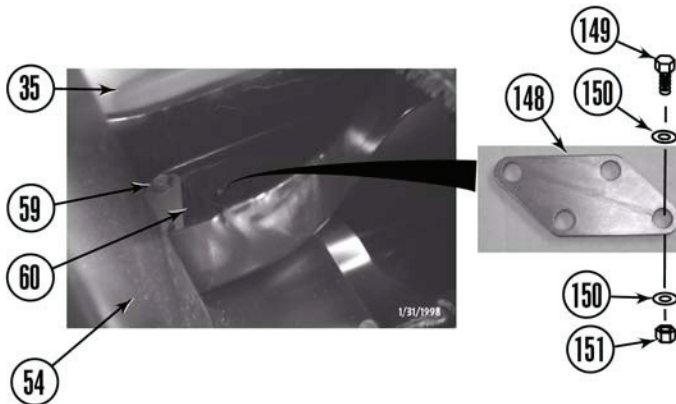
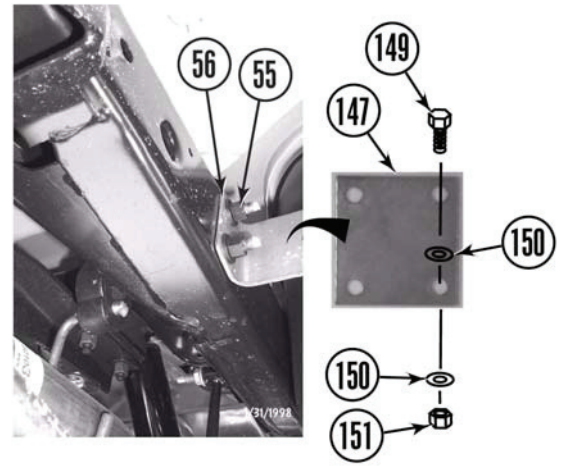

- g. Install two plastic screws (53) on rear bumper (54).
- h. Adjust bumper to body clearance and tighten nuts (55, 57, and 59) and bolts (149) to 55 lb-ft.
- i. Connect two wire harness connectors (51) on license plate lights (52).

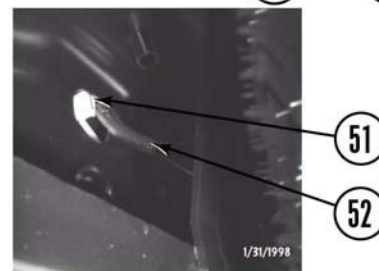
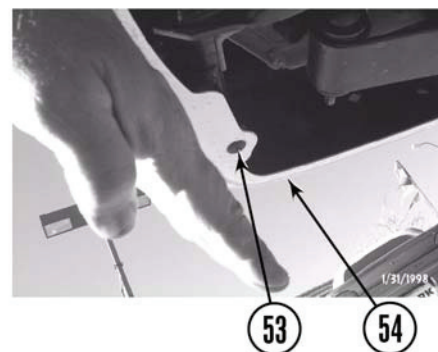

11. Install brake lines.

- Install two *kit* brackets (152) on frame rail (81) with two bolts (95).
- Install two brake line brackets (96) on *kit* brackets (152) with two *kit* 5/16" x 1" bolts (153), six *kit* 5/16" washers (153) and two *kit* 5/16" nuts (154).
- Install plastic clips (94) on brackets (96).
- Install brake lines (93) in the plastic clips (94).

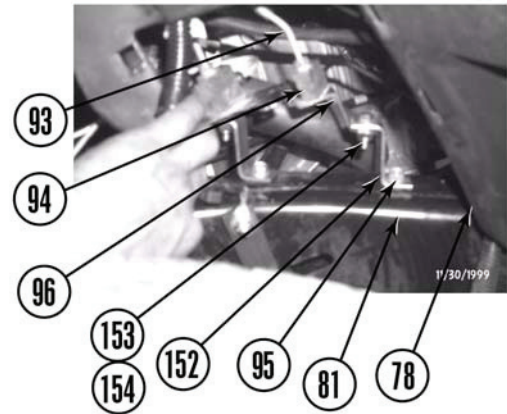

12. Reposition automatic transmission shift cable.

- Remove bolt (155) and automatic transmission cable loop (97) from the driver's side front wheel well (83).
- Install kit bracket (156) and automatic transmission cable loop (97) on the brake booster (157) with a *kit* 1/4"x1" bolt (158), two *kit* 1/4" washers (159), and a *kit* 8mm nylock nut (160).
- Position automatic transmission cable (97) in the automatic transmission cable loop (98).

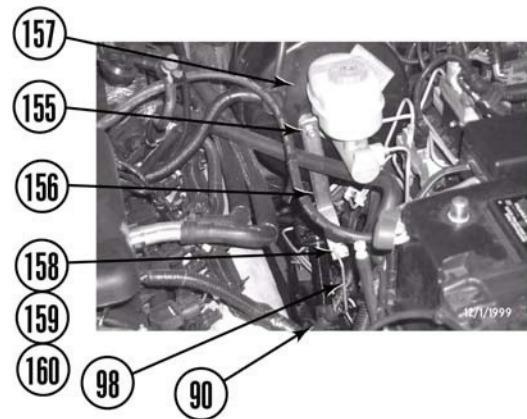

CAUTION

Be careful not to damage any of the parts attached to the shift lever during cutting or welding. A certified welder should perform all welding.

13. Lengthen and install the transfer case shift lever.

- Remove plastic insert (161) from the positioning bracket (162).
- Scribe a line along the transfer case linkage rod (37). Cut linkage into two pieces through line.
- Position *kit* linkage extension (163) between two pieces of the linkage rod (37), insulate rest of shift mechanism to prevent damage while welding, align two halves of scribed line, and weld extension in place.
- Secure transfer case shift lever (21) in a vise. Heat and bend the lever back approximately 1/4" as shown (this will help lever engage transfer case in 2 wheel high).
- Install plastic insert (161) in the positioning bracket (162).

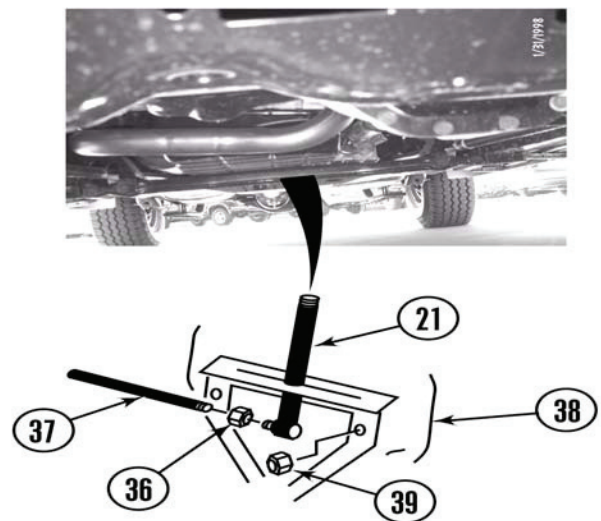

f. Install transfer case shift lever (21) on the transfer case (38) with two bolts (39).

g. Install transfer case linkage (37) on the transfer case shift lever (21) with nut (36).

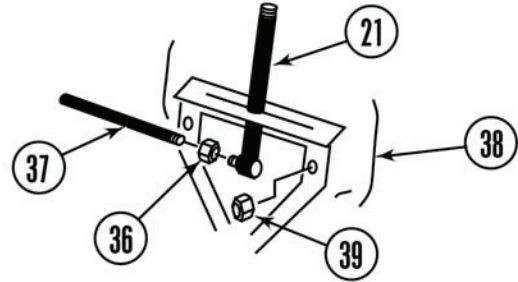

h. Install steel shift housing (32) on the floorboard (13) with eight screws (31).

i. Connect vent linkage (29) on two vents (30).

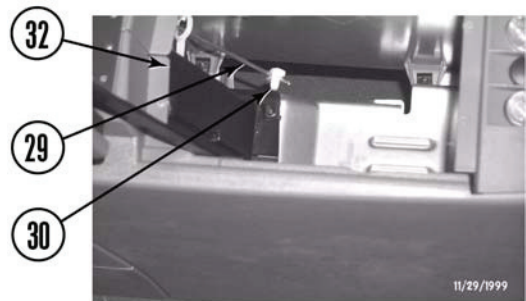
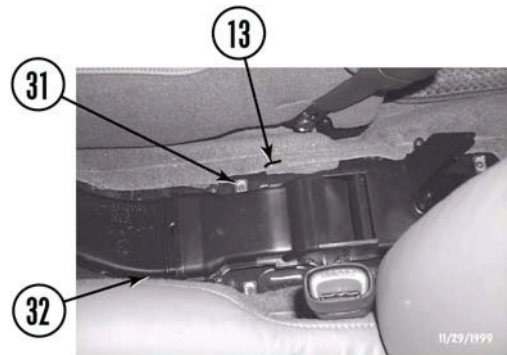

j. Snap shift housing (27) in place on clips (28).

k. If removed, install center storage console (26) on the floorboard (13) with four screws (25).

l. Connect wire harness connectors (24) and install plastic shift housing (23) on the transfer case shift lever (21).

m. Install shift boot (22) over the shift lever (21).

- If necessary, glue boot into place to keep it from moving around when shift lever is operated.
- Check transfer case shift lever (21) operation. Position lever in 4 low. If lever is hitting the plastic shift housing (23), adjust lever. Loosen adjusting nut (36) on the transfer case linkage rod (37). Adjust linkage so lever can be positioned securely in 4 low, but will not be too far forward to stay in 2 high. Once linkage has been properly adjusted. Tighten the adjusting nut (36) securely.

n. Install shift knob (20) on the transfer case shift lever (21).

o. Install nut (19) and cover (18) on the shift knob (20).

p. If removed, install two bolts (16) and rubber insert (15) in the cup holders (17).

q. Install two kick panels (12) on floorboard (13) with two screws (11).

r. Reposition carpet and install two scuff plates (7 and 8) on the door jambs (9).

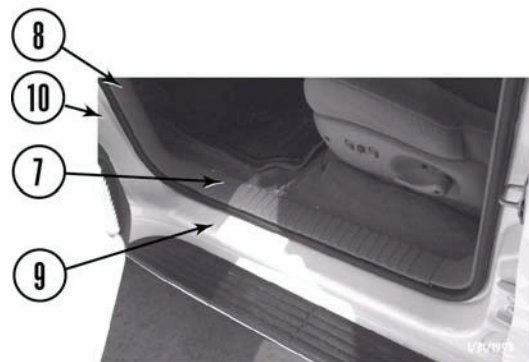
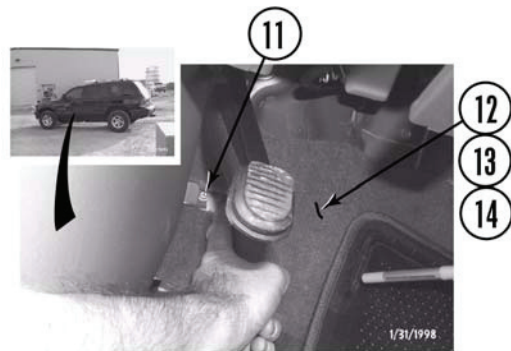
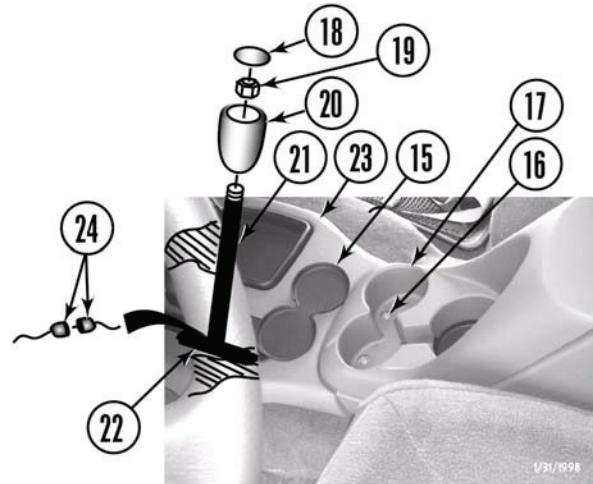
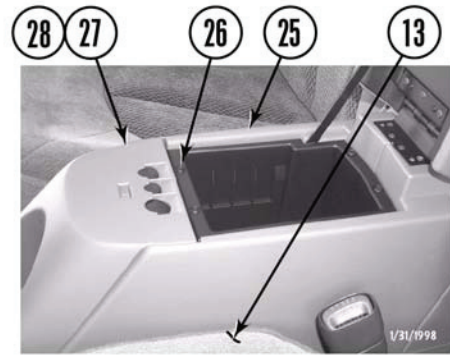

s. If removed, install skid plate (34) on the frame (35) with four bolts (33).

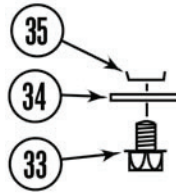

D. After installation is complete.

1. Install two airbag fuses (5) in the fuse box (6).
2. Install battery (4) and connect both battery cables. Be sure to reconnect the positive cable (3) first, then the negative cable (2).
3. Raise spare tire (1) all the way up to the original position.
4. Stick *kit* warning sticker on the dash in plain sight of all vehicle occupants.
5. Double check the vehicle.

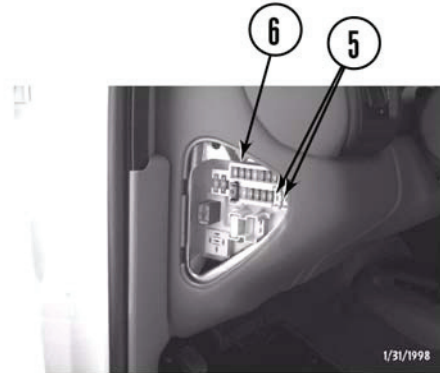

⚠CAUTION

Retorque all fasteners after 500 miles and after off road use. All body lift components should be visually inspected and fasteners retorqued during routine vehicle servicing.

- a. Check all mounting hardware to ensure it is properly tightened.
- b. Check all wires, hoses, cables, etc. to ensure they have been properly connected and there is ample slack. With the number of hoses on this vehicle, it is vital that this be checked thoroughly.
- c. Check vehicle electrical system.
- d. Start vehicle and check the steering in both directions to ensure that there is no bind. Check clutch operation. Check the operation of the brake system and the parking brake. Check both shift levers' operation. Ensure that there is proper engagement in all gears and 4 wheel drive ranges.

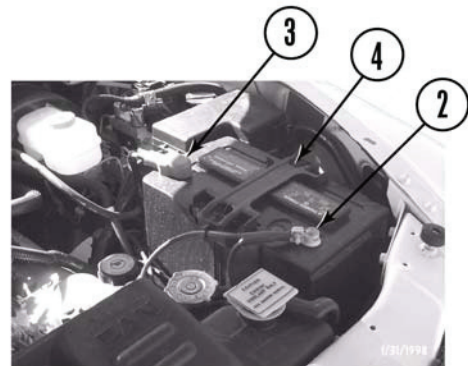

⚠CAUTION

Never open a closed cooling system after the vehicle has been started. Only fill the cooling system if the cap has been removed while the vehicle was still cold.

- e. Check coolant level. Fill coolant to the proper level (refer to the Owner's Manual).

f. Test drive vehicle in all gears and 4 wheel drive ranges. Pay close attention to all vehicle systems. Check all hardware again in 500 miles and as part of your regular maintenance schedule.

⚠CAUTION

Performance Accessories does not recommend any particular wheel and tire combinations for use with its body lifts and cannot assume responsibility for the customer's choice of wheels and tires. Reference your owner's manual for recommended tire sizes and warnings related to the use of oversized tires. Larger wheel and tire combinations increase stress and wear on steering and suspension components, which leads to increased maintenance and higher risk for component failure. Larger wheel and tire combinations also alter speedometer calibration, braking effectiveness, center of gravity, and handling characteristics. Consult with an experienced local off road shop to find what wheel and tire combinations work best with your vehicle.

⚠NOTE

All warranty information, instruction sheets, and other documents regarding the installation of this product must be retained by the vehicle owner. Information contained in the instructions and on the warranty card will be required for any warranty claims. The vehicle owner needs to understand the modifications made to his vehicle and how they affect vehicle handling and performance. Failure to provide the customer with this information can result in damage to the vehicle and severe personal injury.

E. Kit Parts List.

Quantity	Description
	Kit
12	3 x 3 blocks
2	Front inner bumper brackets
2	Front outer bumper brackets
2	Rear inner bumper brackets
2	Rear outer bumper brackets
1	Transmission cable bracket
1	1 1/8" x 5" fuel filler hose ext.
1	3/4" x 17" fuel vent hose
1	Warning to driver sticker
1	Logo sticker
1	6ml bottle Loctite
1	Bolt pack BP60053
12	12mm x 160mm bolts
12	7/16" USS washers
1	se 8700 steering extension
1	3/8" x 1 1/4" socket head bolt
1	Hardware pack HP60053
	Bolts
4	7/16" x 1 1/2" bolts
12	7/16" x 1" bolts
2	5/16" x 1" bolts
4	1/4" x 1" bolts
	Washers
32	7/16" USS washers
6	5/16" SAE washers
8	1/4" SAE washers
	Nuts
16	7/16" nylock nuts
2	5/16" nylock nuts
4	1/4" nylock nut
1	8mm nylock nut
	Miscellaneous
2	Brake line brackets
1	Transfer case linkage rod extension
1	Lower radiator hose extension
2	Ground strap extensions
2	#10 hose clamps
2	#28 hose clamps
2	#36 hose clamps
5	Zip ties



Front bumper inner bracket



Front bumper outer bracket



Rear bumper inner bracket



Rear bumper outer bracket