



**841 S. 71st Avenue • Phoenix, AZ 85043**  
**(623) 907-0081**  
**www.performanceaccessories.com**

**NISSAN TITAN**  
**3" BODY LIFT**  
**INSTALLATION INSTRUCTIONS**  
**2004-2009                      KIT # PA40053**

**⚠ WARNING**  
 Installation of a Performance Accessories body lift kit will change the vehicle's center of gravity and handling characteristics both on and off-road. You must drive the vehicle safely! Extreme care must be taken to prevent vehicle rollover or loss of control, which could result in serious injury or death. Avoid sudden sharp turns or abrupt maneuvers and always make sure all vehicle occupants have their seat belts fastened.

**⚠ WARNING**  
 Before you install this kit, read and understand all instructions, warnings, cautions, and notes in this instruction sheet and in the vehicle owner's manual.

**⚠ CAUTION**  
 Proper installation of this kit requires knowledge of the factory recommended procedures for removal and installation of original equipment components. We recommend that the factory shop manual and any special tools needed to service your vehicle be on hand during the installation. Installation of this kit without proper knowledge of the factory recommended procedures may affect the performance of these components and the safety of the vehicle. We strongly recommend that a certified mechanic familiar with the installation of similar components install this kit.

**⚠ WARNING**  
 DO NOT combine suspension, body, or other lift devices. Use of vehicle with combined lifts may result in unsafe and/or unexpected handling characteristics.

**⚠ WARNING**  
 This kit should only be installed on a vehicle that is in good working condition. Before you install the kit, thoroughly inspect the vehicle for corrosion or deformation of the sheet metal around the factory body mounts. If the vehicle is suspected to have been in a collision or misused, do not install this kit. Off-road use of your vehicle with this kit installed may increase the stress applied to the factory body mounts. We do not recommend that any vehicle with a body lift kit installed be involved in any extreme off-road maneuvers such as jumping. Failure to observe this warning may result in serious personal injury and/or severe damage to your vehicle.

**⚠ WARNING**  
 Many states and municipalities have laws restricting bumper heights and vehicle lifts. Consult state and local laws to determine if the changes you intend to make to the vehicle comply with the law.

**⚠ WARNING**  
 The installation of larger tires may reduce the effectiveness of the Braking System.

**⚠ WARNING**  
 Always wear eye protection when operating power tools.

**⚠ WARNING**  
 Before you install this kit, block the vehicle tires to prevent the vehicle from rolling.

**⚠ WARNING**  
 Accidental deployment of the air bag can result in serious personal injury or death. To avoid accidental deployment during installation of the kit, the Supplemental Restraint System (SRS, or airbag) must remain deactivated. Do not allow anyone near the airbag during installation. Refer to the factory service manual or owner's manual for the recommended procedure to disable the SRS. After you install the kit, reactivate the SRS before driving the vehicle.

**NOTE**  
 Performance Accessories recommends using the Loctite® supplied in the kit on the threads of all kit nuts and bolts unless specified otherwise in these instructions.

# Before Starting Installation

## NOTE

Kit parts are prefaced by the word *kit* and appear in **bold** print.

1. Carefully read all warnings and instructions completely before beginning.
2. Verify all parts have been received in this kit by checking the parts list at the end of this document.

## NOTE

If parts are missing from kit, please be prepared to provide the following information:

1. **Name** of purchase location
  2. **Bar Code** on side of box
  3. **Date** above bar code
  4. **Date** inside box cover
  5. **Inspector #** from inside box cover
3. **Only install this kit on the vehicle for which it is specified.** If anytime during the installation you encounter something different from what is outlined in the instructions, call technical support at (928) 636-7080.
  4. Special tools needed:
    - a. Die grinder or similar tool capable of cutting metal
    - b. Welder or access to a professional welding shop.
  5. Park the vehicle on a clean, dry, flat, level surface and block the tires so the vehicle cannot roll in either direction.

# Engine Compartment

1. Battery cables
  - a. Disconnect both battery cables. Disconnect negative cable first, then positive cable.

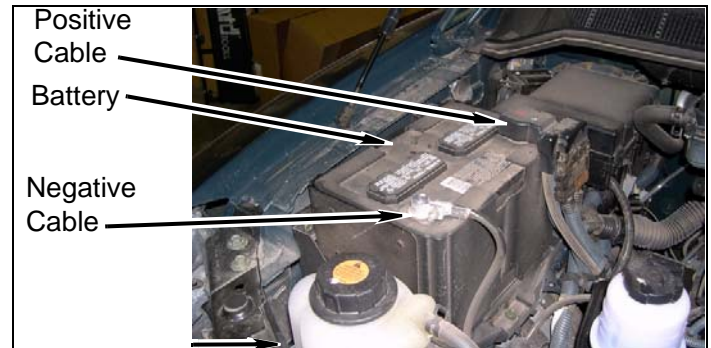

# Measurements

1. Measure and record distance between front bumper and fenders.  
Driver Side \_\_\_\_ Passenger Side \_\_\_\_
2. Measure and record distance between rear bumper and bed.  
Driver Side \_\_\_\_ Passenger Side \_\_\_\_
3. Measure and record distance between cab and bed.  
Driver Side \_\_\_\_ Passenger Side \_\_\_\_

# Inside Cab

1. Airbag fuse

## NOTE

The location of the airbag fuse may vary; check the owner's manual.

- a. Remove fuse cover.

b. Remove airbag fuse.

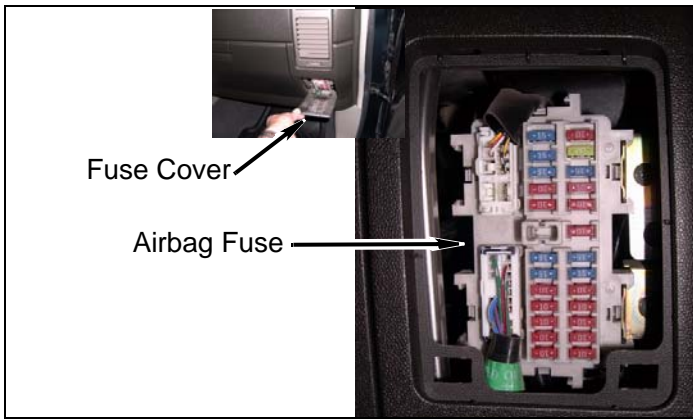

b. Remove four bolts and skid plate from frame and vehicle.



c. If equipped, remove four bolts and two tow hooks from frame.

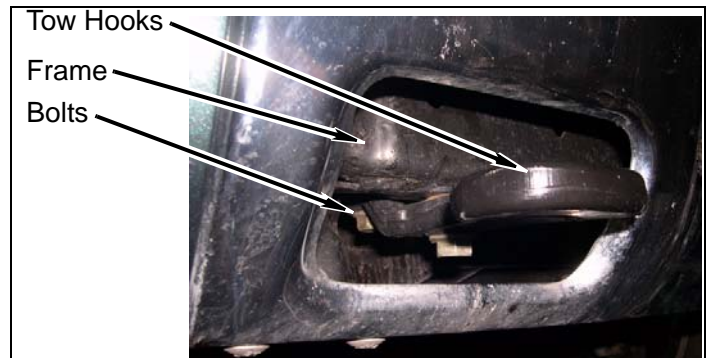

d. Remove four bolts and two side impact braces from frame.

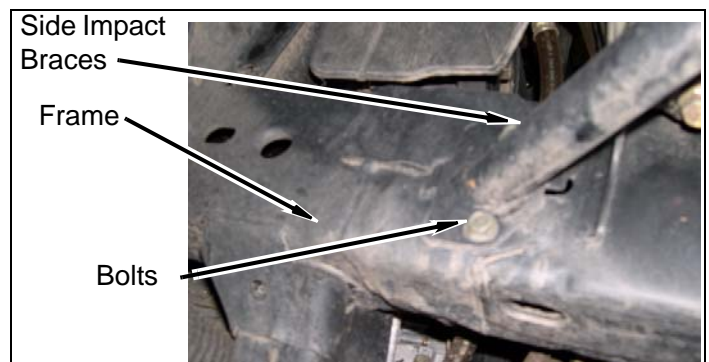

e. Remove four nuts and two side impact braces from front bumper.

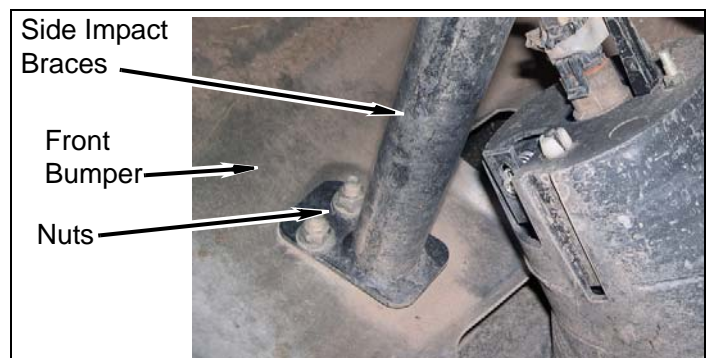

**⚠ WARNING**

Accidental deployment of the air bag can result in serious personal injury or death. To avoid accidental deployment during installation of the lift kit, the Supplemental Restraint System (SRS, or airbag) must remain deactivated. Do not allow anyone near the airbag during installation. Refer to the factory service manual or owner's manual for the recommended procedure to disable the SRS. After kit installation, the SRS must be reactivated before driving the vehicle.

**⚠ CAUTION**

If the following step is not performed, the airbag clockspring could be damaged. Do not turn the steering wheel while the steering shaft is disconnected.

c. Strap steering wheel to prevent accidental movement.

## Prepare to Install Kit

### Front of vehicle

1. **SE & LE models:** Front bumper

a. If equipped, remove two wiring harness connectors from running lights.





f. Remove grill from core support and vehicle by releasing eight grill turn clips.

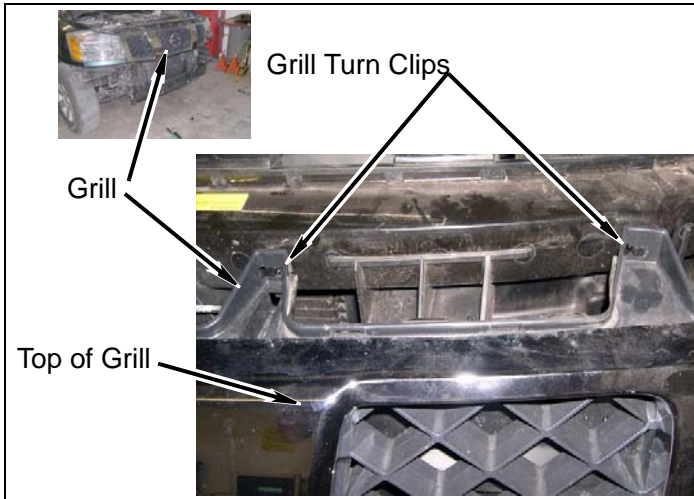

g. Remove six bolts and front bumper from front bumper brackets and vehicle.

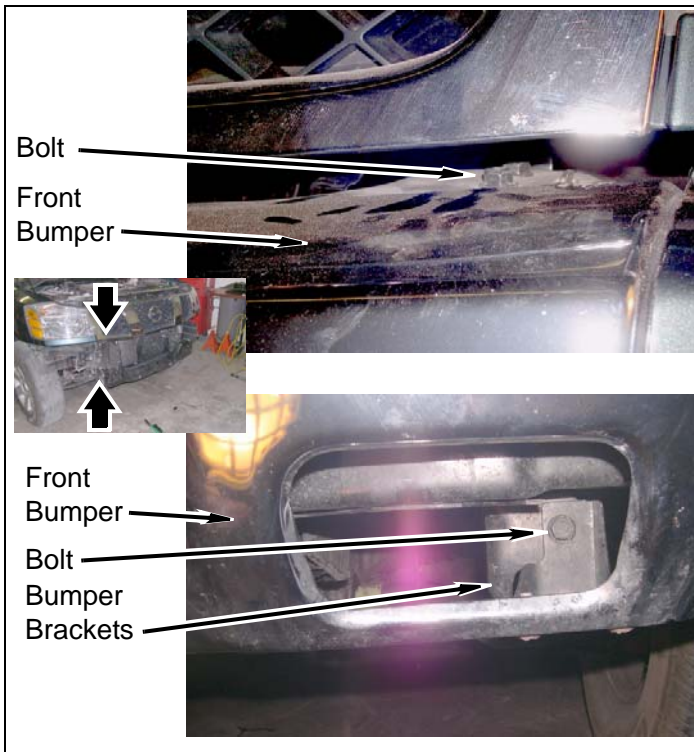

2. **XE models:** Front bumper

a. Remove eight turn clips and grill from vehicle.

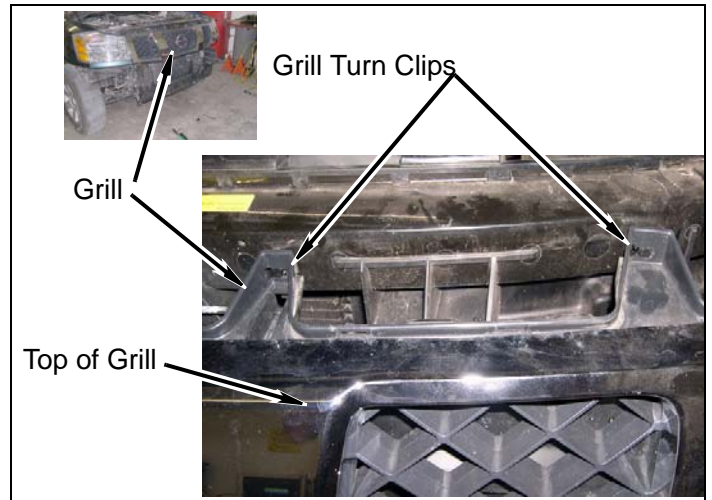

b. Remove two screws and three pop-up clips from front bumper fascia and skid plate.

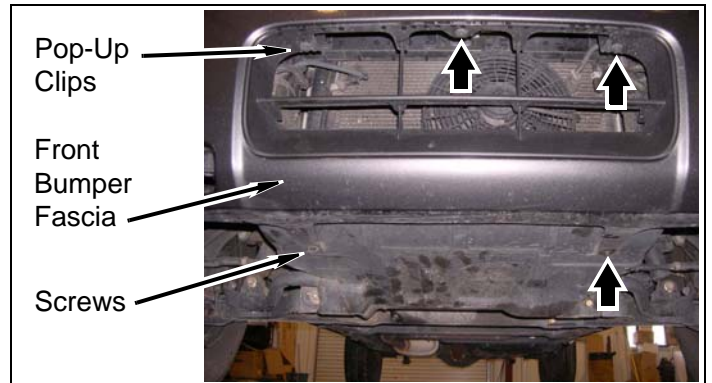

c. Remove six screws from driver and passenger front bumper fascia and wheel wells.



d. Pull driver and passenger wheel well back and remove four bolts from front bumper fascia and front fenders.

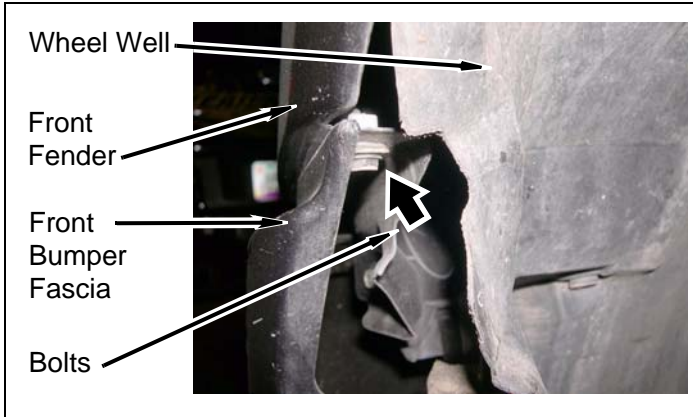

e. Remove six bolts and front bumper fascia from vehicle.

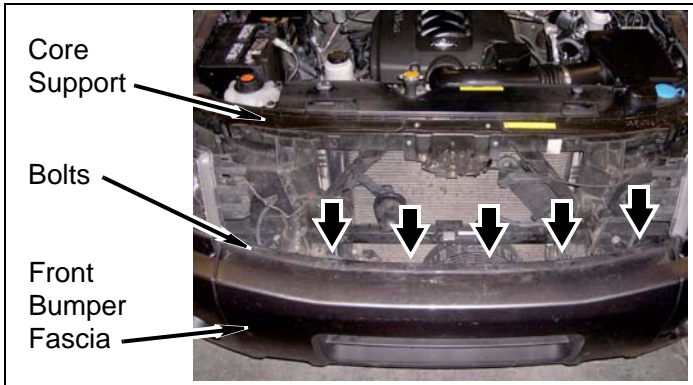

f. Remove two clips and foam support from front bumper.

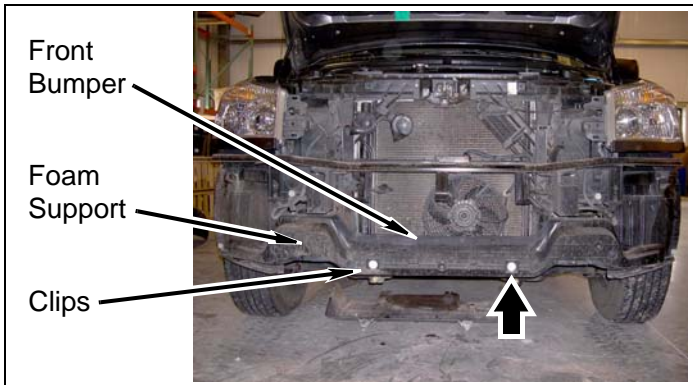

g. Remove six bolts, four nuts, and two side bumper braces from front bumper and side impact braces.

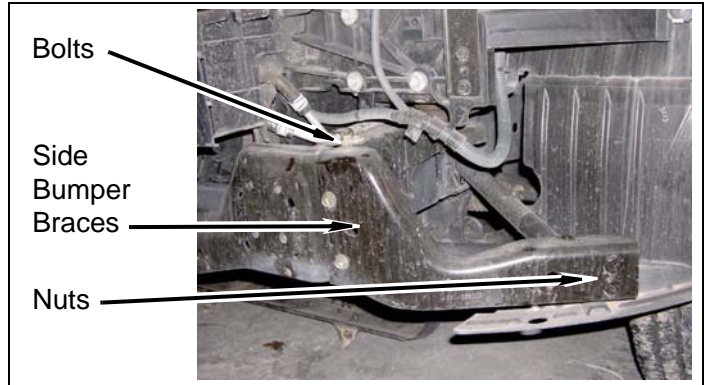

h. Remove four bolts and two side impact braces from frame.

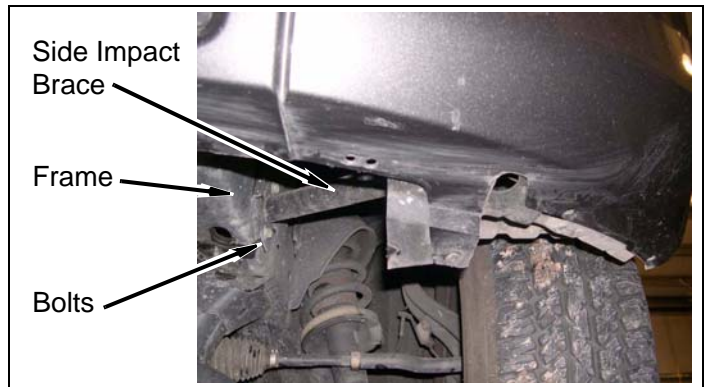

i. Remove four bolts and skid plate from frame and vehicle.





# Engine Compartment

## 1. Lower radiator

- a. Remove hose clip and metal transmission cooler hose from fan shroud.

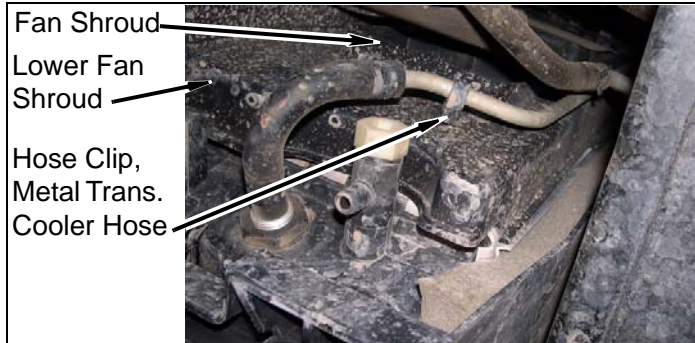

- b. Remove transmission cooler hose and lower fan shroud from fan shroud and vehicle.



- c. Drain cooling system into a clean container according to manufacturers specifications.

## 2. Air handling system

- a. Remove push clip, wire harness and wire harness connector from air cleaner cover.

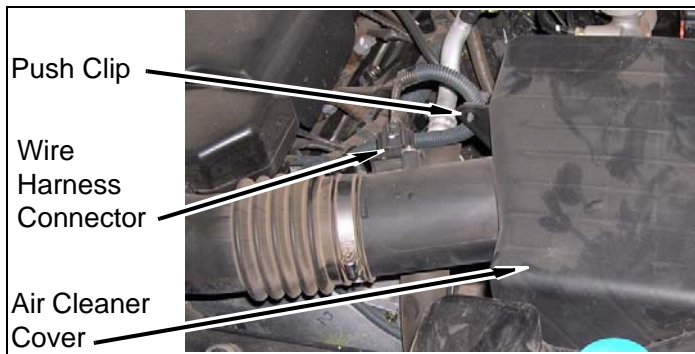

- b. Remove two clips, hose clamp, and air cleaner cover from air cleaner base.

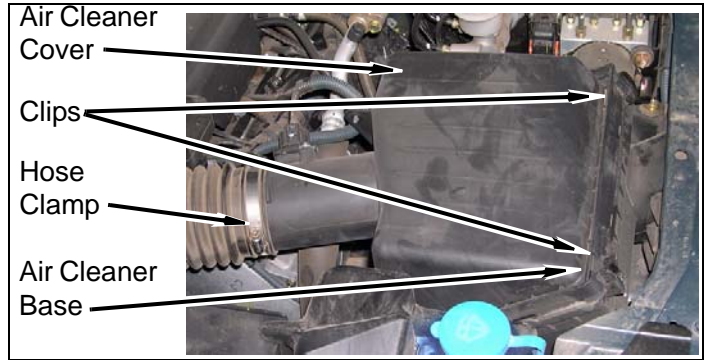

- c. Remove two bolts and intake cover from engine.

- d. Remove hose clamp and air intake hose from engine. Position intake hose to the side.

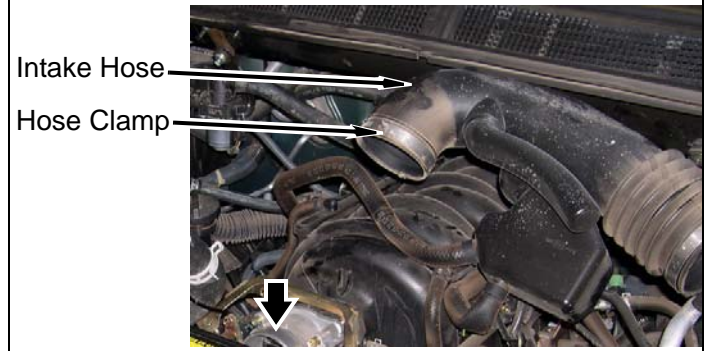
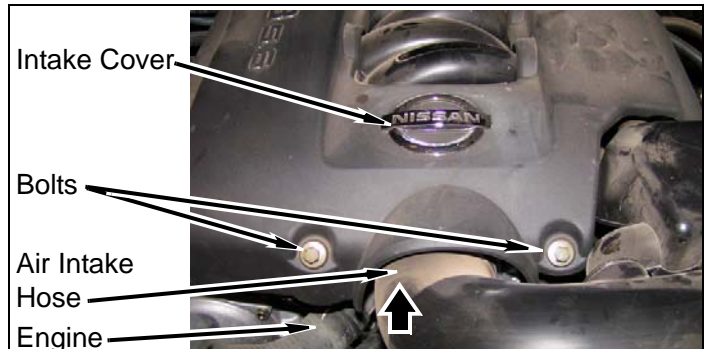

- e. Remove axle vent hose, and axle vent hose clip from air cleaner base.

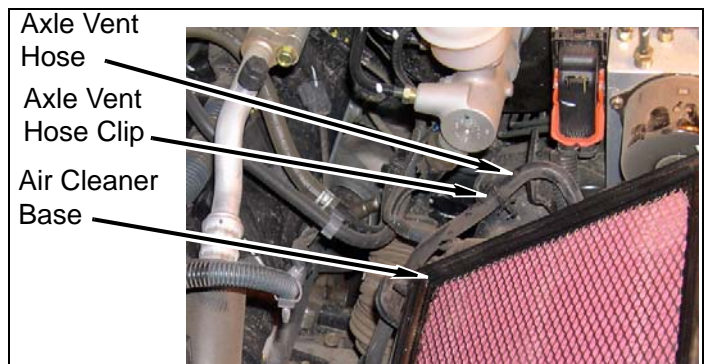

3. Radiator fan shroud

- a. Remove hose clamp and upper radiator hose from radiator. Zip-tie upper radiator hose to engine bracket.

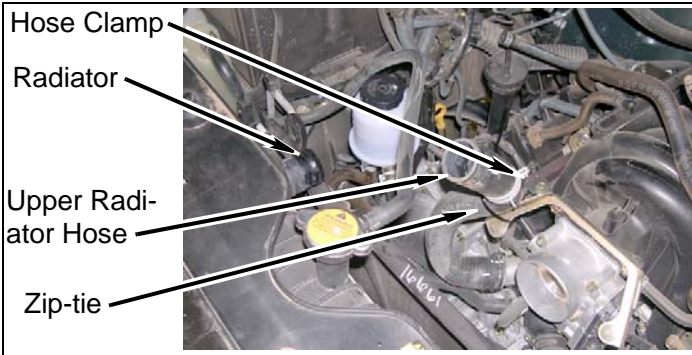

- b. Remove three hoses from two fan shroud clips.

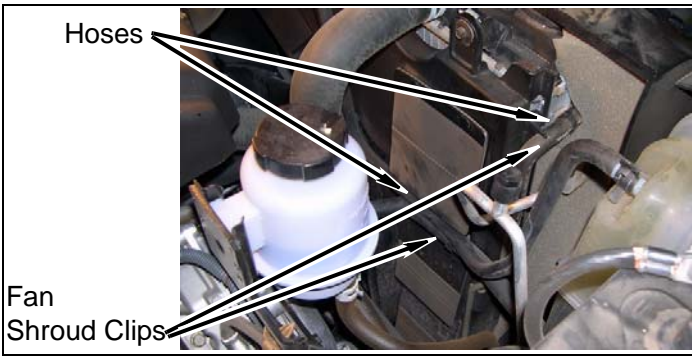

- c. Remove two bolts and fan shroud from radiator. Lift and remove fan shroud from vehicle.

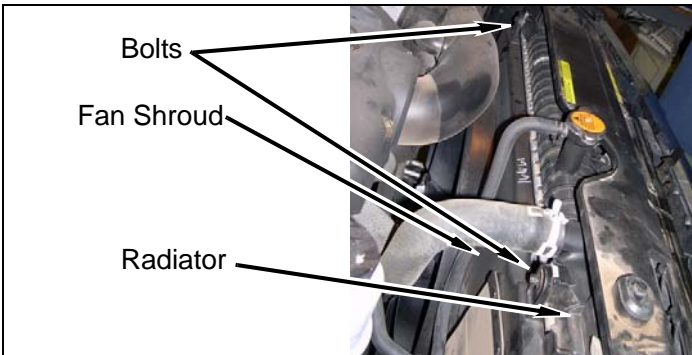

- d. Remove four nuts and fan clutch assembly from fan pulley and vehicle. Install nuts on fan pulley.

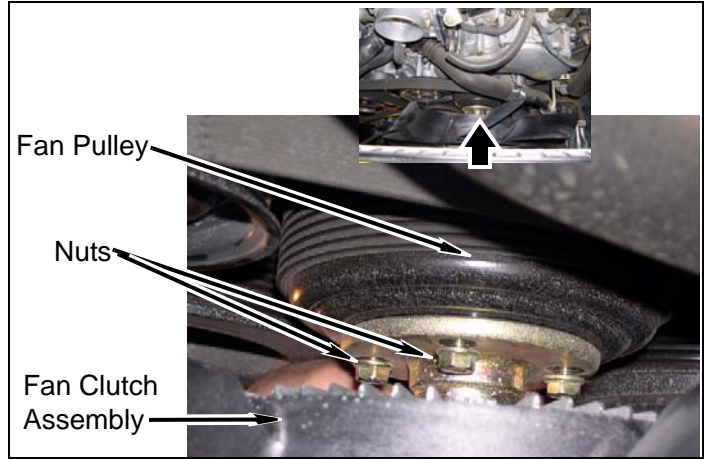

4. Radiator

- a. Remove two shoulder bolts from radiator and core support.



5. Inner fender well passenger side

- a. Remove two clips from wiring harness.
- b. Remove AC line from clip on inner fender.

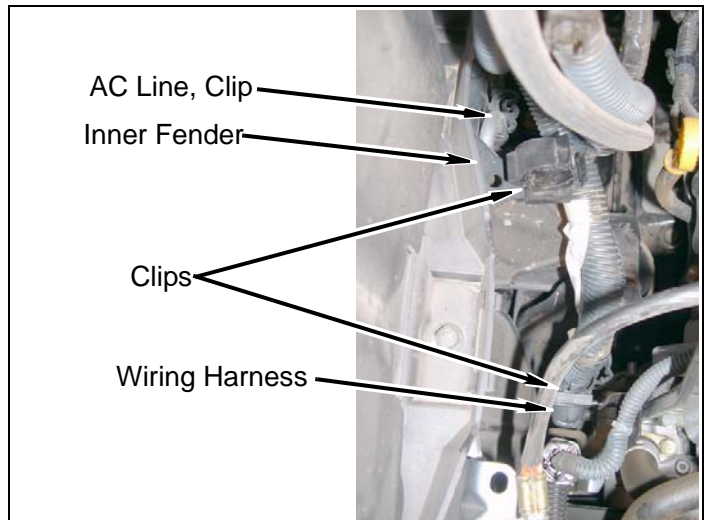



- c. Remove two bolts and transmission cooler line brackets from frame.

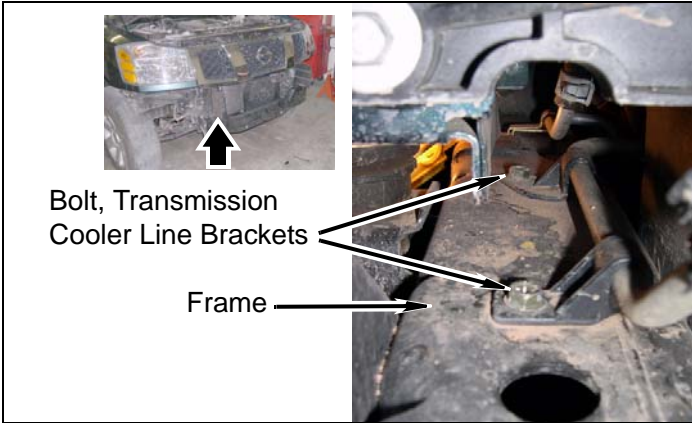

- d. Remove clip and wiring harness from frame.

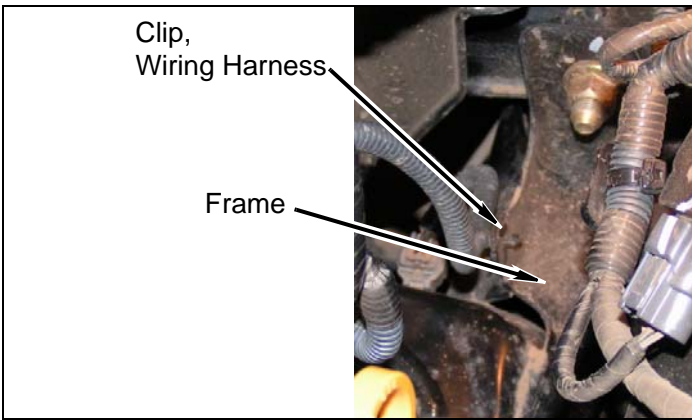

6. Fire wall

- a. Remove nut and AC selector valve from fire wall.

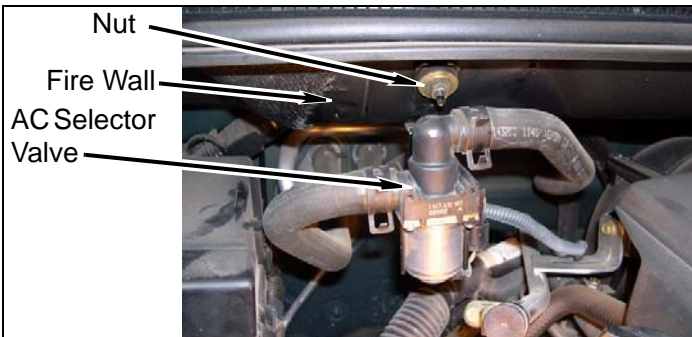

- b. Remove nut and AC line bracket from fire wall.



7. Inner fender well driver side

- a. Remove two bolts and power steering cooler lines from frame.

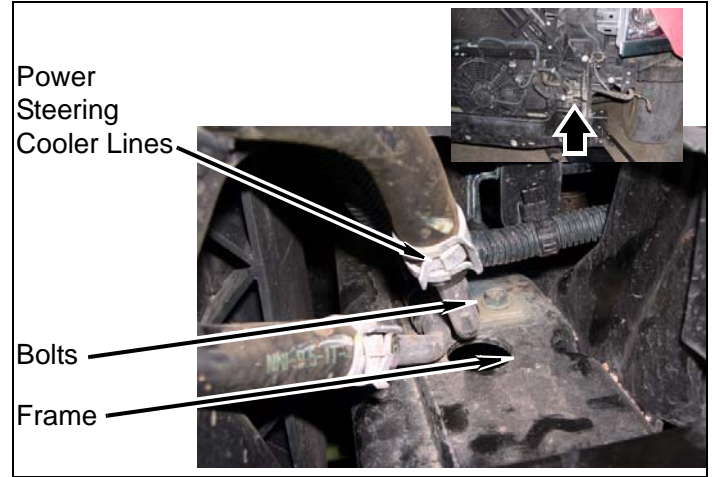

- b. Remove clip and wiring harness from frame.

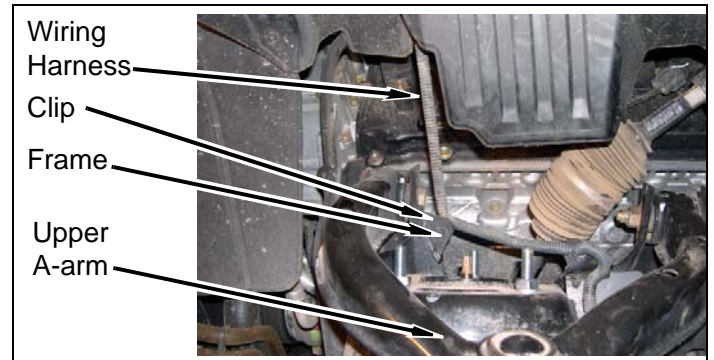

8. Steering shaft

- a. Mark lower steering shaft and rack and pinion as shown. Remove bolt and lower steering shaft from rack and pinion.

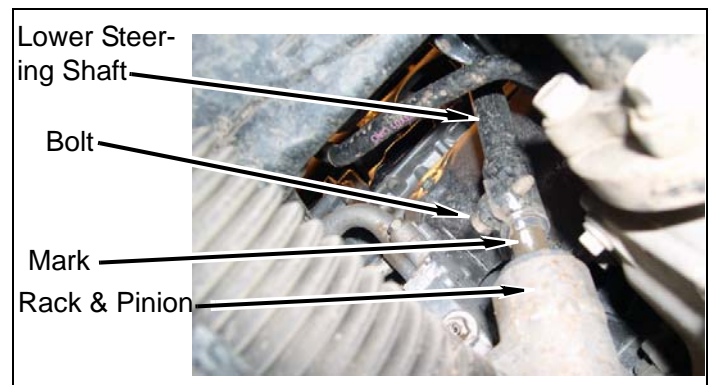



9. Fuel lines at the fire wall

- a. Remove two nuts and fuel / brake line bracket, from fire wall.

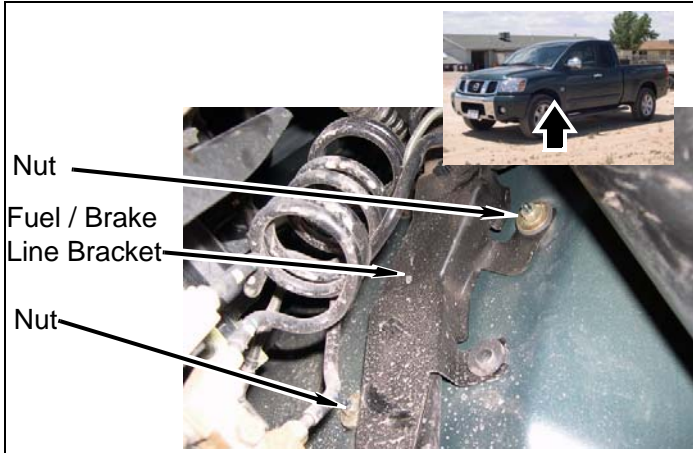

- b. Reposition catalytic converter ground strap on body so end link connector is pointing forward.

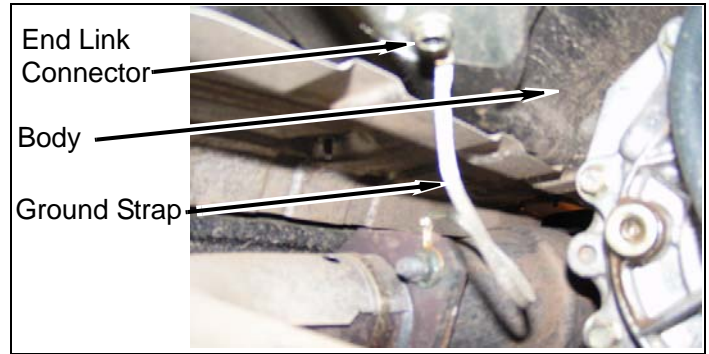

3. Side step passenger side

- a. Remove six bolts and side step from three side step brackets.

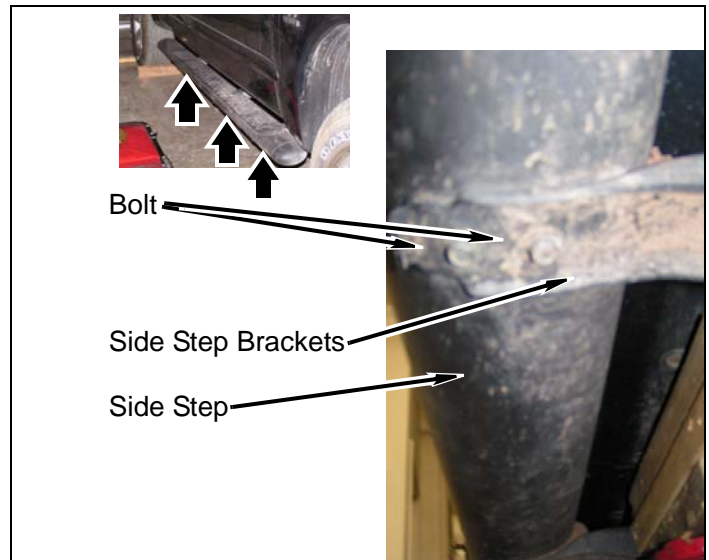

**Frame**

1. Side step driver side

- a. Remove six bolts and side step from three side step brackets.

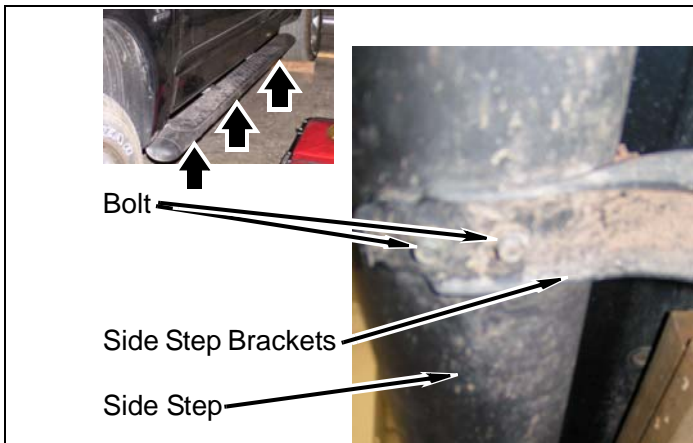

4. Frame rail passenger side

- a. Remove plastic cover from wiring harness bracket.



2. Drive line hoop

- a. Remove four bolts and drive line hoop from vehicle.

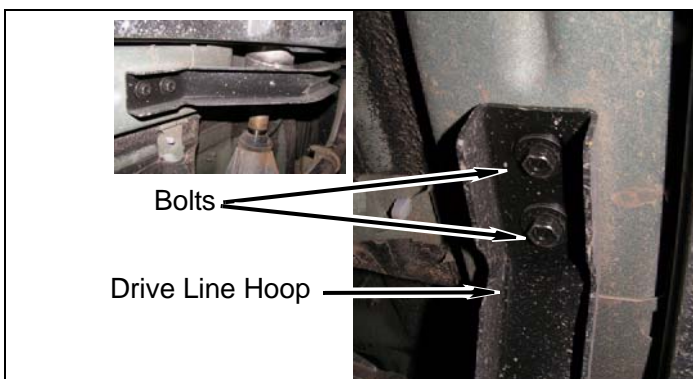

- b. Remove bolt and wiring harness bracket from frame.



- c. Remove two wiring harness push clips and wiring harness from frame / body mount perch.

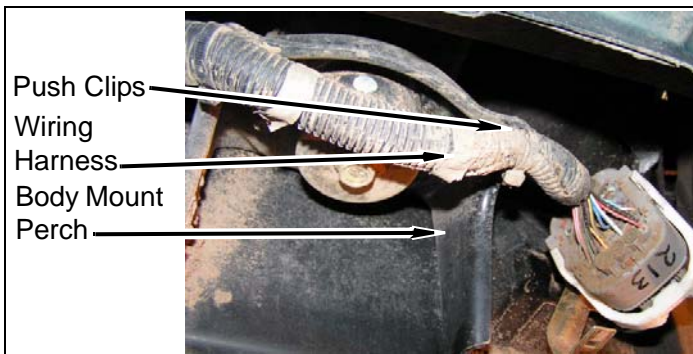

**Rear of Vehicle**

- 1. Fuel filler

**⚠ WARNING**  
 Use extreme caution when working near fuel lines and fuel tank. Clean up spilled fuel immediately. A spark could cause an explosion or fire resulting in serious personal injury and property damage.

- a. Remove bolt and fuel filler bracket from bed.

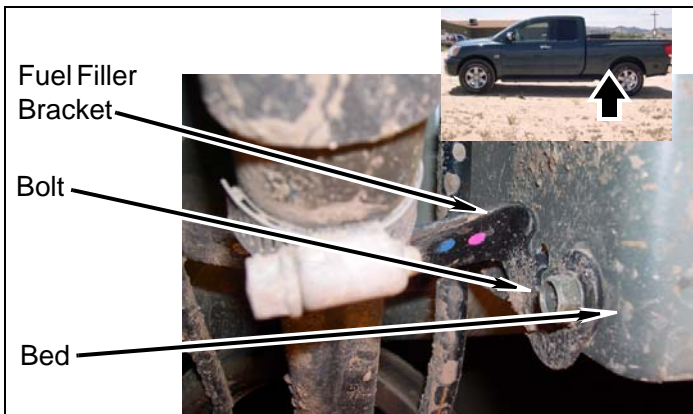

- b. Remove fuel cap from fuel filler. Push fuel filler rubber gasket and fuel filler toward inside of bed.

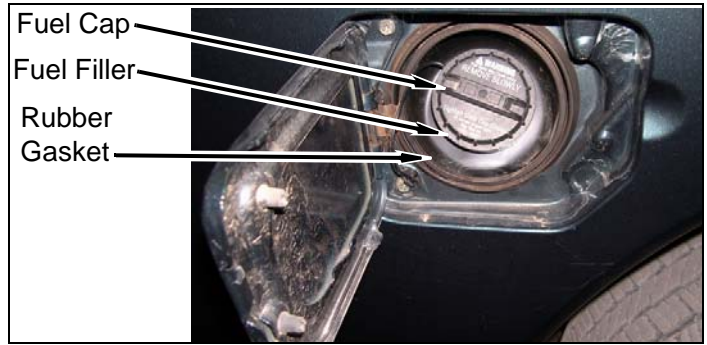

- 2. Spare tire cranking mechanism

- a. Lower the spare tire according to the manufacturer's specifications.
- b. Remove three push clips and plastic housing from frame cross member.
- c. Remove two bolts and spare tire winch mechanism from frame cross member.

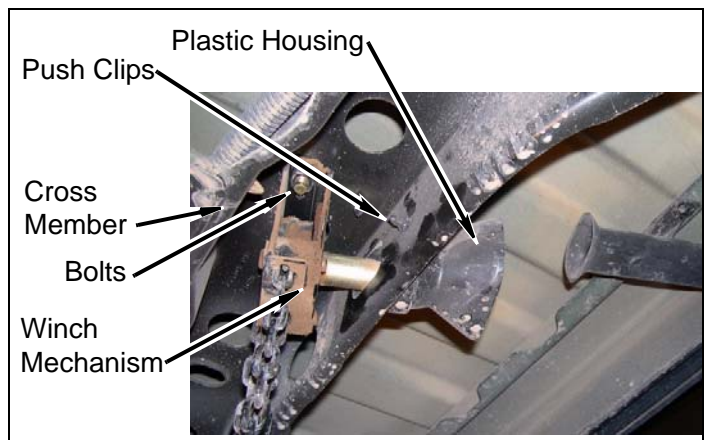

- 3. Rear bumper wiring driver side

- a. Remove wiring harness and clip from bumper.

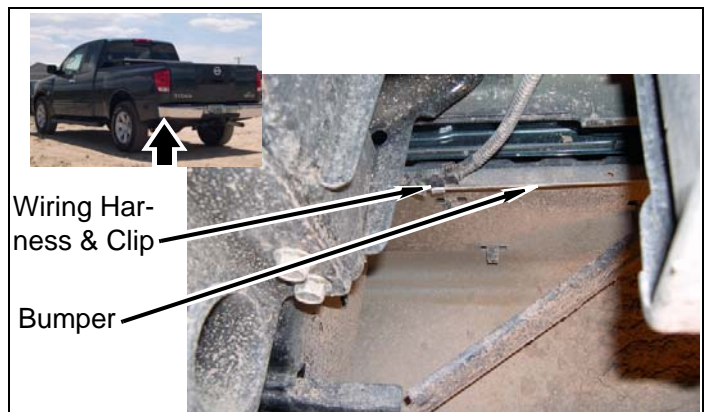



- b. Remove three wiring harness push clips from rear bumper bracket.

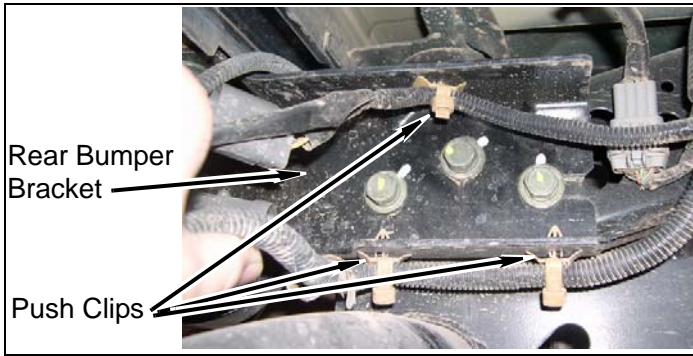

- c. Disconnect two wiring harness connectors from wiring harness.



- d. Remove two license plate light connectors from rear bumper.

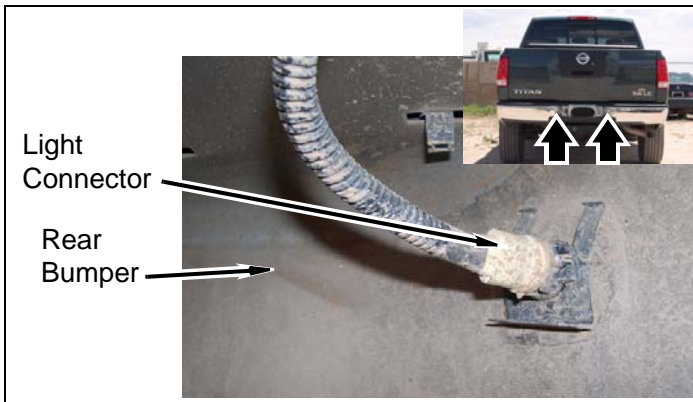

#### 4. Rear bumper passenger side

- a. Remove wiring harness connector push clip from frame.



- b. Remove six bolts and rear bumper from frame.



## Install Kit

### Cab

- 1. Prepare to lift cab from frame

- a. Loosen, but DO NOT remove, three cab mounting bolts on driver side.

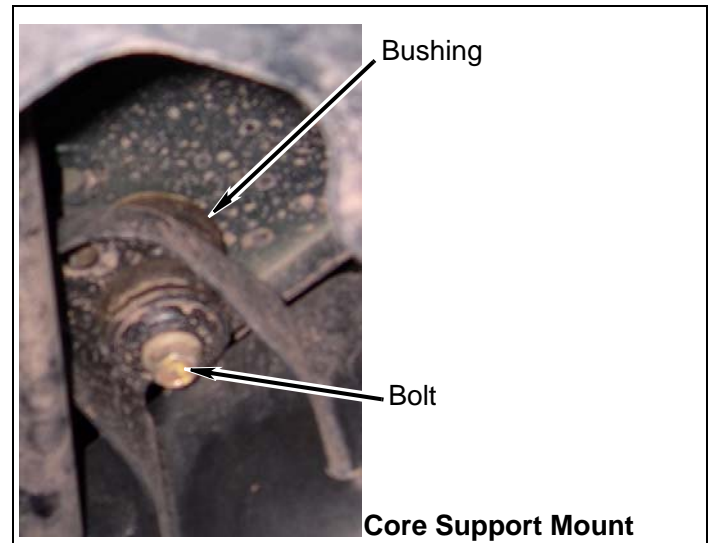

- b. Remove three bolts from cab bushings on passenger side.

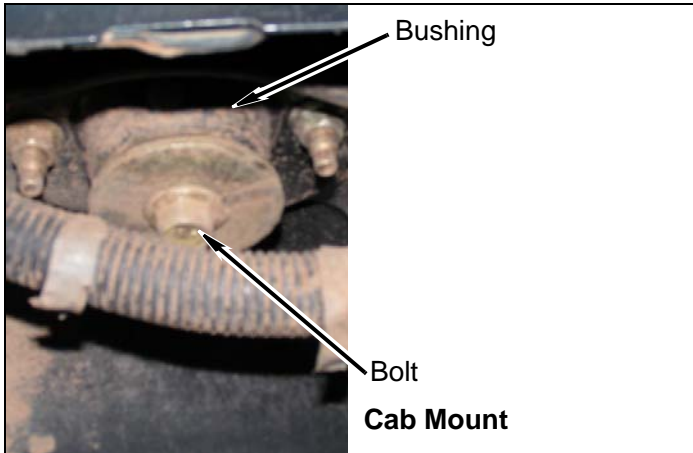

- c. Install a kit **bolt** (M12-1.25 x 180mm) on each cab mount. DO NOT tighten.

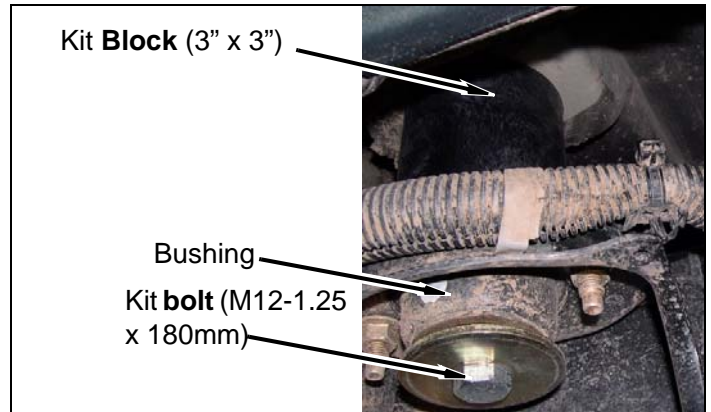

- d. Lower cab onto kit **blocks** (3" x 3").

**⚠ WARNING**

Use extreme caution when lifting body from frame. To prevent serious personal injury, ensure the hydraulic jack is securely placed. Keep your hands out from between the body and frame.

**⚠ CAUTION**

Continually check hoses, wires, lines, etc. to be sure that everything is flexing properly and not binding, or damage to the vehicle could result. Be especially careful of the a/c hoses at the fire wall, the belt pulley, and at the core support. Ensure brake lines stretch while lifting. Bending the lines to gain ample slack may be necessary. Be extremely careful not to kink the lines.

3. Cab driver side

- a. Repeat previous steps on driver side of cab.
- b. Check cab-to-bed spacing according to previous measurement.
- c. Remove each kit **bolt**, one at a time, and apply a few drops of Loctite® to threads and install kit **bolt** (M12-1.25 x 180mm). Tighten kit **bolts** to 45 ft. lbs.

2. Cab passenger side

- a. Using a hydraulic jack and a wooden block, slowly lift passenger side of cab a little more than 3".

**⚠ CAUTION**

The kit **blocks** must be installed in addition to the factory bushings. Installing the kit **blocks** without the factory bushings could result in damage to the vehicle or serious personal injury.

- b. Install a kit **block** (3" x 2") on the core support bushings and two kit **blocks** (3" x 3") on bushings on each cab mount bushings.

**Bed**

1. Prepare to lift bed from frame

- a. Loosen, but DO NOT remove, bed mounting bolts on driver side.

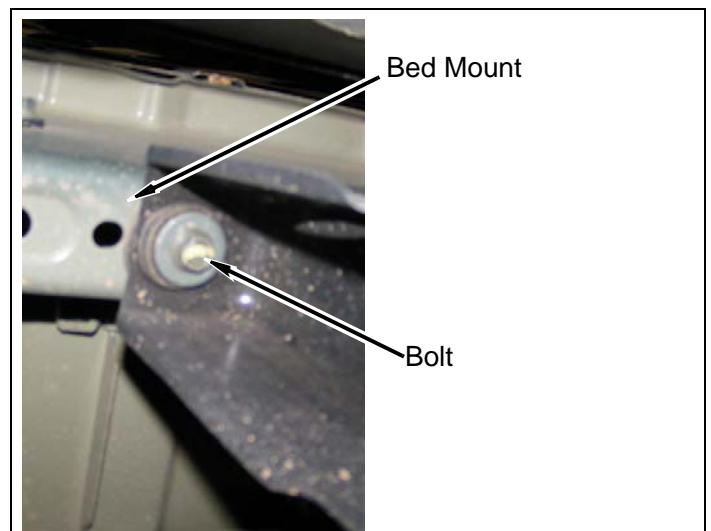



2. Remove three bolts, washers, and small bushing from three bed mounts on passenger side.

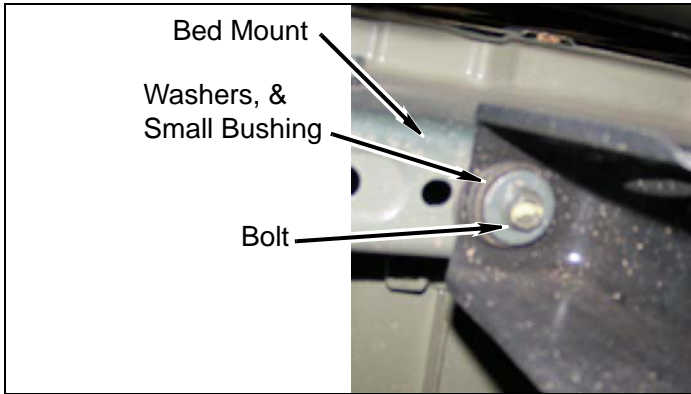

- d. Check bed-to-cab spacing according to previous measurement.
- e. Remove each kit **bolt**, one at a time. Apply a few drops of Loctite® to threads and install kit **bolt**, washer, and small bushing. Tighten kit **bolt** to 45 ft. lbs.

## Rear of Vehicle

1. Rear bumper

**⚠ WARNING**

The following procedure is intended only to enhance the appearance of the vehicle. The rear bumper will no longer be rated for towing of any kind. Towing with the rear bumper after it has been lifted can result in death, serious personal injury, or damage to the vehicle. Towing after the bumper has been lifted should be accomplished using a rated Class III receiver type hitch.

**⚠ WARNING**

Use extreme caution when lifting the bed from the frame. To prevent serious personal injury, ensure the hydraulic jack is securely placed. Keep your hands out from between the bed and frame.

**⚠ CAUTION**

To prevent damage to the vehicle while lifting the bed, continually check hoses, wires, brake lines, etc. to ensure everything is flexing properly and not binding. Ensure clearance between bed and cab is maintained.

- a. Measure and mark a line 3-3/8" from top of the bumper brackets down the flat side as shown.

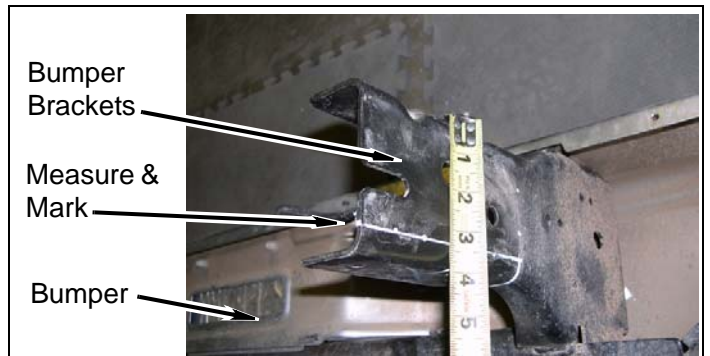

3. Bed passenger side

- a. Using a hydraulic jack and a wooden block, slowly lift passenger side of bed a little more than 3". Install three kit **blocks** (3" x 3") on three frame mounts and bed with three kit **bolts** (M10-1.25 x 120mm), kit **washers** (7/16" USS), and small bushings. DO NOT tighten.

- b. Measure and mark a line 6" back from the front of the bumper brackets as shown.

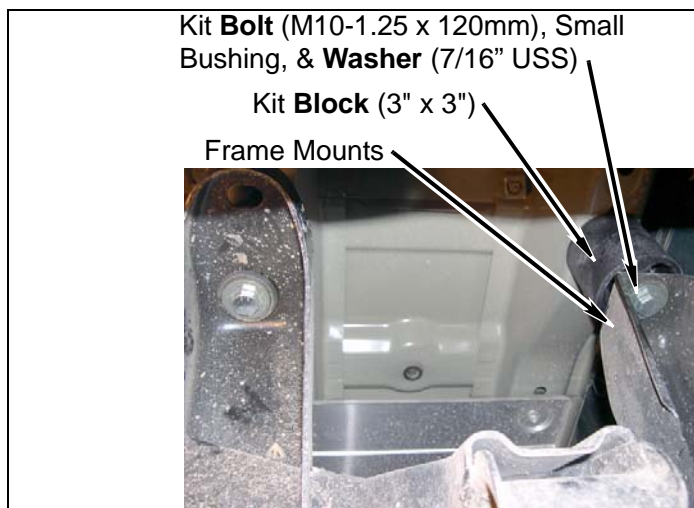
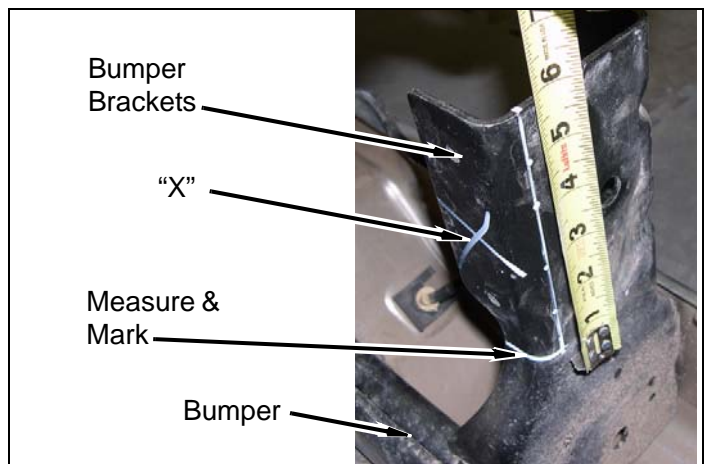

- b. Lower bed onto kit **blocks**.
- c. Repeat previous steps on driver side of bed.

- c. Cut and remove area of rear bumper brackets marked with an "X" where shown.

- d. Position kit **brackets, rear bumper** on bumper brackets ensure that cutting allows brackets to fit flush together.
- e. Remove four squeeze clips and center bumper cover from rear bumper.

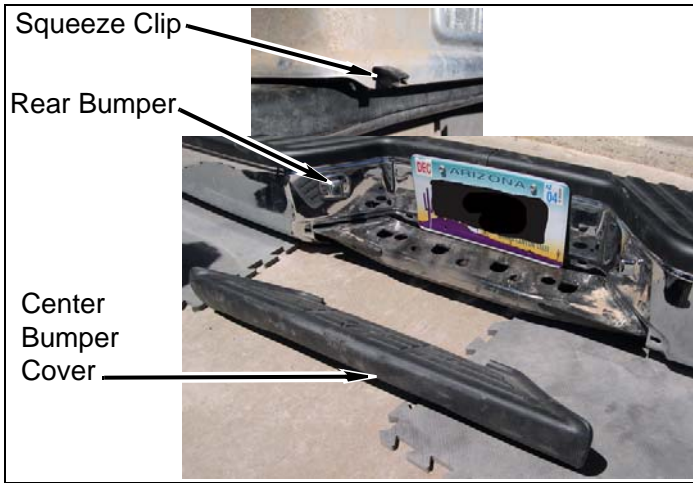

- f. Install kit **brackets, rear bumper** on bumper brackets with six kit **bolts** (7/16" x 1-1/2"), twelve kit **washers** (7/16" USS), and six kit **nuts** (7/16" nylock). Do not tighten.
- g. Install rear bumper and kit **bracket, rear bumper** on frame with six bolts. Do not tighten.

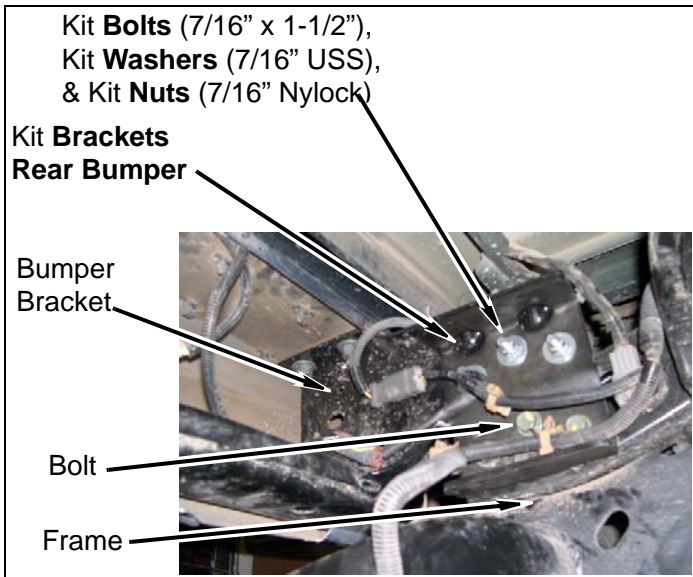

- h. Install kit **bracket, hitch support** on hitch and rear bumper with four kit **bolts** (7/16" x 1-1/2"), eight kit **washers** (7/16" SAE), and four kit **nuts** (7/16" nylock).

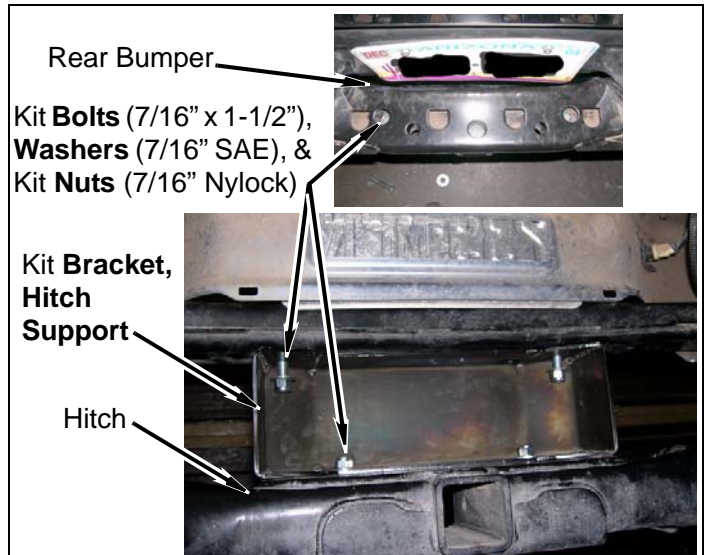

- i. Check measurements taken earlier and tighten all bumper and bumper bracket bolts.
- j. Install center bumper cover on rear bumper with four squeeze clips.

## 2. Rear bumper wiring

- a. Install wiring harness on bumper.

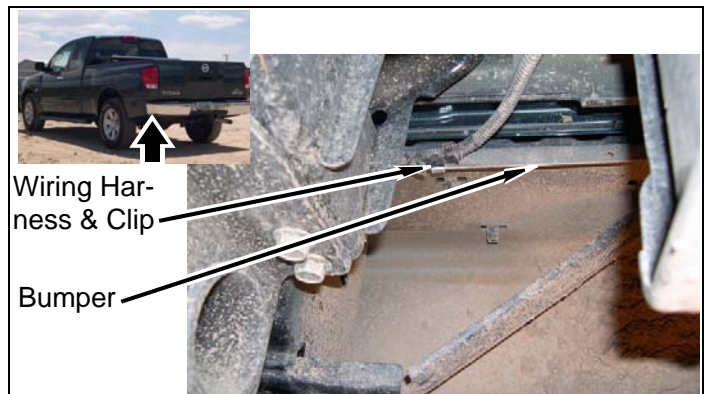



- b. Install and connect two wiring harness connectors on rear bumper and wiring harness.

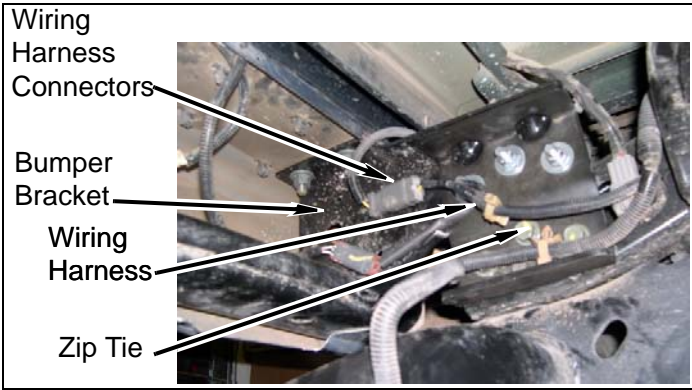

- c. Install kit zip-tie on wiring harness.

### 3. Spare tire winch mechanism

- a. Remove cotter key, U-bracket, plate, spring, and bell-bracket from chain and winch mechanism.

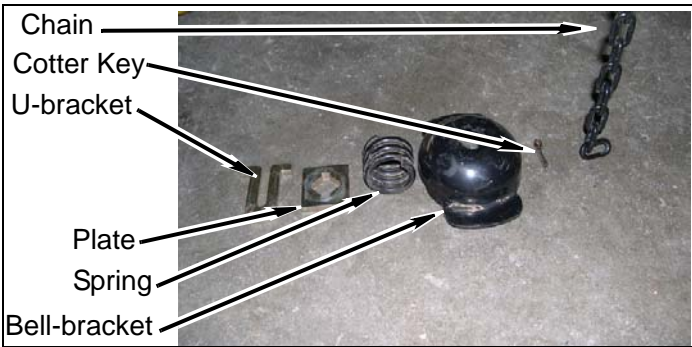

- b. Position chain through, and position winch mechanism on top of frame cross member with kit bolt (M10-1.25 X 100mm) and kit tube spacer. Do not tighten. Mark where chain contacts frame cross member and remove winch mechanismism.

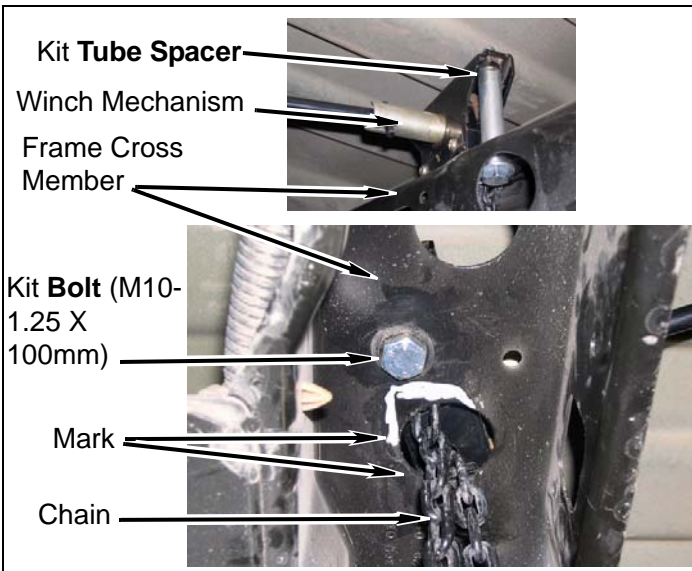

- c. Trim frame cross member as shown.

- d. Install chain through, and position crank mechanism on top of frame cross member with two kit bolts (M10-1.25 X 100mm), kit washers (7/16" SAE), and kit tube spacers. Ensure crank mechanism and chain operates correctly through frame cross member.

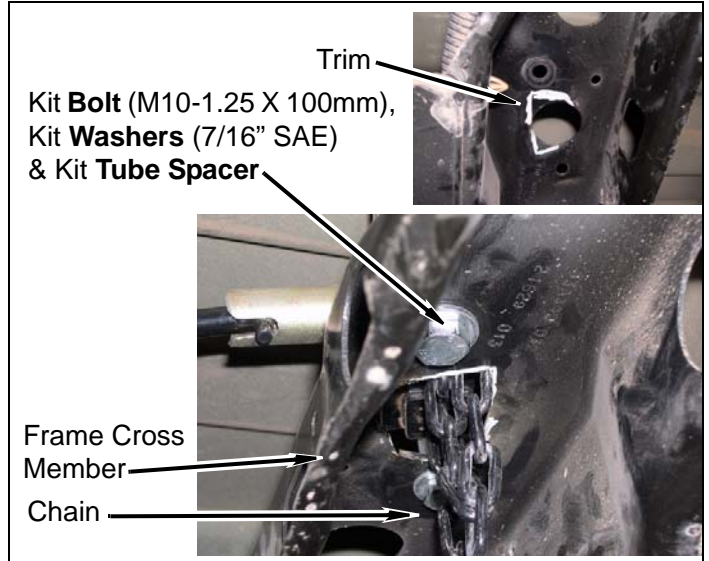

- e. Install bell-bracket, spring, plate, U-bracket, and cotter key on chain and winch mechanism.

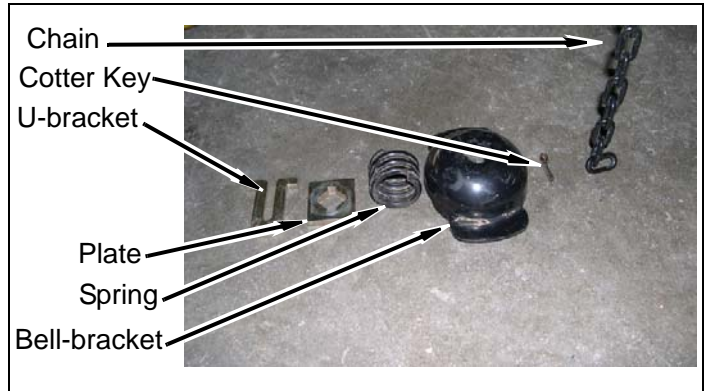

- f. Install spare tire according to owners manual. Ensure chain operates without catching on frame cross member.

### 4. Fuel filler

**⚠ WARNING**

Use extreme caution when working near the fuel lines and the fuel tank. Clean up spilled fuel immediately. A spark could cause an explosion or fire resulting in serious personal injury and property damage.

- a. Push fuel filler rubber gasket and fuel filler onto bed.

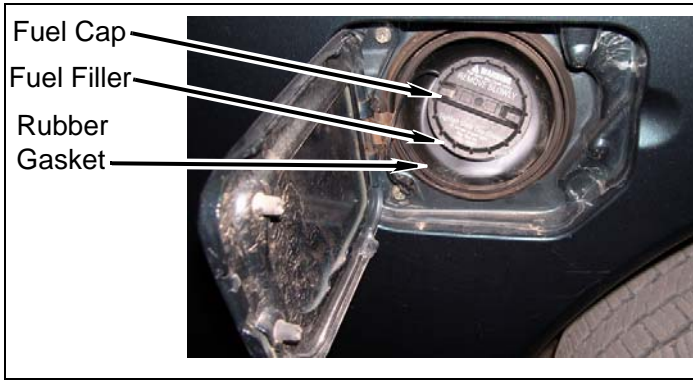

- b. Install fuel filler bracket on bed with bolt.

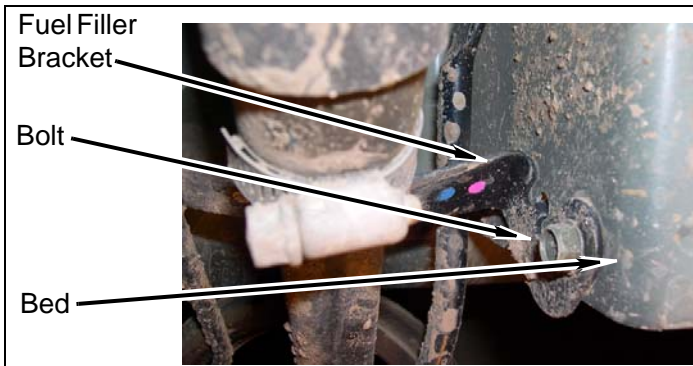

- c. Install kit **cut hose** on canister hose with kit **zip-tie**.

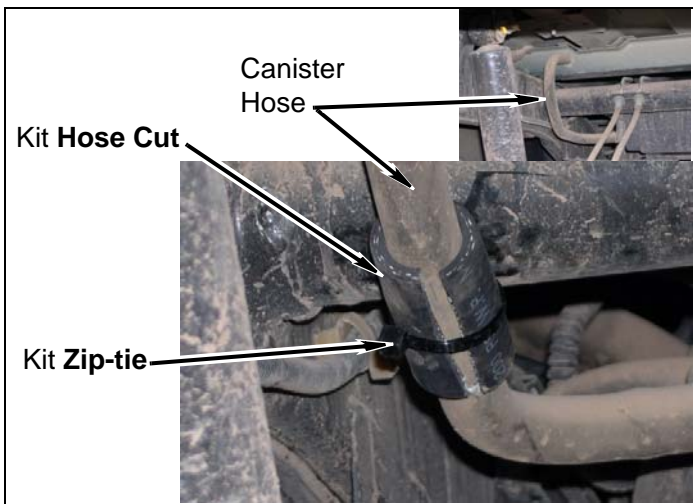

- d. Install fuel cap on fuel filler.

## Frame

- 1. Side step driver side

- a. Install side step on three side step brackets with six bolts.

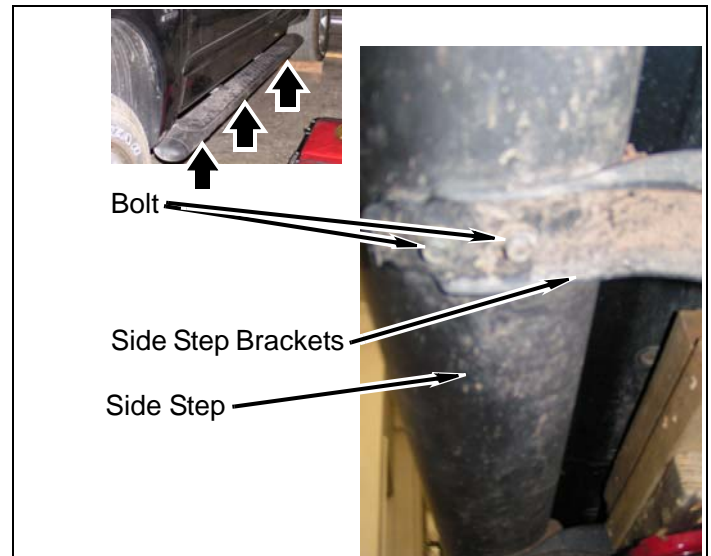

- 2. Drive line hoop

- a. Install four kit **bracket, spacers** on the body with four bolts.
- b. Install drive line hoop on four kit **bracket, spacers** with four kit **bolts** (3/8" X 1"), eight kit **washers** (3/8 USS), and four kit **nut** (3/8" nylock).

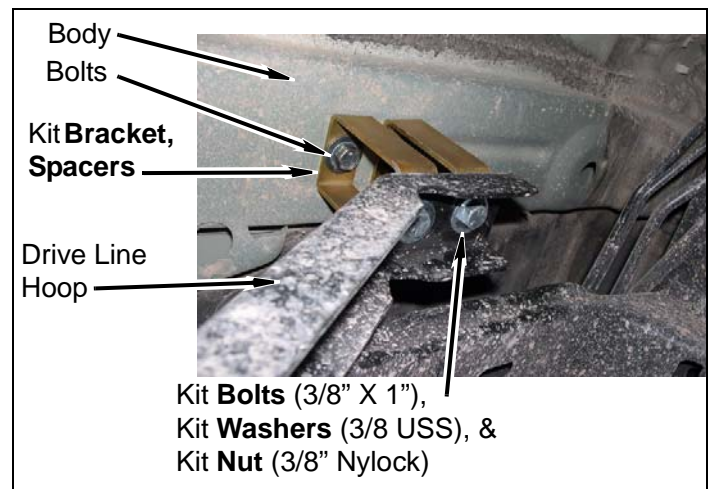



3. Side step passenger side

- a. Install side step on three side step brackets with six bolts.

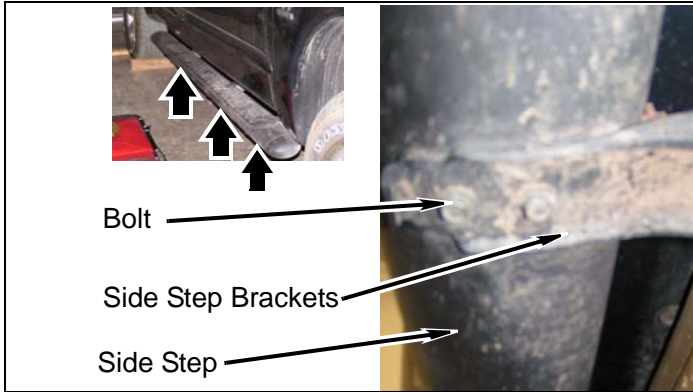

- b. Install wiring harness bracket and kit **bracket, L-shaped** on frame with bolt.

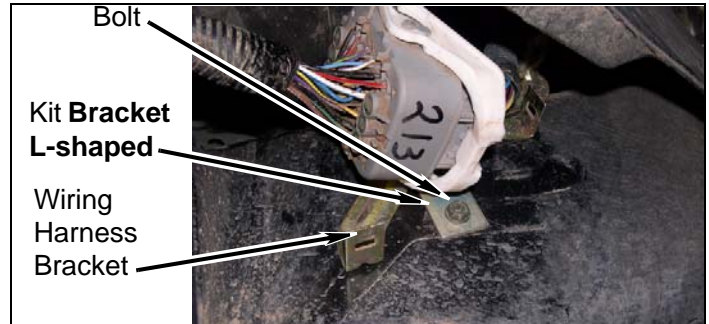

- c. Install plastic cover on wiring harness bracket.
- d. Install two wiring harness push clips and wiring harness on top of frame / body mount perch.



4. Frame rail passenger side

- a. Enlarge hole in wiring harness bracket too 1/4". Install kit **bracket, L-shaped** on wiring harness bracket with kit **bolt** (1/4" x 1"), two kit **washers** (1/4" SAE), and a kit **nut** (1/4" nylock).

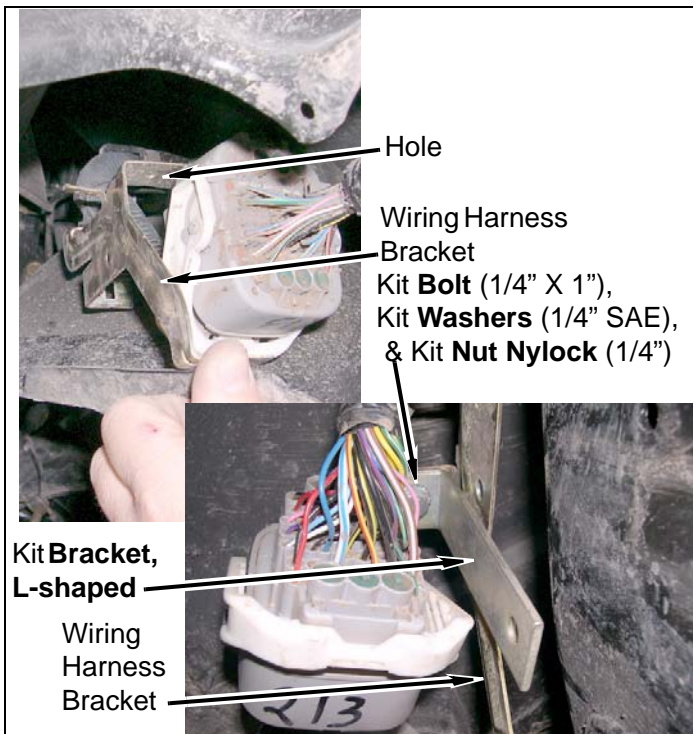

5. Fuel lines at the fire wall

- a. Install kit **bracket, S-shaped** on the engine side of the fuel / brake line bracket with a kit **washer** (1/4" SAE) and kit **nut** (1/4" nylock) as shown.

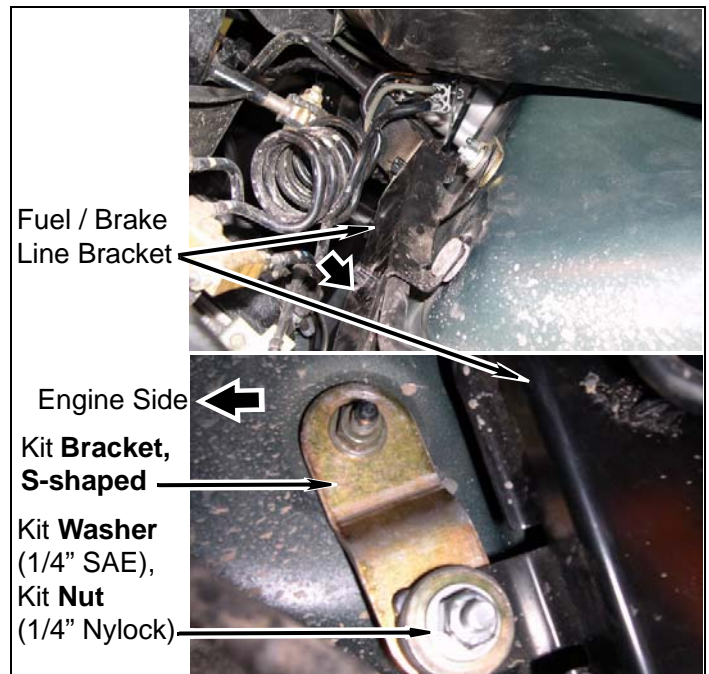

**NOTE**

It maybe necessary to slightly bend tab on the back side of wiring harness bracket to fit over the top of the frame.

- b. Install kit **bracket, straight** on the wheel well side of the fuel / brake line bracket with a kit **washer** (1/4" SAE) and kit **nut** (1/4" nylock) as shown. Install two kit **brackets** and fuel / brake line bracket on firewall with two nuts.

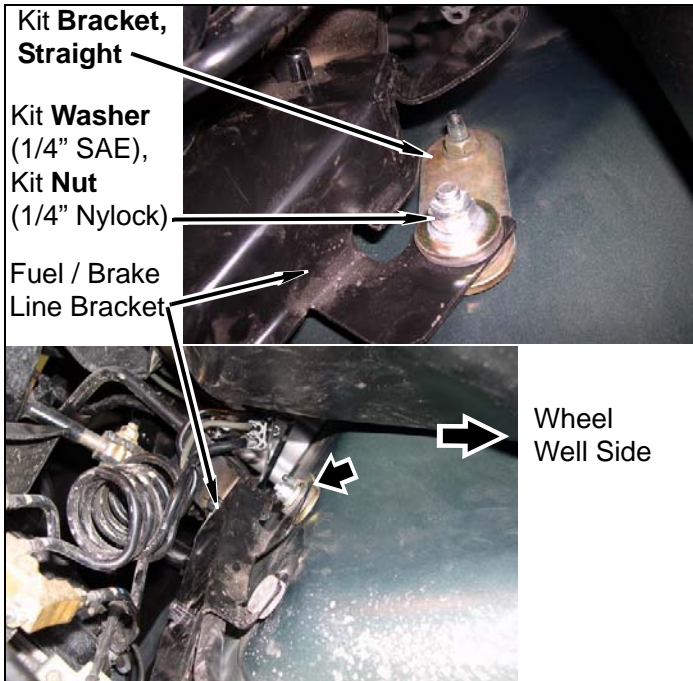

- b. Install steering shaft on kit **steering extension**, ensuring marks on steering shaft, kit **steering extension** and gear box are aligned.
- c. Apply a few drops of Loctite® to factory bolt and kit **bolt** (3/8" x 1 1/4" Allen head).

- d. Install and tighten bolts to 33 lb.-ft.

2. Inner fender well drivers side

- a. Install two power steering cooler line brackets on a kit **bracket C-shaped** and a kit **bracket J-shaped** with two kit **bolts** (1/4" x 1"), four kit **washers** (1/4" SAE), and two kit **nuts nylock** (1/4").
- b. Install kit **bracket, C-shaped** and a kit **bracket, J-shaped** on frame with two bolts.

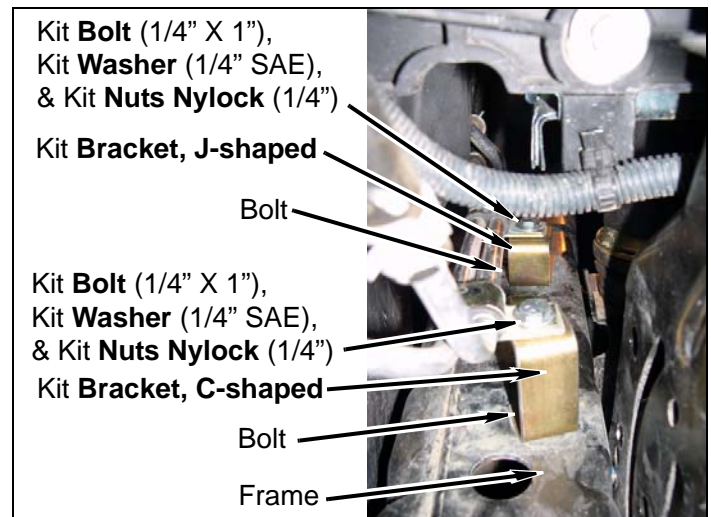

- c. Install wiring harness on frame with kit **zip-tie**.

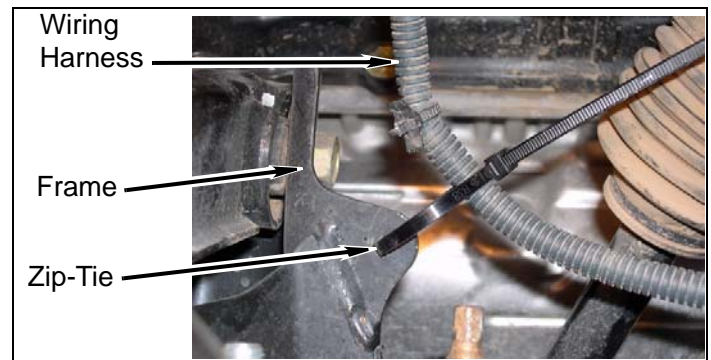

**Engine Compartment**

1. Steering shaft

**⚠ WARNING**  
 Verify the steering extension is securely installed as specified in the instructions. Failure to do so may cause steering malfunction, resulting in property damage or serious personal injury.

- a. Install kit **extension, steering** on steering gear box with kit **bolt** (3/8" x 1 1/4" allen head). Do not tighten. Carefully extend the mark from the Rack & pinion along kit **extension, steering**.

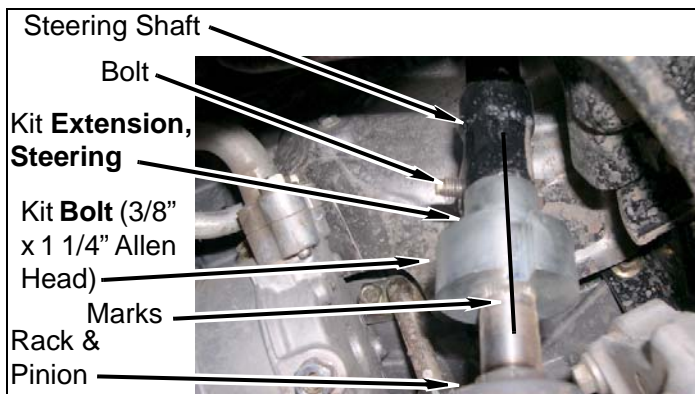



3. Fire wall

- a. Install AC line bracket on fire wall with nut.

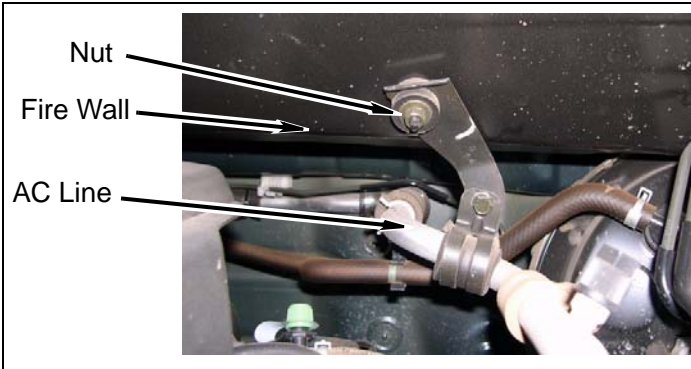

- b. Install kit **bracket** on AC selector valve with kit **nut** (1/4" nylock) and kit **washer** (1/4" SAE).  
c. Install kit **bracket** on fire wall with nut.

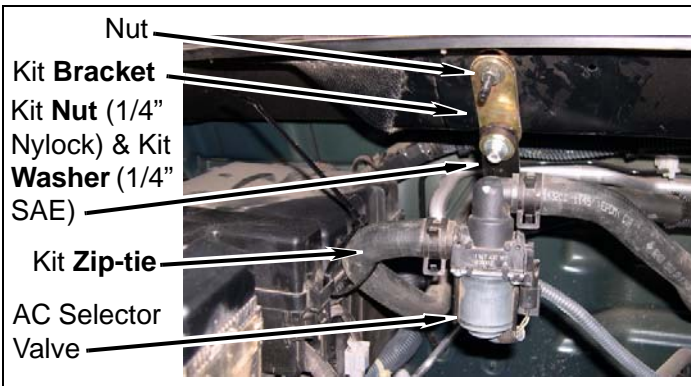

- d. Install kit **zip-tie** on hose of AC selector valve and electrical control box as shown.

4. Radiator

- a. Position support apparatus under radiator.

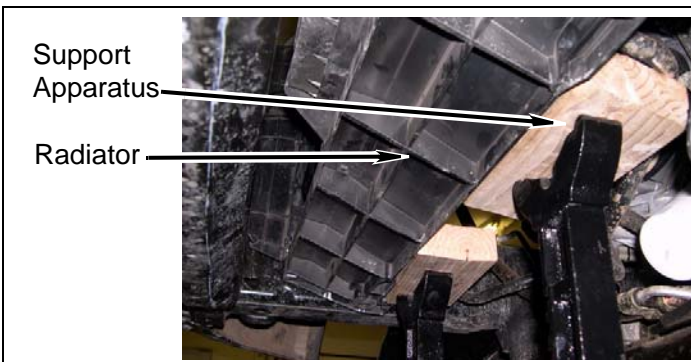

- b. Mark and cut lower radiator support and ribs as shown.

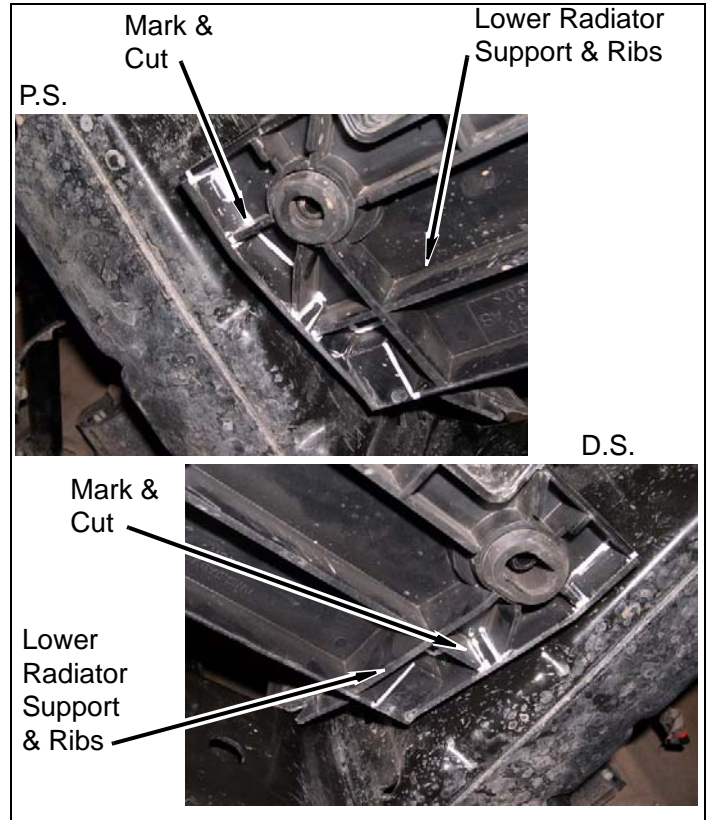

- c. Position and mark twelve holes from kit **brackets, upper radiator support** on lower radiator support. Drill 1/4" holes where marked.

**CAUTION**

In the step below ensure that you do not over tighten the bolts and nuts. On some of the bolts tighten only enough to ensure the bolt threads engage the nylock portion of the nuts.

- d. Install kit **brackets, upper radiator support** and kit **brackets, lower radiator support** on lower radiator support with twelve kit **bolts** (1/4" x 1-1/2") and twelve kit **nuts** (1/4" nylock).

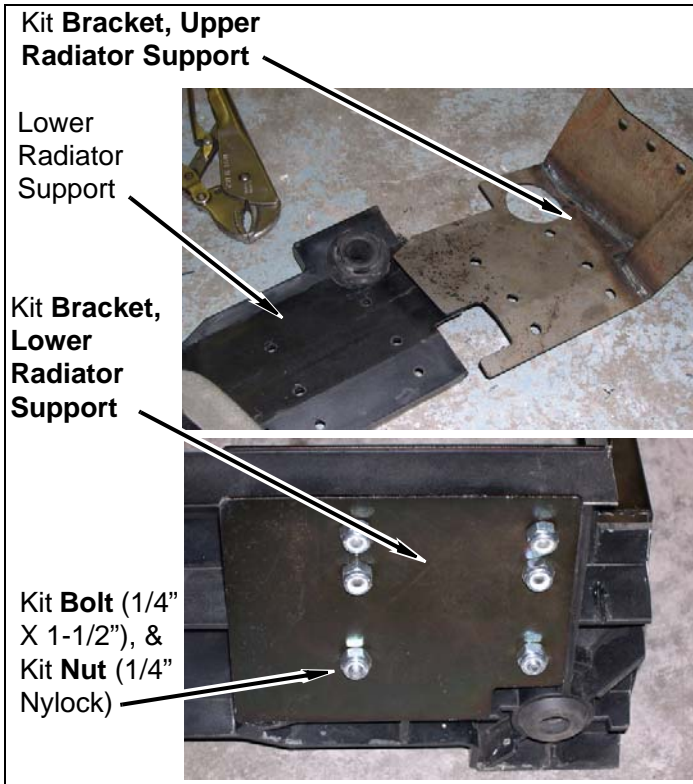

- e. Position and mark holes from kit **bracket, upper backing plate** on side support as shown. Drill 1/4" holes where marked.



- f. Install lower radiator support assembly and kit **bracket, upper backing Plate** on side supports with six kit **bolts** (1/4" x 1"), twelve kit **washers** (1/4" SAE), and six kit **nuts** (1/4" nylock).

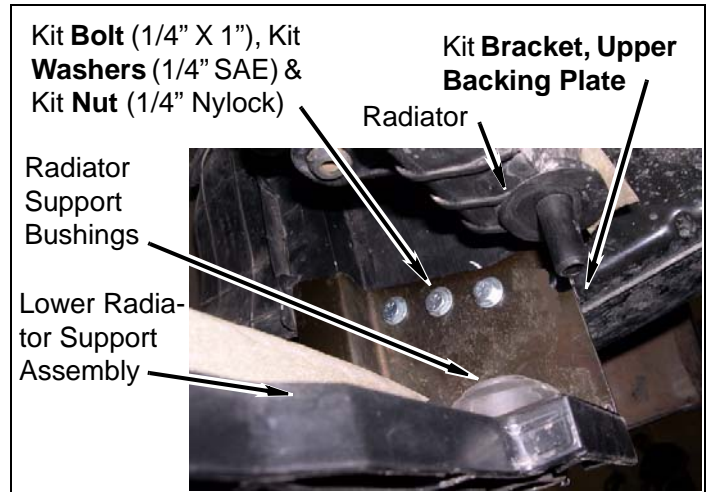

- g. Remove bolt and electric fan from core support.

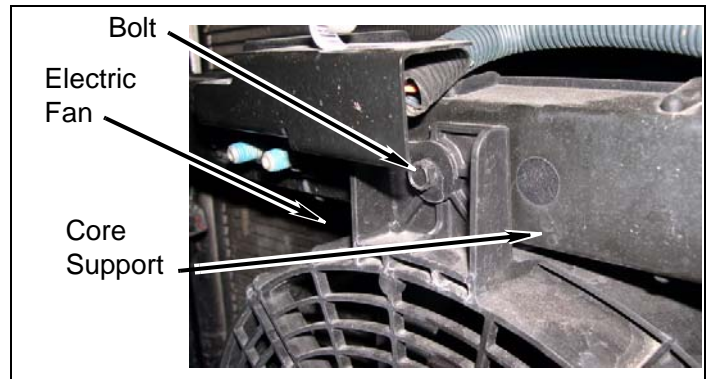

- h. Position electric fan on lower radiator support with two tabs.

- i. Install kit **bracket, S-shaped** on electric fan with kit **nut** (1/4" nylock) and kit **washer** (1/4" SAE).

- j. Install kit **bracket, S-shaped** (long) on core support with bolt.

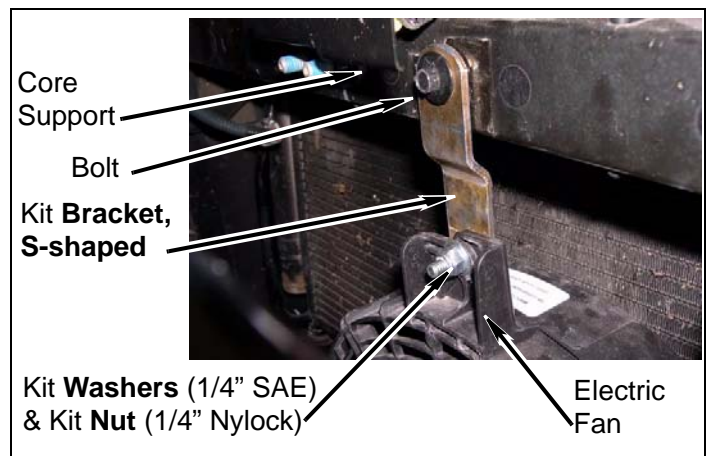



- k. Remove two silver clip nuts from radiator and install two kit **clip nuts** on radiator.

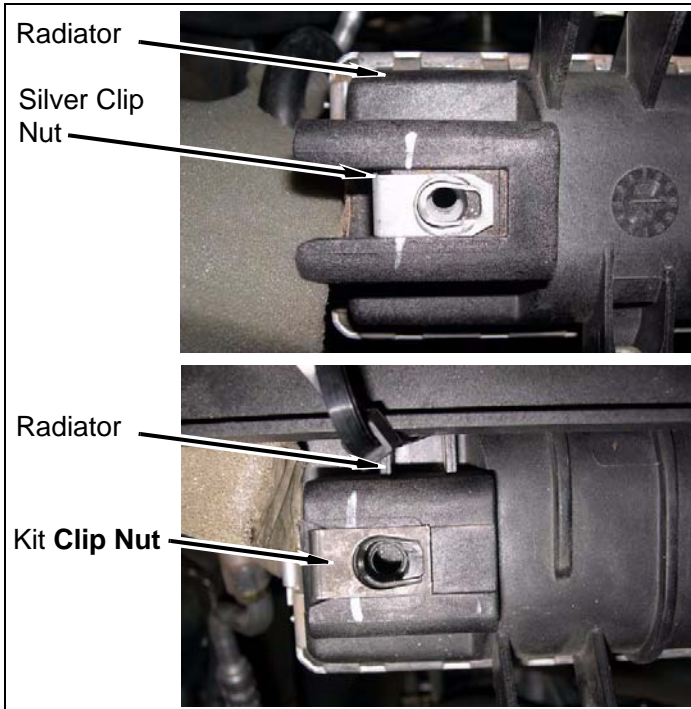

- l. Install two silver clip nuts on two kit **bracket spacers** as shown.

- m. Install two kit **bracket spacers** on radiator with two kit **bolts** (5/16" X 1") and two kit **washers** (5/16" USS).

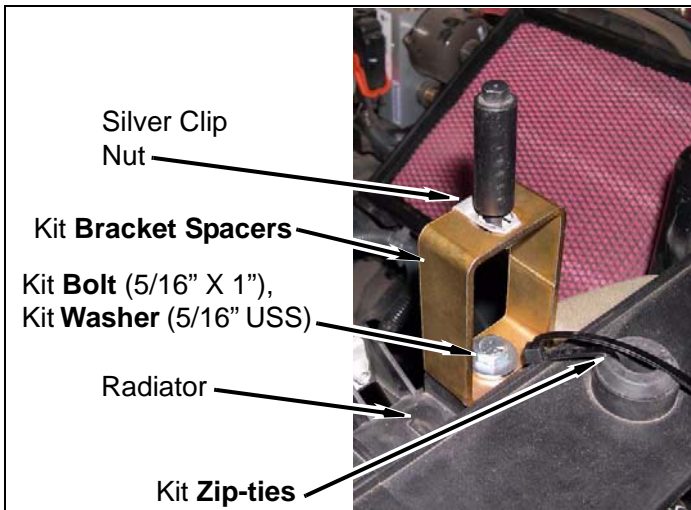

- n. Remove two kit **zip-ties** from core support and radiator.

- o. Remove the support apparatus from under radiator and position radiator on lower radiator support assembly. Ensure radiator lower studs are positioned in the radiator support bushings.

- p. Install radiator and two kit **bracket spacers** on core support with two shoulder bolts.



### 5. Radiator fan shroud

- a. Remove four nuts from fan pulley. Install fan clutch assembly on fan pulley with four nuts.

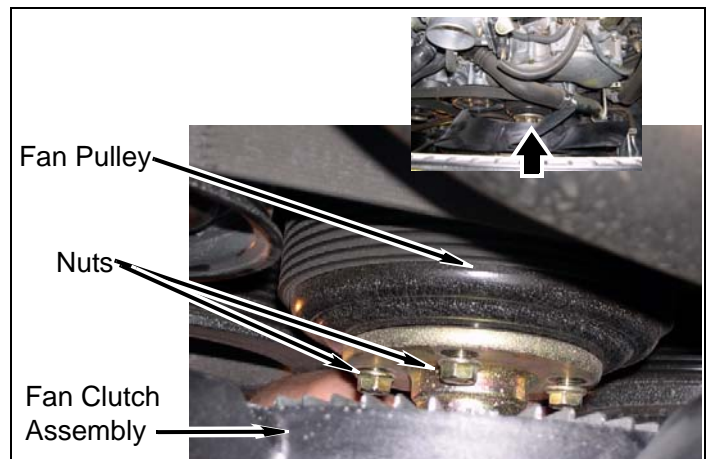

- b. Install fan shroud on radiator with two bolts and two lower clips.

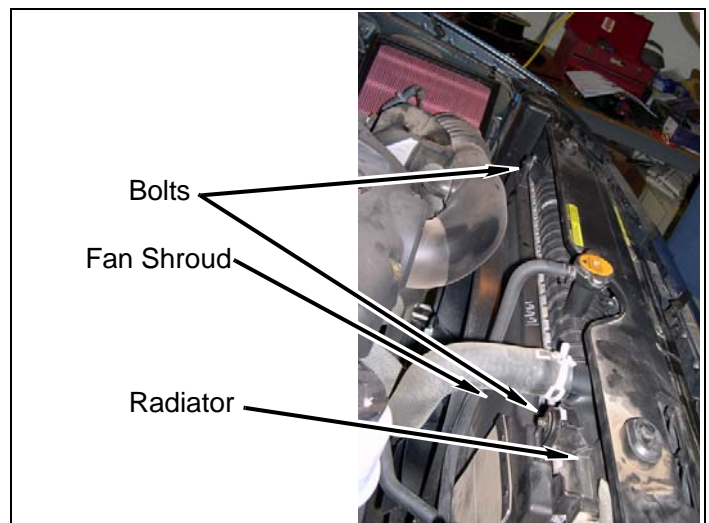

- c. Install upper radiator hose on radiator with hose clamp.

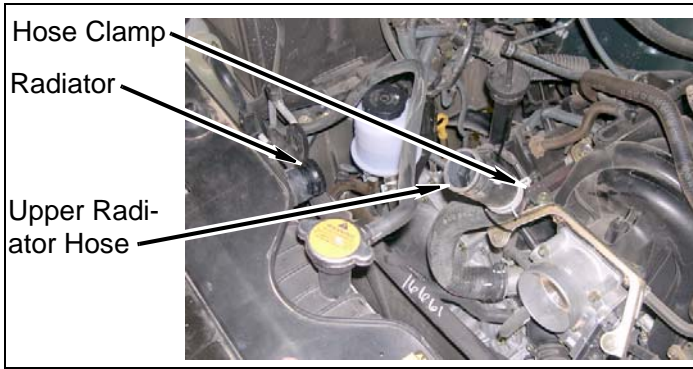

- d. Install three hoses on two fan shroud clips.

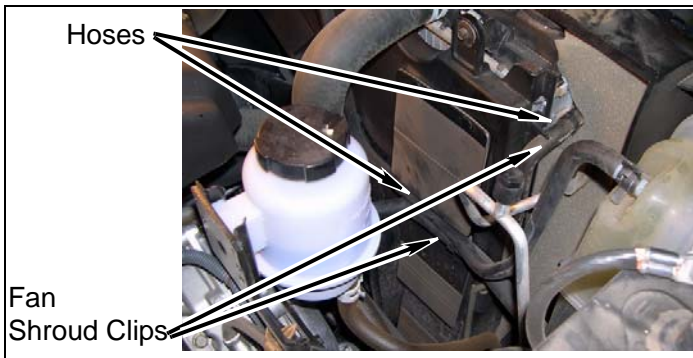

6. Inner fender well passenger side

- a. Install a lower clip on wiring harness.
- b. Install AC line on clip on inner fender.

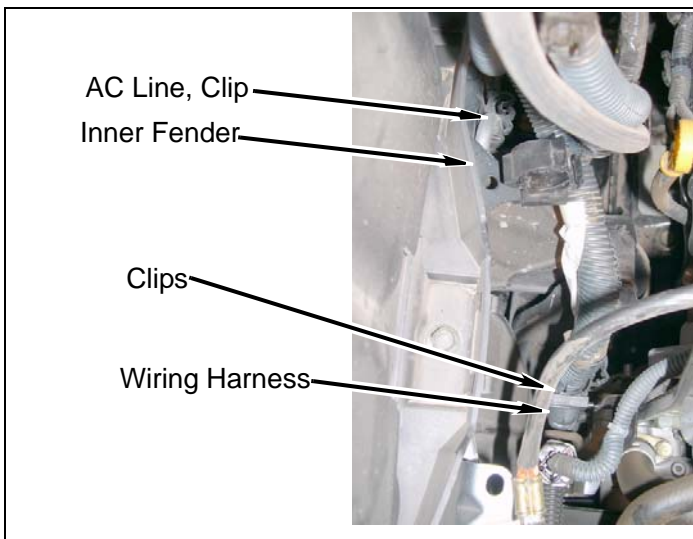

- c. Install transmission cooler line brackets on frame with two bolts.

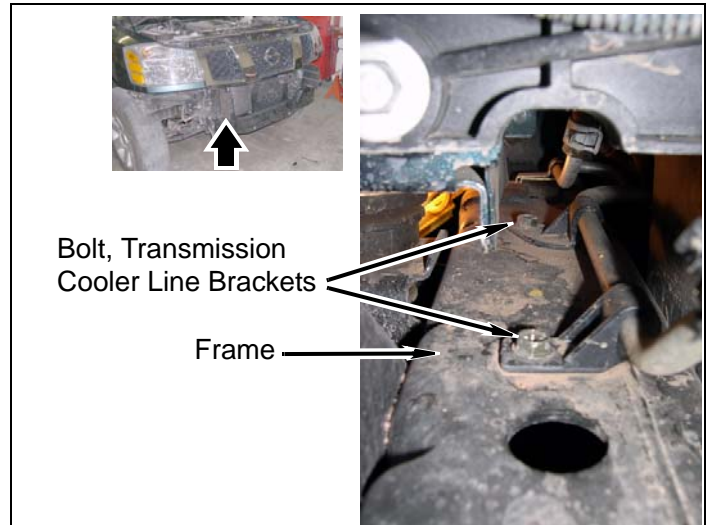

7. Air handling system

- a. Install air intake hose on engine with hose clamp.

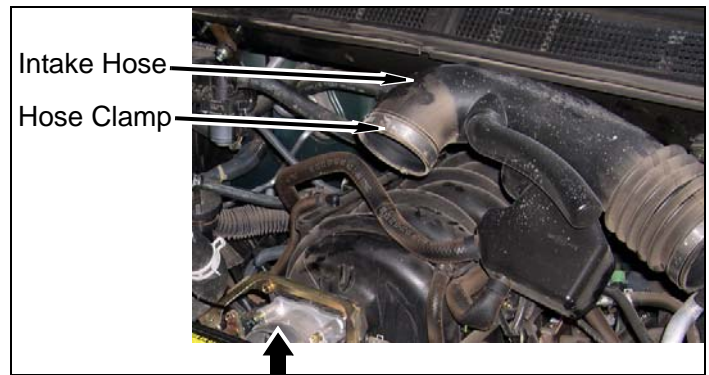

- b. Install two clips, hose clamp, axle vent hose, and axle vent hose clip on air cleaner base.

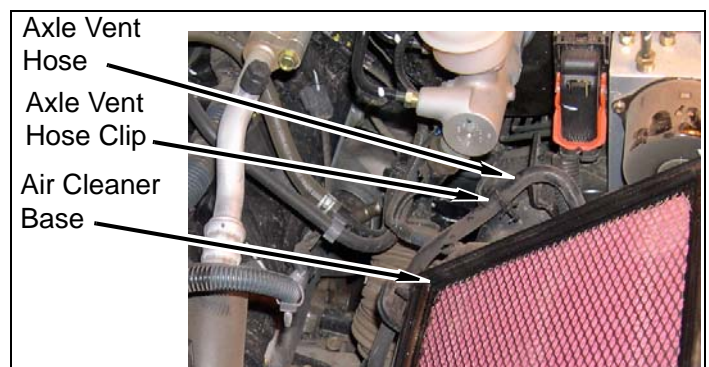



c. Install air cleaner cover on vehicle.

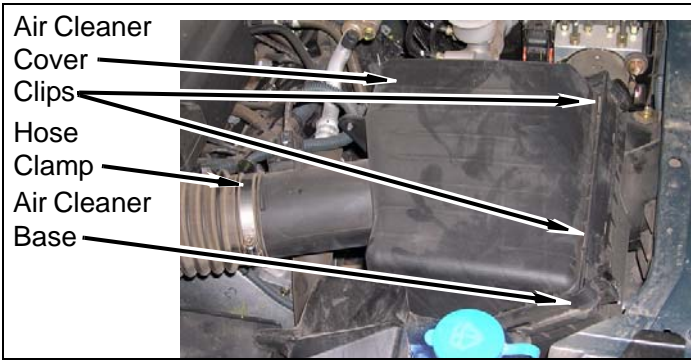

d. Install push clip and wire harness on air cleaner cover.

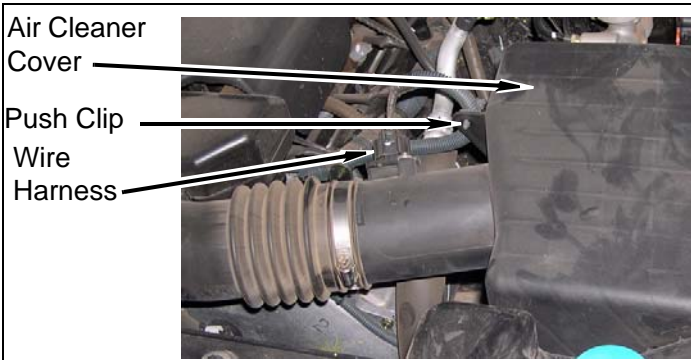

e. Position intake cover on engine mark and trim where interference occurs.

f. Install intake cover on engine with two bolts and two locator nipples.

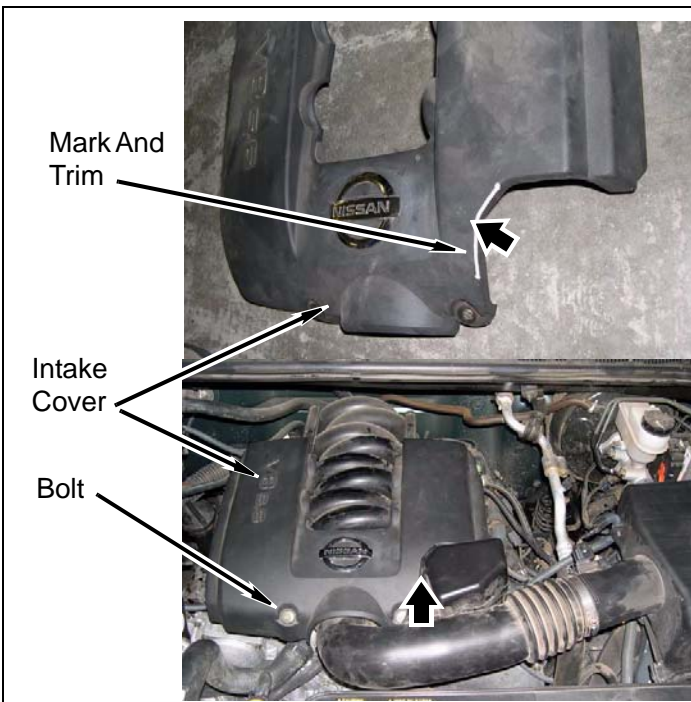

## Front bumper

1. Lower radiator

### ⚠ NOTE

Check drain plug.

a. Fill cooling system according to manufacturers specifications.

b. Install lower fan shroud on fan shroud and vehicle.



c. Install hose clip, metal transmission cooler hose, and transmission cooler hose on fan shroud and lower fan shroud.



2. Install skid plate on frame with four bolts.

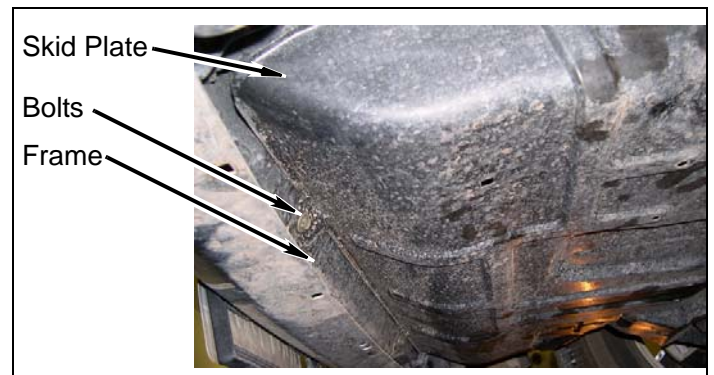

### 3. SE & LE models: Front bumper brackets

- a. Remove four bolts and two front bumper brackets from frame.

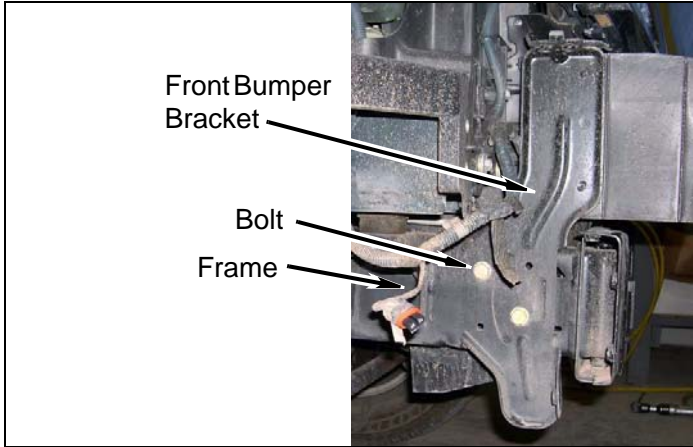

- b. Measure and mark 3" down on front bumper brackets. Drill 1/2" holes where marked.
- c. Cut and flatten front bumper bracket as shown.

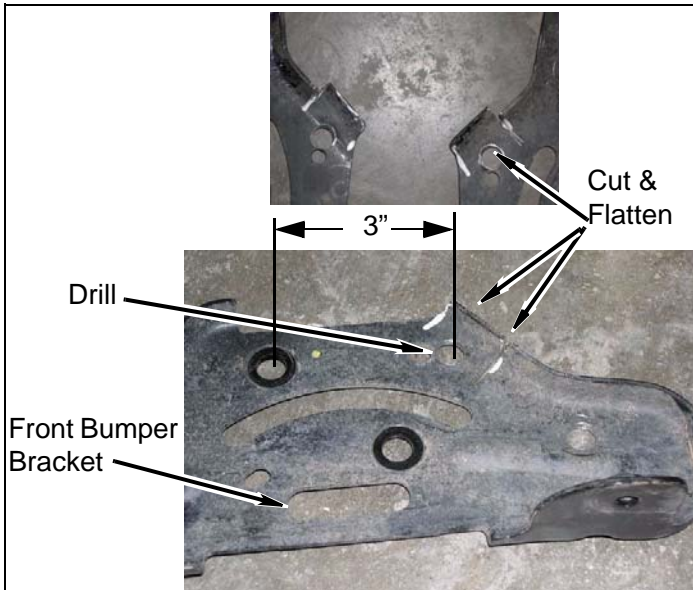

- d. Install two modified front bumper brackets on frame with four bolts.

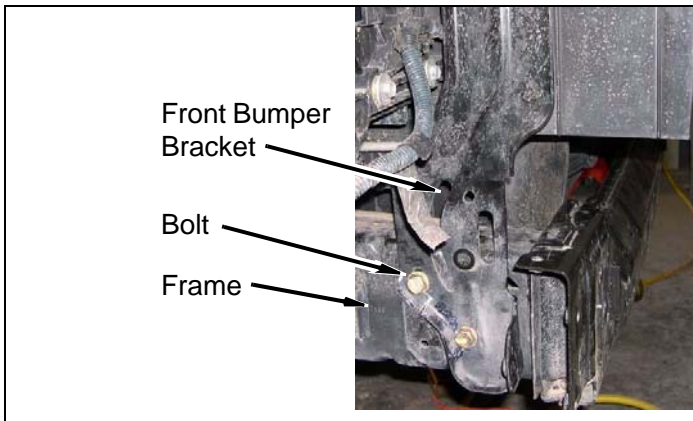

### 4. SE & LE models: Front bumper

- a. Remove four bolts, nuts, and two brackets from front bumper.

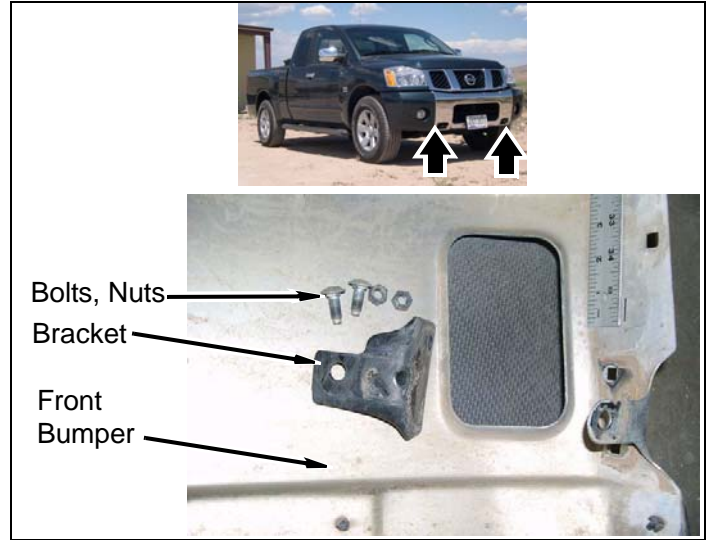

- b. Position front bumper on front bumper brackets and visually inspect the frame cross member where interference occurs along the bottom edge of the front bumper.

#### NOTE

When cutting the front bumper Performance Accessories recommends several small cuts and multiple test fittings on the front bumper brackets to achieve the desired fit.

- c. Remove front bumper and mark a line following the bottom edge of front bumper at a distance of 1-3/4 inches from the edge as shown.

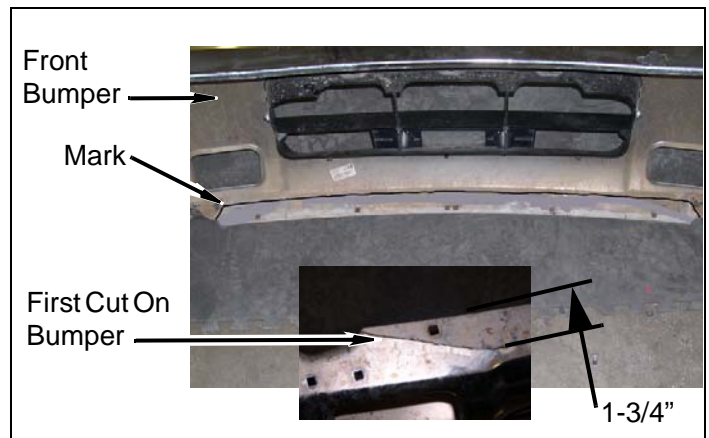

- d. Cut front bumper where marked as shown.



- e. Mark and cut frame crush zone driver and passenger side as shown.

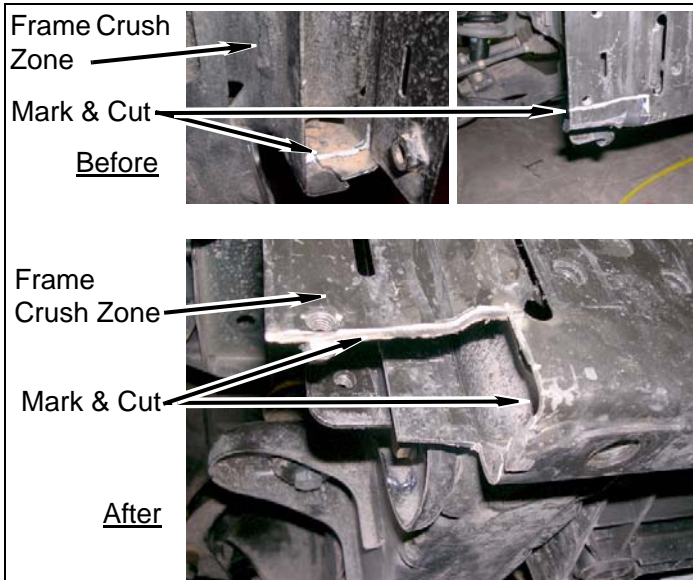

- f. Position front bumper on frame crush zone and check for interference. Trim as little as necessary.

- g. Install two brackets on front bumper with four bolts and nuts.

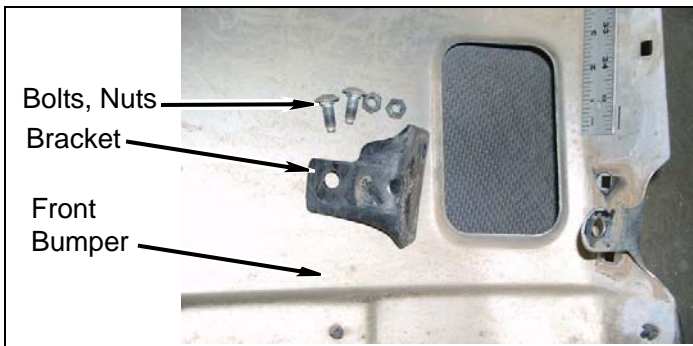

- h. Install kit **edge trim** on the cut edge of the front bumper.

- i. Install front bumper on front bumper brackets and vehicle with four top bolts. Do not tighten.

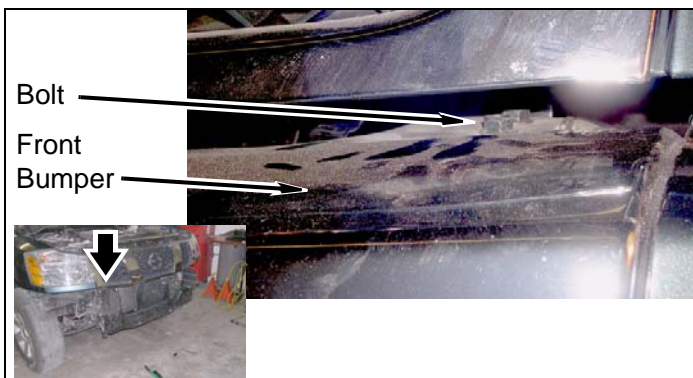

- j. Install front bumper and two kit **spacers** on front bumper brackets with two kit **bolts** (M8-1.25 X 40mm). Do not tighten.

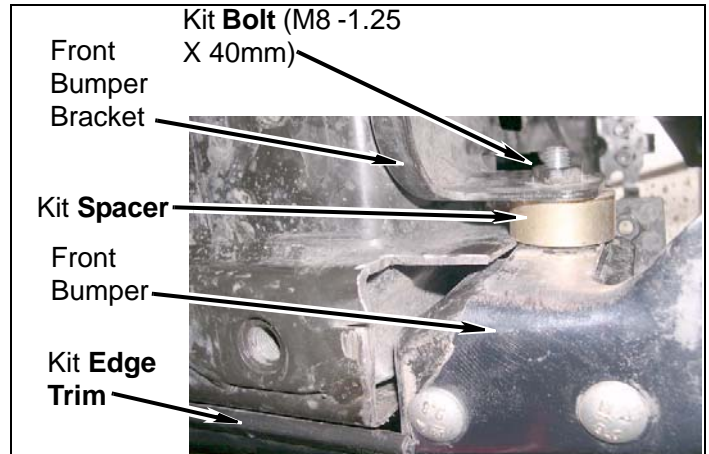

- k. Install four nuts and two side impact braces on front bumper.

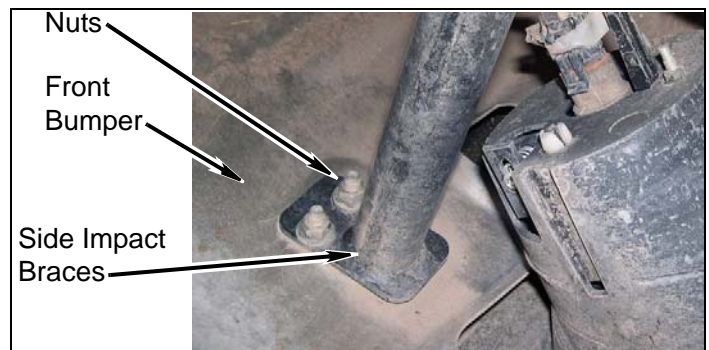

- l. Install two side impact braces on two kit **brackets, side impact** with four kit **bolts** (3/8" x 1"), eight **kit washers** (3/8" USS), and four **kit nuts** (3/8" nylock).

- m. Install two kit **brackets, side impact** on frame with four bolts.

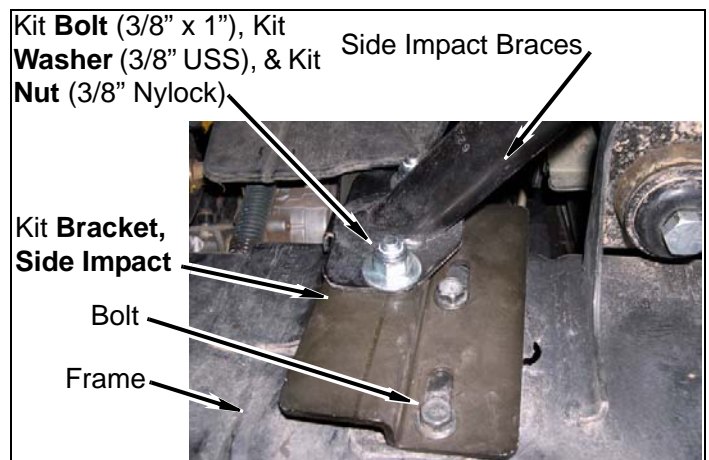

- n. Remove eight grill turn clips from core support. Install eight grill turn clips on grill.

- o. Install grill on core support and vehicle with eight grill turn clips.

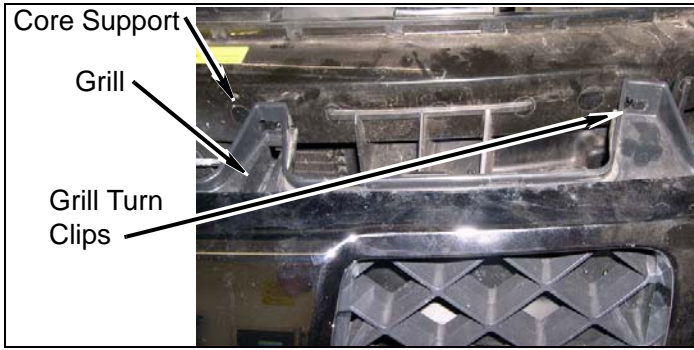

- p. If equipped, install two tow hooks on frame with four bolts.

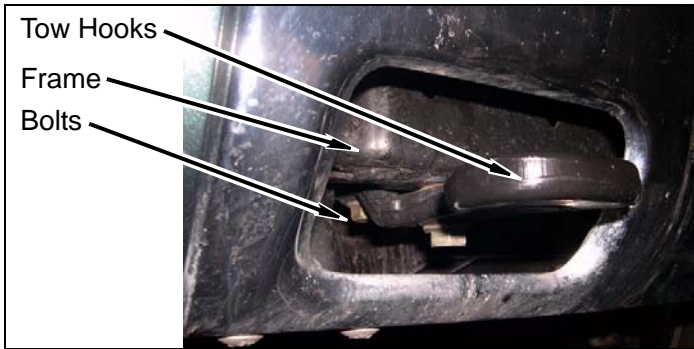

- q. If equipped, install two wiring harness connectors on running lights.

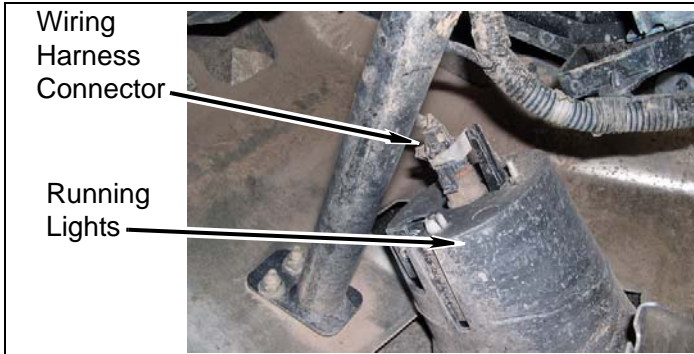

5. XE models: Front bumper

- a. Install two side impact braces on two kit **brackets, side impact** with four kit **bolts** (3/8" x 1"), eight **kit washers** (3/8" USS), and four **kit nuts** (3/8" nylock).

- b. Install two kit **brackets, side impact** on frame with four bolts.

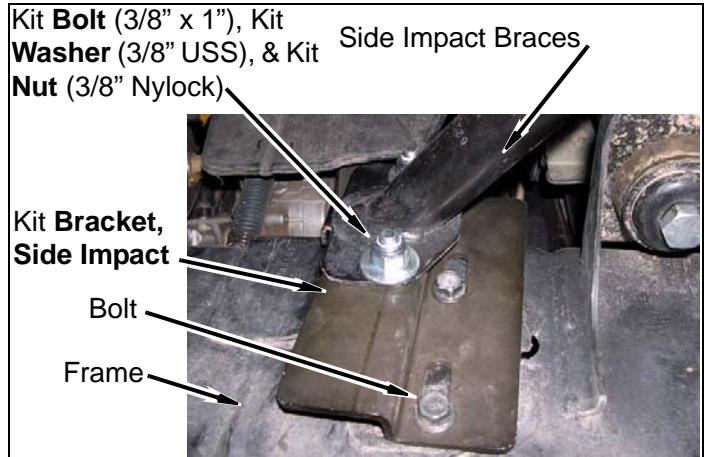

- c. Mark and cut two side bumper braces as shown.

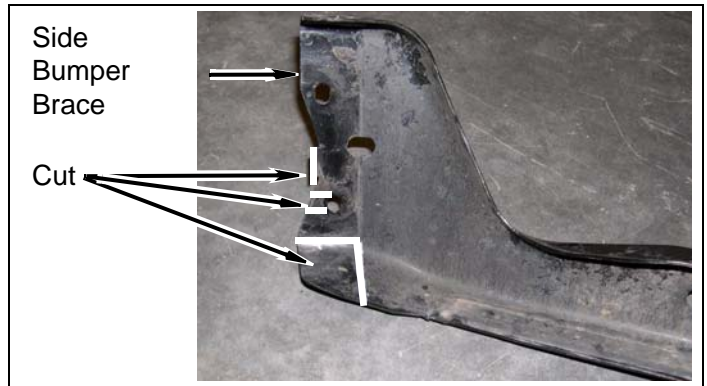

- d. Install two side bumper braces onto front bumper with two bolts, two kit **blocks, 2" diameter**, two kit **bolts** (8-1.25 x 90mm), and two kit **washers** (8mm).

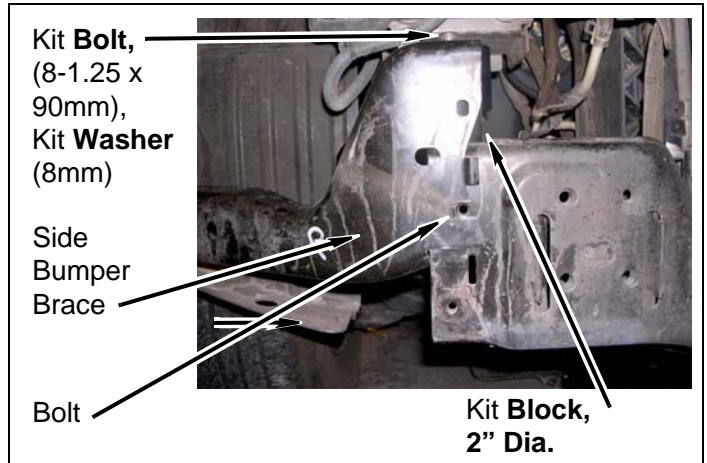



e. Install two side impact braces onto two side bumper braces with four nuts.

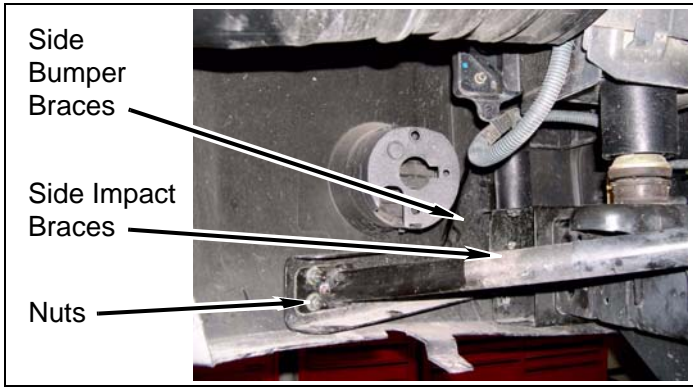

f. Install front bumper fascia onto support with six bolts.

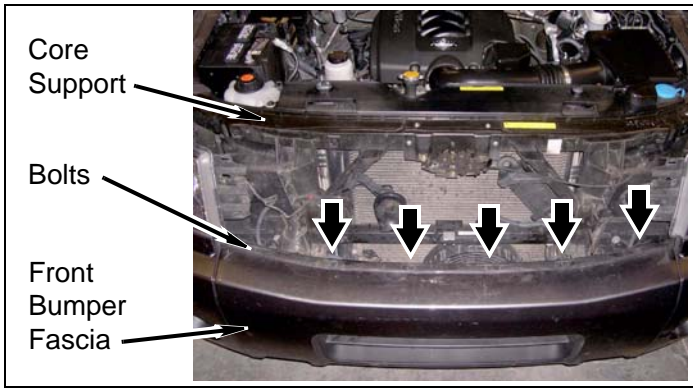

g. Install front bumper fascia onto support with three pop-up clips.

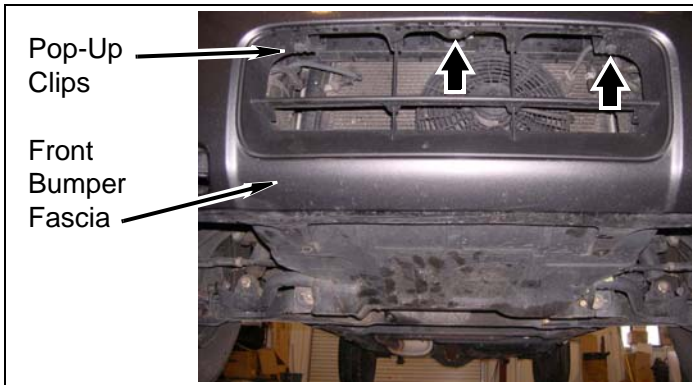

h. Install front bumper fascia onto front fenders with four bolts.

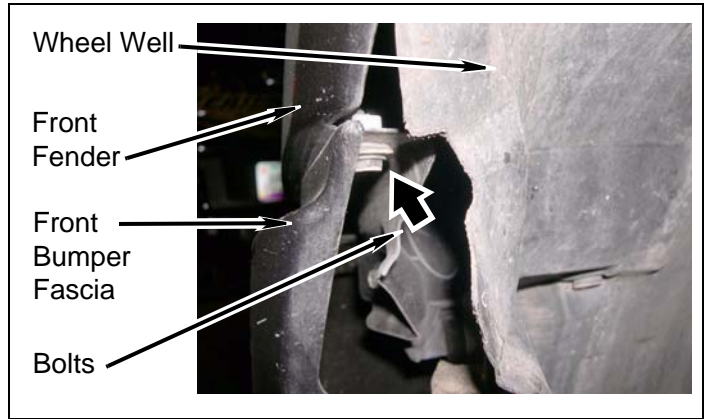

i. Install front bumper fascia onto driver and passenger wheel wells with six screws.

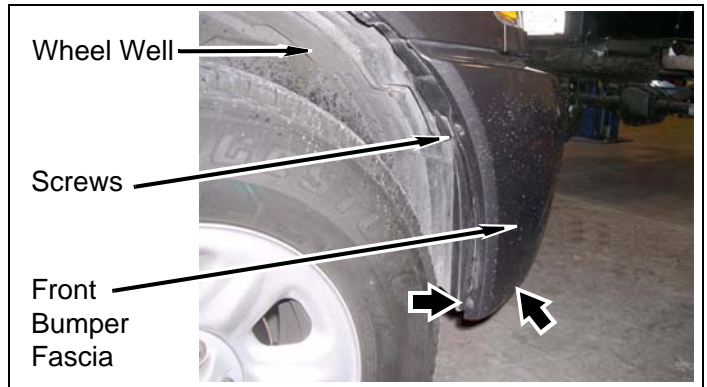

j. Remove eight grill turn clips from core support. Install eight grill turn clips on grill.

k. Install grill on core support and vehicle with eight grill turn clips.

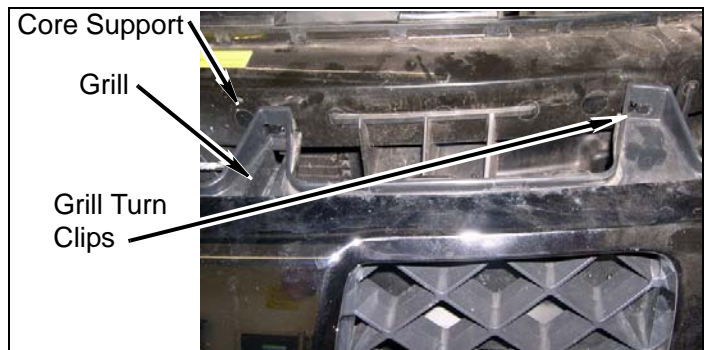

1. Install skid plate onto vehicle with four screws.



- m. Mark and drill two 1/4" holes into skid plate. Install front bumper fascia straps onto skid plate with two kit **push clips**.

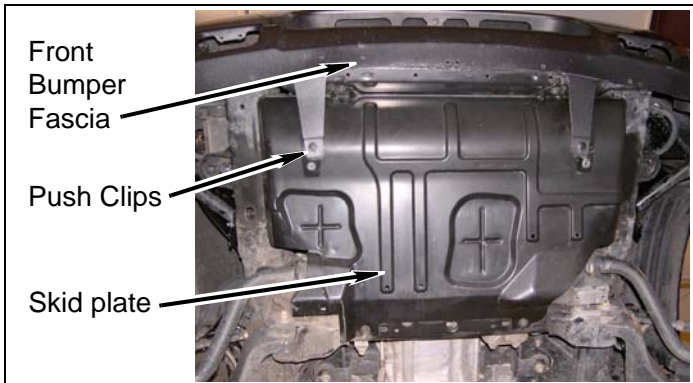

### Bed Spacers (Crush Blocks)

1. Remove four bed bushings from frame.

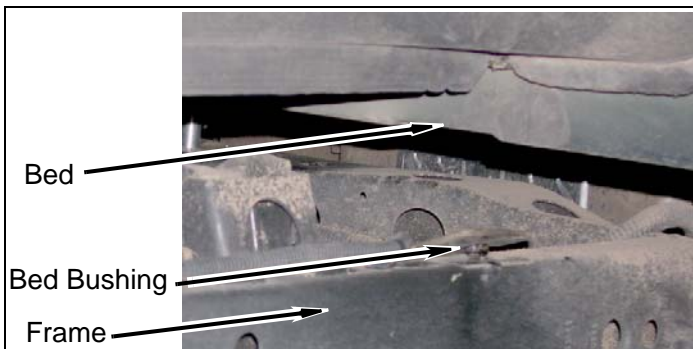

2. Install four bed bushings on four kit **bed spacers** (crush blocks). Position four kit **bed spacers** (crush blocks) on frame rail as shown.

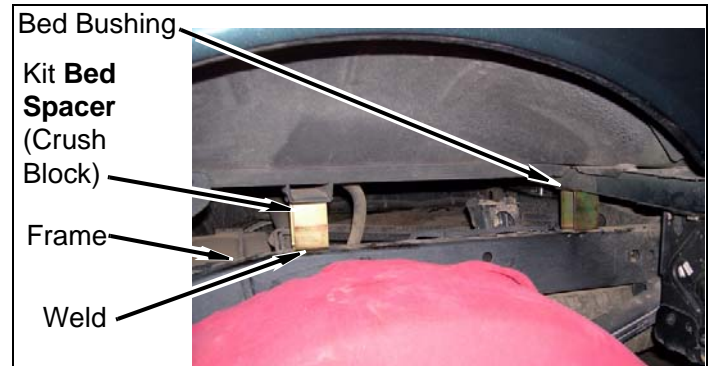

3. Tack-weld four kit **bed spacers** (crush blocks) to frame.

## After Completing Installation

### Inside Cab

1. Airbag fuse
  - a. Install airbag fuse.
  - b. Install fuse cover.

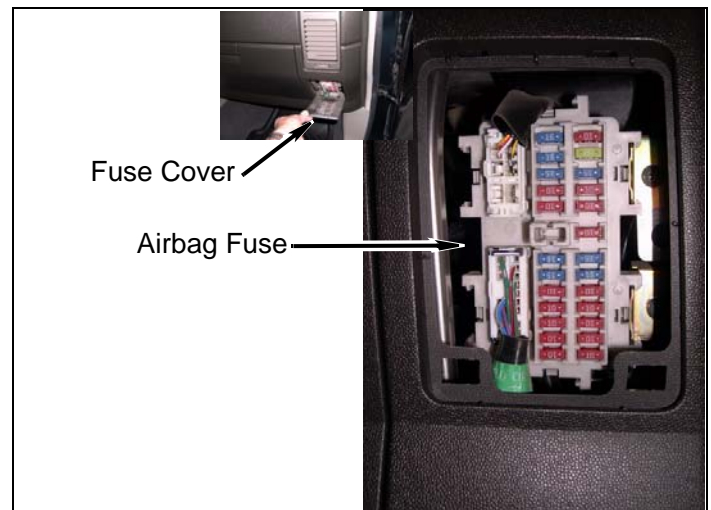

- c. Remove strap from steering wheel.

### Engine Compartment

1. Battery cables



- a. Connect both battery cables. Connect positive cable first, then negative cable.

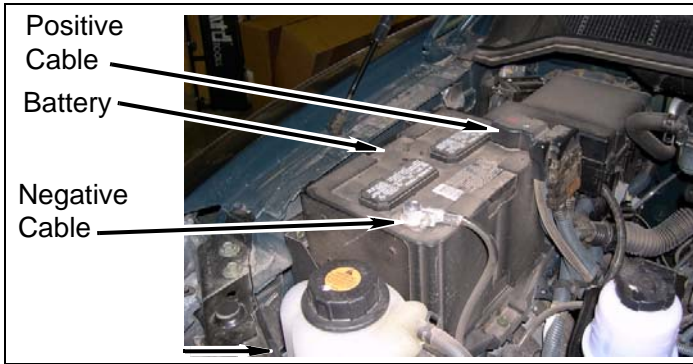

## Miscellaneous

1. Apply kit **label** (warning) to dashboard in plain sight of all vehicle occupants.
2. Adjust headlights.
3. Check all fasteners to ensure they are tight.
4. Ensure all wires, hoses, cables, etc. are properly connected and there is ample slack.

### ⚠WARNING

If the engine cooling system is hot, the coolant will be **HOT** and **UNDER PRESSURE**. To prevent serious personal injury, wait until the cooling system is completely cool before removing the cap from the radiator.

5. Start engine and top off cooling system. Purge air from cooling system according to manufacturer's instructions. Install radiator cap.

## Dynamic Vehicle Check

1. Test-drive vehicle. Check steering in both directions to ensure that there is no bind. Check operation of clutch, brake system, and parking brake. Check operation of transmission and transfer case. Ensure there is full engagement in all gears and 4WD ranges. Check battery connections and electrical component operations..

### ⚠WARNING

Retorque all fasteners after 500 miles and after off road use. All body lift components should be visually inspected and fasteners retorqued during routine vehicle servicing.

### ⚠CAUTION

Performance Accessories does not recommend any particular wheel and tire combinations for use with its body lifts and cannot assume responsibility for the customer's choice of wheels and tires. Refer to your owner's manual for recommended tire sizes and warnings related to the use of oversized tires. Larger wheel and tire combinations increase stress and wear on steering and suspension components, which leads to increased maintenance and higher risk for component failure. Larger wheel and tire combinations also alter speedometer calibration, braking effectiveness, center of gravity, and handling characteristics. Consult an experienced local off road shop to find what wheel and tire combinations work best with your vehicle.

### ⚠NOTE

All warranty information, instruction sheets, and other documents regarding the installation of this product must be retained by the vehicle owner. Information contained in the instructions and on the warranty card will be required for any warranty claims. The vehicle owner needs to understand the modifications made to the vehicle and how they affect vehicle handling and performance. Failure to provide the customer with this information can result in damage to the vehicle and severe personal injury.

### ⚠NOTE

Depending on the vehicle configuration (automatic or manual transmission, 2WD or 4WD, cab length, bed length, etc.), some parts may not be used.

# Accessories

The following accessories are available:

## Urethane Gap Guards

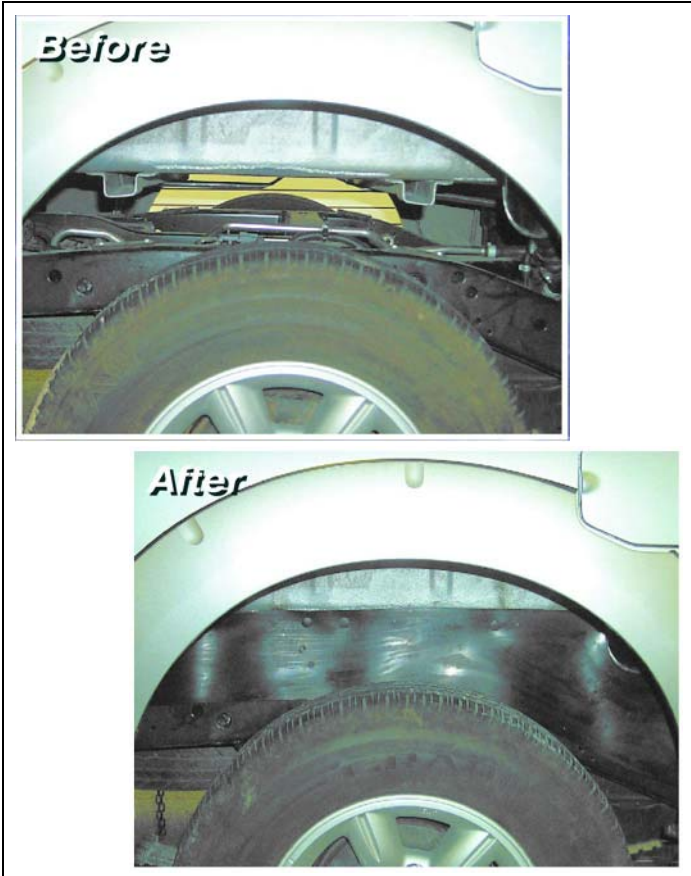



## Kit Parts List

QTY.	DESCRIPTION
12	<b>Block, Big</b>
6	<b>Block, Mini</b>
12	<b>Bolt, 1/4" x 1 1/2"</b>
10	<b>Bolt, 1/4" x 1"</b>
2	<b>Bolt, 8-1.25 x 90mm</b>
2	<b>Bolt, 10-1.25 x 100 mm</b>
6	<b>Bolt, 10-1.25 x 120 mm</b>
8	<b>Bolt, 12-1.25 x 180 mm</b>
8	<b>Bolt, 3/8 x 1"</b>
1	<b>Bolt, 3/8 X 1-1/4" Socket</b>
2	<b>Bolt, 5/16" x 1"</b>
10	<b>Bolt, 7/16"-14 x 1 1/2"</b>
2	<b>Bolt, 8-1.25 x 40 mm</b>
1	<b>Bracket, "C" Bend</b>
1	<b>Bracket, "J" Bend</b>
1	<b>Bracket, "L" Bend</b>
1	<b>Bracket, "S" Bend w/ Stud (Long)</b>
1	<b>Bracket, "S" Bend w/ Stud (Short)</b>
1	<b>Bracket, Side Impact Left</b>
1	<b>Bracket, Side Impact Right</b>
1	<b>Bracket, Hitch / Bumper Support</b>
1	<b>Bracket, Rad. Left Support Assy.</b>
1	<b>Bracket, Rad. Right Support Assy.</b>
2	<b>Bracket, Lower Radiator Support</b>
2	<b>Bracket, Upper Backing Plate</b>
1	<b>Bracket, Rear Bumper - Left</b>
1	<b>Bracket, Rear Bumper - Right</b>
2	<b>Bracket, w/ stud</b>
2	<b>Clip, push</b>
1	<b>Extension, steering</b>
1	<b>Guard, Edge (Black) 39"</b>
2	<b>Hose, 3/4" x 2"</b>
1	<b>Label, Logo</b>
25	<b>Nut, 1/4" Nylock</b>
8	<b>Nut, 3/8" Nylock</b>
10	<b>Nut, 7/16" Nylock</b>
2	<b>Nut, Clip (U-Nut)</b>
2	<b>Spacer, Spare Tire Winch</b>
4	<b>Spacer, Block 3" w/ Hole</b>
6	<b>Spacer, Block 3" w/ Holes</b>
2	<b>Spacer, Metal Tube</b>
4	<b>Tie, Zip</b>

QTY.	DESCRIPTION
2	<b>Warning, Rear Bumper Bracket</b>
20	<b>Washer, 1/4" SAE</b>
12	<b>Washer, 3/8" USS</b>
2	<b>Washer, 5/16" USS</b>
10	<b>Washer, 7/16" SAE</b>
18	<b>Washer, 7/16" USS</b>
8	<b>Washer, 8mm</b>

