



841 S. 71st Avenue • Phoenix, AZ 85043
(623) 907-0081
www.performanceaccessories.com

CHEVY/GMC 2500HD ONLY
BODY LIFT KIT
INSTALLATION INSTRUCTIONS
2003-2005 2" KIT # PA10092
2003-2005 3" KIT # PA10093

MANUAL TRANS. REQUIRES
KIT SE4701

⚠WARNING
This body lift kit should only be installed on vehicles in good working condition. Before installation, the vehicle should be thoroughly inspected for evidence of corrosion or deformation of the sheet metal around the factory body mounts. This body lift kit should not be installed on any vehicle that is suspected to have been in a collision or misused. Off road use of your vehicle with this body lift installed may increase the stress applied to the factory body mounts. We do not recommend that any vehicle with a body lift installed be involved in any extreme off road maneuvers such as jumping. Failure to observe this warning may result in serious personal injury and/or severe damage to your vehicle.

⚠WARNING
Many states now have laws restricting bumper heights and vehicle lifts. Local laws should be consulted to determine if the changes you intend to make to your vehicle comply with state laws.

⚠WARNING
The installation of larger wheel and tire combinations may reduce the effectiveness of the braking system.

⚠WARNING
We will not warranty any damage to the A/C system.

⚠WARNING
Always wear eye protection when operating power tools.

⚠WARNING
Ensure that your vehicle tires are properly blocked and secured before you begin installation of this lift kit.

⚠WARNING
To ensure the Supplemental Restraint System (SRS, or air bag) is not accidentally deployed during lift kit installation, always ground yourself and the vehicle. Do not use power or pneumatic tools. Exercise extreme caution while working near SRS sensors and wiring. Do not allow anyone near air bags during lift kit installation. Accidental deployment can result in serious personal injury or death.

⚠NOTE
Performance Automotive Group recommends using the Loctite® supplied on the threads of all fasteners unless noted in the instructions.

⚠WARNING
DO NOT combine suspension, body, or other lift devices. Use of vehicle with combined lifts may result in unsafe and/or unexpected handling characteristics.

⚠WARNING
Installation of a Performance Automotive Group body lift will change the center of gravity and the handling characteristics of the vehicle. Because of the higher center of gravity and larger tires, the vehicle will handle and react differently both on and off road. You must drive it safely! Extreme care must be taken to prevent vehicle rollover or loss of control, which could result in serious injury or death. Avoid sudden sharp turns or abrupt maneuvers and always make sure all vehicle occupants have their seat belts fastened.

⚠WARNING
Read and understand all instructions, warnings, cautions, and notes in this sheet and in your owners manual before you begin the installation of this body lift kit.

⚠CAUTION
Proper installation of a Performance Automotive Group body lift kit requires knowledge of the factory recommended procedures for disassembly and assembly of original equipment components. We recommend that the factory shop manual and any special tools necessary to your vehicle be on hand during the installation. Installation of this body lift kit without proper knowledge of the factory recommended procedures may affect the performance of these components and the safety of your vehicle. We strongly recommend that a certified mechanic familiar with the installation of similar components install this body lift kit.

A. Before you start.

⚠ NOTE

As you read through this procedure, note that each part referenced has the same callout number throughout. Also, the part number in the text matches the corresponding part number in the pictures. Kit parts are prefaced by the word *kit* in italics.

1. Carefully read all warnings and instructions completely before beginning.
2. Verify all parts have been received in this kit by checking the parts list at the end of this document.

⚠ NOTE

If parts are missing from kit, please be prepared to provide the following information:

1. **Name** of purchase location
2. **Bar Code** on side of box
3. **Date** above bar code
4. **Date** inside box cover
5. **Inspector #** from inside box cover

3. **Only install this kit on the vehicle for which it is specified.** If anytime during the installation you encounter something different from what is outlined in the instructions, call technical support at (928) 636-7080.
4. Special tools needed:
 - a. Welder (or access to a professional welding shop) (manual-shift 4WD only).
 - b. Die grinder or similar tool capable of cutting metal.
5. Park the vehicle on a clean, dry, flat, level surface and block the tires so the vehicle cannot roll in either direction.
6. Disconnect both battery cables. Disconnect the negative cable (1) first, then the positive cable (2) from the battery (3).
7. Remove cover (4) and the airbag fuse (5) from the fuse panel (6). Fuse locations may vary. Check fuse chart on back of cover (4).

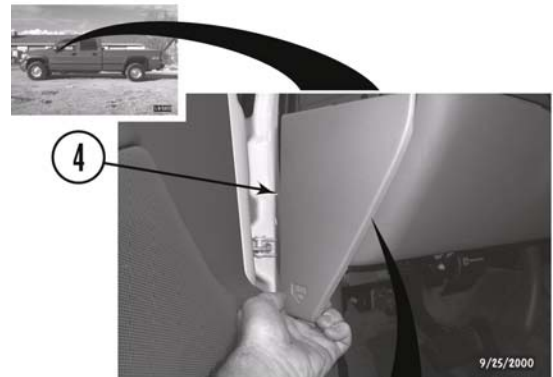
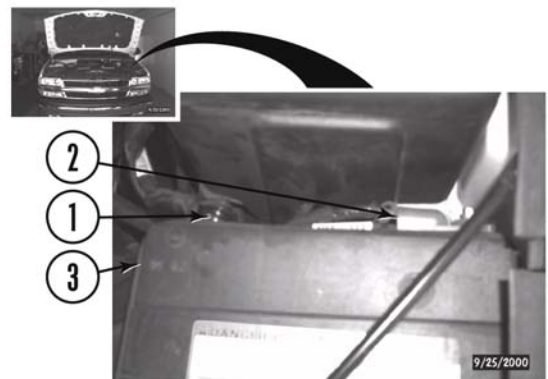

B. Get ready to install the kit.

1. Remove the grille.

- a. Remove seven panel clips (7) and cover (8) from core support (9).

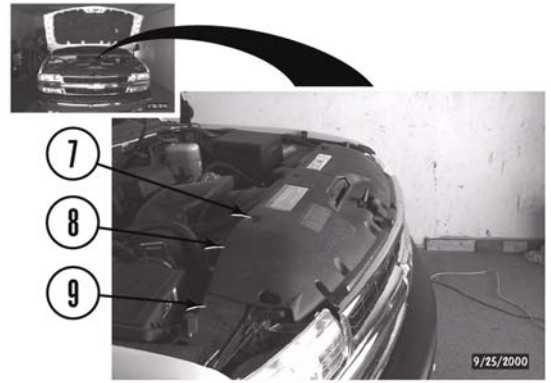

- b. Remove bolt with captive washer (10), loosen four phillips head/dzeus fasteners (11), remove two clips (12) and grille (13) from core support (9) and front fenders (14).

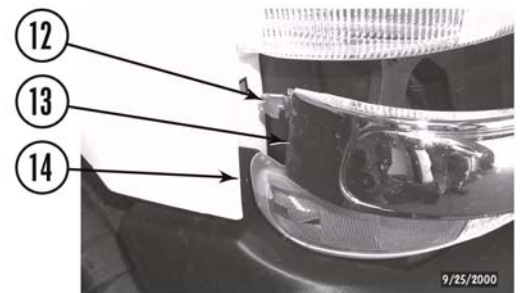
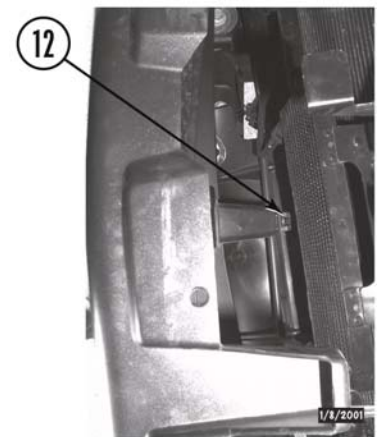

2. Remove the front bumper.

- a. Measure distance between the front bumper (15) and front fenders (14). Record measurement.

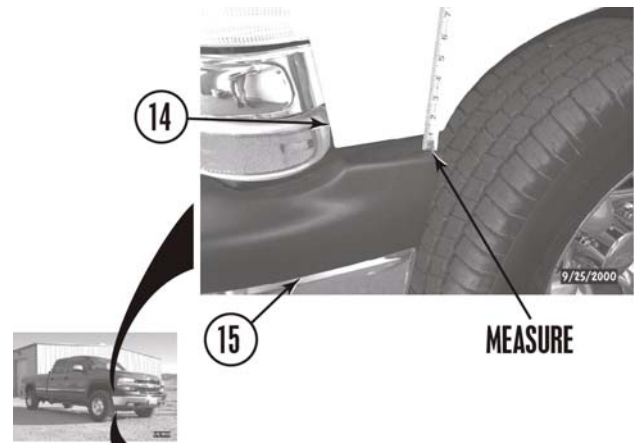

- b. If so equipped, remove two connectors (16) from fog lamps (17).
c. Remove six bolts (18) and two front side bumper brackets (19) from front bumper (15) and frame (20).

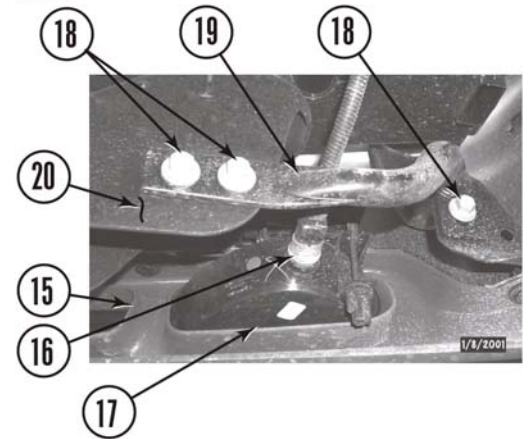

- d. Remove four bolts (21 and 22) and front bumper (15) from frame (20).

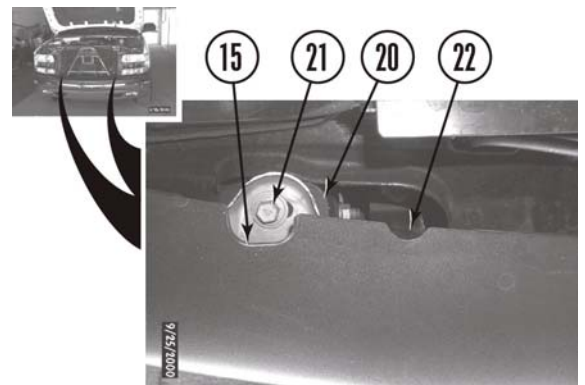

- e. Remove six bolts with captive washers (23) and tow hooks (24) from the frame (20).

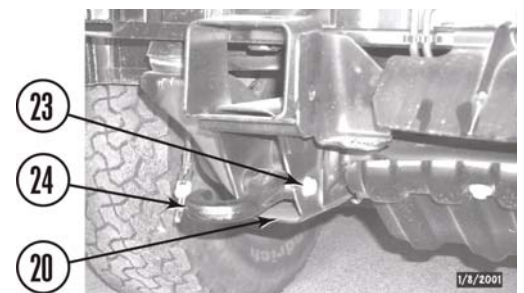

- f. Remove five bolts with captive washers (25) and plastic cover (26) from core support (9) and frame (20).

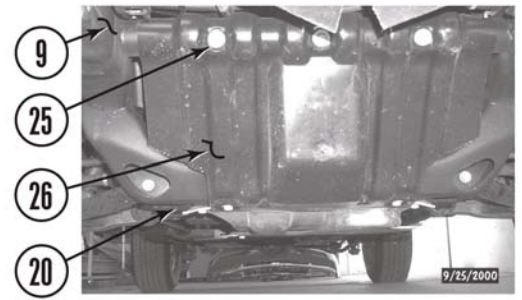

- g. Remove three pop-ups (27) and air flap (28) from core support (9).

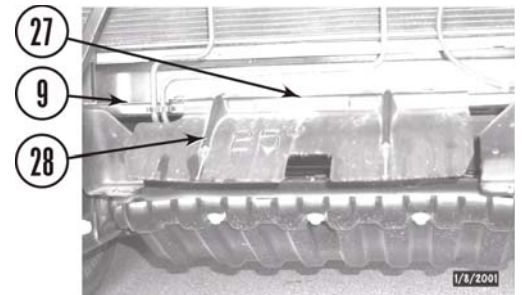

- h. If so equipped, remove two bolts (29), two panel clips (30), and transmission cooler (31) from core support (9) A-frame. Remove two lines (32 and 33) from clip (34). Remove clip from core support.

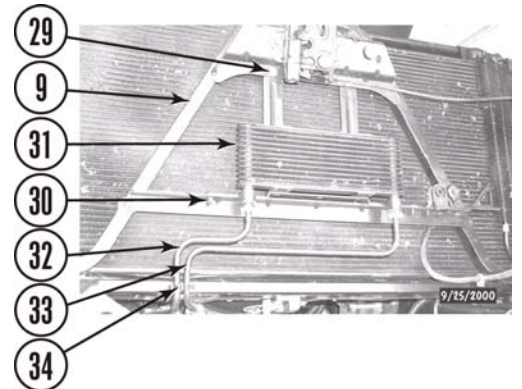

- i. Remove two nut clips (35) from transmission cooler (31) and install in holes on core support (9) A-frame.

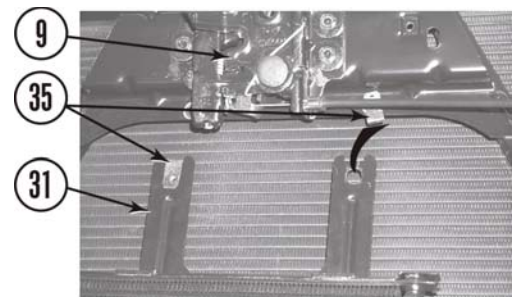

3. Under the hood.

- a. Remove hose (36) from two clamps (37 and 38).
- b. Remove hose (39) from clamp (40).
- c. Loosen two clamps (41 and 42) and remove air duct (43) from air filter housing (44) and throttle body (45).

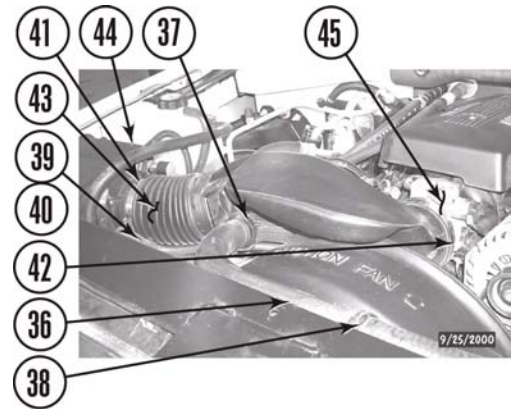

- d. Remove two bolts (46) securing upper half of fan shroud (48) to upper core support. Remove four pop-ups (47) securing upper half of fan shroud (48) to bottom half. Remove upper half of fan shroud (49) from engine compartment.

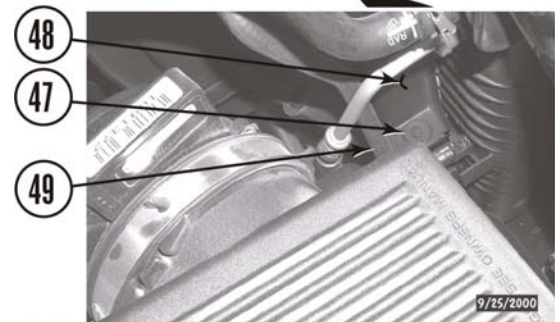
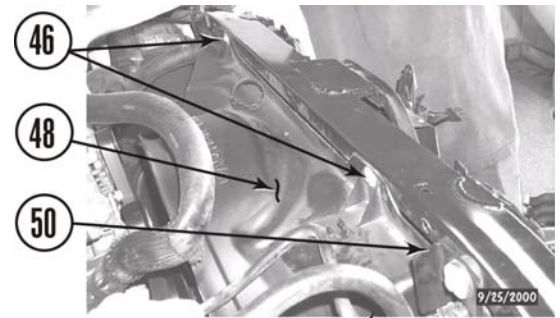

- e. Remove two lines (51 and 52) from clip (53). Remove clip from lower half of fan shroud.

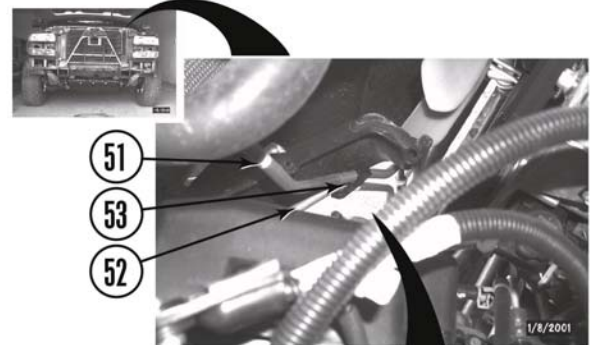

- f. Move lines (51 and 52) out of way and drop the lower half of fan shroud (49) below the core support (9).

- g. Rotate lower half of fan shroud (49) around fan blades and remove it from the engine compartment.

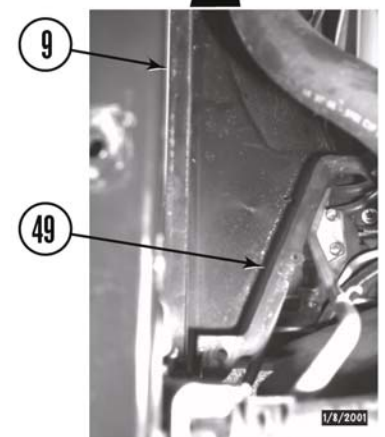

NOTE
Ensure steering shaft does not turn independently of the steering gearbox. This could cause the air bag system to malfunction, resulting in serious personal injury or damage to the equipment.

- h. Straighten steering wheel and strap the wheel so it will not turn.
- i. Remove bolt (54) and clip (55) and slide upper steering shaft (56) up to separate from lower shaft (57). Upper shaft may not separate from lower shaft until lift blocks are installed.

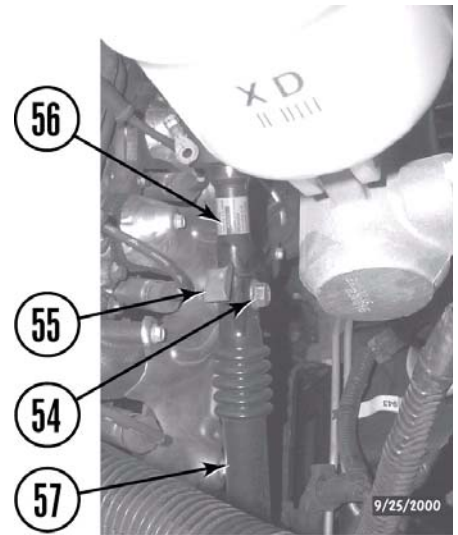

- j. Remove nut (58) and ground strap (59) from stud (60).

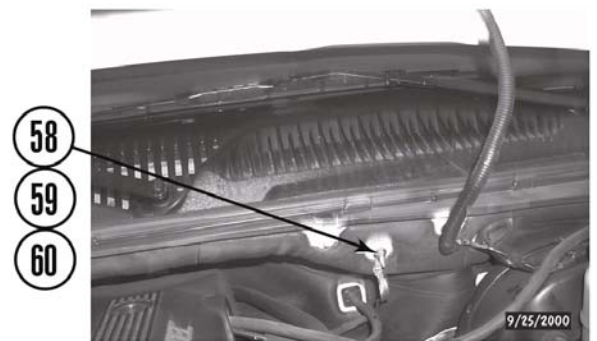

- k. Remove clip (61) from bracket (62).

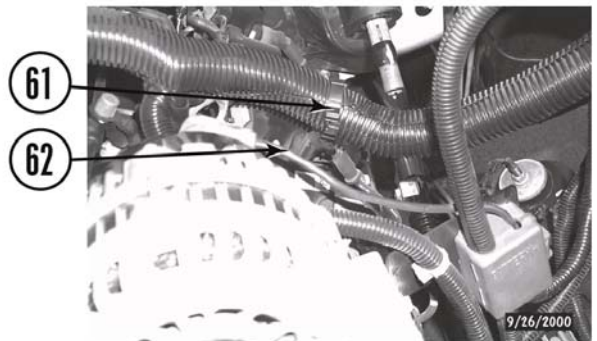

4. Along the frame rails.

- a. Remove clip (63) and harness (64) from frame (20) driver side.

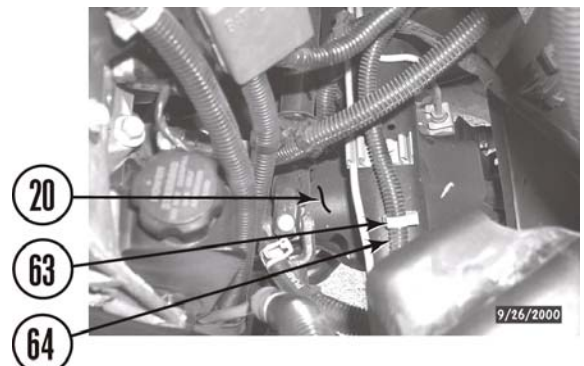

- b. Remove four clips (65, 66, 67 and 68) from frame (21) driver side and wheel well (69).

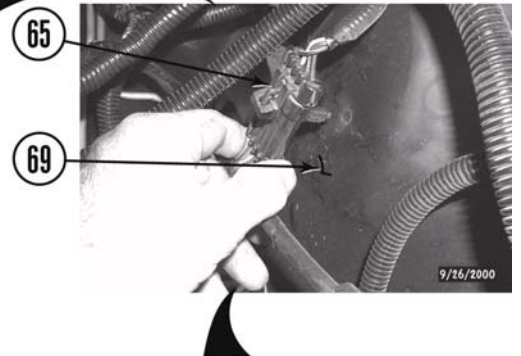

- c. Remove two brake lines (70) from pop-up clip (71).

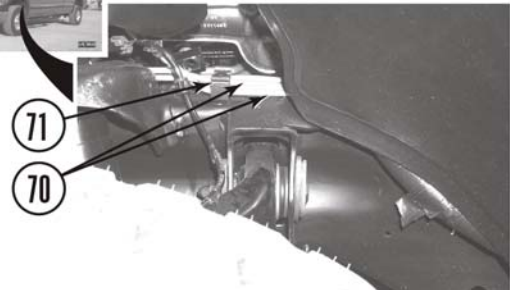

- d. Remove bolt (72) and two ground wires (73 and 74) from driver side frame mounting pad (75).
- e. Remove (you may have to cut) clip (76) and remove harness (77) from driver side frame mounting pad (75).
- f. Remove two clips (78 and 79) and harness (77) from frame (20) driver side.

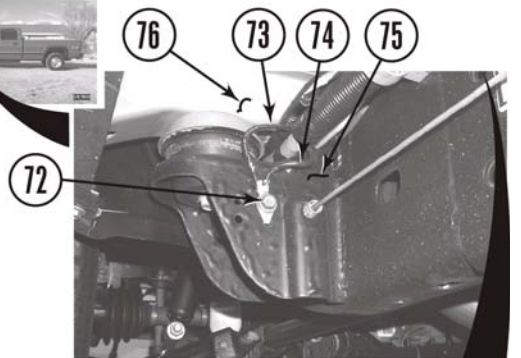

- g. Measure length of threads on parking brake cable (80) adjuster and remove nut (81) from adjuster and clevis (82).
- h. Pull parking brake cable (80) through two driver side frame mounting pads (75).

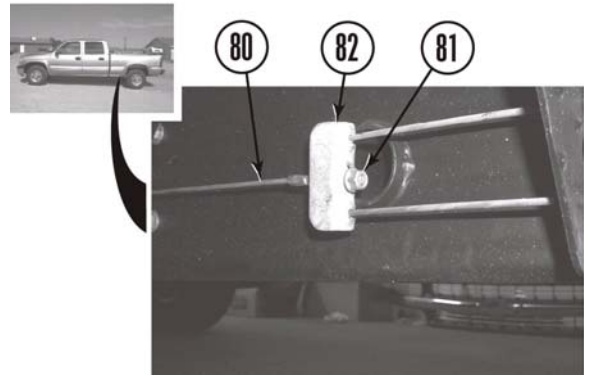

- i. Bend up two clips (83 and 84) on frame (20) passenger side.

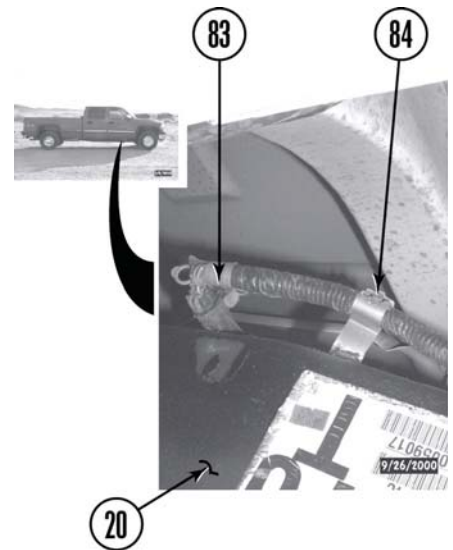

5. Remove the fuel filler.

⚠WARNING
 Use extreme caution when working near fuel lines and fuel tank. Clean up spilled fuel immediately. Any spark could cause an explosion or fire resulting in serious personal injury and property damage.

- a. Remove gas cap (85).
- b. Remove three bolts (86) from bed (87) and fuel filler (88).

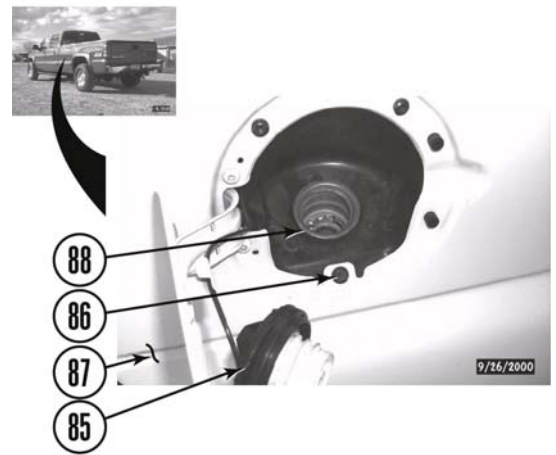

6. Remove the rear bumper.

- a. Measure distance between rear bumper (109) and tailgate (110).
- b. Remove lock (111) from spare tire winch tube (112).
- c. Disconnect two license plate lights (113) from rear bumper (109).

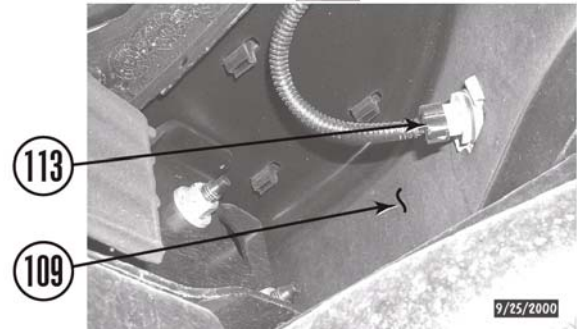
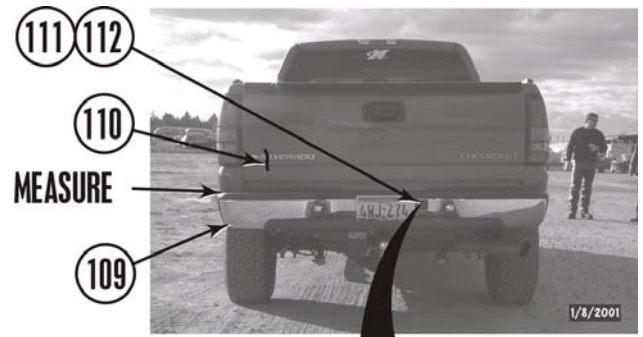

- d. Remove three clips (114) and harness (115) from rear bumper (109).

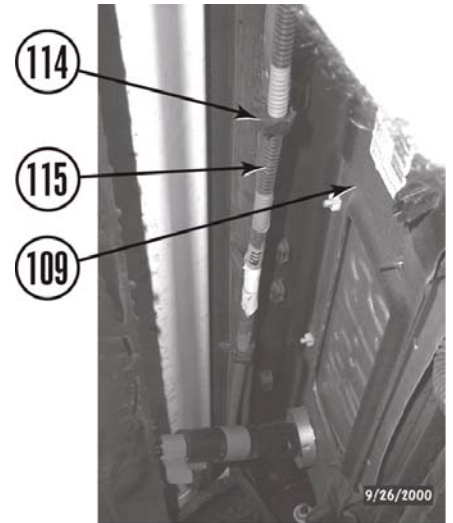

e. Remove two bolts with captive washers (116), four nuts with captive washers (117), and two double stud fasteners (118) from two rear bumper brackets (119), two rear side bumper brackets (120), and frame (20).

f. If equipped with a trailer hitch (121), remove four bolts (122 and 123) from hitch and frame (20).

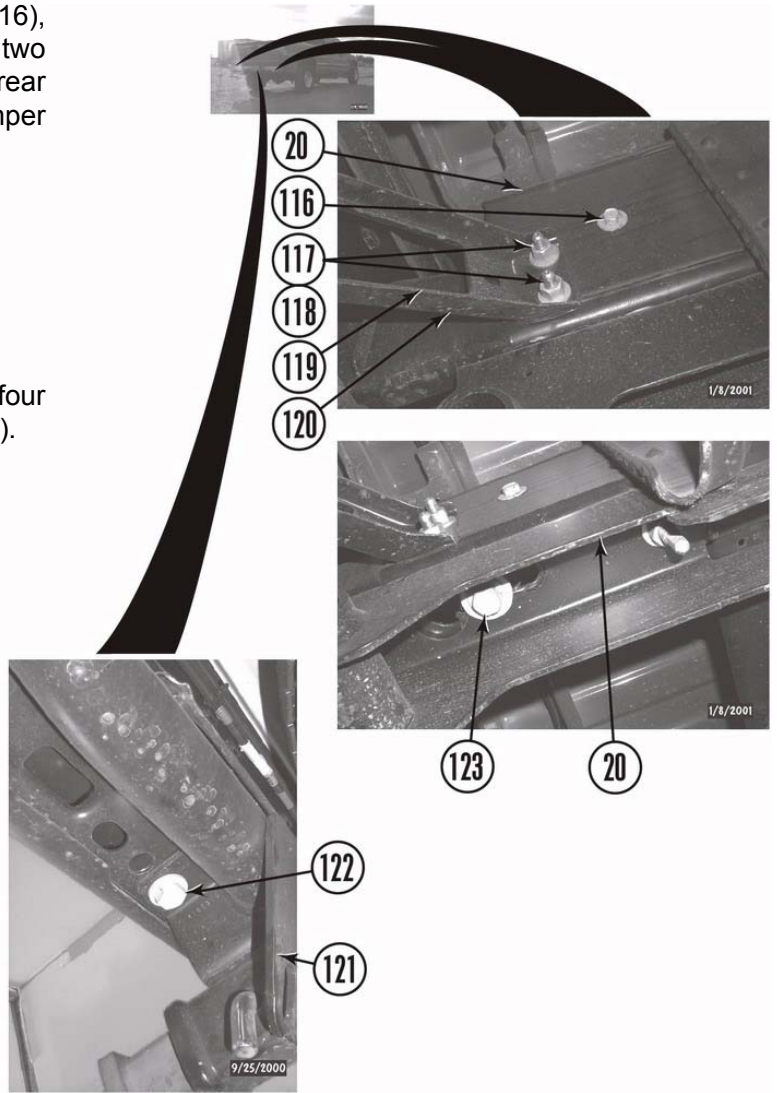

g. Remove two rear bumper brackets (120) and rear bumper (109) from frame (20).

h. Remove four nuts with captive washers (123), four bolts with captive washers (124), and two rear bumper brackets (120) from rear bumper (109).

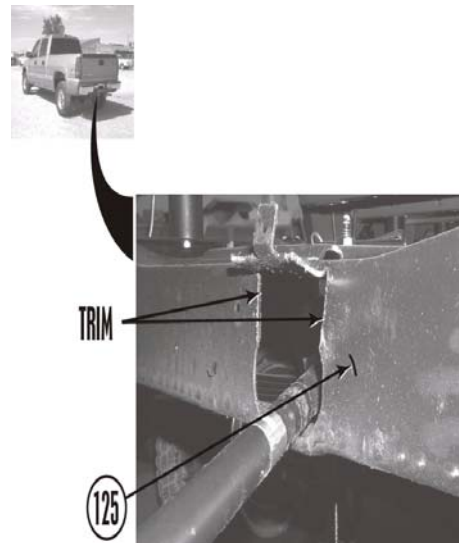

C. Install the kit.

1. Prepare to lift cab from frame.

⚠WARNING

Failure to replace the OEM cab mounting hardware (except mounting bolts in the kit) in the stock locations could result in serious personal injury or damage to the vehicle.

⚠NOTE

Depending on model year, some washers used with cab bolts may be captive washers and some may be standard washers. Standard washers are to be used during reassembly.

- a. Measure distance between the cab and the bed. Record measurement for later cab to bed alignment reference in these instructions.
- b. Loosen (do not remove) four cab mounting bolts (89 and 92) (one bolt at core support mount and three bolts at cab mounts (99).

⚠WARNING

Use extreme caution when lifting cab from frame. Ensure lifting device is securely placed. Keep hands out from between frame and cab, or serious personal injury could result.

⚠CAUTION

Continually check hoses, wires, lines, etc. to be sure that everything is flexing properly and not binding, or damage to the vehicle could result. Be especially careful of the a/c hoses at the firewall, the belt pulley, and at the core support. Ensure brake lines stretch while lifting. Bending the lines to gain ample slack may be necessary. Be extremely careful not to kink the lines.

- c. While lifting, ensure two power steering lines (93 and 94) are not becoming too taut. If lines are too taut, carefully bend lines to gain some slack.

⚠NOTE

Install the *kit* lift blocks on top of the original cab bushings. The *kit* lift blocks must be installed in addition to the original cab bushings.

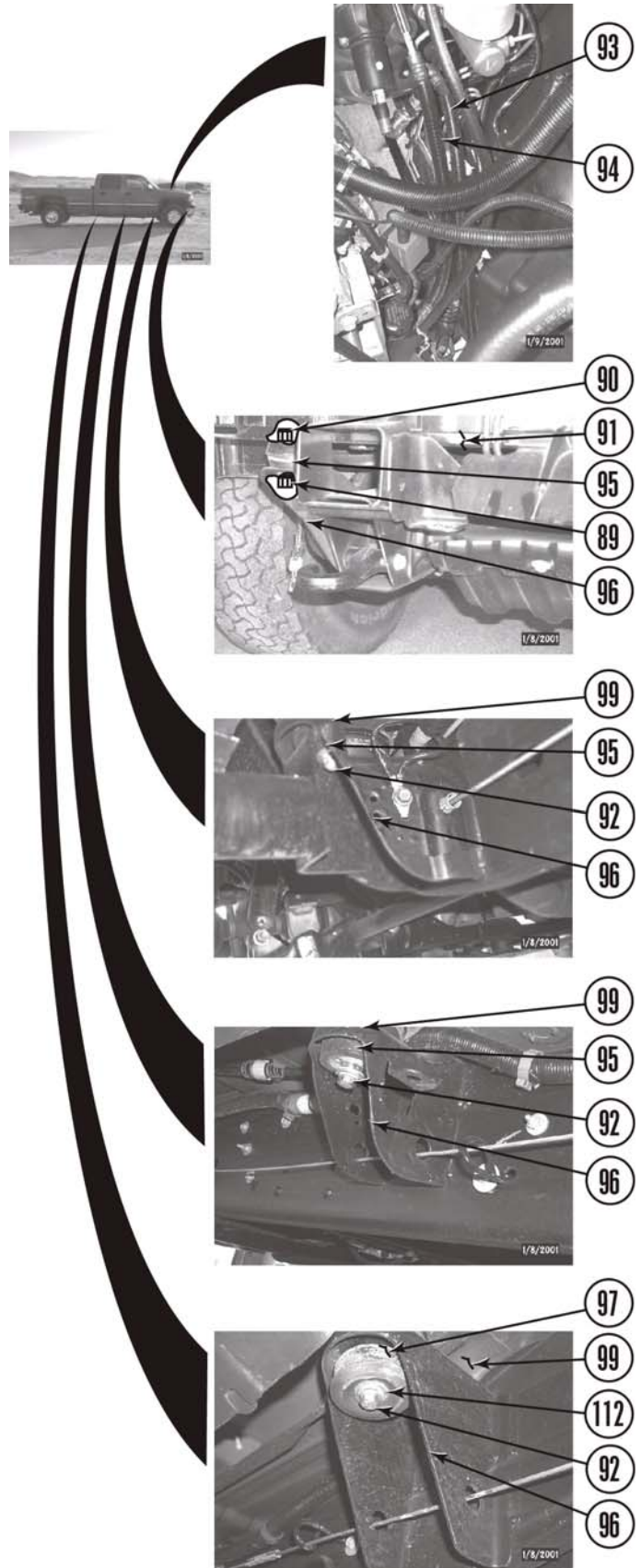

d. Remove nut with captive washer (90), bottom bushing (95), and bolt with captive washer (89) from the passenger side core support mount (96).

e. Remove three bolts with captive washers (92), bottom bushings (95 and 97), and two rear bushing washers (98) from the passenger side cab mounts (96).

2. Lift the cab.

a. Using a hydraulic jack and a wooden block, slowly lift the passenger side of the cab a little more than 2" (PA10092) or 3" (PA10093).

3. Install *kit* lift blocks on passenger side of cab.

a. Set the appropriate *kit* lift block (101) on top of the metal cup (102) at the core support mount (89) and three cab mounts (92).

(90) Block, lift, 2" height x 3" diameter (PA10092)
 (91) Block, lift, 3" height x 3" diameter (PA10093)

b. At the core support mount, install the appropriate *kit* bolt (103) through a *kit* 7/16" USS washer (104), frame (96), top bushing (105), metal cup (102), *kit* lift block (101), core support (91), *kit* 1/2" thick washer (106), and stock nut (90). LEAVE THE BOTTOM BUSHINGS (95) OFF FOR NOW. Do not tighten.

- Bolt, 12mm-1.75 x 160mm (PA10092)
- Bolt, 12mm-1.75 x 180mm (PA10093)

c. At three cab mounts, install the appropriate *kit* bolt (103) through a *kit* 7/16" USS washer (104), frame (96), top bushing (105), metal cup (102), *kit* lift block (101), and into the cab (99). LEAVE THE BOTTOM BUSHINGS (95 and 97) OFF FOR NOW. Do not tighten.

- Bolt, 12mm-1.75 x 160mm (PA10092)
- Bolt, 12mm-1.75 x 180mm (PA10093)

d. Lower the cab on the *kit* lift blocks.

4. Install *kit* lift blocks on driver side of cab.

a. Repeat the previous steps to install *kit* lift blocks on driver side of cab.

5. Finish the cab *kit* lift block installation.

a. Remove eight *kit* bolts (103) one at a time, coat threads with Loctite®, INSTALL THROUGH THE BOTTOM BUSHINGS (95 and 97) AND TWO REAR BUSHING WASHERS (98) NOW, and reinstall. Tighten to 55 lb-ft.

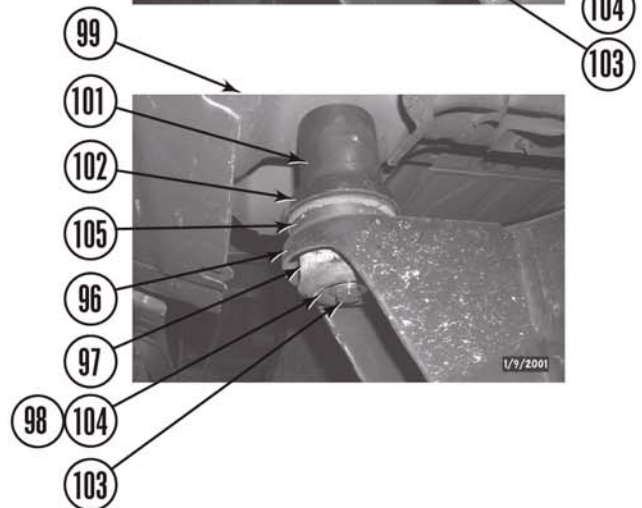
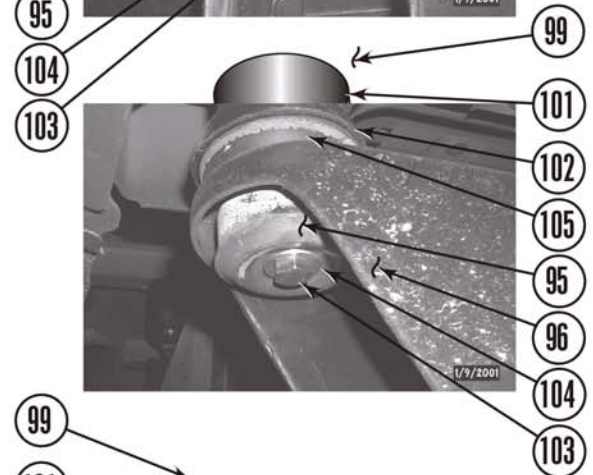
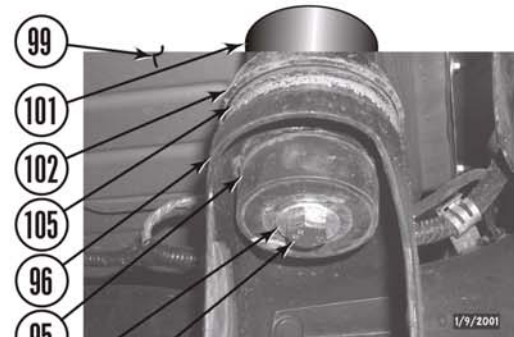
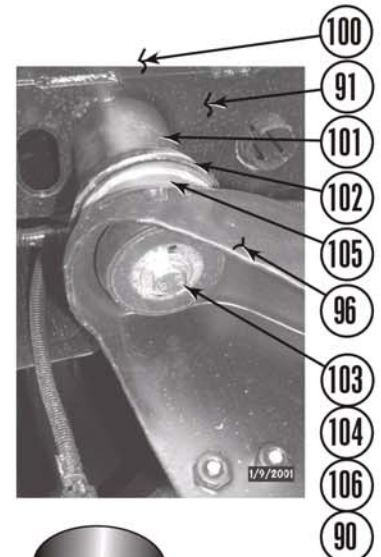

6. Install *kit* lift blocks on passenger side of bed.

- a. Loosen (do not remove) four bed mounting bolts (107) on driver side of bed.
- b. Remove four bed mounting bolts (107) from passenger side of bed (87).

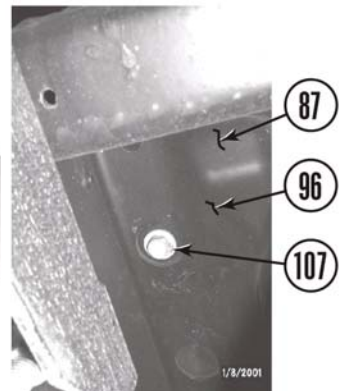
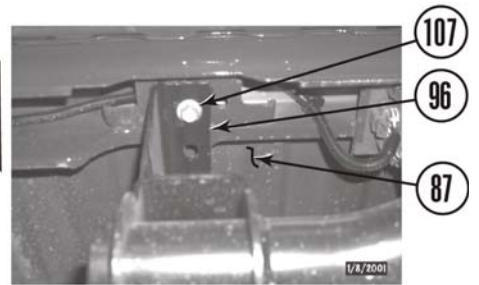
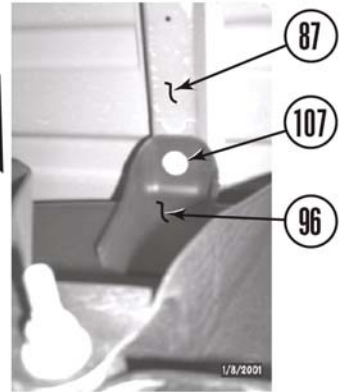
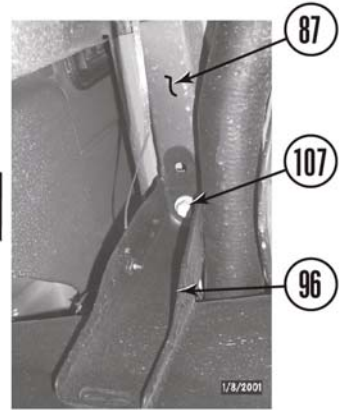

- c. Using a hydraulic jack and a wooden block, slowly lift the passenger side of the bed a little more than 2" (**PA10092**) or 3" (**PA10093**).
- d. At the rearmost bed mount, set the appropriate *kit* lift block on the frame (96).
 - Block, lift, 2" height x 2" diameter, with 1/2" bolt hole (**PA10092**)
 - Block, lift, 3" height x 2" diameter, with 1/2" bolt hole (**PA10093**)

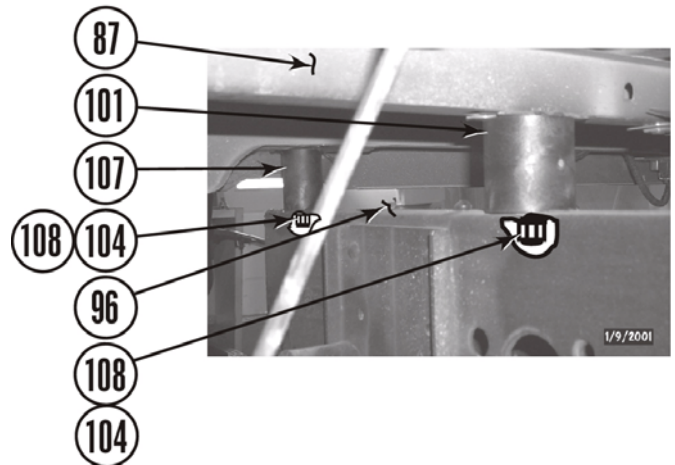
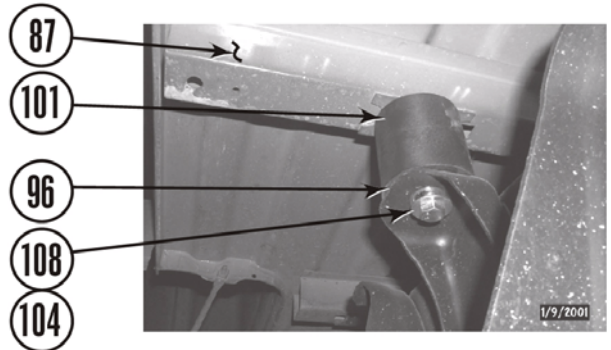
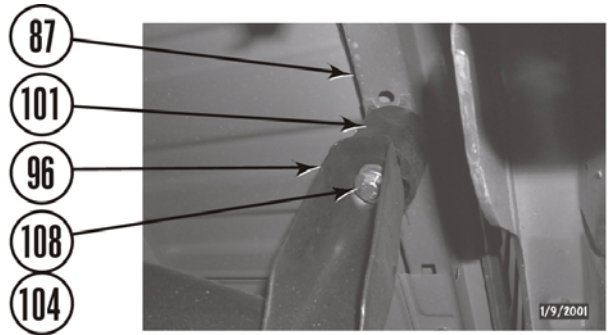

NOTE
Kit lift blocks (2" diameter with 5/8" bolt hole) are for the rear bumper and hitch.

- e. At the other bed mounts, set the appropriate *kit* lift block on the frame (96).
 - Block, lift, 2" height x 3" diameter (**PA10092**)
 - Block, lift, 3" height x 3" diameter (**PA10093**)
 - f. At each bed mount, install the appropriate *kit* bolt (108) through a *kit* 7/16" USS washer (104), frame (96), *kit* lift block (101 and 107), and into the bed (87). Do not tighten.
 - Bolt, 12mm-1.25 x 80mm (**PA10092**)
 - Bolt, 12mm-1.25 x 100mm (**PA10093**)
 - g. Lower the bed onto the *kit* lift blocks.
7. Install *kit* lift blocks on driver side of bed.
- a. Repeat the previous steps to install *kit* lift blocks on driver side of bed.
8. Finish the bed *kit* lift block installation.
- a. Adjust the cab to bed clearance using the measurements recorded earlier.
 - b. Remove eight bed mounting bolts (108) one at a time, coat threads with Loctite®, and reinstall. Tighten to 55 lb-ft.

9. Install the rear bumper.

⚠WARNING

The following procedure is intended only to enhance the appearance of the vehicle. The rear bumper will no longer be rated for towing of any kind. Towing with the rear bumper after it has been lifted can result in death, serious personal injury, or damage to the vehicle. Towing after the bumper has been lifted should be accomplished using a rated Class III receiver type hitch.

- a. Trim spare tire carrier (125) as shown.

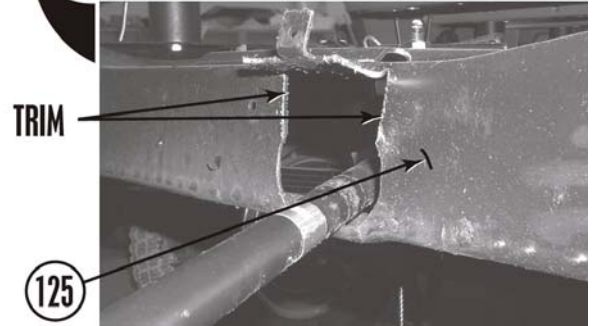

- b. Coat threads of bolts (122, 124, 128, 133 and 140) and nuts (123, 130, 132, 135 and 137) with Loctite®.
- c. Install two *kit* rear bumper main brackets (126) on rear bumper (109) with four bolts (124) and nuts (123). Do not tighten.
- d. Position two *kit* rear bumper main brackets (126), rear side bumper brackets (119), and *kit* rear bumper small studded brackets (127) in frame (20) rails. Ensure spare tire winch tube (112) fits in original hole in rear bumper. Install two *kit* 7/16" x 1 1/2" bolts (128), four *kit* 7/16" USS washers (129), two *kit* 7/16" nylock nuts (130), six *kit* 1/2" USS washers (131), six *kit* 1/2" nylock nuts (132), two *kit* 3/8" x 1 1/2" bolts (133), four *kit* 3/8" USS washers (134), and two *kit* 3/8" nylock nuts (135). Do not tighten.

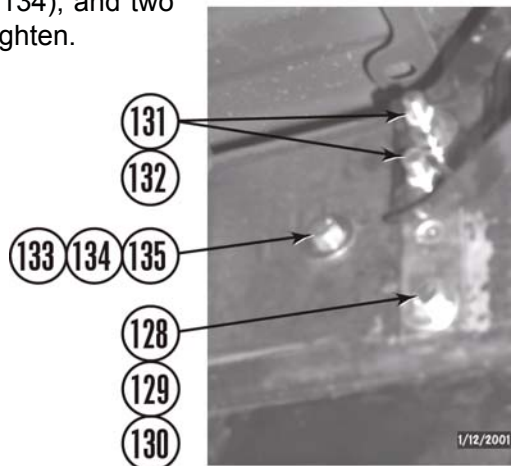
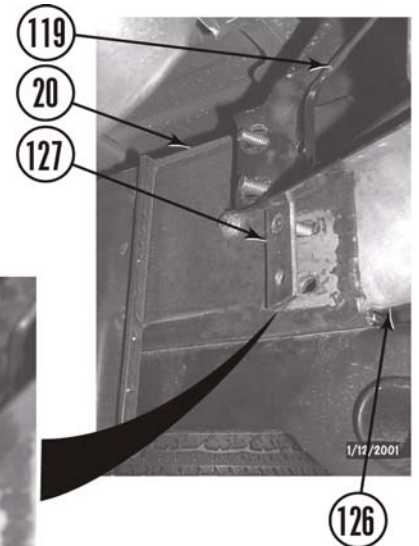

- e. If equipped with a trailer hitch (121), install hitch on frame (20) with four bolts (122), two *kit* 1 1/2" x 1 1/2" rectangular washers (136), and two *kit* 14mm nylock nuts (137). Do not tighten.

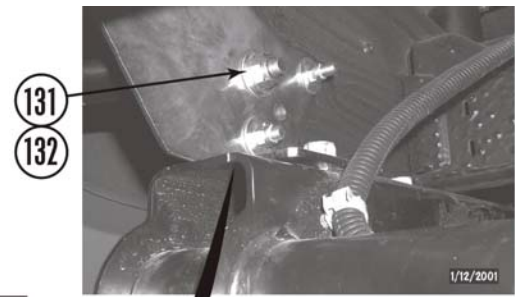
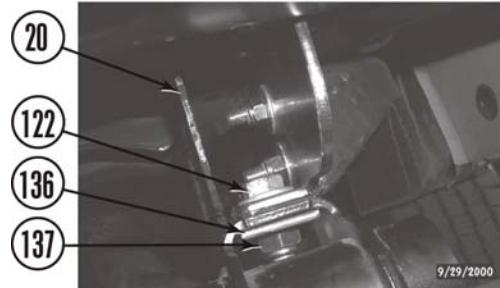

- f. Install two of the appropriate *kit* lift blocks (138) on rear bumper (109) and hitch (121) with two *kit* 14mm washers (139) and two of the appropriate *kit* bolts (140).

- Block, lift, 2" height x 2" diameter, with 5/8" bolt hole (**PA10092**)
- Bracket, rear bumper middle (**PA10093**)
- Bolt, 14mm-2.00 x 90mm (**PA10092**)
- Bolt, 14mm-2.00 x 110mm (**PA10093**)

Kit Bracket
(Rear Bumper
Middle)

Kit Bolts
(14mm x 110mm)

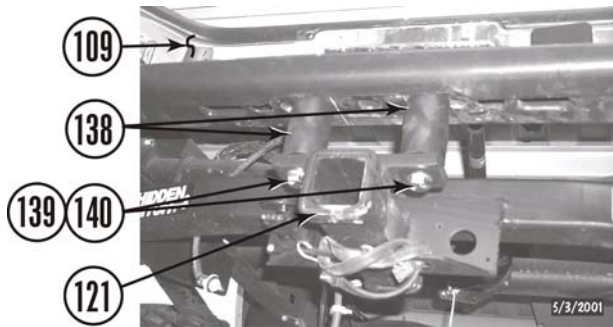

- g. Adjust bumper to body clearance and tighten bolts (122, 124, 128, 133 and 140) and nuts (123, 130, 132, 135 and 137) to 55 lb-ft.

- h. Install three clips (114) and harness (115) on rear bumper (109).

- i. Connect two license plate lights (113) in rear bumper (109).

- j. Install lock (111) in spare tire winch tube (112).

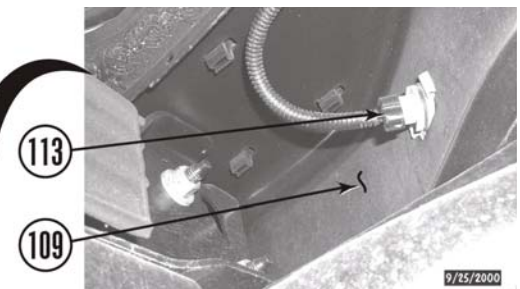
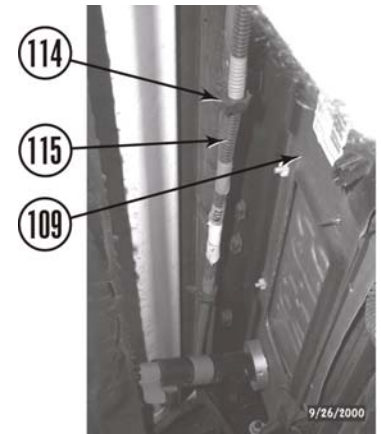

10. **2003 Models:** Install fuel filler.

⚠WARNING

Use extreme caution when working near fuel lines and fuel tank. Clean up spilled fuel immediately. Any spark could cause an explosion or fire resulting in serious personal injury and property damage.

- a. Remove clamp (141) and filler hose (142) from gas tank (143). Leave ground wire (144) and vent hose (145) attached.

- b. Carefully cut filler hose (142) in half where shown. **ENSURE YOU DO NOT CUT THROUGH PLASTIC TUBE (146) INSIDE FILLER HOSE.**

- c. Install *kit* fuel filler extension (147) on filler hose (142) with two *kit* #36 clamps (148).

- d. Install filler hose (142) on gas tank (143) with clamp (141).

- e. Install fuel filler (88) on the bed (87) with three bolts (86).

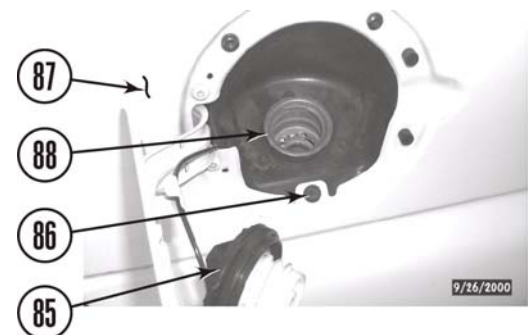
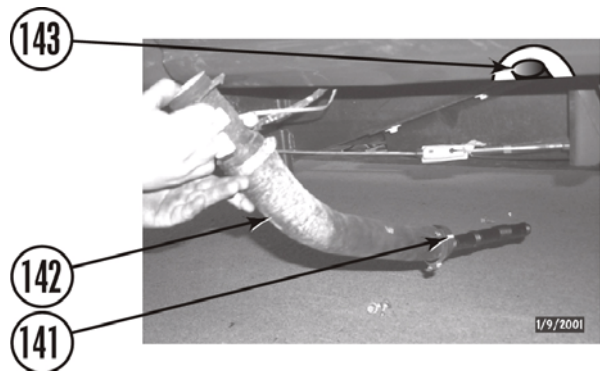
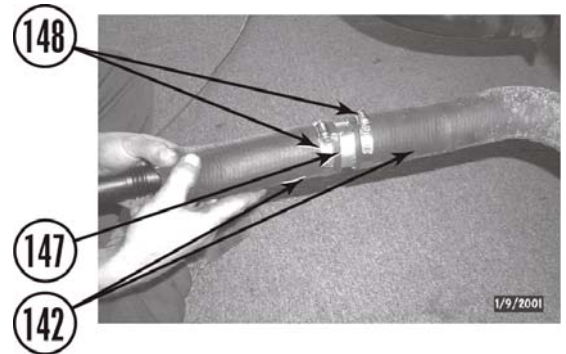
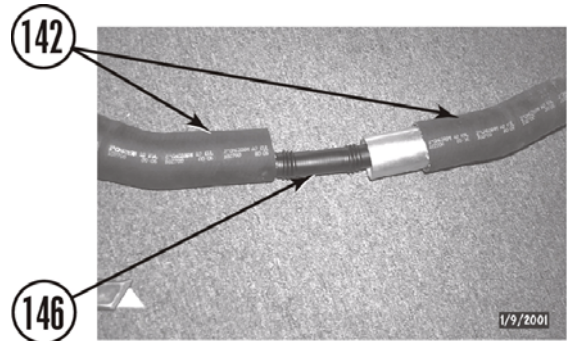
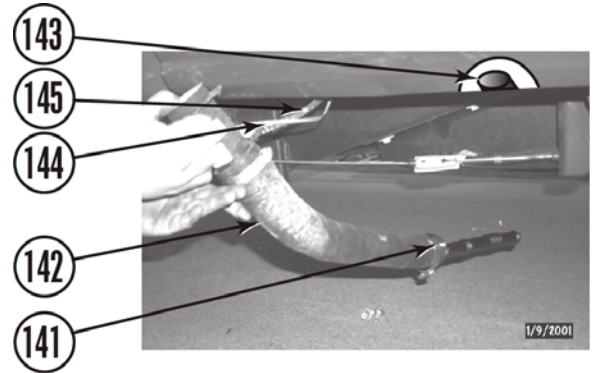

f. Install gas cap (85).

11. **2004 Models:** Install fuel filler

⚠WARNING

Use extreme caution when working near fuel lines and fuel tank. Clean up spilled fuel immediately. Any spark could cause an explosion or fire resulting in serious personal injury and property damage.

a. Remove bolt and fuel filler ground wire from frame.

Bolt & Ground Wire

Frame



b. Loosen fuel filler hose and vent hose clamps.

Clamps

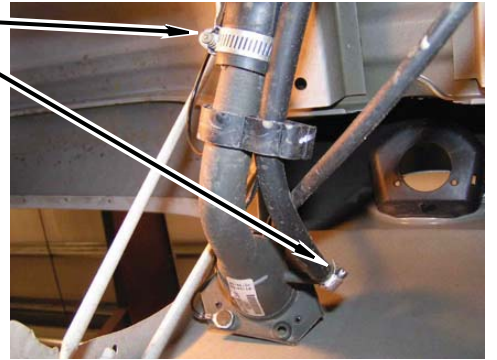

c. Remove clips from vent hose and fuel filler hose.

Clips



d. Remove fuel filler from vehicle.

e. Mark and cut fuel filler neck as shown.

Alignment Mark

Cut Here

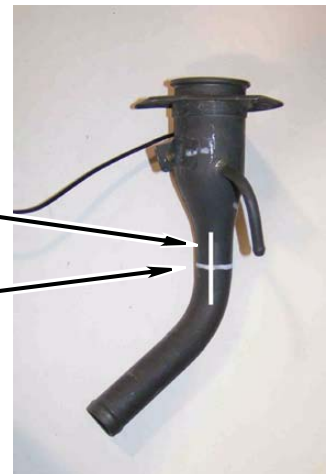

- f. Deburr edges of cut ends.
- g. Install kit extension (fuel filler) with two kit clamps (#20 hose). DO NOT TIGHTEN.

Kit Clamps
(#20 Hose)

Kit Extension
(Fuel Filler)

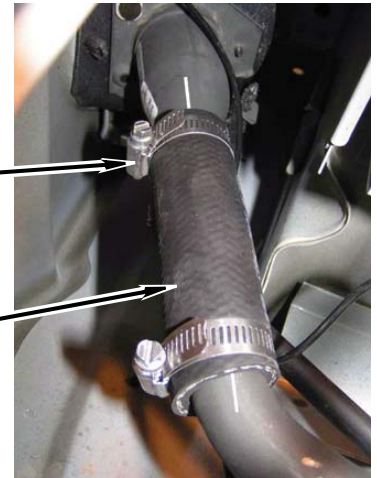

- h. Install fuel filler onto body with three bolts.

Bolts



- i. Install fuel filler onto fuel filler hose. Adjust *kit* extension (fuel filler, rubber) and fuel filler hose. TIGHTEN *kit* clamps (#20 hose) and fuel filler hose clamp. Install fuel filler vent hose onto fuel filler and TIGHTEN vent hose clamp.

Fuel Filler

Fuel Filler Hose

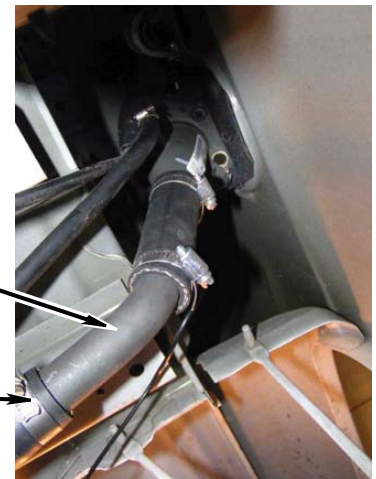

- j. Install clips onto fuel filler and vent hose.

Clips



- k. Install ground wire onto frame with bolt.
- l. Install fuel cap.

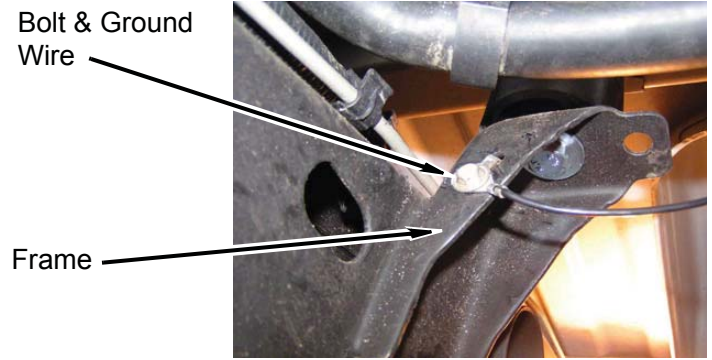

12. Along the frame rails.

- a. If possible, install two clips (78 and 79) and harness (77) on frame (20) driver side.

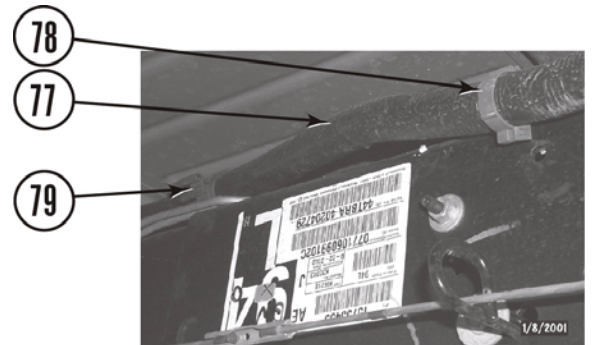

- b. Drill 1/2" hole 2" up and 1/2" to left of original parking brake cable hole.

Drill 1/2" Hole Here

Original Parking Brake Cable Hole

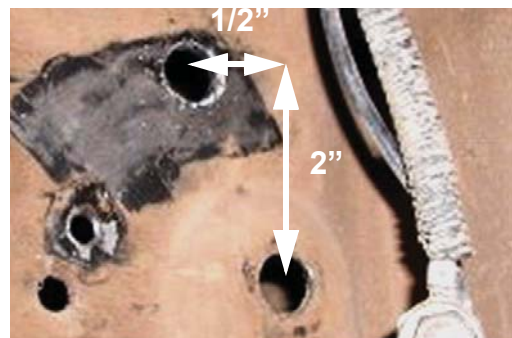

- c. Bend tab on frame mounting pad up.

Tab

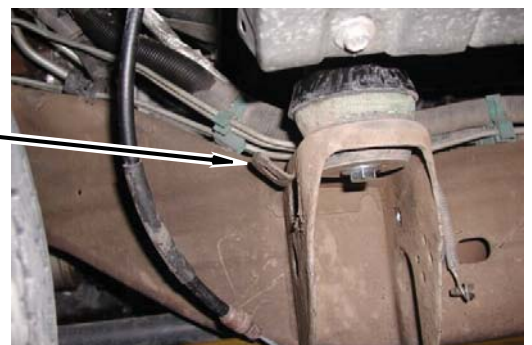

d. Install front parking brake cable housing.

Parking Brake Cable Housing



e. Install two ground wires onto frame mounting pad with bolt. Connect front and rear parking brake cables. Remove clamps from rear parking brake cable.

Ground Wires & Bolt



f. If possible, install two brake lines (70) in pop-up clip (71).

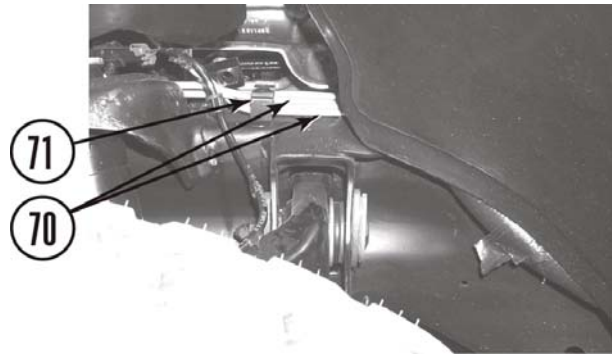

- g. If possible, install four clips (65, 66, 67, and 68) in frame (21) driver side and wheel well (69).
- h. If possible, install harness (64) and clip (63) in frame (20) driver side.
- i. If possible, install clip (61) in bracket (62).

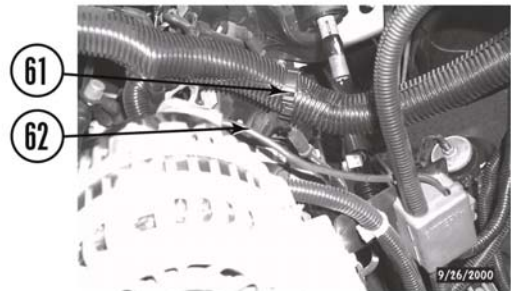
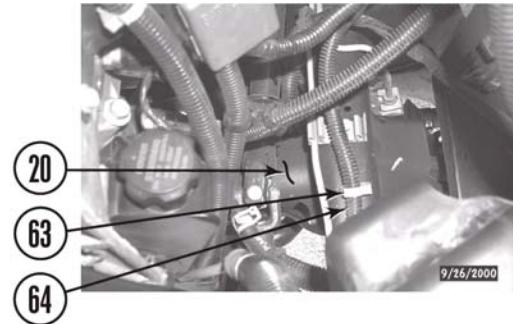
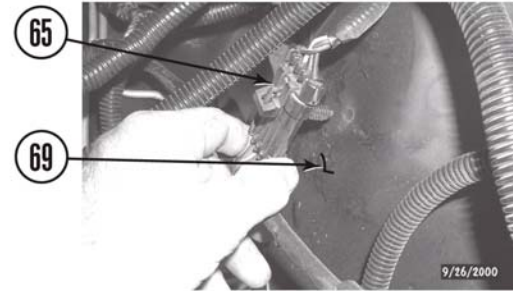
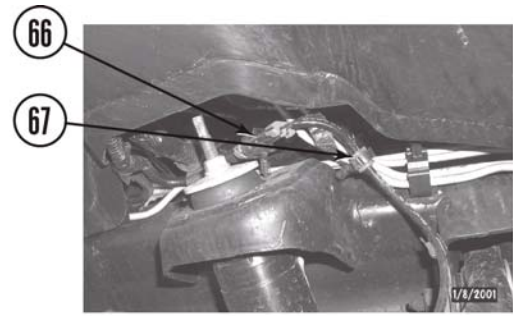
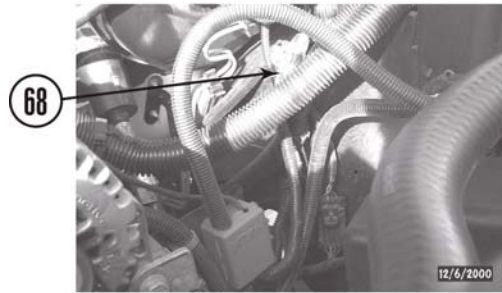

- j. **Singe cab:** Install two *kit* cab safety cable extension brackets on frame rear mounting pads with two bolts.
- k. Install two safety cables on *kit* brackets with two *kit* 3/8" x 1 1/2" bolts, four *kit* 3/8" USS washers, and two *kit* 3/8" nylock nuts.

Kit Cab Safety Cable Extension Bracket (1 1/2" x 4 3/4")

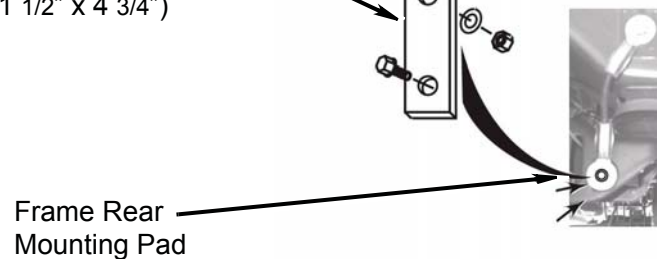

13. Under the cab.

NOTE

This step is for vehicles with automatic transmission only. Other models skip this step.

- a. Ensure automatic transmission cable (153) has enough slack and is not pulling on boot (154) or binding. If cable is pulling or binding, remove cable from clip (155).

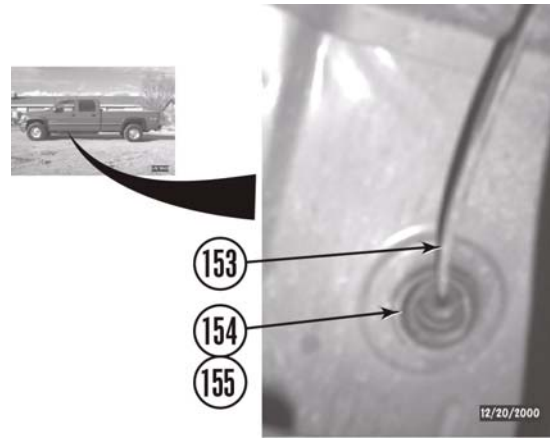

14. Lengthen and install manual transmission shift lever.

NOTE

Extension of the manual transmission shift lever requires *kit* extension (SE4701, sold separately).

- a. Remove four screws (156) and four pop-ups (157) from floorboard (159). (It may be necessary to cut pop-ups.) Slide shift boot (158) up onto shift lever.

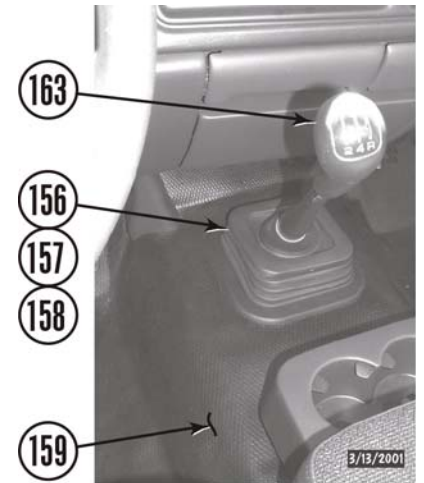

- b. Loosen jam nut on input lever. Remove shift lever from input lever.



- c. Install *kit* extension (SE4701, sold separately) on input lever. Rotate *kit* extension until it is in the best position for shifting (about 45° from center-line of transmission), then tighten jam nut.



Kit Extension (SE4701, sold separately)

- d. Install shift lever on *kit* extension.



Shift Lever

- e. Check transmission shift lever operation. Ensure there is complete engagement in all gears.

- f. Install shift boot (158) on floorboard (159) with four screws (156). Check transmission shift lever operation again.

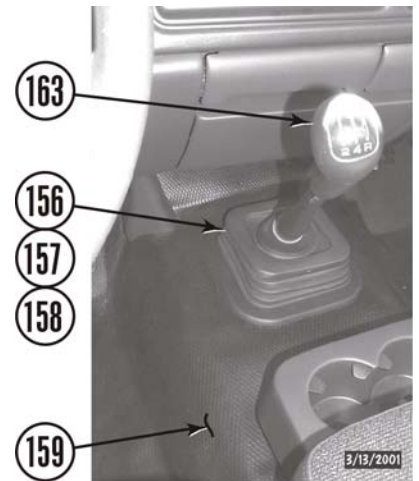

15. Lengthen and install transfer case shift linkage rod.

NOTE

This step is for vehicles with manual-shift transfer case. Vehicles with automatic-shift transfer case skip this step.

- Remove three lines (167) from bracket (168). Remove two nuts (169) and bracket (168) from transfer case (170).
- Remove two clips (171) and transfer case linkage rod (172) from transfer case (169) and pivot (173).
- Scribe a line along the axis of the linkage rod (172) as shown. Cut the linkage rod into two pieces through the line and deburr as necessary.

WARNING

A certified welder should perform all welding.

- Position *kit* transfer case shift linkage extension (174) between the two pieces of linkage rod (172). Ensure scribed lines on *kit* extension and linkage rod are aligned, then weld the *kit* extension in place.
- Install linkage rod (172) on transfer case (167) and pivot (173) with two clips (171).
- Check transfer case shift lever operation. Ensure there is complete engagement in all ranges. If necessary, adjust the linkage.

16. Under the hood.

- Install *kit* ground strap bracket (175) on stud (60) with nut (58). Install ground strap (59) on *kit* ground strap bracket (175) with *kit* 1/4" x 1" bolt (176), two *kit* 1/4" SAE washers (177), and *kit* 1/4" nylock nut (178).

17. Install *kit* steering extension.

WARNING

Ensure *kit* steering extension is installed properly and bolts are torqued according to Performance Accessories specifications.

- Coat threads of retaining bolts (54 and 180) with Loctite®.
- Install *kit* steering extension (179) on upper steering shaft (56) with *kit* 3/8" x 1 3/4" retaining bolt (180), two *kit* 3/8" SAE washers (134), and *kit* 3/8" nylock nut (135). Do not tighten.

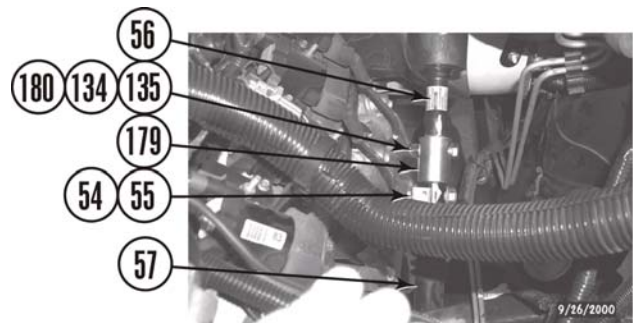
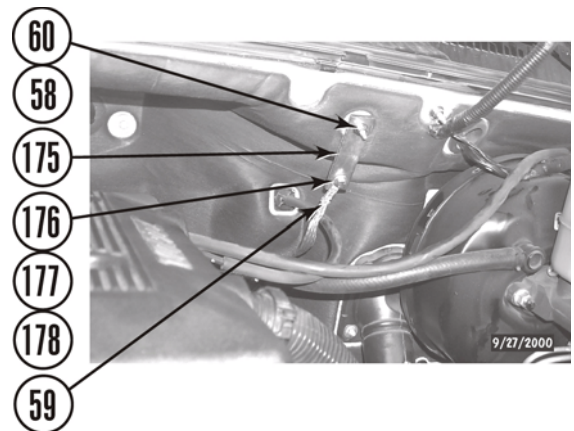
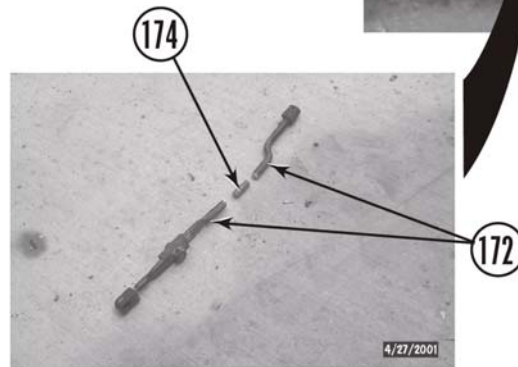
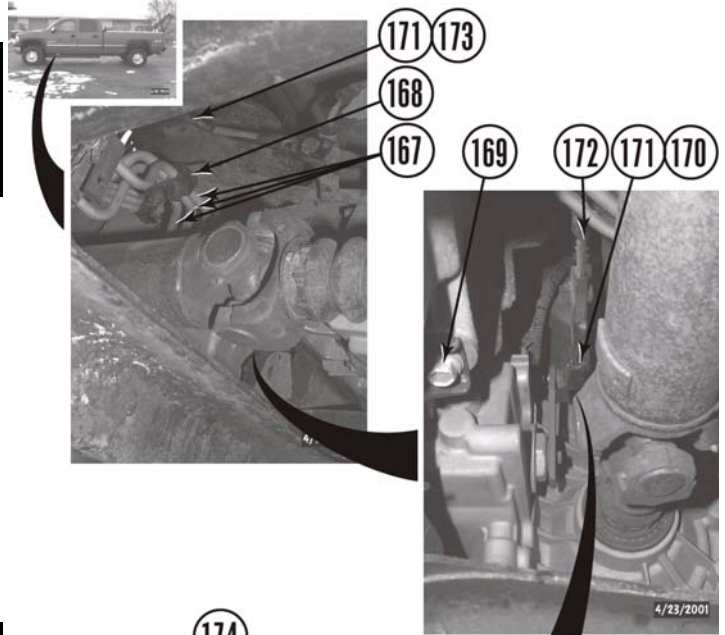

- c. Install lower steering shaft (57) on *kit* steering extension (179) with the stock retaining bolt (54) and clip (55).
- d. Tighten bolts (54 and 180) to 33 lb-ft.

18. Radiator.

- a. Trim ears off of the sides of the lower half of the fan shroud (49).
- b. Mark and trim upper fan shroud as shown.

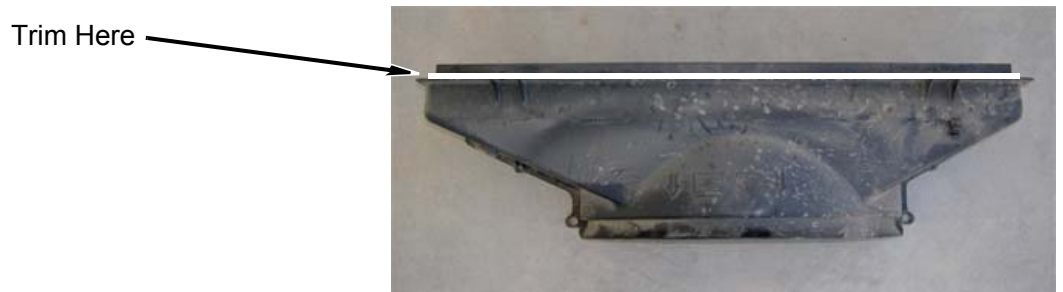
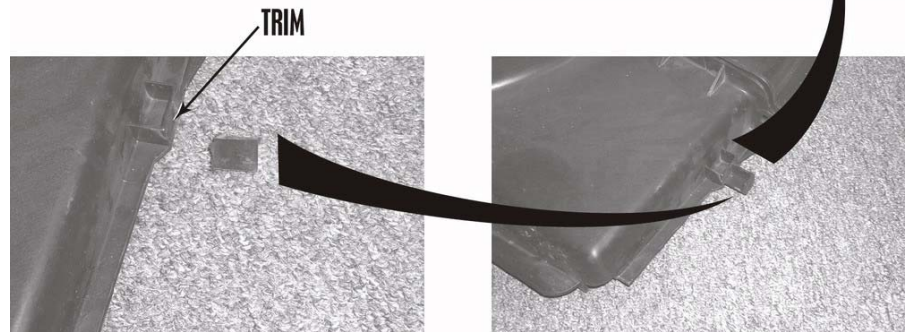

- c. Set lower and upper halves of fan shroud into position in engine compartment. Attach upper and lower halves of fan shroud to each other using the pop-ups.
- d. Install *kit* brackets and kit urethane radiator onto fan shroud using *kit* 1/4" nylock nuts and *kit* 1/4" SAE washers. (For 2" kit, holes will need to be drilled in kit urethane radiator).

Kit Urethane

Kit Brackets

Kit Nuts & Washers

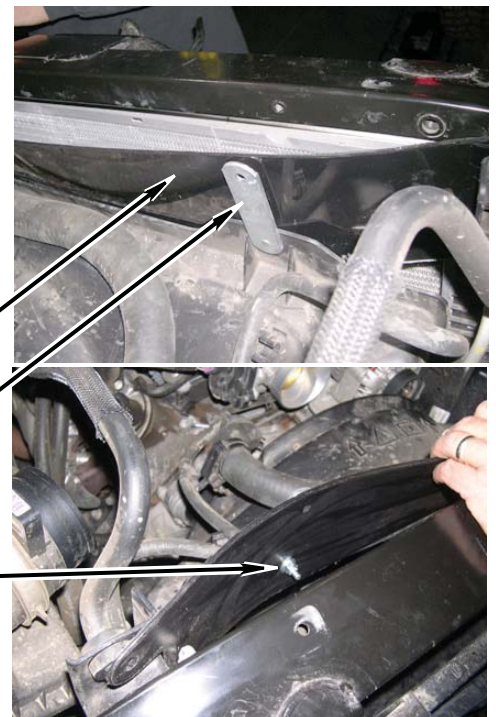

- e. Install two *kit* fan shroud upper brackets on core support with original bolts. (On 8.1L, install four *kit* brackets.)

CAUTION

Use care when drilling hole into core support. DO NOT drill into radiator. Severe damage could occur.

Bolts



- f. Drill 1/4" hole through kit urethane radiator into upper core support. Install kit push clip into kit urethane radiator and upper core support.
- g. Remove four clips holding wire harness to bottom of core support. Remove four clips from wire harness.

Drill & Install
Kit Push Clip



- h. **PA10092:** Drill two 9/32" holes in vertical face of **PA10092** core support where *kit* fan shroud lower brackets ("L") will be installed.

Drill

Drill



- i. **PA10093:** Using kit brackets (L-shaped) as templates, mark two holes in lower fan shroud as shown. Using kit brackets (L-shaped) as templates, mark two holes in lower core support as shown.

Kit Bracket
(L-Shaped)

Mark & Drill Here

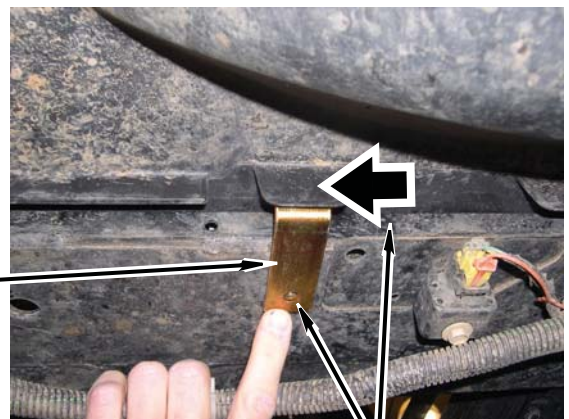

- j. Install *kit* fan shroud lower brackets on core support using *kit* 1/4" fasteners. Using the hole in each *kit* lower bracket as a template, mark the fan shroud for drilling.
- k. Remove fan shroud. Drill holes in lower half of fan shroud where marked. Set both halves of fan shroud into position in engine compartment and attach them to each other using pop-ups.
- l. Secure upper half of fan shroud to *kit* upper brackets.
- m. Secure lower half of fan shroud to *kit* lower brackets using *kit* 1/4" fasteners. Be sure to install two *kit* wire harness clamps on wire harness.
- n. Check fan to fan shroud clearance. Ensure gap is the same all around shroud, then tighten all bolts and nuts.
- o. Position air duct (43) on air filter housing (44) and throttle body (45) and tighten two clamps (41 and 42).
- p. Install hose (36) in two clamps (37 and 38).
- q. Install hose (39) in clamp (40).

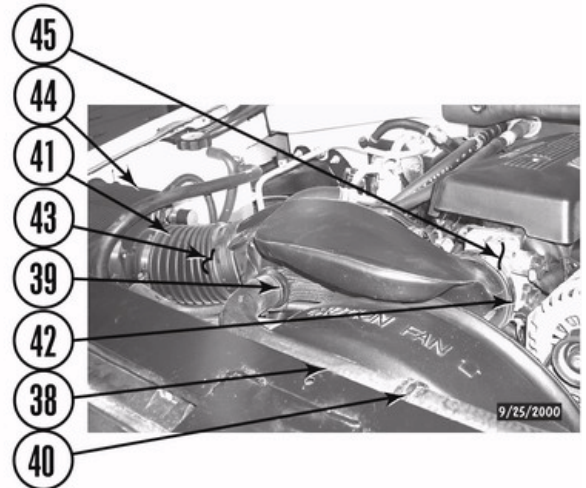
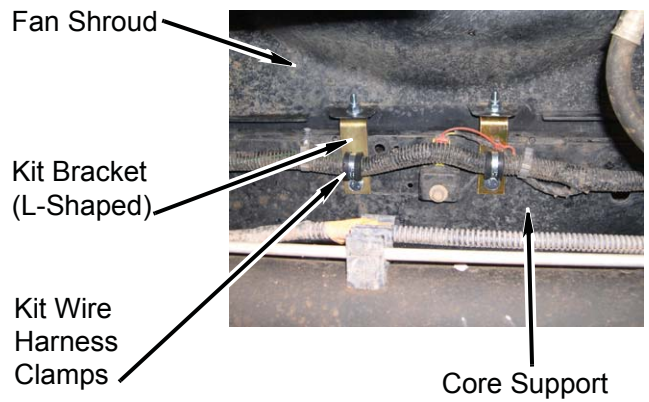

19. Transmission cooler (if so equipped).

- a. Install two *kit* transmission cooler "S" brackets with stud (186) on two clip nuts (35) on core support (9) with bolts (29). Do not tighten.
- b. Install transmission cooler (31) on two *kit* brackets (186) with two *kit* 1/4" SAE washers (177) and *kit* 1/4" nylock nuts (178). Do not tighten.
- c. Install two *kit* transmission cooler spacer tubes (187) with two 1/4" x 3" bolts (188), four 1/4" SAE washers (177), and two 1/4" nylock nuts (178).
- d. Tighten nuts (178) and bolts (30 and 188).
- e. Carefully bend hard line (32) as shown and secure with *kit* zip tie (189).

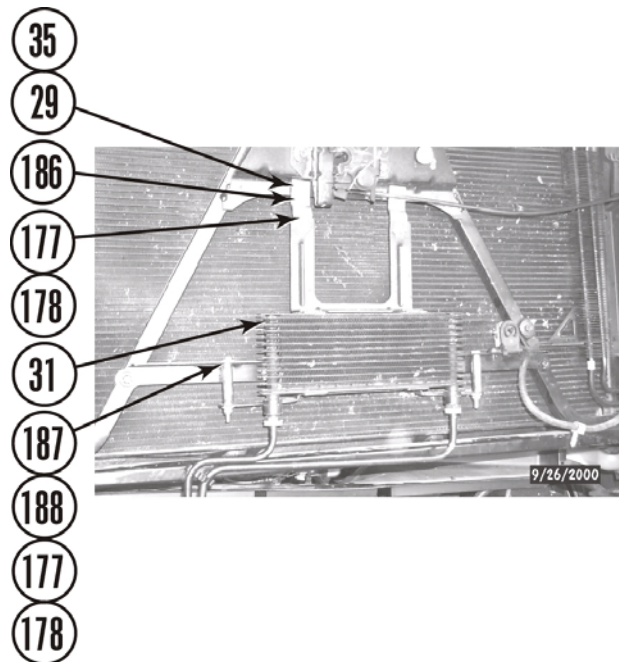

- f. Trim air flap (28) as shown if a test fit indicates it interferes with hard lines (32 and 33).
- g. Install air flap (28) on core support (9) with three panel clips (30).

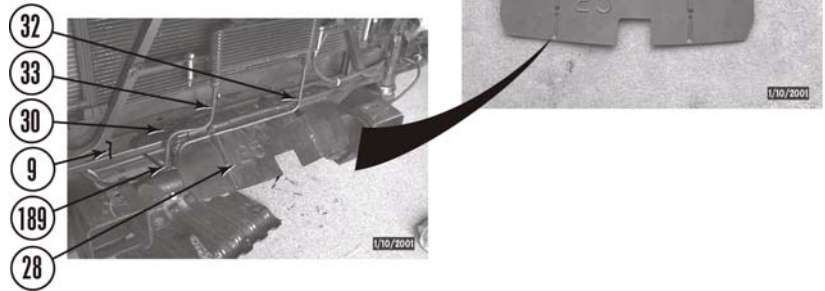

- h. Install plastic cover (26) on frame (20) and core support (9) with five bolts with captive washers (25).

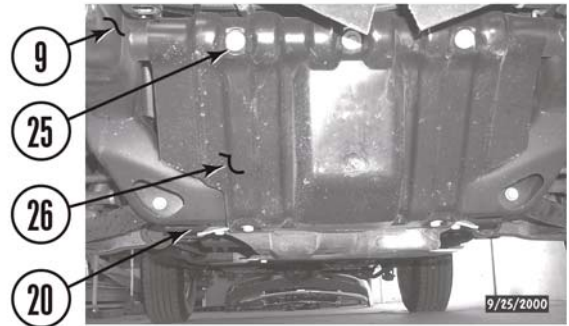

20. Install the front bumper.

NOTE
Some models may not require any cutting or trimming of the front bumper valance or front bumper brackets. Test fit bumper before proceeding.

- a. **Chevy Models:** Trim the front bumper valance (190) in two places as shown.
- b. **Chevy Models:** Trim two front bumper brackets as shown. Check fitment and trim as necessary.



Front Bumper Bracket

Trim Here



c. **GMC models:** Mark and cut driver side front bumper as shown

Cut Here



Cut Here



Cut Here

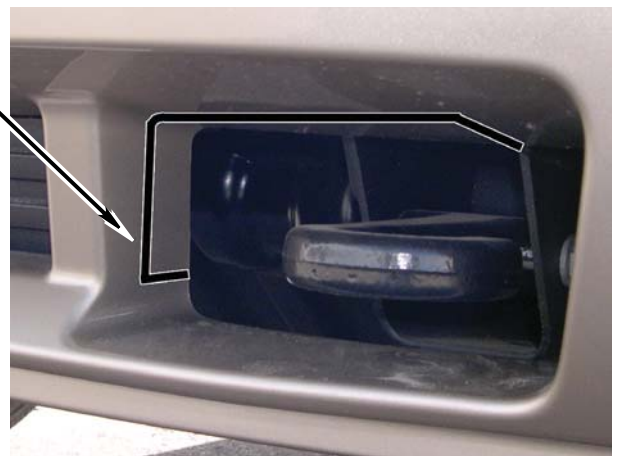
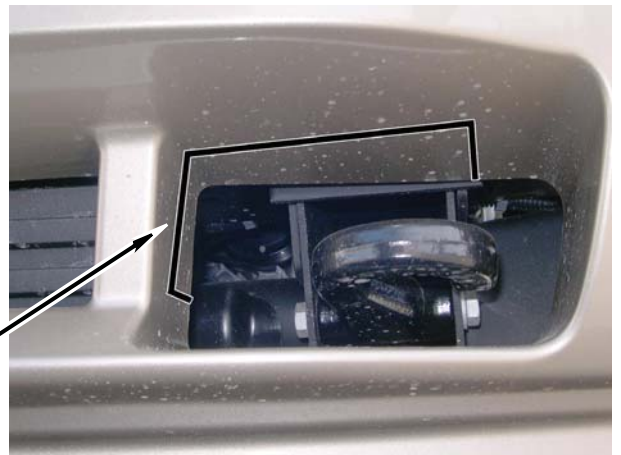

- d. **GMC models:** Repeat above step for passenger side front bumper. Check fitment and trim driver and passenger side, if necessary



NOTE

To install factory tow hooks, additional front bumper and/or valence modification is required. Tow hooks can not be installed on some models.

- e. Apply a small amount of kit Loctite® onto threads of bolts (19, 22, and 128) and nuts (130).
- f. Install two *kit* front bumper main brackets (191) on frame with two stock bolts (21), two *kit* 7/16" x 1 1/2" bolts (128), four *kit* 7/16" USS washers (129), and two *kit* 7/16" nylock nuts (130). Do not tighten



- g. Install *kit* front bumper inner brackets (192) on *kit* main brackets with four *kit* 7/16" x 1 1/2" bolts (128), eight *kit* 7/16" USS washers (129), and four *kit* 7/16" nylock nuts (130). Do not tighten.
- h. Install front bumper (15) on two *kit* main brackets (191) and two *kit* inner brackets (192) with two bolts (22), two *kit* 7/16" x 1 1/2" bolts (128), four *kit* 7/16" USS washers (129), and two *kit* 7/16" nylock nuts (130). Do not tighten.



- i. **PA10093:** Install front outer bracket to *kit bracket* (front bumper, outer) with two *kit bolts* (7/16" x 1-1/2") four *kit washers* (7/16" USS) and two *kit nuts* (7/16" Nylock). DO NOT TIGHTEN.
- ii. **PA10093:** Install *kit bracket* (front bumper, outer) onto passenger side frame with factory bolts. Apply a few drops of *kit Loctite®* to threads of factory bolt. DO NOT TIGHTEN.
- iii. **PA10093:** Apply a few drops of *kit Loctite®* to threads of factory bolt. Install front outer bracket to front bumper with factory bolt. DO NOT TIGHTEN.
- iv. **PA10093:** Repeat above steps for driver side of vehicle.

Kit Bolts
(7/16" x 1-1/2"),
Kit Washers
(7/16" USS),
Kit Nuts
(7/16" Nylock)

Front Outer
Bracket

Factory
Bolt

Kit Bracket
(Front
Bumper,
Outer)

Factory
Bolts

Front
Bumper



- m. **PA10092:** Install passenger side front outer bracket to front bumper with factory bolt.
- n. **PA10092:** Using passenger side front outer bracket as a template, drill two 1/2" holes through body mounting pad on frame.
- o. **PA10092:** Install passenger side outer bracket to frame with two *kit bolts* (7/16" x 1-1/2"), four *kit washers* (7/16" USS) and two *kit nuts* (7/16" Nylock). DO NOT TIGHTEN.
- p. **PA10092:** Repeat above steps for driver side of vehicle.
- q. If so equipped, install two connectors (16) on fog lamps (17).
- r. Tighten nuts (130) and bolts (18, 21, and 128). Check measurements between front bumper (15) and front fenders (14). Adjust bumper to cab clearance and tighten bolts and nuts to 55 lb-ft.

Drill Here

Passenger
Outer
Bracket

Factory
Bolt

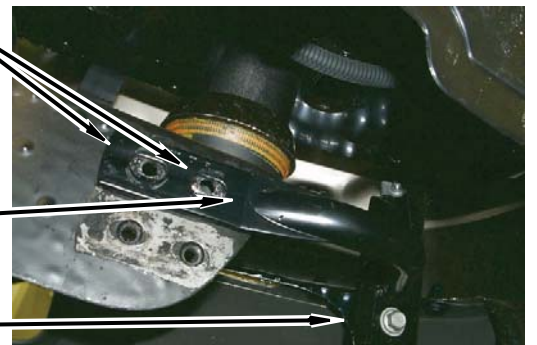

Kit Bolts
(7/16" x 1-1/
2"),
Kit Washers
(7/16" USS),
Kit Nuts
(7/16" Nylock)

Passenger
Outer
Bracket



21. Install the grille.

- a. Position grille (13) on core support (9) and install two clips (12) in front fenders (14).
- b. Tighten four phillips head/dzeus fasteners (11) and install bolt with captive washer (10).

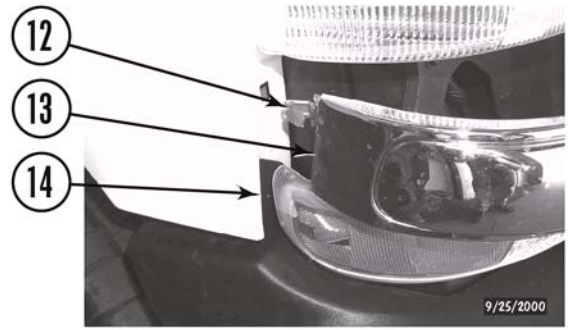

- c. Install cover (8) on core support (9) with seven panel clips (7).



22. Install crush blocks (metal bed spacers).

- a. Remove four rubber bumpers (194) from bed (87).
- b. Install four *kit* crush blocks (195) on bed (87) with four *kit* 5/16" USS washers (151) and four *kit* 5/16 x 1" self-tapping bolts (196).

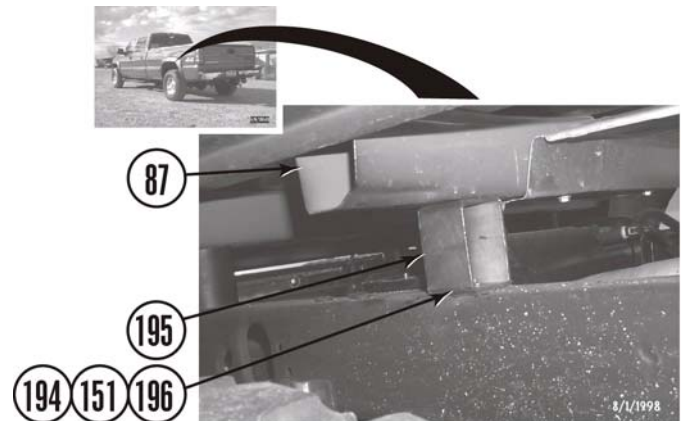

D. After installation is complete.

1. Install airbag fuse (5) in fuse panel (6). Install cover (4).

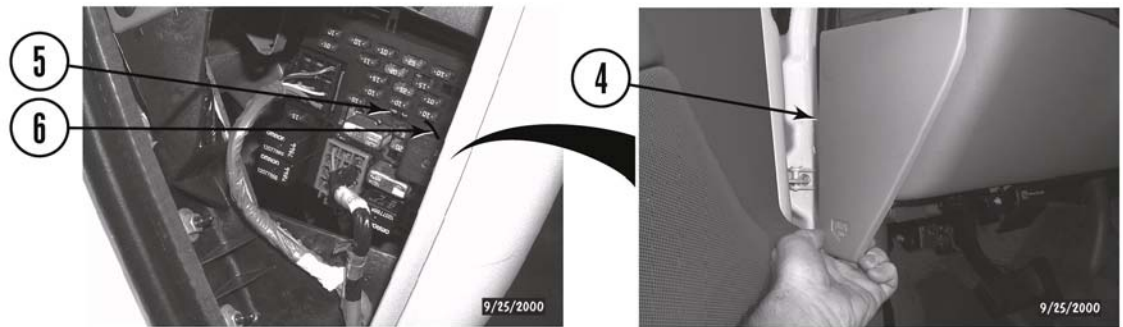

2. Connect both battery cables to the battery (3). Be sure to reconnect the positive cable (2) first, then the negative cable (1).
3. Install Gap Guards.
4. Stick *kit* warning sticker on the dash in plain sight of all vehicle occupants.
5. Double check the vehicle.

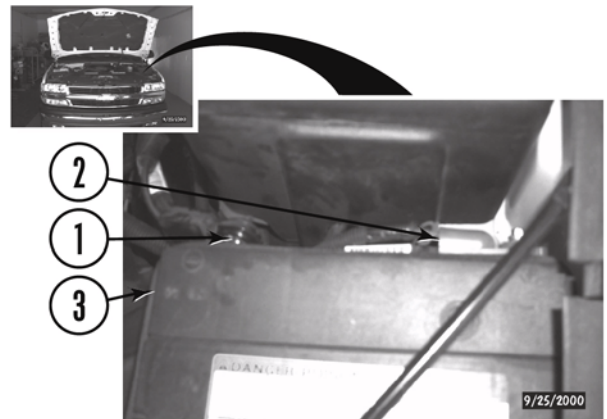

⚠CAUTION

Retorque all fasteners after 500 miles and after off road use. All body lift components should be visually inspected and fasteners retorqued during routine vehicle servicing.

- a. Check all mounting hardware to ensure it is properly tightened.
- b. Check all wires, hoses, cables, etc. to ensure they have been properly connected and there is ample slack. With the number of hoses on this vehicle, it is vital that this be checked thoroughly.
- c. Check vehicle electrical system.
- d. Adjust headlights.

Accessories

Available: Front & Rear Gap Guards

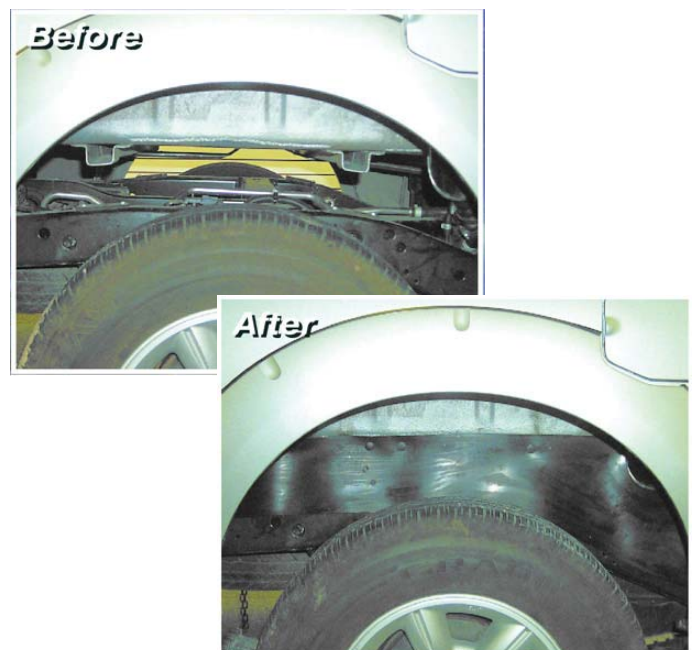

E. Kit Parts List

Qty. Description

Kit PA10092

- 2 **Block**, 2" height x 2" diameter (1/2" hole)
- 2 **Block**, 2" height x 2" diameter (5/8" hole)
- 14 **Block**, 2" height x 3" diameter
- 8 **Bolt**, 12mm-1.75 x 80mm
- 8 **Bolt**, 12mm-1.75 x 160mm
- 2 **Bolt**, 14mm-2.00 x 90mm
- 14 **Bolt**, 7/16" x 1 1/2"
- 2 **Bracket**, fan shroud lower ("L")
- 4 **Bracket**, fan shroud upper (flat, 2" hole-to-stud)
- 2 **Bracket**, front bumper inner ("C")
- 1 **Bracket**, ground strap (flat, 2" hole-to-hole)
- 4 **Crush block** (bed spacer, 2" square tube)
- 14 **Nut**, 7/16" nylock
- 2 **Nut**, 1/2" nylock
- 1 **Pin**, transfer case shift linkage extension (1/2" x 2")
- 44 **Washer**, 7/16" USS
- 2 **Washer**, 1/2" USS

Kit PA10093

- 2 **Block**, lift, 3" height x 2" diameter (1/2" hole)
- 14 **Block**, lift, 3" height x 3" diameter
- 8 **Bolt**, 12mm-1.75 x 100mm
- 8 **Bolt**, 12mm-1.75 x 180mm
- 2 **Bolt**, 14mm-2.00 x 110mm
- 14 **Bolt**, 7/16" x 1 1/2"
- 2 **Bracket**, fan shroud lower (flat, 1" hole-to-stud)
- 4 **Bracket**, fan shroud upper (flat, 3" hole-to-stud)
- 1 **Bracket**, front bumper inner, driver side ("L")
- 1 **Bracket**, front bumper inner, passenger side ("L")
- 2 **Bracket**, front bumper outer brace
- 1 **Bracket**, ground strap (flat, 3" hole-to-hole)
- 2 **Bracket**, "L" (if needed for fan shroud)
- 1 **Bracket**, rear bumper, middle
- 4 **Crush block** (bed spacer, 2" x 3" rectangular tube)
- 14 **Nut**, 7/16" nylock
- 6 **Nut**, 1/2" nylock
- 1 **Pin**, transfer case shift linkage extension (1/2" x 3")
- 40 **Washer**, 7/16" USS
- 6 **Washer**, 1/2" USS

Qty. Description

Kit PA10092 / PA10093

- 5 **Bolt**, 1/4" x 1"
- 2 **Bolt**, 1/4" x 3"
- 4 **Bolt**, 3/8" x 1 1/2"
- 1 **Bolt**, 3/8" x 1 3/4"
- 2 **Bracket**, cab safety strap extension (1 1/2" x 4 3/4")
- 1 **Bracket**, front bumper main, driver side
- 1 **Bracket**, front bumper main, passenger side
- 1 **Bracket**, rear bumper main, driver side
- 1 **Bracket**, rear bumper main, passenger side
- 2 **Bracket**, rear bumper side strap (studded)
- 2 **Bracket**, transmission cooler ("S", 2" hole-to-stud)
- 2 **Clip**, push
- 1 **Extension**, fuel filler
- 1 **Extension**, steering
- 2 **Hose clamp**, #20
- 2 **Hose clamp**, #36
- 1 **Label** (sticker), logo
- 1 **Label** (sticker), warning
- 1 **Loctite**, 6ml tube
- 2 **Nut**, 14mm nylock
- 11 **Nut**, 1/4" nylock
- 5 **Nut**, 3/8" nylock
- 4 **Screw**, 5/16" self-tapping
- 2 **Spacer tube**, transmission cooler (1/2" x 2")
- 1 **Tie**, zip
- 1 **Tube**, fuel filler extension
- 1 **Urethane**, radiator
- 2 **Washer**, 14mm
- 20 **Washer**, 1/4" SAE
- 6 **Washer**, 5/16" USS
- 2 **Washer**, 3/8" SAE
- 8 **Washer**, 3/8" USS
- 2 **Washer**, 1/2" thick
- 2 **Washer**, 1 1/2" x 2 1/2" rectangular
- 2 **Wire harness clamp**, rubber-clad