

Detroit Speed
RS Electric Headlight Door Kit
1968 & 69 Camaro
P/N: 122003 & 122004

Thank you for your purchase of Detroit Speed's RS Headlight Door Kit. This kit replaces the stock vacuum actuators on an RS headlamp equipped 1968 & 1969 Camaro. When installed, this kit will operate the headlight doors smoothly and reliably. The complicated, failure prone, and bulky vacuum accessories can all be eliminated. Vehicles with large cams with low vacuum signals will also benefit from this system since they are electronically controlled.

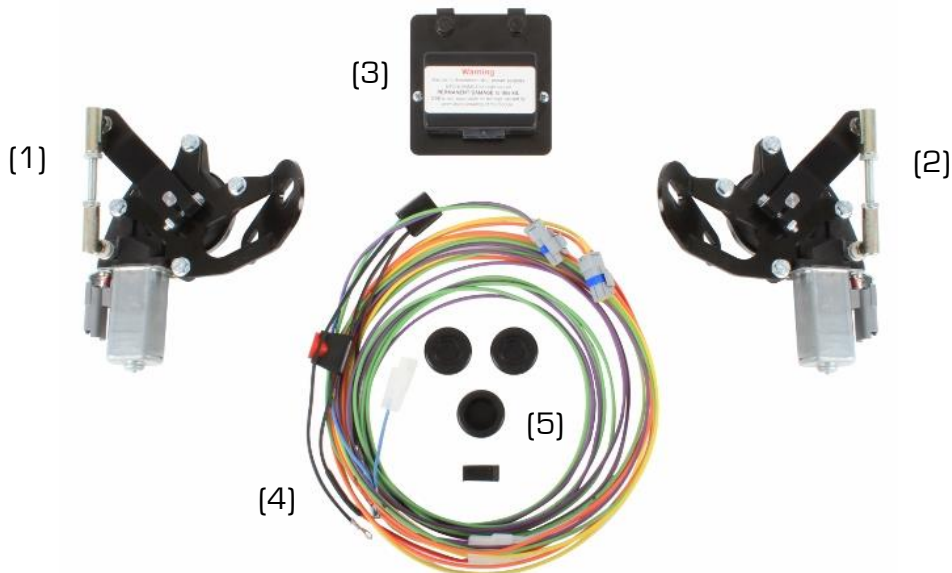

Figure 1 - P/N: 122003 - 1969 Camaro

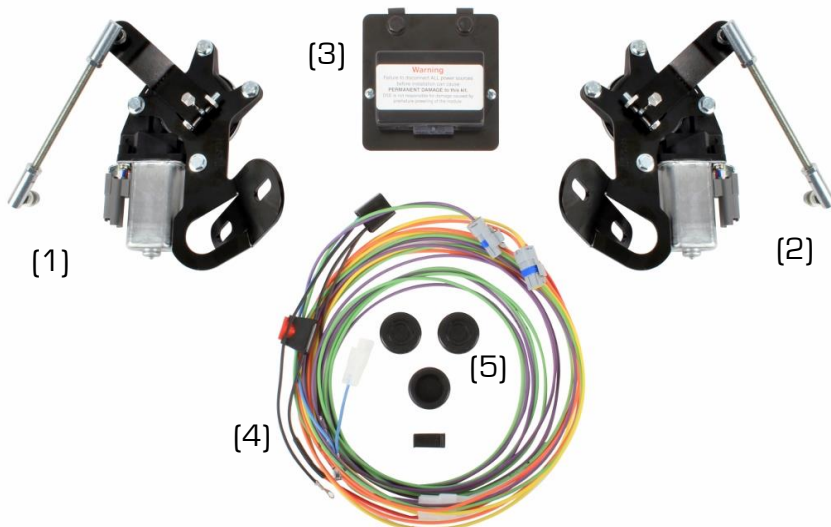

Figure 2 - P/N: 122004 - 1968 Camaro

Item	QTY	Description
1	1	LH Actuator w/ Bracket and Linkage
2	1	RH Actuator w/ Bracket and Linkage
3	1	Headlight Door Control Module w/ Bracket
4	1	Harness Assembly
5	3	Rubber Grommet
6	10	Nylon Wire Tie
7	1	Instructions/Inner Fender Template

WARNING: The RS electric headlight door kit will work best when the engine is running at idle. For everything to work the way it was designed, there must be over 12 volts through the electrical system to ensure it works correctly. For more troubleshooting information, please see page 18 of this instruction.

Many convenience features are integrated into this system. When the headlight switch is pulled to the “park” position, the park lamps illuminate. The headlights stay off and the headlight doors remain closed. When the switch is pulled to the “headlamps” position, the park lights stay on, the headlight doors open, and the headlamps illuminate. When the switch is pushed back to the “park” position, the headlamps turn off, but the headlamp doors remain open. This is useful to clean or service the headlamps since the doors will be open and the lenses cool. When switched to the “off” position, the park lights go out and the headlight doors close.

The module that is included with the RS Electric Headlight Door Kit has a unique integrated failsafe protection mode. The module is designed to protect itself from damage due to a short circuit in your wiring system. If a short exists, the module will click continuously. This means a short has been detected and the module has entered into its fail-safe mode. For the system to operate again, correction of the short circuit is required followed by resetting the module. To reset the module, remove the fuse from the main power wire for 10 seconds and then reinstall the fuse. If the clicking reoccurs, the short has not been repaired and needs further investigation.

The actuators are pressure sensitive to reduce the chance of personal injury or damage to the vehicle in the event that something is caught in the door during operation. If the door comes in contact with a foreign object, it will stop its operation. The lights will need to be cycled on and off to reset the mechanism. **NOTE:** The pitman arms on the actuators will not be able to be moved by hand as that could cause permanent damage to the actuators. The pitman arms are clocked in the correct position for installation at Detroit Speed and will cycle closed once power is introduced to the system.

Detroit Speed has gone to great lengths to provide you with the highest quality, best engineered product available with straightforward installation requiring minimal modification to your vehicle.

IMPORTANT: This kit is designed to work with properly installed and adjusted RS headlight doors. This system will not work correctly with doors that do not have the stops adjusted properly. The doors must open and close without binding or resistance. Because the system is pressure sensitive, binding or sticking RS door assemblies will cause the actuators to stop prematurely. Detroit Speed suggests lubricating all pivot points. Make sure that the main pivot shaft and the bellcrank are not overtightened.

The battery must be disconnected before starting the installation.

I. Mount the RS Headlight Module

1. Locate the brake pedal support bracket under the driver's side dash spanning from the brake pedal assembly to the steering column support attachment. Mockup the module and mounting plate. Locate the bolt holes on the support bracket with a marker or scribe (Figure 3). The module should be pointed towards the driver's side.

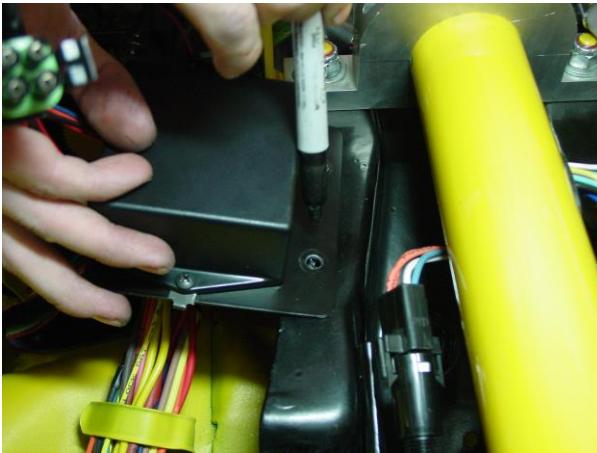

Figure 3a - Locating the Bolt Holes (69 Camaro)

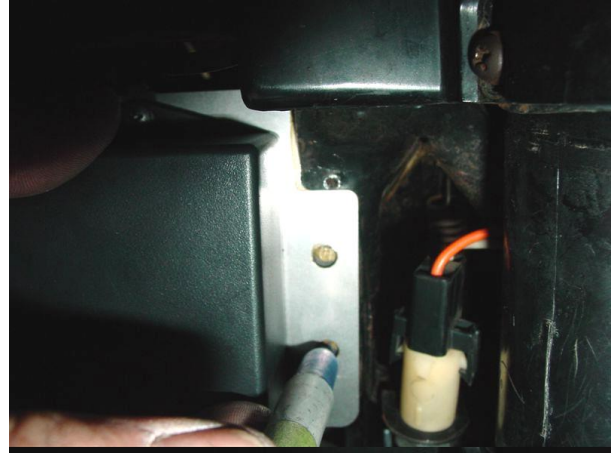

Figure 3b - 1968 Camaro

2. Using the marks from the previous step, drill two 5/16" diameter holes in the support bracket. Slide the two included U-nuts over the drilled holes. **NOTE:** For the 1968 Camaro, one U-nut is larger than the other. This is to compensate for the angle on the support bracket. Make sure the holes are drilled so that the U-nuts can be properly installed. Attach the module mounting plate to the support bracket using the two black oxide 1/4" diameter bolts and washers. The finished, mounted module assembly is shown in Figure 4.

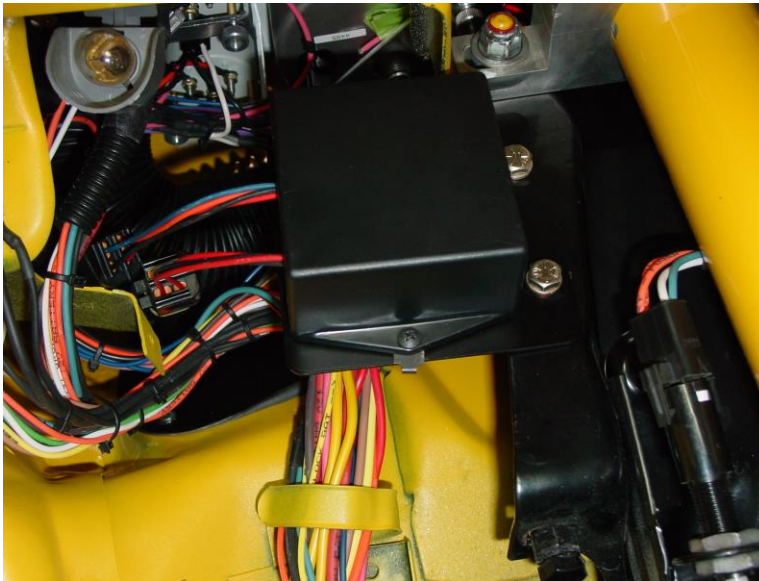

Figure 4a - Module Mounted in Place (69 Camaro)



Figure 4b - 1968 Camaro

II. Installing the Module Wiring

1. Remove the headlight switch from the dash. Skip to **Step 3** for 1969 Camaro. For 1968 Camaro, removing the switch can be simplified by removing the Astro Vent below the switch (Figure 5 on the next page).



Figure 5 - Removing the Astro Vent

2. The headlamp switch can then be removed from the dash through this opening (Figure 6).



Figure 6 - Accessing the Headlamp Switch

3. Remove the connector from the headlight switch. Locate and mark the blue wire (Figure 7). Remove the terminal from the connector using a terminal removal tool or a small flat blade screwdriver. The blue wire is the 12-volt headlamp feed.



Figure 7 - Locating the Blue Wire

- Slide the included black male connector over the blue wire terminal which was just removed from the headlight harness connector (Figure 8). Connect the stock blue wire to the white female connector (blue wire) on the harness assembly (Figure 9).

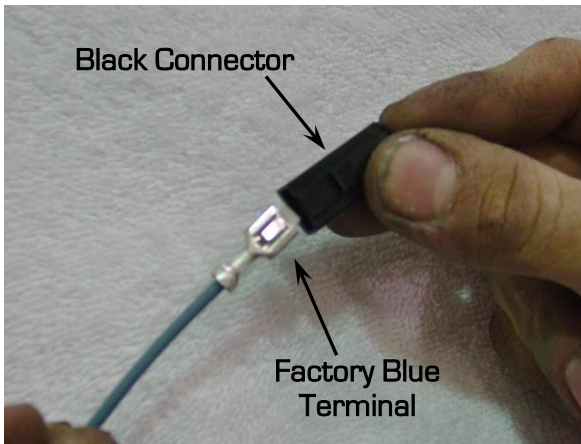

Figure 8 - Install Black Connector

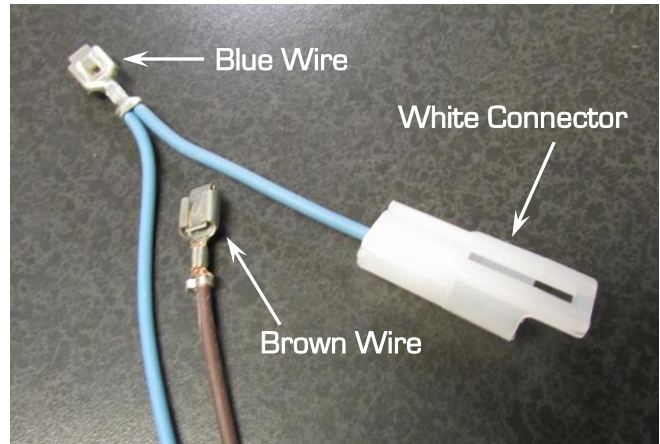

Figure 9 - Harness Assembly

- Now, locate the blue and brown wires on the supplied harness assembly. Slide the blue wire/female terminal (Figure 8 above) into the cavity in the headlight switch connector where you removed the stock blue wire. Slide the female terminal on the brown wire (Figure 9 above) into the empty cavity shown in the picture (Figure 10).

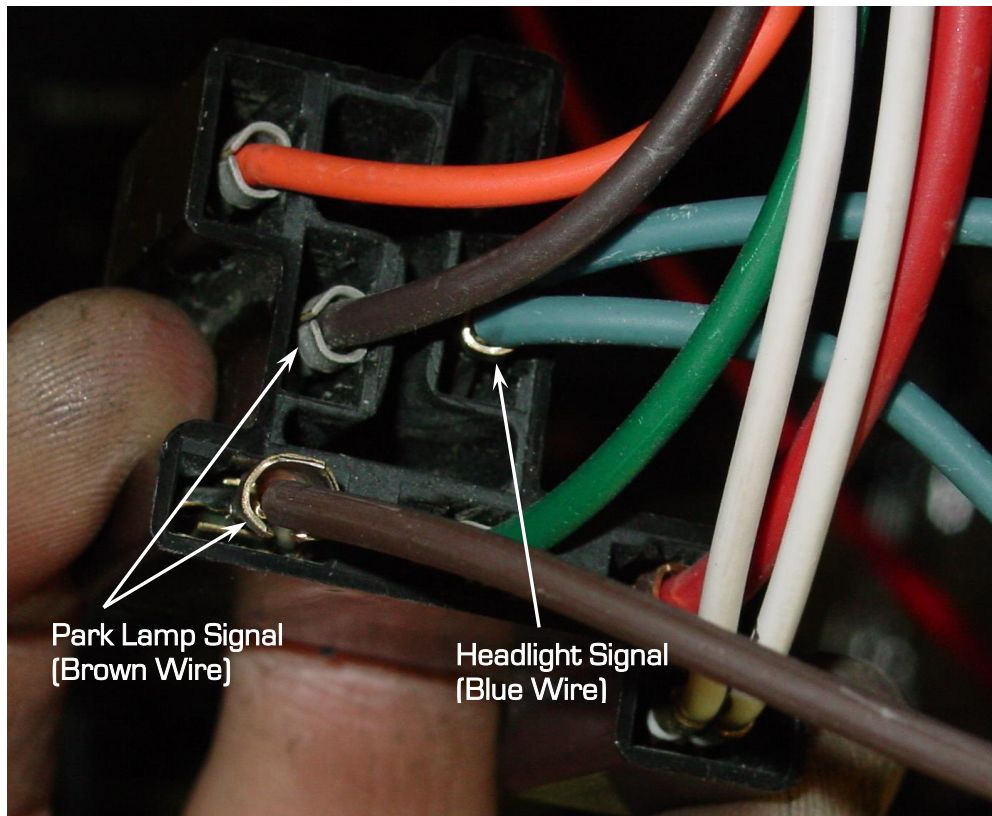
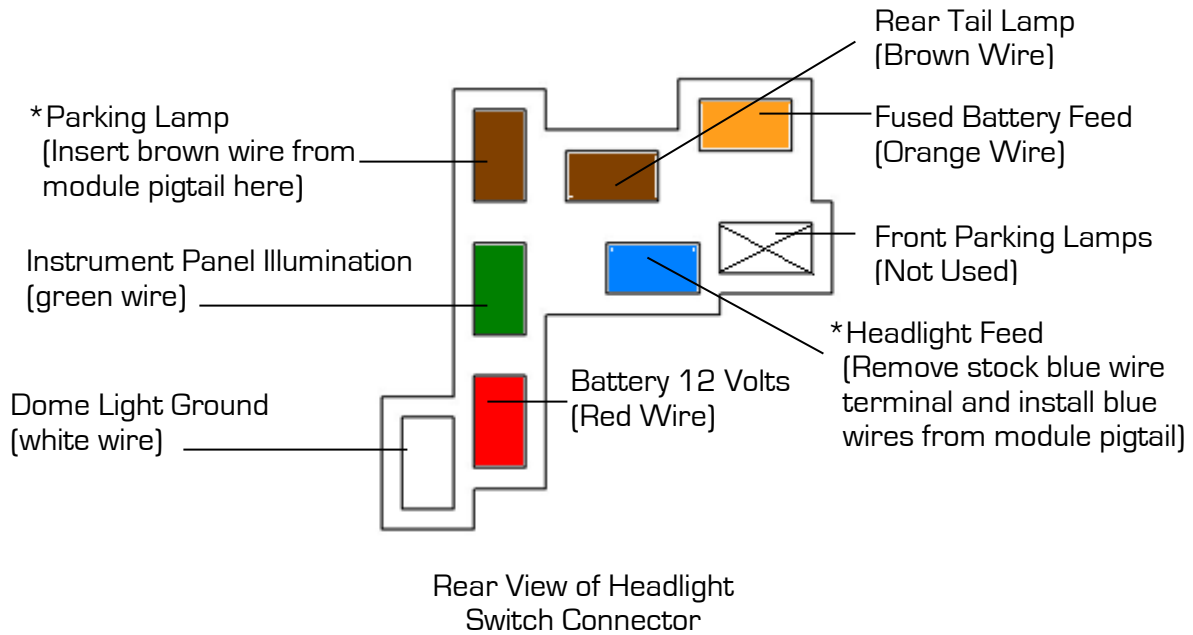

Figure 10 - Locating the Brown & Blue Wires

- If you are using an aftermarket wiring harness, this terminal may be filled. In this event, the brown wire must be spliced into the park lamp signal wire. Connect the black ground wire to the ground stud under the dash near the parking brake. **NOTE: DO NOT** attach the red positive lead to a constant 12V power source at this time. This will be done in a later step.



NOTE: The two leads for the parking lamp (numbered 3 and 5) will need to be bridged together in order for this kit to work correctly (Figure 11). If your headlight switch does not have a bridge, you will need to jump the two leads together.

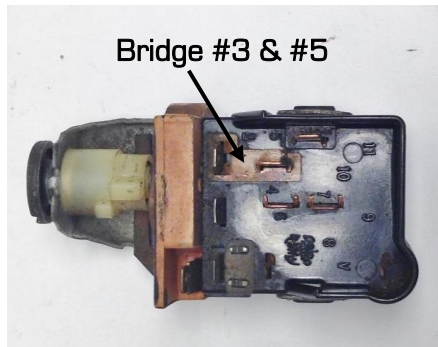

Figure 11 - Headlight Switch

III. Install the Actuator Harness

1. Drill a 1-1/8" diameter hole near the firewall bulkhead using a Uni-bit or drill bit to pass the headlight motor connectors through the firewall. Use the included firewall grommet to protect the wiring (Figure 12).

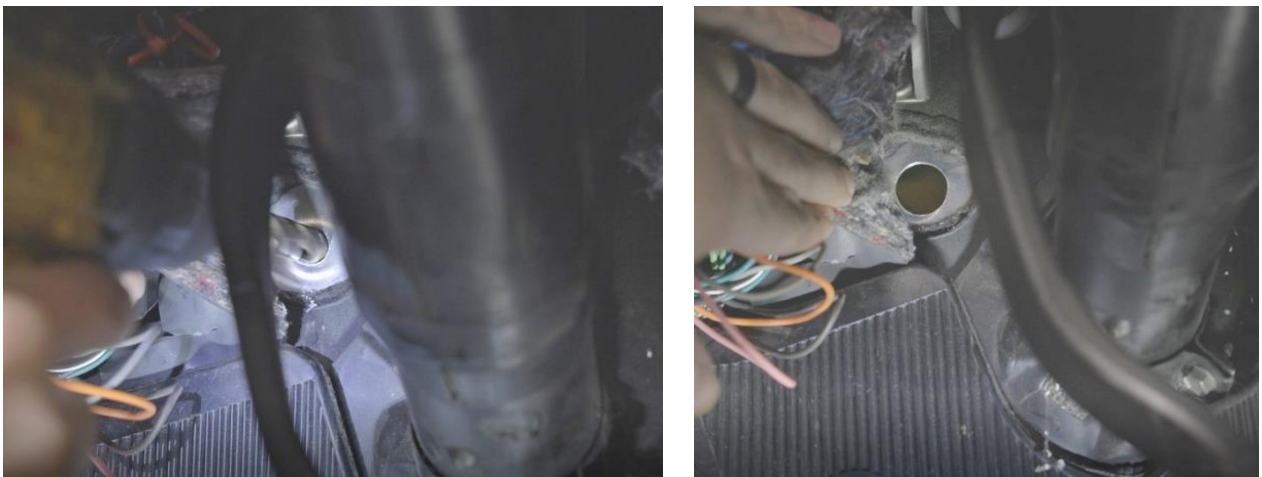

Figure 12 - Drill Hole for Harness

2. Route the wires along the inner fender well along the stock headlight harness toward the front of the vehicle. You can either use an existing hole to pass the harness leads through (Figure 13) or drill a 1-1/8" diameter hole behind each headlight bucket. We suggest drilling the hole adjacent to the turn signal wire grommet.



Figure 13 - Route Harness

3. Insert the supplied rubber grommets and feed the two wires through toward the actuator. The yellow and orange wires should pass through the driver's side inner wheelhouse. Route the green and purple wires along the factory harness underneath the core support to the passenger side inner wheelhouse (Figure 14). Pass the green and purple wires through the grommet. Secure the harness with the supplied nylon ties.



Figure 14 - Route Passenger Side Harness

IV. Install Actuators and Linkage

NOTE: A template has been attached on page 19 for the 1969 Camaro and page 21 for the 1968 Camaro of the instructions. They will assist you in locating where to cut holes in your stock inner fenders to install the RS headlight assemblies in vehicles that were not originally RS headlight equipped. Some aftermarket inner fenders may also need this template to locate the holes for the RS headlight assemblies.

1. Remove the battery and battery tray from the Camaro.
2. Under the vehicle, if the headlight door vacuum actuator system is still installed, remove it from the vehicle. The vacuum tanks, actuators, hoses and valves will not be needed. **NOTE: If there is an over-center spring installed on the bell crank assembly, it must be removed.** It is located behind the headlight bucket. Right angle pliers and a screwdriver will be helpful to remove the spring. Be sure to wear proper eye protection. If the spring cannot be removed, the headlight bucket assembly will have to be removed from the Camaro.

3. If you do not need to locate holes in your inner fenders, skip to **Step 9**.
4. Remove the front grill and both headlight bucket assemblies from the Camaro.
5. Cut the template from the instruction sheet. The template can be used on both sides by flipping it over. After cutting out the template, align it to the front edge of the inner fender and the existing holes (Figure 15).



Figure 15 – 1968 Camaro Template

6. Mark the new holes on the inner fender and drill pilot holes from underneath the vehicle. **NOTE:** It may help to remove the fog lights. Drill out the appropriate hole sizes according to the template directions (Figure 16). File the holes as needed.

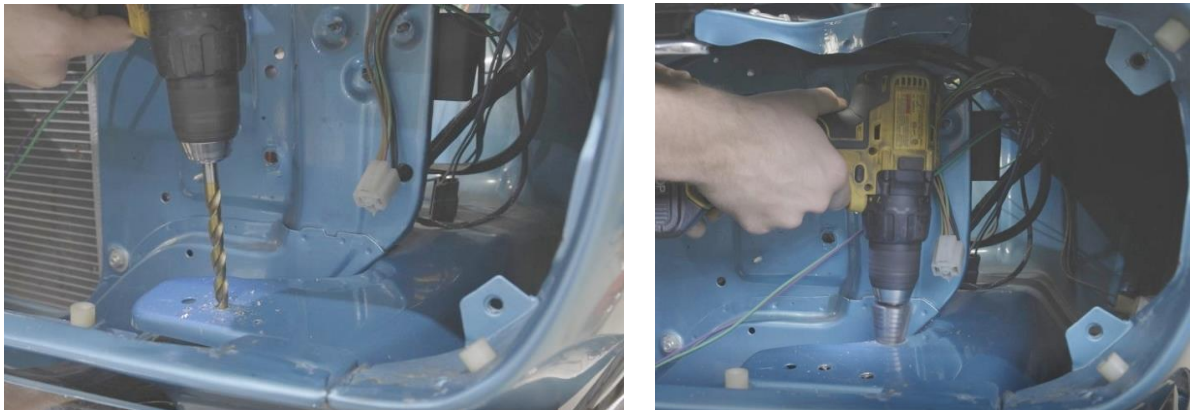

Figure 16 – Drill Template Holes

7. Install the bell crank support bracket to the inner fender from underneath the Camaro. Use the two 3/8" existing holes or the holes that were drilled in the previous step (Figure 17). The large hole in the support bracket should be centered underneath the bell crank hole in the inner fender. Tighten the bolts.



Figure 17 – Install Bell Crank Support Bracket

- Place the bell crank through the large existing hole in the inner fender or the large hole that was drilled in Step 5 (Fig. 18). The stud will sit in the large hole in the support bracket.



Figure 18 - Position Bell Crank

- There are several fasteners to locate the bell crank into the bell crank support bracket. Between the bell crank and the bracket, you will place a steel washer over the stud on the bell crank followed by a flanged nylon washer so that it locates in the hole of the support bracket. On the bottom side of the bell crank bracket, place another flanged nylon washer over the bell crank stud and into the hole in the bell crank bracket. Then, place the wave washer onto the nylon washer followed by a steel washer and then the hex nut. Loosely tighten the hex nut (Figure 19).



Figure 19 - Install Bell Crank Fasteners

- Place the headlight door back into the Camaro if removed. Re-install the hardware to hold the headlight door assembly in the Camaro (Figure 20). Re-connect the factory headlight connector back into the headlight.



Figure 20 - Re-install Headlight Door Assembly

11. Attach the bell crank arm to the headlight door if removed and tighten (Figure 21). Move the headlight door by hand to make sure it moves smooth and easy.



Figure 21 - Attach Bell Crank

12. Locate the two fasteners that attach the inner wheelhouse to the core support underneath the front fender area. Using a 1/2" socket and remove these two fasteners (Figure 22).



Figure 22 - Remove Core Support Fasteners

13. Identify the left- and right-hand actuators below (Figure 23).



1968 Camaro LH (Driver's Side)

1968 Camaro RH (Passenger's Side)



1969 Camaro LH (Driver's Side) 1969 Camaro RH (Passenger's Side)
Figure 23 – Actuators

14. Position the actuator and bracket assembly underneath the Camaro. The actuator should point forward, and the pitman arm should be on the bottom side of the bracket (Figure 24). The holes are slotted so that the actuator assembly can be aligned with the bell crank of the RS headlight assembly.



Figure 24 – Position Actuator & Bracket Assembly

15. Reinstall the two fasteners using a 1/2" wrench and socket to attach the actuator to the Camaro (Figure 25). Position the actuator/bracket so that the pitman arm can pass underneath the splash guard bracket without contact. If you plan on using the splash guard, you will need to trim it as necessary to clear the pitman arm.



Figure 25 – Install Actuator

16. Insert one of the two supplied nylon bushings onto the actuator linkage (Figure 26). Install the linkage to connect the actuator to the bell crank. **NOTE: Do not attempt to power up the headlight motors without the pitman arm linkage attached to the bell crank.** The headlight motors are shipped with the pitman arm in the “parked” position. If the headlight motors are powered and moved from the original “parked” position without the linkage attached, it may result in the pitman arm crashing into the bell crank.



Figure 26 – Install Nylon Bushing

17. Install with the supplied washers and locknut using a 3/8” and 7/16” wrench (Figure 27). If the linkage does not reach the bell crank, reposition the headlight door until they can be assembled. **NOTE: Do not attempt to move the pitman arms on the actuators by hand to attach the linkage as this could cause permanent damage to the actuators.**

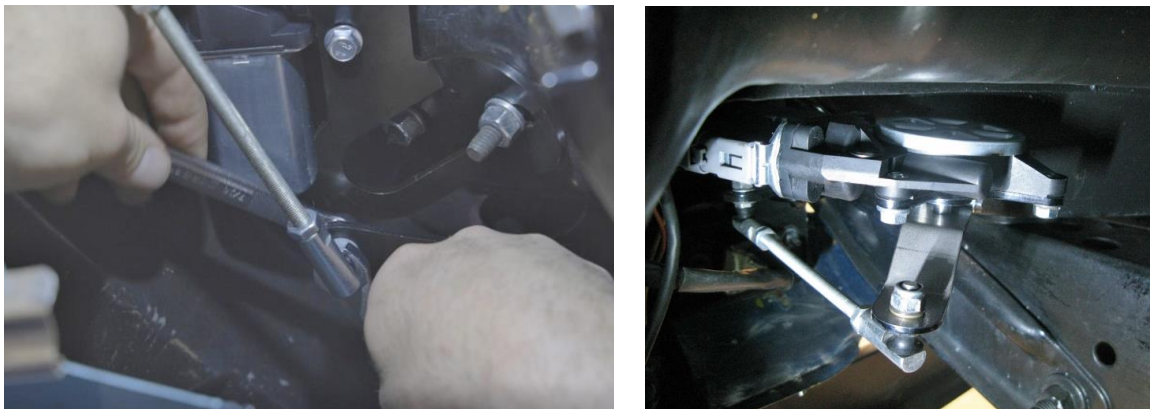

Figure 27 – Connect Actuator Linkage

18. Connect the harness to the actuators and make sure the wires are routed away from moving parts or sharp edges (Figure 28). Use the supplied nylon wire ties to secure the harness. Install the other actuator assembly into the other side of the vehicle.

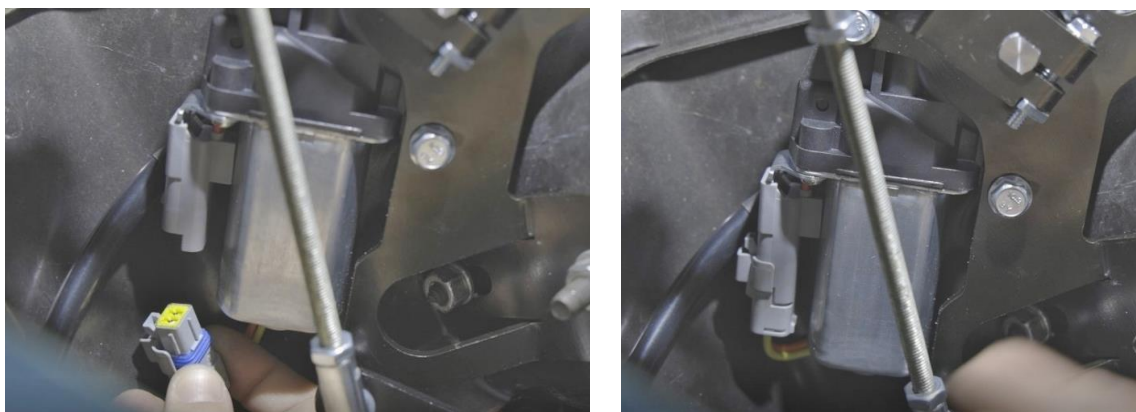

Figure 28 – Connect Harness to Actuator

19.Repeat this process for the opposite side of the Camaro.

20.Re-install the battery and tray however do not hook up the cables yet (Figure 28).

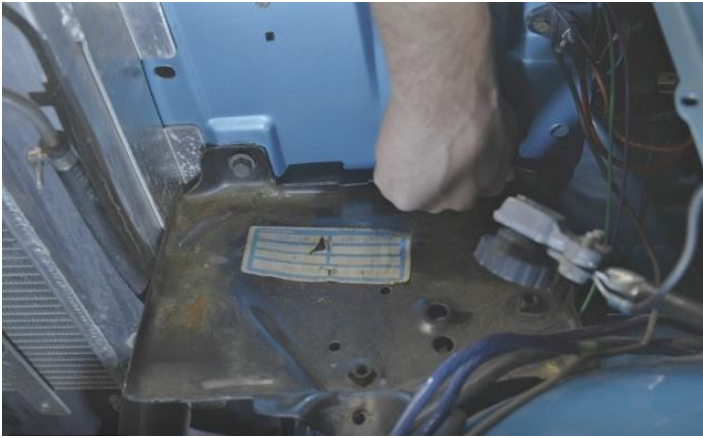

Figure 28 – Re-install Battery & Tray

V. Powering the System

1. Under the dash, strip the red power wire on the module harness. Attach and crimp a wire terminal onto the end of the red wire. Place a wire connector over the wire terminal and make sure it locks in place (Figure 29).

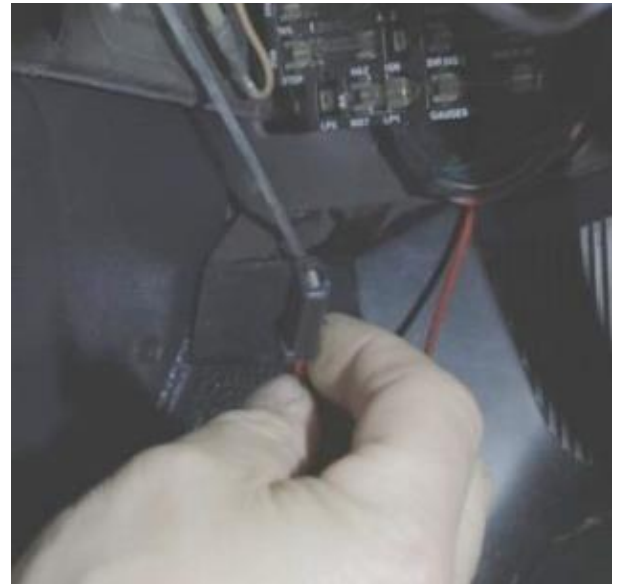

Figure 29 – Crimp Terminal to Red Wire

2. Attach a 12V constant power source to the module by installing the red wire from the new harness into an open slot on the fuse block labeled “battery” (Figure 30 on the next page). Make sure the 10-amp fuse is installed in between the power source and the module.



Figure 30 - Attach 12V Constant Power Source

3. Connect the black wire with the ring terminal on the new headlight harness to a suitable ground (Figure 31). Make sure to remove any paint or corrosion to ensure that a good ground connection is made.



Figure 31 - Connect Ground Wire

4. Connect the new headlight harness to the module. The clear connector on the harness will plug into the black connector on the module. (Figure 32 on the next page).

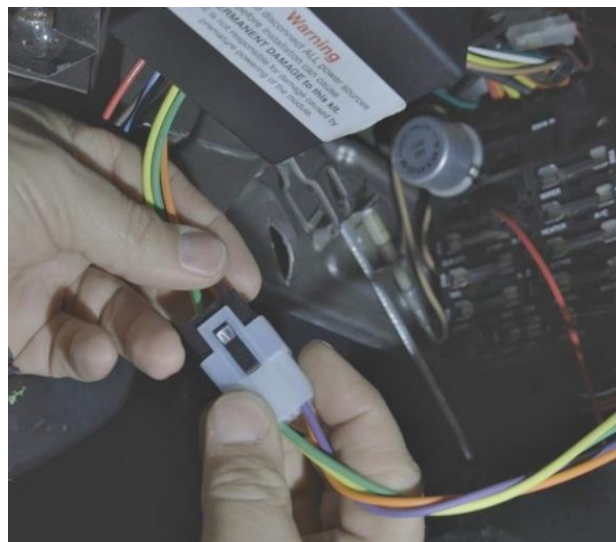

Figure 32 - Connect Harness to Module

5. The black connector on the harness will plug into the clear connector on the module (Figure 33). Verify this by checking that the wire colors on the harness match the wire colors on the module pigtails.

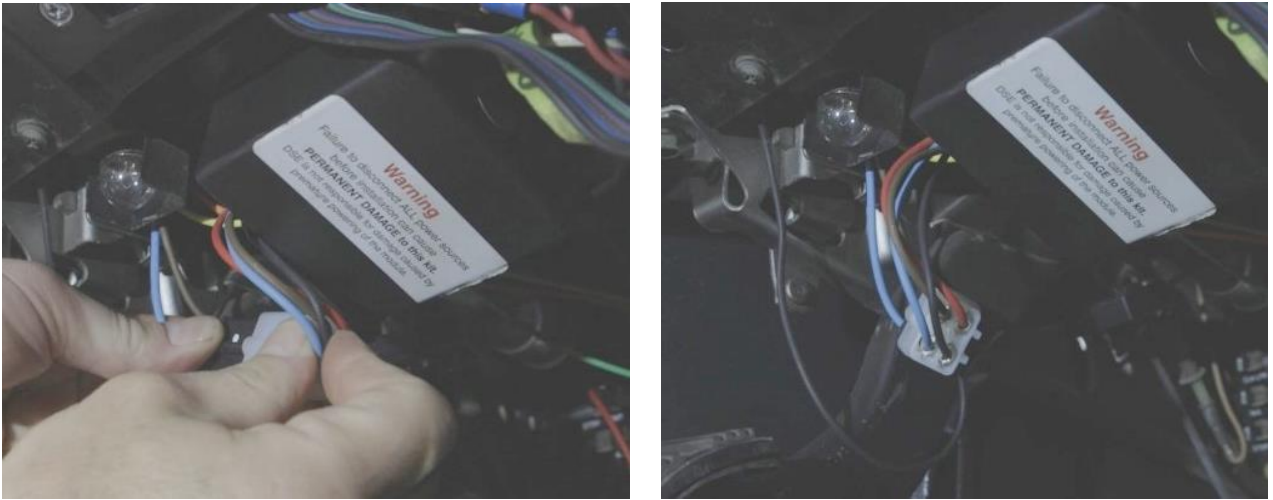

Figure 33 - Connect Module to Harness

6. Before powering the system, double-check all wiring connections for continuity using a multi-meter. Incorrect wiring can cause serious damage to the system.
7. Reconnect the battery (Figure 34). The system will cycle at this point and the doors should be in the closed position.



Figure 34 - Reconnect Battery

8. Once the system has cycled, check the operation of the system by turning the headlamps on and off. Re-install the headlight knob in the headlight switch to test the system. **NOTE:** You do not have to re-install the headlight switch in the dash to test the system.
9. Adjust the tightness of the bell crank fastener as needed (Figure 35 on the next page). If the system is not operating, check all your wiring connections again and refer to the troubleshooting guide at the end of these instructions. **NOTE:** If you are still having problems, one solution is to bypass the fuse block and run the power and ground wires directly to the battery.



Figure 35 – Adjust Bell Crank Fastener

VI. Re-assembly Camaro

1. Re-install the grill back into the Camaro (Figure 36).



Figure 36 – Re-install Grill

2. Re-install the headlight switch back into the dash. Make sure to align the anti-rotation tab on the switch into the slot located at 9 o'clock on the dash (Figure 37).



Figure 37 – Re-install Headlight Switch

3. Position the headlight switch bezel to the dash and tighten the headlight nut into the switch to hold the bezel and switch in place (Figure 38).



Figure 38 – Re-install Headlight Bexel and Switch Nut

4. Re-install the headlight knob back into the switch. Make sure the knob locks in place in the switch (Figure 39).



Figure 39 – Re-install Headlight Knob

5. Re-install the Astro vent that was removed (Figure 40).



Figure 40 – Re-install Astro vent

If you have any questions before or during the installation of this product, please contact Detroit Speed at sales@detroitsspeed.com or 704.662.3272

Legal Disclaimer: *Detroit Speed is not liable for personal, property, legal, or financial damages from the use or misuse of any product we sell. The purchaser is solely responsible for the safety and performance of these products. No warranty is expressed or implied.*

RS Headlight Troubleshooting

After all connections are made, connect the battery. The doors should go through a "power up" cycle. During this cycle, the doors will close. Anytime the current source to the module is disconnected and reconnected, the doors will go through the "power up" cycle. The module features a failsafe protection to protect the module from being shorted out. If a short exists, the module will beep and is followed by a series of clicks. This means a short has been detected and the module has entered into its fail safe mode. For the system to operate again, correction of the short circuit is required followed by resetting the module. To reset the module, remove the fuse from the main power wire for 10 seconds and then reinstall the fuse. If the clicking reoccurs, the short has not been repaired and needs further investigation. The following chart shows the expected voltages at the module input during typical operation. Use this to troubleshoot the wiring installation and headlight switch operation.

Headlight Switch Position	Wire Color				Door Operation	Light Operation
	Red	Black	Brown	Blue		
Off	+ 12 V	Ground (- 12V)	0 V	0 V	None	None
Park	+ 12 V	Ground (- 12V)	12 V	0 V	None	Park
Headlight	+ 12 V	Ground (- 12V)	12 V	12 V	Door Opens	Park/Headlights
Park (after headlights on)	+ 12 V	Ground (- 12V)	12V	0 V	None (Door remains open w/headlights off)	Park
Off	+ 12 V	Ground (- 12V)	0 V	0 V	Door Closes	None

Condition	Cause
Module clicks continuously.	The module has entered into its failsafe mode. The module enters into this mode when it detects a short in the system. To correct, determine and repair the short that exists in the system. To return the module to its normal function, remove the 10 amp fuse for 10 seconds and reinstall the fuse. The system should go through its "power up" cycle. If it does not or the clicking continues, a short still exists in the vehicles electrical system and requires further investigation.
Doors only open or close partially.	Most issues with door operation are due to headlight door assemblies that have too much resistance, binding, or are out of adjustment. To check for correct operation of the module and actuators, disconnect the linkages from the pitman arms. With nothing attached to the motor pitman arm, have another person cycle the switch from off, to park, to headlight, and then back to off. The actuators should turn approximately one complete revolution in one direction, stop, and then turn one revolution in the opposite direction. If the actuators operate as described, intermittent problems are most likely due to doors that have too much resistance opening and/or closing.
One door opens faster/slower than the other.	One door has more/less resistance than the other. Lubricate pivot points and adjust the tension of fasteners at pivots points.
Doors do not operate at all.	Make sure the battery voltage is over 11.5 V. A low battery condition can result in inoperable doors. Check all connections. Make sure fuse is not blown and doors are not binding.
One or both doors close when the headlight switch is turned on. Door(s) open when the headlight switch is turned off.	On the driver's side, make sure the yellow wire is inserted into cavity "2" and the orange wire into cavity "1" of the connector body. The purple wire should be inserted into cavity "2" and the green wire into cavity "1" of the connector body for the passenger side. If the wires are terminated properly and the problem still exists, reversing the wires on the offending actuator(s) will solve the problem.
Doors do not go through "power up" cycle.	Check voltages at red, black, blue, and brown wires as described in above chart. If voltages are consistent with the chart, try disconnecting and reconnecting the red wire. If the doors do not operate or do not attempt to operate at this point, double check that the actuator harness is plugged into the module and the actuators. Check continuity between the actuator wires at the module pigtail and at the actuator connector.

Module Connector Pin-out (back of connector)

Red Wire	Constant 12V Battery Voltage
Black Wire	Ground
Brown Wire	Park Lamp Feed
Blue Wire	Headlight Feed
Orange Wire	LH Actuator +
Yellow Wire	LH Actuator -
Green Wire	RH Actuator +
Purple Wire	RH Actuator -

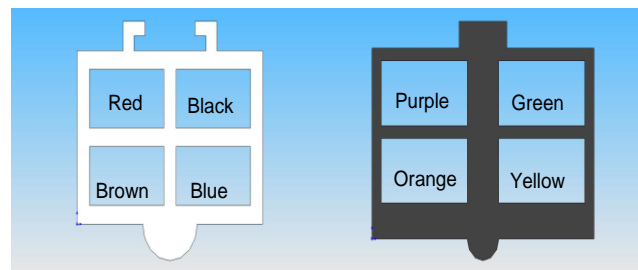

*looking from back side of connector

*If none of these suggestions solve your particular issue, please call Detroit Speed at (704) 662-3272.

POSITION THE TEMPLATE WITH THIS SIDE TOWARDS THE FRONT OF CAR ON THE UNDERSIDE OF THE INNER FENDER

Cut the inner fender in these locations

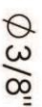
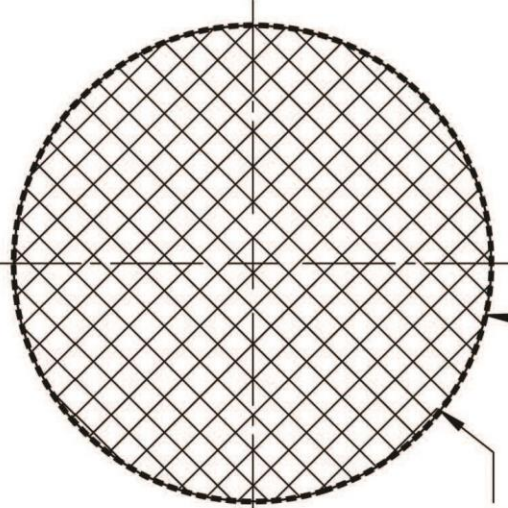

Cut this Template from the cross-hatched area.

5

4

3

2

1

UNLESS OTHERWISE SPECIFIED:

DIMENSIONS ARE IN INCHES
 TOLERANCES:
 FRACTIONAL: ± 1/64
 ANGULAR: MACH ± .5°, BEND ± .5°
 TWO PLACE DECIMAL: ± .01
 THREE PLACE DECIMAL: ± .005

INTERPRET GEOMETRIC TOLERANCING PER: ASME Y14.5M-1994

MATERIAL

FINISH

SCALE: 1:1



PROPRIETARY AND CONFIDENTIAL

THE INFORMATION CONTAINED IN THIS DRAWING IS THE SOLE PROPERTY OF DETROIT SPEED & ENGINEERING. ANY REPRODUCTION IN PART OR AS A WHOLE WITHOUT THE WRITTEN PERMISSION OF DETROIT SPEED & ENGINEERING IS PROHIBITED.

DRAWN BY

APPR. BY

FSH DATE 03/21/07

TITLE

RS Inner Fender Template

APPLICATION(S)

1969 Camaro RS Conversion

SIZE

DWG. NO.

A 9912116 DSE-F501-75

REV

PRINTED ON 4/4/2007

SHEET 1 OF 1

LEAVE THIS PAGE BLANK

Cut this template from the cross-hatched area.

POSITION THE TEMPLATE WITH THIS SIDE TOWARDS THE FRONT OF THE VEHICLE ON THE UNDERSIDE OF THE INNER FENDER

CUT THE INNER FENDER IN THESE LOCATIONS

**1968 CAMARO RS CONVERSION
INNER FENDER TEMPLATE**

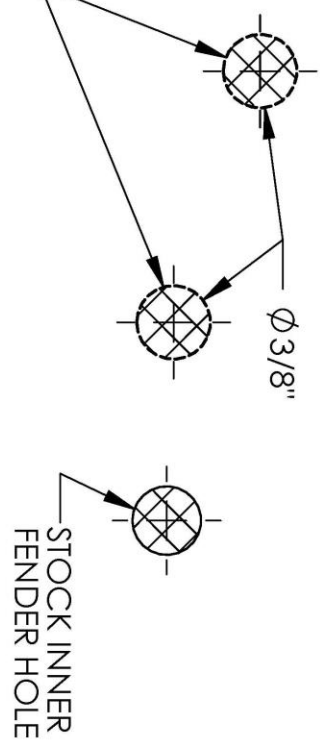

$\phi 1 1/2''$

$\phi 3/8''$

STOCK INNER FENDER HOLE

UNLESS OTHERWISE SPECIFIED:
DIMENSIONS ARE IN INCHES
TOLERANCES:
FRACTIONAL: $\pm 1/64$
ANGULAR: MACH $\pm .5^\circ$ BEND $\pm 1^\circ$
TWO PLACE DECIMAL: $\pm .01$
THREE PLACE DECIMAL: $\pm .005$

INTERPRET GEOMETRIC TOLERANCING PER: ASME Y14.5M-1994

PROPRIETARY AND CONFIDENTIAL
THE INFORMATION CONTAINED IN THIS DRAWING IS THE SOLE PROPERTY OF DETROIT SPEED & ENGINEERING. NO PART OF THIS DRAWING IS TO BE REPRODUCED OR TRANSMITTED IN ANY FORM OR BY ANY MEANS, WITHOUT THE WRITTEN PERMISSION OF DETROIT SPEED & ENGINEERING. IS PROHIBITED.



TITLE
RS Inner Fender Template

APPLICATION(S)
1968 Camaro RS Conversion

MATERIAL
FINISH
SCALE: 1:1

DRAWN BY: CSM DATE: 12/15/08
APPR BY: DATE:

DO NOT SCALE DRAWING

SIZE DWG. NO. **A** 9912128 **REV** P-00
PRINTED ON 3/17/2009 SHEET 1 OF 1

5 4 3 2 1