

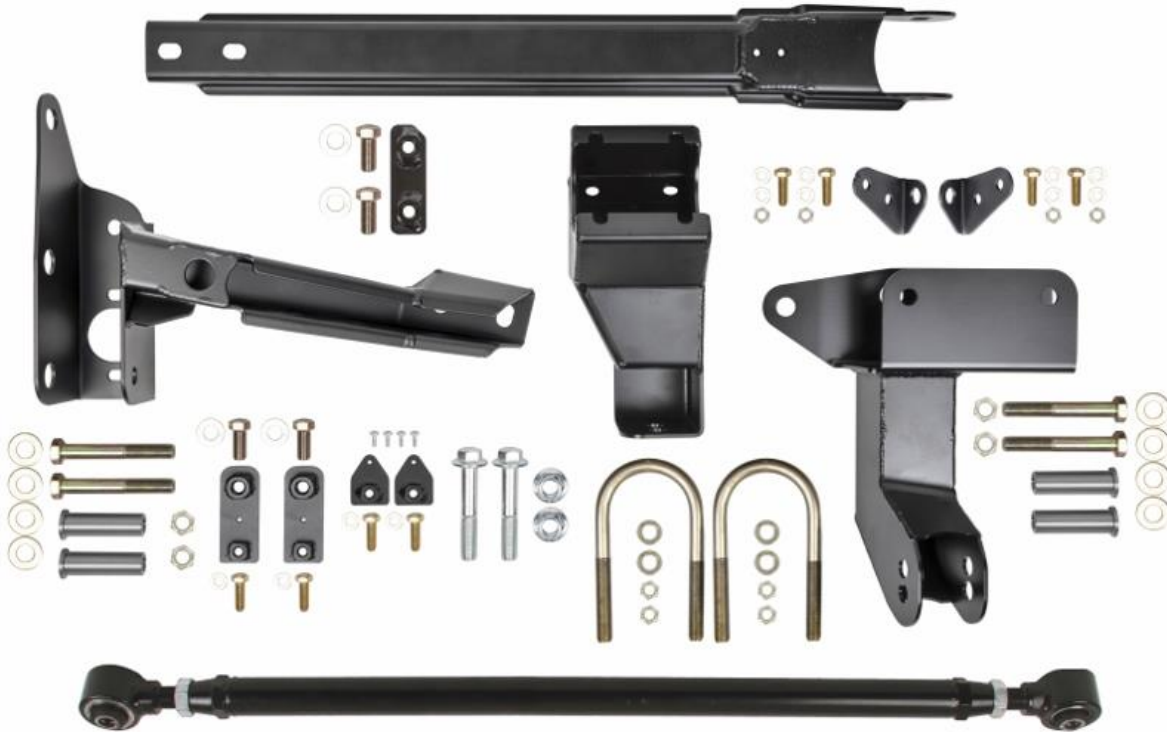

**Detroit Speed**  
**Adjustable Track Bar Kit**  
 1979-93 Mustang & 1979-86 Capri  
 P/N: 042111DS

The Detroit Speed Adjustable Track Bar kit is a direct bolt-on package for the Fox body platform. It features Detroit Speed cross-axis pivot bushings, and the bar can be adjusted without un-bolting it from the vehicle. The track bar kit comes with two mounting hole locations to adjust to your vehicles' ride height. The body side and axle brackets come powdercoated black with hardware so it's ready to install.



Item	Description	Quantity
1	Track Bar Assembly	1
2	Track Bar Frame Rail Brace Assembly - RH	1
3	Track Bar Brace Assembly	1
4	Axle Side Track Bar Mount Assembly	1
5	Body Side Track Bar Mount Assembly - LH	1
6	Track Bar Shock Tower Reinforcement Bracket - LH & RH	2
7	Track Bar Installation Kit	1
8	Track Bar Hardware Kit	1
9	Instructions	1

**NOTE:** There is an installation video available through the Detroit Speed website under install video shown here: [detroitsspeed.com/blog/post/detroit\\_speed\\_1979-93\\_mustang\\_install\\_-\\_adjustable\\_track\\_bar\\_kit](http://detroitsspeed.com/blog/post/detroit_speed_1979-93_mustang_install_-_adjustable_track_bar_kit).

**NOTE:** If your exhaust goes around the rear axle, it will need to be modified before it can go back into the vehicle to fit around the track bar kit.

***IMPORTANT:***

All work should be performed by a qualified technician. Please read the entire set of instructions and fully understand all of the steps involved before beginning the project. Always make sure to wear the appropriate safety equipment for the job and properly support the vehicle. If you have any questions before, during, or after the installation, feel free to contact Detroit Speed by phone at (704) 662-3272 or by email at [tech@detroitsspeed.com](mailto:tech@detroitsspeed.com).

**Recommended Tools:**

- Properly rated floor jack, support stands, and wheel chocks
- Combination wrench set
- Torque Wrench: 0-75 ft-lbs. range
- Ratcheting socket wrench and socket sets
- Cut off Wheel and/or Air Saw
- Drill and Drill Bit Set
- 3/4" Hole Saw
- Transfer Punch Set
- Safety Glasses
- Die Grinder

Installation/Hardware Checklist – DSE Adjustable Track Bar Kit			
Part Number	Description	Quantity	Check
<b>200068</b>	<b>Track Bar Installation Kit</b>	<b>1</b>	
9304423	Frame rail Weld Nut Doubler Plate, Double	2	
9304424	Frame rail Weld Nut Doubler Plate, Single	2	
9304425	Track Bar Brace Weld Nut Doubler Plate Assembly	1	
9304252	7/16"-20 x 2-3/4" x 4-1/2" L U-Bolts	2	
99040669	Frame rail Crush Sleeve	4	
<b>200069</b>	<b>Track Bar Hardware Kit</b>	<b>1</b>	
950133FS	1/4" x 1" L Self Drill Point Screw	2	
950109FS	8-32 x 1/2" L Flat Head Screw	4	
980016FS	5/16" AN Flat Washer	12	
980111FS	5/16"-18 x 1" L Hex Head Bolt	4	
950047FS	5/16"-18 x 3/4" L Hex Head Bolt	4	
960033FS	5/16"-18 Nylock Nut	4	
970037FS	1/2" SAE Flat Washer	4	
980037FS	1/2"-20 x 3-3/4" L Hex Head Bolt	4	
960004FS	1/2"-20 Nylock Nut	4	
960050FS	7/16"-20 Nylock Nut	4	
970042FS	7/16" SAE Flat Washer	12	
980051FS	7/16"-20 x 1" L Hex Head Bolt	4	
950131FS	M12-1.75 x 30 Button Head Screw	2	
970026FS	M12 Flat Washer	2	
980103FS	M14-2.0 x 80 Flanged Hex Head Bolt	2	
960098FS	M14-2.0 Flanged Lock Hex Nut	2	

Fastener Torque Specifications	
Application	Torque (ft-lbs)
Track Bar Bolts	120
Track Bar Jam Nuts	50
7/16"-20 Doubler Plate Bolts	35
5/16"-18 Doubler Plate Bolts	25
1/2"-20 Frame Rail Bolts	70
7/16"-20 U-Bolts	45

**Installation:**

1. Confirm that all components and hardware has been included in the kit using the parts list and picture for reference on page 1 and 2.
2. On a smooth level surface, block both sides of the rear tires. Loosen the rear lug nuts and jack up the front and then the rear of the vehicle. Support the car in the front and the rear by securely placing jack stands under the frame so the car is sitting level. Remove the rear wheels and tires.
3. Place two jack stands securely under the rear axle tubes. If your vehicle is equipped with a factory or aftermarket sway bar, remove the two sway bar bolts located in the lower trailing link or remove the sway bar endlinks on both sides of the vehicle.
4. Remove the shocks from the rear axle by removing the bolts holding the lower shock in place on the rear axle brackets. Using a floor jack, raise the rear axle off the jack stands. Remove the jack stands and lower the rear axle so it is in full droop (Figure 1). If you have a 1984-93 vehicle, remove the Quad Shocks from the vehicle.



**Figure 1 – Remove Lower Shock Bolts**

5. Separate the rear exhaust system from the front exhaust. Remove the exhaust hangers from the isolators (Figure 2). Remove the rear exhaust from the vehicle.



**Figure 2 – Remove Exhaust**



6. If you have a 1984-93 vehicle, remove the QUAD Shock frame rail mounts by removing the two bolts on each side of the vehicle (Figure 3).



Figure 3 – Remove QUAD Shocks & Mount

7. Remove the interior plastic cover behind the back seat to gain access to the upper shock mount nut. Remove the nut with an impact wrench on both sides of the vehicle (Figure 4). Remove the shocks from the vehicle.



Figure 4 – Remove Upper Shock Nut

8. Remove the fuel filter bracket from the vehicle. Remove the fuel filter from the bracket (Figure 5).



Figure 5 – Remove Fuel Filter Bracket

9. Use a cut-off wheel to trim a section of the top flange of the mounting bracket. Cut to the other side of the stamped feature and then cut away at 45° (Figure 6).

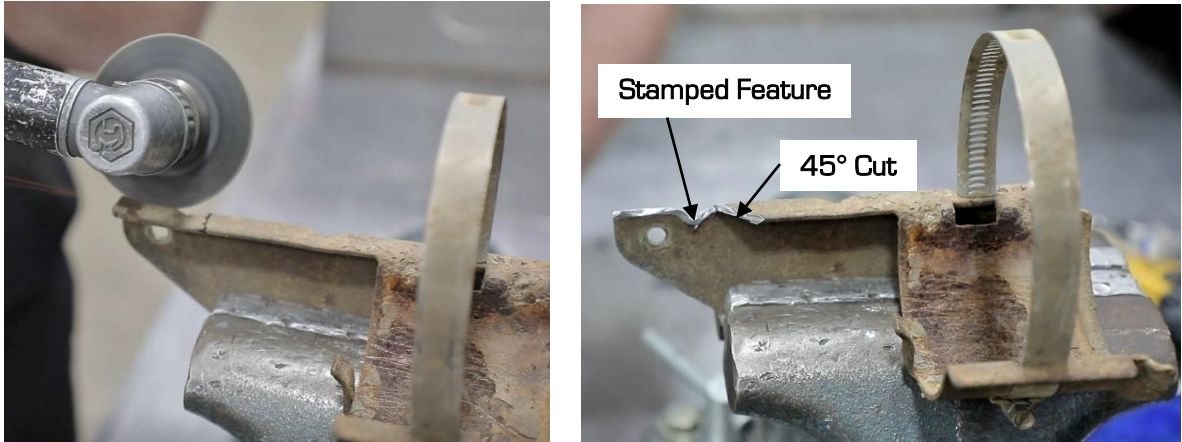

Figure 6 - Trim Fuel Filter Bracket

10. Re-install the fuel filter back into the bracket and back into the vehicle (Figure 7). Position the track bar frame rail brace assembly onto the passenger side framerail. Check the clearance from the track bar assembly to the fuel filter bracket, if the part still interferes, remove more of the fuel filter bracket.



Figure 7 - Re-install Fuel Filter

11. Drill out the pop rivet in the clamp holding the fuel line vent in place on the inboard side of the passenger frame rail. Carefully pull the fuel line vent away from the frame rail (Figure 8).

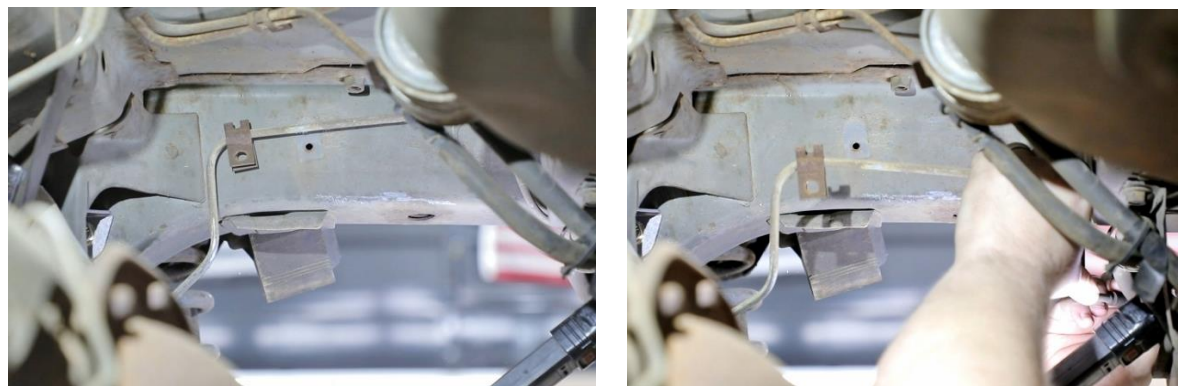

Figure 8 - Move Fuel Line Vent

12. If you have installed mini-tubs in your vehicle, skip to **Step 16**, otherwise continue on to the next step.



13. Using a straight edge, mark a location at the bottom of the upper shock mounting flange  $\frac{5}{8}$ " off the frame rail. Then, mark a location at the top of the upper shock mounting flange  $\frac{1}{2}$ " off the frame rail. Draw a vertical line on the flange connecting the two marked locations (Figure 9).



Figure 9 - Mark Trim Line

14. Using a cut-off wheel or an air saw, remove the section that was marked in the previous step between the upper shock mount flange and the frame rail (Figure 10). Repeat this process for the opposite side of the vehicle.



Figure 10 - Trim Upper Shock Mount Flange

15. Position the track bar frame rail brace assembly onto the frame rail. Make sure that the fuel lines are located underneath the track bar brace. Also make sure the outboard frame rail bracket fits between the upper shock mount flange and the frame rail that was modified in the previous step. Bend the upper shock mount flange back so it's no longer in the way of the middle mounting hole on the track bar frame rail brace. The flange should be bent back at about a  $45^\circ$  angle (Figure 11).



Figure 11 - Bend Upper Shock Mount Flange

16. If you have a 1984-93 vehicle, you can use the provided M12-1.75 x 30 button head screw and M12 washer to locate the body side bracket to the frame rail. Tighten the M12 button head screw to the frame rail. Transfer punch the three hole locations on the bottom side of the track bar frame rail brace assembly onto the bottom side of the frame rail (Figure 12). **NOTE:** Since the holes are slotted, you will need to transfer punch your hole locations, so they are centered on the hole centerline of the large fixture hole.

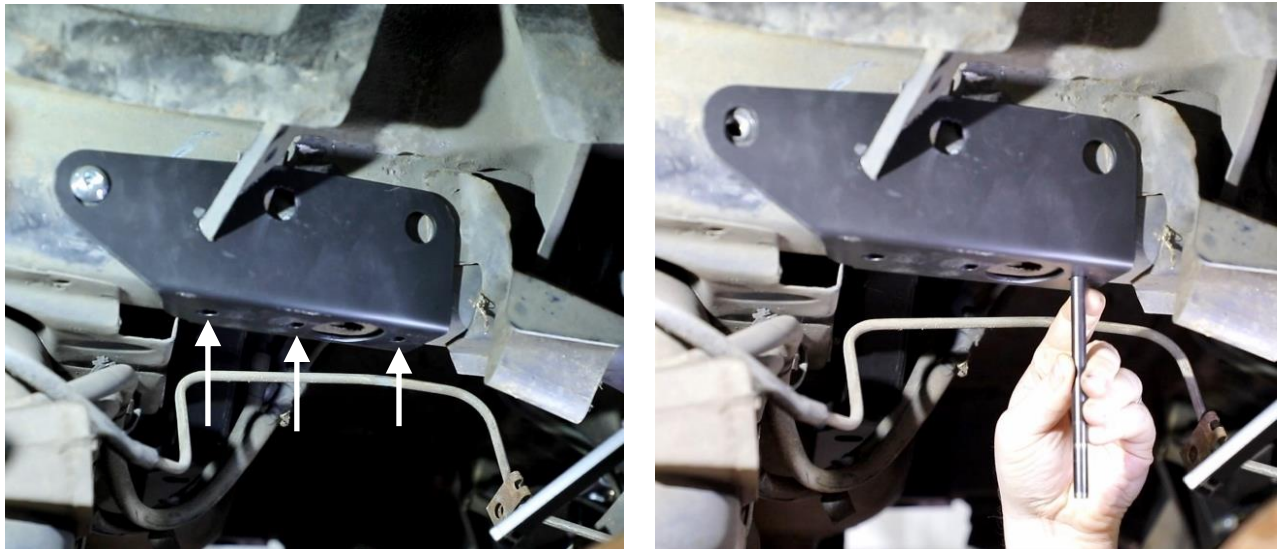

Figure 12 - Transfer Punch Frame Rail

17. Remove the track bar frame rail brace from the frame rail. Drill the three holes marked on the bottom side of the frame rail using an 11/32" drill bit. Then, drill out only the hole closest to the rear bumper using a 15/32" drill bit (Figure 13). **NOTE:** It is recommended that pilot holes be drilled first before drilling the 11/32" and 15/32" holes.

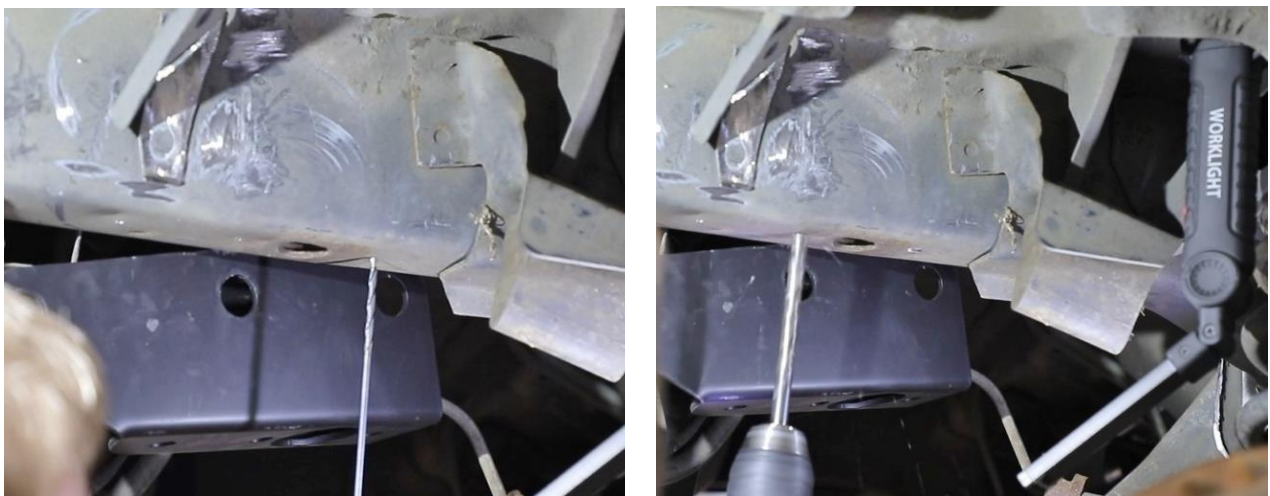

Figure 13 - Drill Bottom Frame Rail

18. Install one of the provided 5/16"-18 x 1" L hex head bolts into the provided single frame rail weld nut doubler plate. **NOTE:** You may want to run a 5/16"-18 and an 8-32 tap through the nut plate to make sure the threads are clean for the fasteners.
19. Wrap the threads of the 5/16"-18 bolt with masking tape. Place the threads of the bolt into the 11/32" drilled hole on the bottom side of the frame rail closest to the front of the vehicle (Figure 14 on the next page). Make sure the small hole is pointed towards the front of the vehicle and transfer punch the small hole on the nut plate to the bottom side of the frame rail.



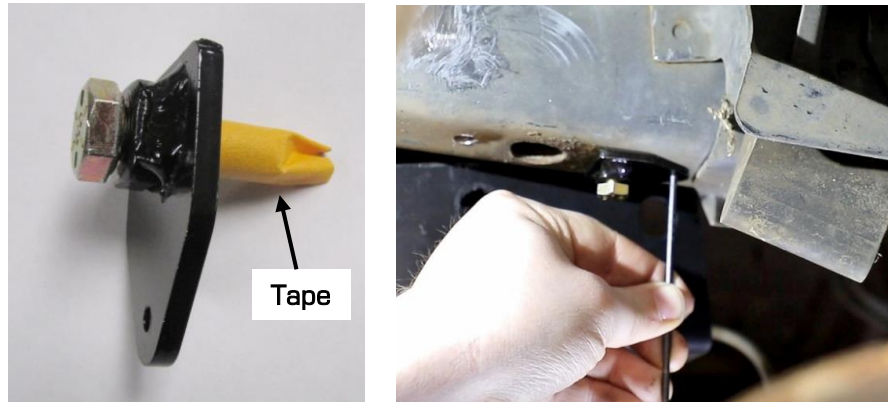

Figure 14 - Locate Single Weld Nut Doubler Plate

20. Next, install one of the provided 5/16"-18 x 1" L and one of the 7/16"-20 x 1" L hex head bolts into the double frame rail weld nut doubler plate. **NOTE:** You may want to run a 5/16"-18, 7/16"-20 and an 8-32 tap through the nut plate to make sure the threads are clean for the fasteners.
21. Wrap the threads of the bolts with masking tape. Place the threads of the bolts into the drilled holes on the bottom side of the frame rail closest to the rear of the vehicle (Figure 15). Transfer punch the small hole on the nut plate to the bottom side of the frame rail.

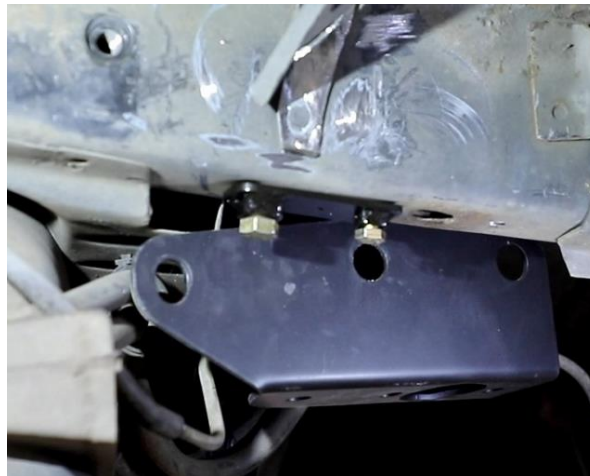

Figure 15 - Locate Double Weld Nut Doubler Plate

22. Drill the two holes marked on the bottom side of the frame rail from the previous steps using a 5/32" drill bit. **NOTE:** It is recommended that pilot holes be drilled first before drilling the 5/32" holes. Chamfer the holes using a large drill bit or chamfer tool until the provided 8-32 x 1/2" L flat head screw sits flush with the frame (Figure 16).



Figure 16 - Drill Doubler Plate Holes



23. In order to install the frame rail weld nut doubler plates, you can open up the 7/8" hole in the bottom of the frame rail to 1-5/8" (this is required when installing the Detroit Speed rear coilover kit PN: 042442DS). The other option is to pull them through the lower link hole in the frame by looping wire (You can use a clothes hanger) through the nut plates and pulling them up to the mounting location in the frame (Figure 17). **NOTE:** A magnet can also be helpful to line up the nut plate assemblies.



Figure 17 - Position Single & Double Weld Nut Plates

24. You can use the 5/16"-18 and 7/16"-20 hardware to help hold the weld nut plates in place while you install the 8-32 flat head screws. Use medium strength blue Loctite 242 on the threads of the screws and tighten. Install both weld nut plate assemblies into the frame rail and remove the wire (Figure 18). **NOTE:** You can use a drift to help line up the nut plates with the holes in the bottom of the frame.

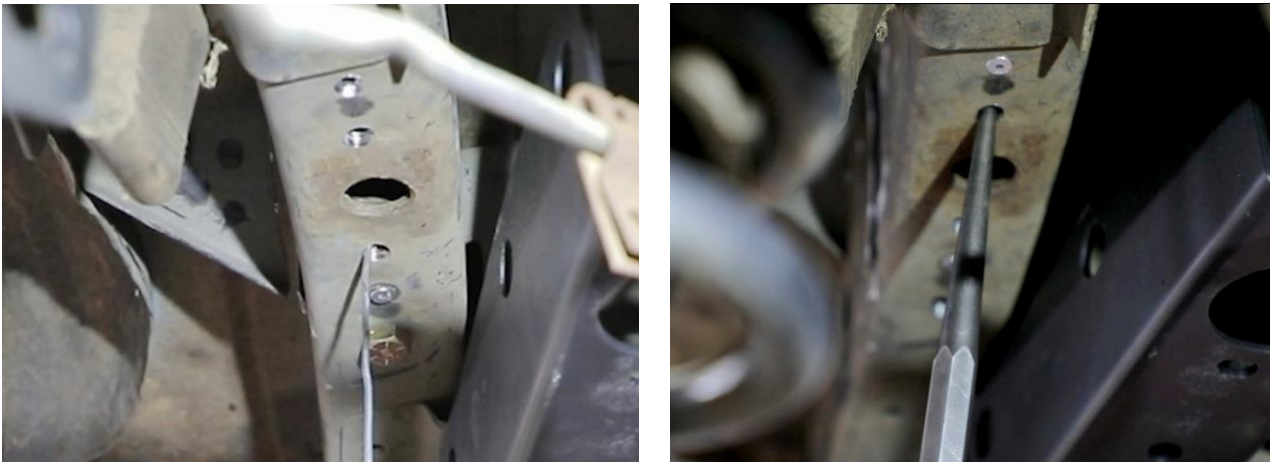

Figure 18 - Install Weld Nut Plates

25. Position the track bar frame rail brace assembly back around the frame rail. Install two of the provided 5/16"-18 x 1" L hex head bolts and 5/16" AN washers through the bottom side of the bracket, through the frame rail and into the single and double weld nut doubler plates that were installed in the previous step. Use medium strength blue Loctite 242 on the threads of the bolts and tighten.
26. Install one of the provided 7/16"-20 x 1" L hex head bolt and 7/16" washer through the bracket and into the double weld nut doubler plates (Figure 19 on the next page). Install the M12-1.75 x 30 button head screw with M12 washer into the outboard side of the frame rail if you are installing this kit on a 1984-93 vehicle. Use medium strength blue Loctite 242 on the threads of the bolts and tighten.

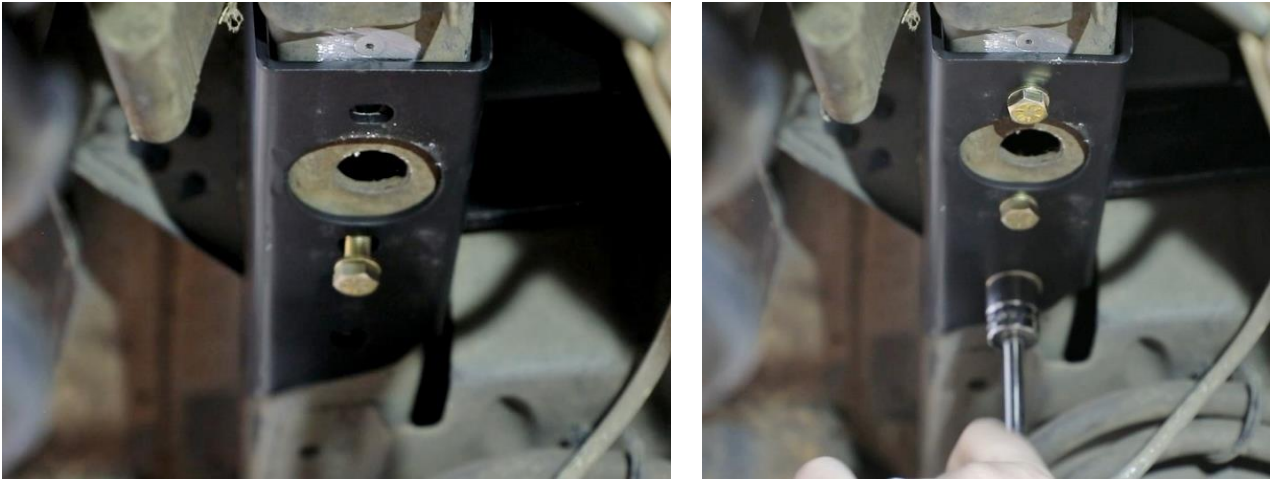

Figure 19 – Install Hardware into Weld Nut Plates

27. Next, drill two holes through the outboard side **only** of the frame rail. Use the two 3/4" holes on the outboard side of the track bar frame rail brace assembly as a guide using a 3/4" hole saw (Figure 20). You can also use a 3/4" Rota-Broach for this step. Chamfer the holes as needed. **CAUTION:** Be sure to keep the drill perpendicular to the frame rail as you will be installing crush sleeves through the frame rail.



Figure 20 – Drill Frame Rail Holes

28. Place two of the provided frame rail crush sleeves into the two drilled holes from the previous step. Place a 1/2" drill bit in the crush sleeves and spot drill the inner frame rail at both locations (Figure 21).

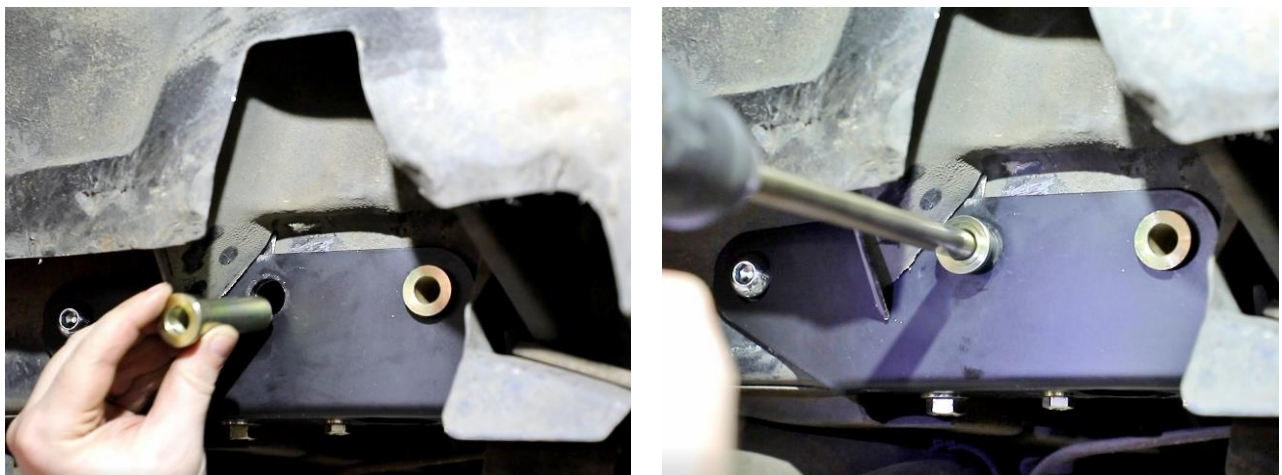

Figure 21 – Spot Drill Inner Frame Rail

29. Remove the crush sleeves from the frame rail. Use the provided 1/8" extended drill bit and locate the center of the spot drill location on the inner frame rail from the previous step. Drill through these locations using a 1/2" drill bit. **NOTE:** It is recommended that pilot holes be drilled first before drilling the 1/2" holes.
30. Place the crush sleeves back in the track bar frame rail brace and frame rail. Install one of the provided 1/2"-20 x 3-3/4" L hex head bolt and washer through the crush sleeve towards the front of the vehicle.
31. If you have factory wheel tubs, continue to the next step. If you have installed mini-tubs, install an additional 1/2"-20 x 3-3/4" L hex head bolt and washer through the crush sleeve towards the rear of the vehicle and skip to **Step 34**.
32. Locate the right and left hand track bar shock tower reinforcement bracket. The right hand bracket will have a "V" notch for identification (Figure 22).



Figure 22 - Right Hand Bracket

33. Place the right hand track bar shock tower reinforcement bracket so it sits against the upper shock mount flange and the track bar frame rail brace assembly. Adjust the factory flange as needed to fit the reinforcement bracket. Install the other 1/2"-20 x 3-3/4" L hex head bolt and washer through the reinforcement bracket, track bar frame rail brace and frame rail at the rearward crush sleeve (Figure 23).



Figure 23 - Locate Track Bar Shock Tower Reinforcement Bracket



34. Install the provided 1/2"-20 Nylock nuts and washers onto the bolts on the inboard side of the brackets and tighten (Figure 24). If you have factory wheel tubs, continue to the next step. If you have installed mini-tubs, skip to **Step 36**.



Figure 24 - Tighten Hardware

35. Using the track bar reinforcement bracket as a template, center punch and drill two 5/16" mounting hole locations through the factory upper shock mount flange. Install two of the provided 5/16"-18 x 3/4" L hex head bolts, Nylock nuts and washers through the upper shock mount flange and reinforcement bracket. Tighten the 5/16"-18 hardware (Figure 25).



Figure 25 - Install Track Bar Reinforcement Bracket

36. Next, place the body side track bar mount assembly to the driver side frame rail behind the rear axle. Center the hole in the bottom side of the frame rail with the large hole on the bracket. **NOTE:** If you have a 1984-93 vehicle, you can also use the provided M12-1.75 x 30 button head screw and M12 washer to locate the body side bracket to the frame rail. Tighten the M12 button head screw to the frame rail (Figure 26 on the next page).

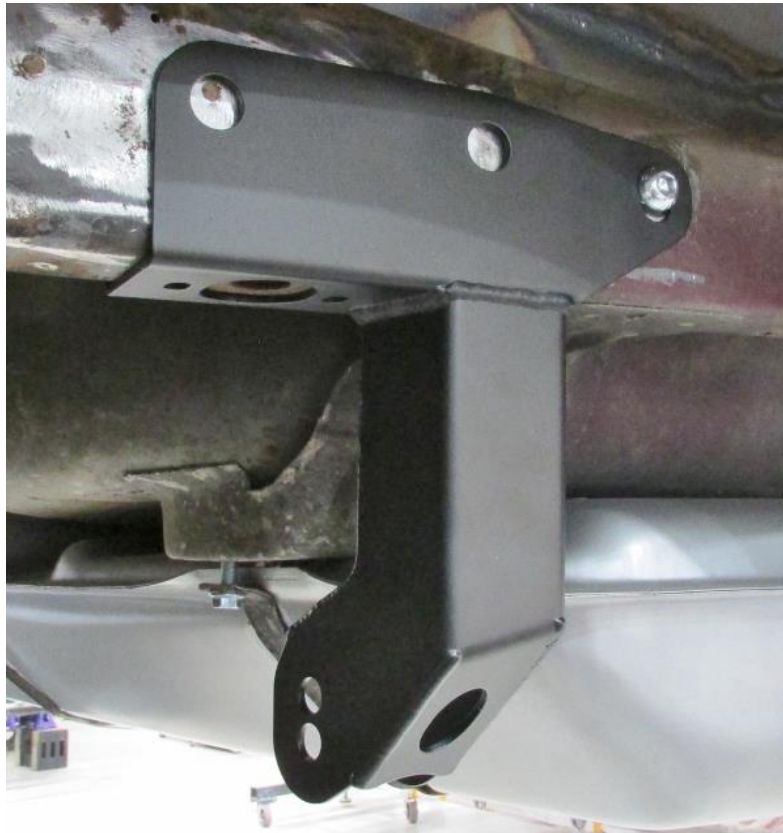

Figure 26 – Locate Body Side Bracket (Driver's Side)

37. Transfer punch the three bottom hole locations on the track bar mount to the frame rail, including the hole that has to be marked through the access hole in the track bar mount. Since the holes are slotted, you will need to transfer punch your hole locations, so they are centered on the hole centerline of the large fixture hole. **NOTE:** You can reach the bottom side of the frame rail by placing a 15/32" transfer punch in a socket with an extension and passing it through the access hole (Figure 27).



Figure 27 – Transfer Punch Bottom Frame Rail

38. Repeat Steps 17 through 30 for the body side track bar mount assembly on the driver side frame rail.

39. If you have factory wheel tubs, continue to the next step. If you have installed mini-tubs, install an additional 1/2"-20 x 3-3/4" L hex head bolt and washer through the crush sleeve towards the rear of the vehicle and skip to **Step 41**.



40. Place the left hand track bar shock tower reinforcement bracket so it sits against the upper shock mount flange and the body side track bar mount assembly. Install the other 1/2"-20 x 3-3/4" L hex head bolt and washer through the reinforcement bracket, track bar mount assembly and frame rail at the rearward crush sleeve (Figure 28).



Figure 28 - Locate Track Bar Shock Tower Reinforcement Bracket

41. Install the provided 1/2"-20 Nylock nuts and washers onto the bolts on the inboard side of the bracket and tighten (Figure 29). If you have factory wheel tubs, continue to the next step. If you have installed mini-tubs, skip to **Step 44**.



Figure 29 - Tighten Hardware

42. Using the track bar reinforcement bracket as a template, center punch and drill two 5/16" mounting hole locations through the upper shock mount flange. Install two of the provided 5/16"-18 x 3/4" L hex head bolts, Nylock nuts and washers through the upper shock mount flange and the reinforcement bracket. Tighten the 5/16"-18 hardware (Figure 30).



Figure 30 - Install Track Bar Reinforcement Bracket



43. Torque the 5/16"-18 hardware to 25 ft-lbs. Torque the 7/16"-20 hardware to 35 ft-lbs and torque the 1/2"-20 hardware to 70 ft-lbs on both brackets.
44. Carefully re-shape the fuel line vent on the inside of the passenger side so the clamp can be re-installed in the frame rail that was removed in Step 11. Place the provided 1/4" x 1" L self-tapping screw through the fuel line clamp and into the hole in the frame rail. Tighten the screw so it holds the clamp in place (Figure 31).



**Figure 31 - Re-install Fuel Line Clamp**

45. Install the track bar brace assembly onto the body side track bar mount assembly. Make sure the brace fits around the outside of the body side track bar mount on the driver's side.
46. Install one of the provided M14-2.0 x 80mm flanged head bolt to hold the brace in place (Figure 32). The body side track bar mount assembly has two holes separated by 3/4" for adjustability. The lower hole in the bracket is nominal for stock ride height. As you lower your ride height from stock you may want to use the upper hole in the body side track bar mount assembly.



**Figure 32 - Locate Track Bar Brace Assembly**

47. Position the end of the track bar brace with the two slotted holes to the track bar frame rail brace assembly on the passenger side. Place the provided track bar brace weld nut doubler plate assembly on the top side of the frame rail brace on the passenger side (Figure 33). **NOTE:** You may want to run a 7/16"-20 tap through the nut plate to make sure the threads are clean for the fasteners.



Figure 33 – Position Weld Nut Doubler Plate

48. Install two of the provided 7/16"-20 x 1" L hex head bolts and washers into the weld nut doubler plate. Tighten these bolts, however, do not torque them at this point. Carefully adjust the fuel lines by hand so they have clearance around the track bar frame rail brace assembly on the passenger side (Figure 34).

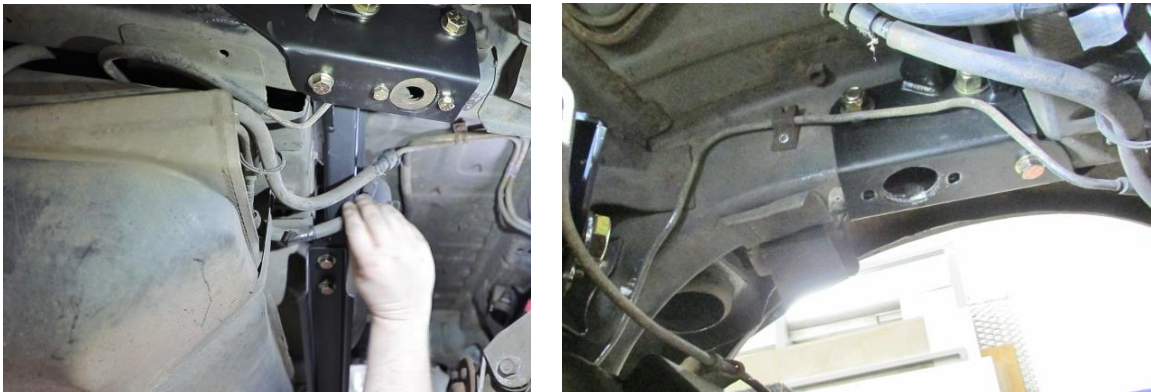

Figure 34 – Adjust Fuel Lines

49. Prepare the passenger side of the rear axle tube for the axle side track bar mount assembly by carefully adjusting the brake line away from the axle tube. Place the axle side track bar mount assembly around the back side of the axle tube so that the bottom surface of the bracket is parallel with the ground (Figure 35). **NOTE:** The passenger side of the track bar will drop down into the top side of the bracket.



Figure 35 – Position Axle Side Track Bar Mount



50. Install the provided 7/16"-20 x 2-3/4" x 4-1/2" L U-bolts from the front side of the axle tube and into the axle side track bar mount (Figure 36).



**Figure 36 - Install U-Bolts**

51. Install the provided 7/16"-20 Nylock nuts and washers onto the U-bolts. Tighten the hardware so the U-bolts are tightened evenly. Leave the track bar mount loose so it can be adjusted later (Figure 37).



**Figure 37 - Tighten U-Bolts & Hardware**

52. Position the track bar so it sits in the pocket of the axle side track bar mount. Raise the rear axle and place jack stands underneath the rear axle tubes so that the rear axle is at your desired ride height. Use a smart level to adjust the axle side track bar mount so that the bottom side is parallel with the ground (Figure 38).



**Figure 38 - Level Track Bar Mount**



53. Adjust the axle side track bar mount on the rear axle tube so the mounting hole in the track bar lines up with the mounting holes in the track bar mount. The track bar length has been pre-set and the jam nuts torqued during the assembly process at Detroit Speed.
54. Install the provided M14-2.0 x 80mm flanged head hex bolt through the track bar mount and track bar bushing (Figure 39). The top hole in the bracket is nominal for stock ride height. As you lower your ride height from stock you may want to use the lower hole in the track bar frame rail brace assembly. **NOTE:** The track bar should be as close to level as possible when at ride height. This is highly dependent on the desired ride height of the vehicle. You can use any combination of mounting holes to achieve a level track bar if your ride height is not adjustable.

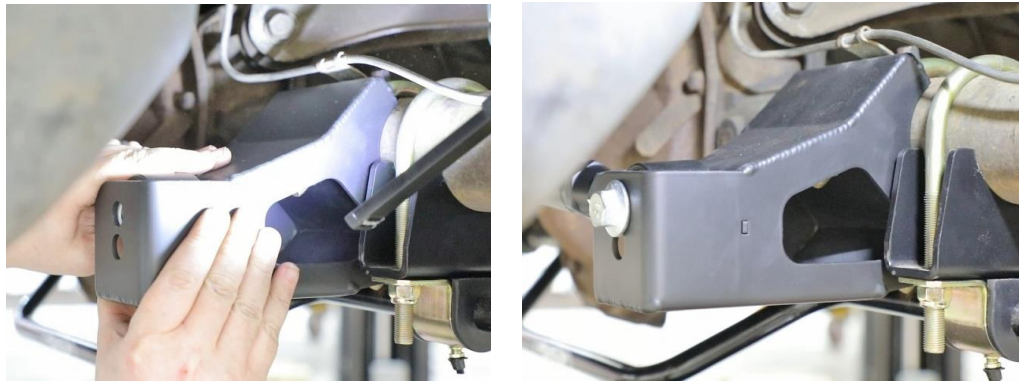

Figure 39 – Install Track Bar

55. Once the M14-2.0 hex head bolts are installed in the track bar, tighten the axle side track bar mount to the axle tube. Verify that the bottom side of the track bar mount remains parallel with the ground while you tighten the U-bolts (Fig. 40). Torque the U-bolts to 45 ft-lbs.

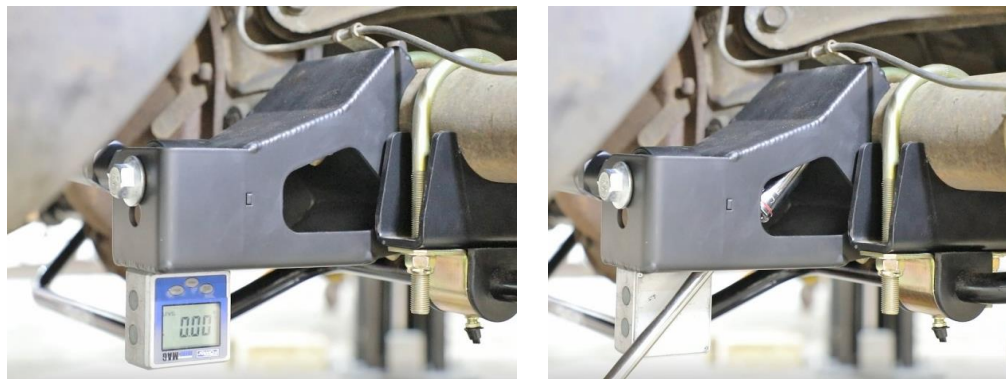

Figure 40 – Level Track Bar Mount

56. Install the provided M14-2.0 flanged lock hex nut on both M14-2.0 x 80 hex head bolts installed in the track bar and tighten (Figure 41).

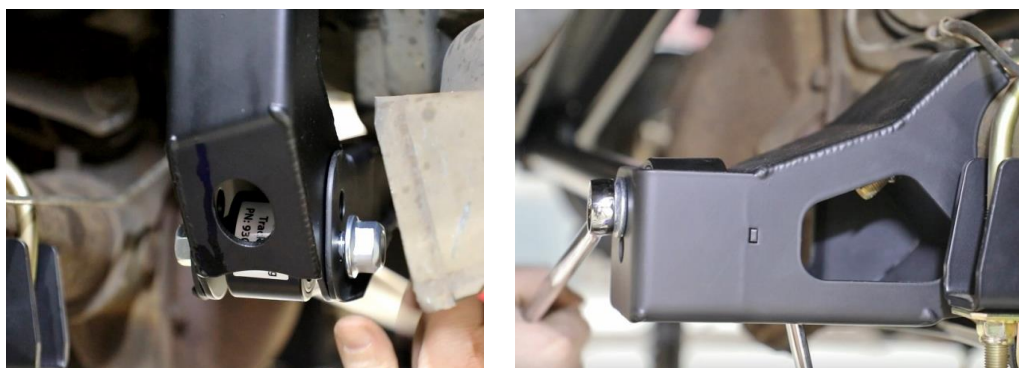

Figure 41 – Torque Track Bar Hardware

57. Re-install the shocks back into the lower shock brackets on the rear axle. Re-install your sway bar endlinks if equipped.
58. Raise the rear axle with a floor jack so the weight of the vehicle is on the rear suspension. Verify that the track bar does not interfere with the track bar brace assembly or the vehicle.
59. Torque the two 7/16"-20 fasteners in the track bar brace to the weld nut doubler plate in the track bar frame rail brace assembly channel to 40 ft-lbs.
60. Torque the M14-2.0 fasteners in the track bar to 120 ft-lbs. Verify the track bar axle bracket is level with the ground.
61. Verify that the rear axle is centered in the vehicle. It may be necessary to adjust the length of the upper and lower trailing links to center the rear axle if you are using aftermarket links.
62. Re-install the rear wheels and lower the vehicle to the ground. Torque the rear wheels to the manufacturer's recommended torque specifications.
63. Once the vehicle is settled at ride height, check to make sure there is no preload on the track bar. This can be done by loosening the jam nuts at both ends of the track bar and turning the track bar tube. Use a wrench on the hex portion of the tube to shorten or lengthen the track bar until it feels loose/free. **NOTE: There can be no more than 2" of exposed threads on the end links (3/4" of thread engagement in the tube).** This measurement does not include the jam nut (see page 20).
64. Once the track bar has been adjusted, torque the jam nuts to 50 ft-lbs.
65. If your exhaust goes around the rear axle, it will need to be modified before it can go back into the vehicle to fit around the track bar kit. Modify your exhaust as needed or have a local exhaust shop re-build the rear exhaust system as desired.
66. Installation is now complete (Figure 42).



Figure 42 – Track Bar Installation

If you have any questions before or during the installation of this product, please contact Detroit Speed at [tech@detroitsspeed.com](mailto:tech@detroitsspeed.com) or 704.662.3272

**Legal Disclaimer:** *Detroit Speed is not liable for personal, property, legal, or financial damages from the use or misuse of any product we sell. The purchaser is solely responsible for the safety and performance of these products. No warranty is expressed or implied.*



Detroit Speed  
Track Bar End-Link

**WARNING:**

There can be no more than 2" of exposed threads on the end link (3/4" of thread engagement in the tube). This measurement does include the jam nut (see below).

