

TRU
Track

SMALL BLOCK CHEVROLET

Installation Manual
For Systems without A/C
#13225 / #13125

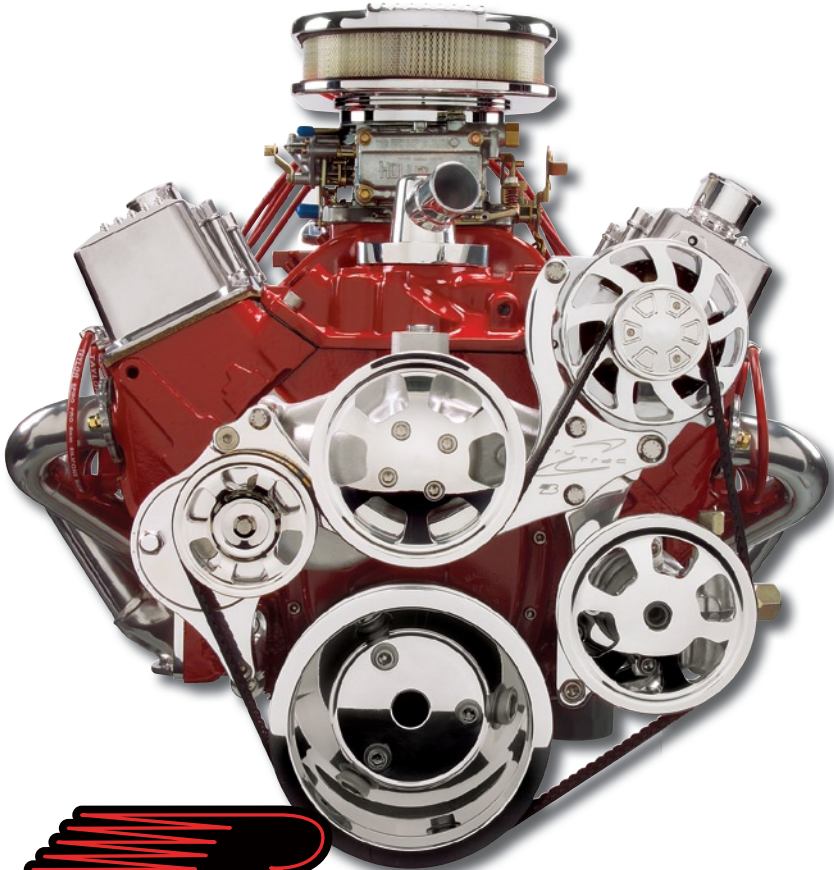

BilletSpecialties

Billet Specialties, Inc.

500 Shawmut Ave. • La Grange, IL 60526
Tech (708) 588-0505 • Fax (708) 588-7181

PLEASE READ ALL INSTRUCTIONS BEFORE INSTALLING ANY COMPONENTS OF THE TRU TRAC SERPENTINE SYSTEM

Tech Line: 708.588.0505
 Fax: 708.588.7181
 www.billetpecialties.com

Required Tools & Materials

- Anti-seize Compound
- LocTite 272 Thread Locker
- RTV Silicone
- Gasket Scraper
- Scotch-Brite® Pad
- 3/8-16 Thread Chaser* & Holder
*Thread chasers are available at your local parts store and are different from a thread cutting tap.
- 9/16" Combination Wrench
- 5/8" Combination Wrench
- 11/16" Combination Wrench
- 3/4" Combination Wrench
- 1/4" Hex Key
- 3/16" Hex Key
- 5/16" Hex Key
- 6mm Hex Key
- Socket Wrench & Extension
- 10mm 12pt. Socket
- 12mm 12pt. Socket

TECH TIP:

Billet Specialties recommends the use of Anti-Seize on all fasteners to prevent thread lock-up.

Packaged With Power Steering Pump

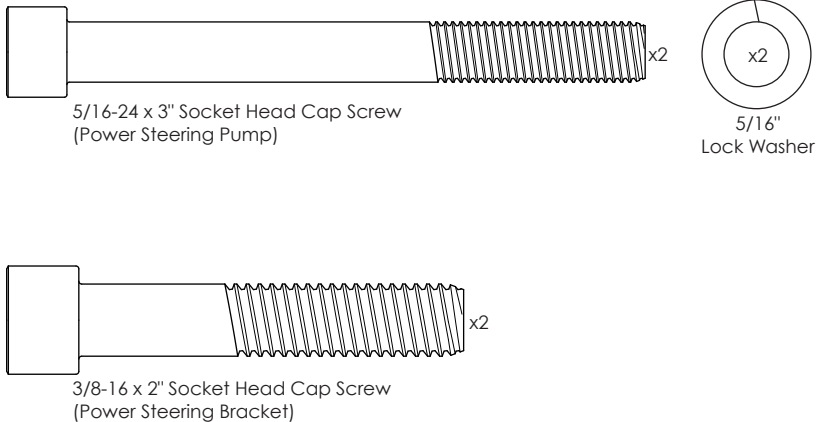

Preparing The Engine Block

- Disconnect the battery.
- Remove existing alternator, air conditioning compressor and associated brackets.
- Remove all pulleys and water pump.
- Remove all traces of gasket and sealer with gasket scraper and Scotch Brite® pad.
- Clean threads in block by chasing with a 3/8-16 thread chaser.

Included Serpentine Belt

| | | | | |
|-------------|----------|-------------------------|---------------|----------|
| With P/S | Goodyear | 6-Rib Poly-V Serpentine | Length: 50.5" | #4060505 |
| Without P/S | Goodyear | 6-Rib Poly-V Serpentine | Length: 48.5" | #4060485 |

Packaged With Water Pump

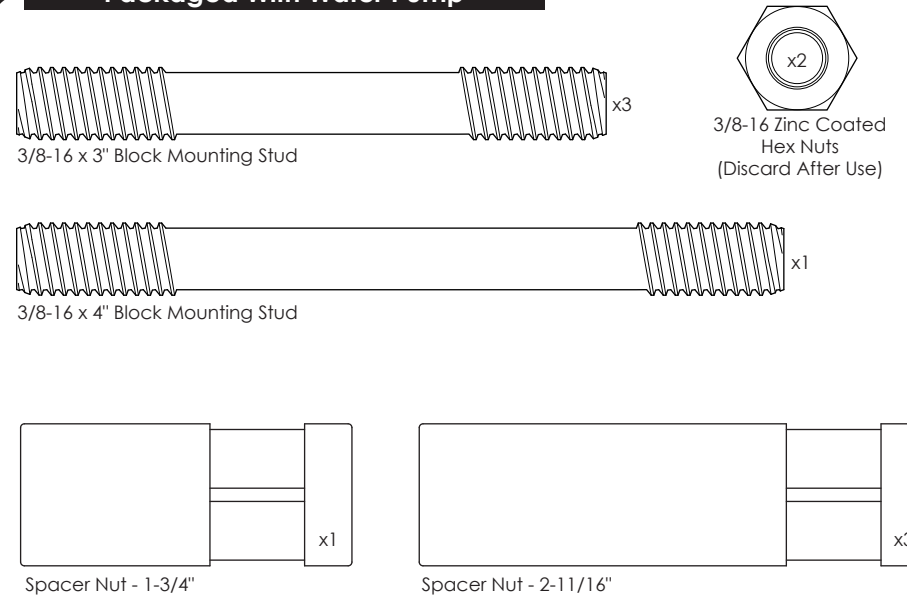

Packaged In Main Box

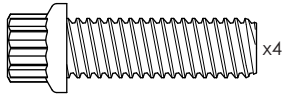

8mm-1.25 x 25mm 12pt. Cap Screw
(Bridge Bracket) x4

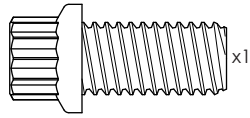

3/8-16 x 3/4" 12pt. Cap Screw
(Tensioner Pulley) x1

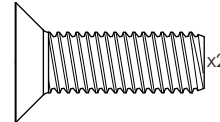

8mm-1.25 x 25mm Flat Head Cap Screw
(Bridge Bracket To Tensioner) x2

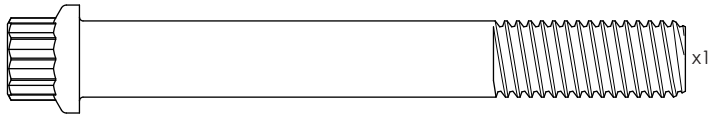

10mm-1.25 x 80mm 12pt. Cap Screw
(Alternator) x1

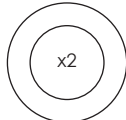

10mm x .5mm
Shim Washer x2

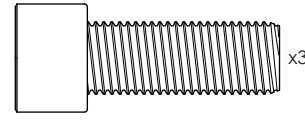

3/8-24 x 1" Socket Head Cap Screw
(Crankshaft Pulley) x3

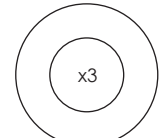

3/8" Belleville Washer x3

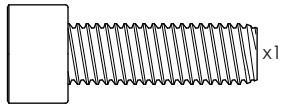

8mm-1.25 x 25mm Socket Head Cap Screw
(Tensioner) x1

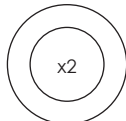

10mm x 1mm
Shim Washer x2

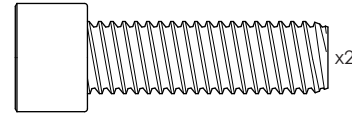

3/8-16 x 1-1/4" Socket Head Cap Screw
(Alternator Bracket) x2

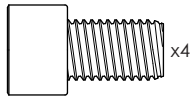

5/16-24 x 1/2" Socket Head Cap Screw
(Water Pump Pulley) x4

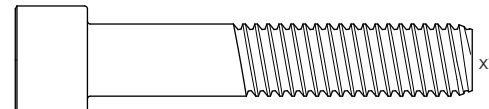

3/8-16 x 2" Socket Head Cap Screw
(Tensioner Bracket) x2

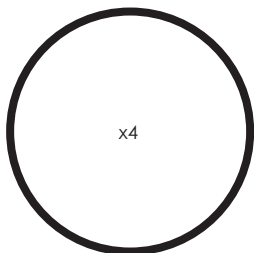

O-Ring Set x4



O-Ring Set x2

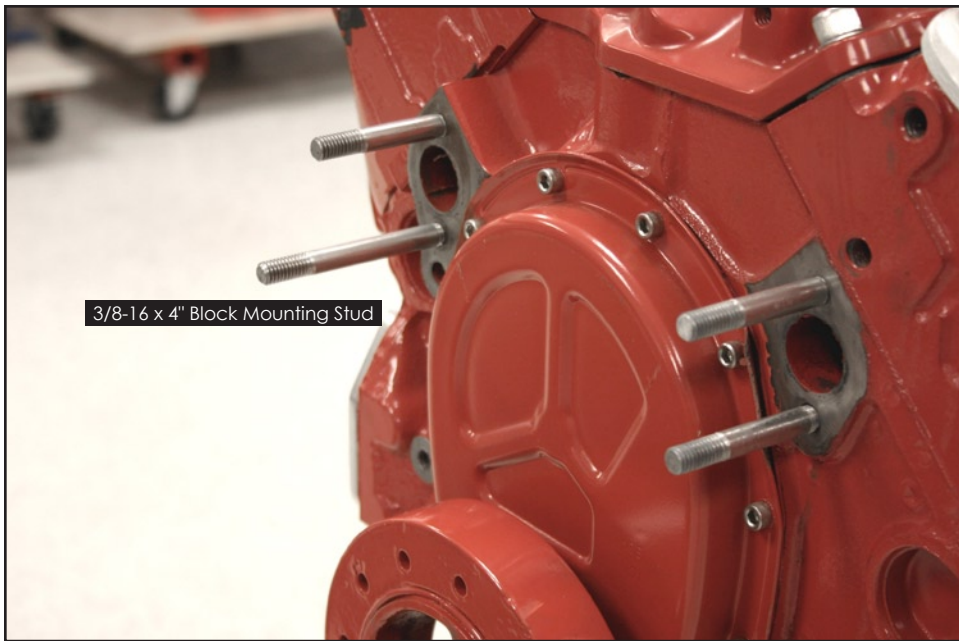

Figure 1: Install The Block Mounting Studs

Locate and apply RTV silicone sealant to one end of each of the four (4) block mounting studs and install into the water pump mounting locations. Thread into the block until the threads are completely seated into the block.

The longer 3/8-16 x 4" block mounting stud is to be installed in the lower passenger side water pump mounting location.

Tech Tip: Use the two (2) 3/8-16 hex nuts provided as a drive nut by tightening them against each other, see illustration below.

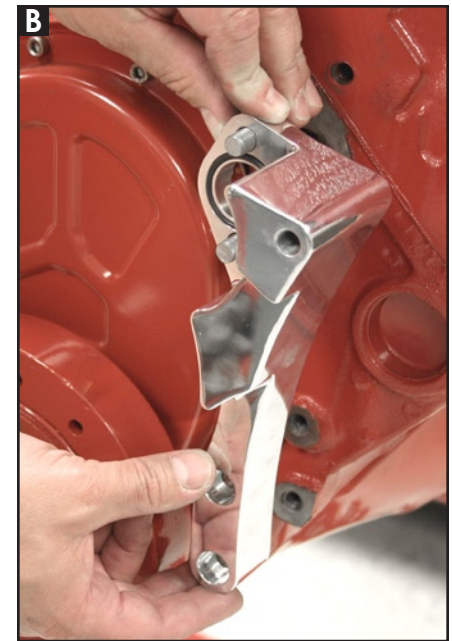
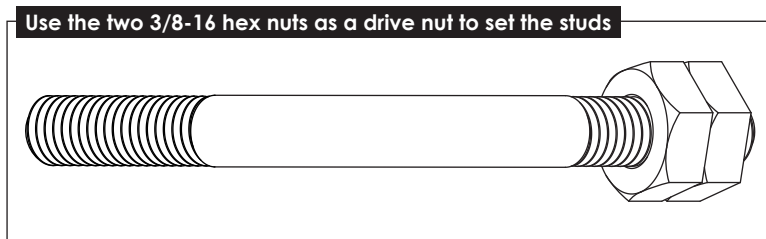

Figure 2: Install Water Pump Spacer & Alternator Bracket

Note: The water pump spacer & alternator bracket incorporate o-rings for sealing. Make sure to install the four (4) large o-rings for the water pump and the two (2) small o-rings for the bypass before installing.

A] Install the water pump spacer by sliding the spacer over the block mounting studs.

B] Install the alternator bracket as shown by sliding the bracket over the block mounting studs on the driver side of the engine.

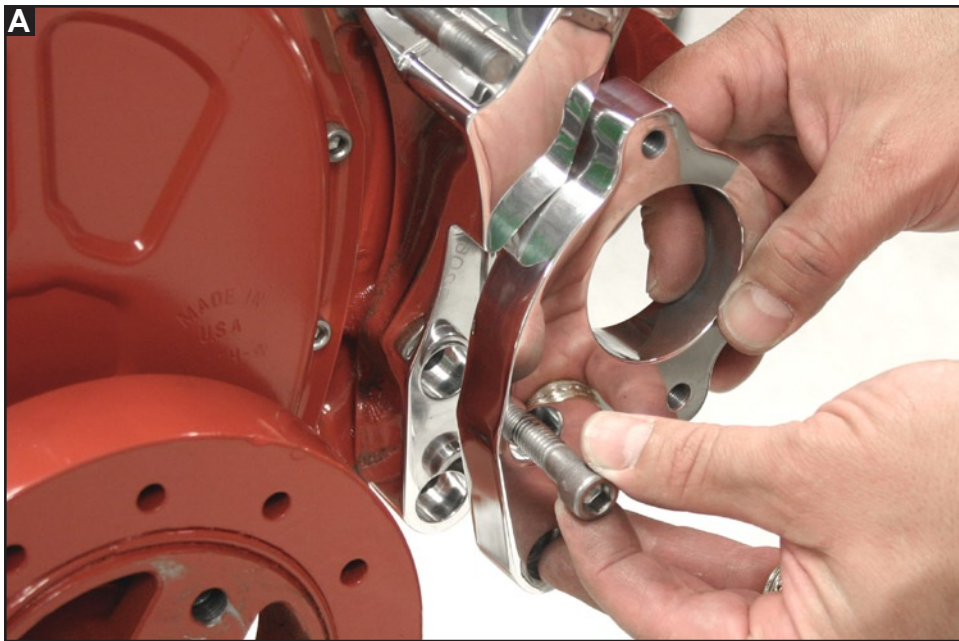

Figure 3: Install Power Steering Bracket

Kits Without Power Steering:

For kits without power steering apply anti-seize to the two (2) 3/8-16 x 1-1/4" socket head cap screws and install through lower end of the alternator bracket and into the block. Tighten firmly.

Kits With Power Steering:

A] For kits with power steering apply anti-seize to the two (2) 3/8-16 x 2" socket head cap screws and install by threading through the power steering bracket as shown above, through the alternator bracket and into the block. Tighten firmly.



Figure 4: Install Lower Tensioner Bracket

Apply anti-seize to two (2) 3/8-16 x 2" socket head cap screws.

A] Locate and install the lower tensioner bracket by threading the two 3/8-16 x 2" socket head screws through the bracket and into the lower mounting bosses on the passenger side of the block. Tighten firmly.

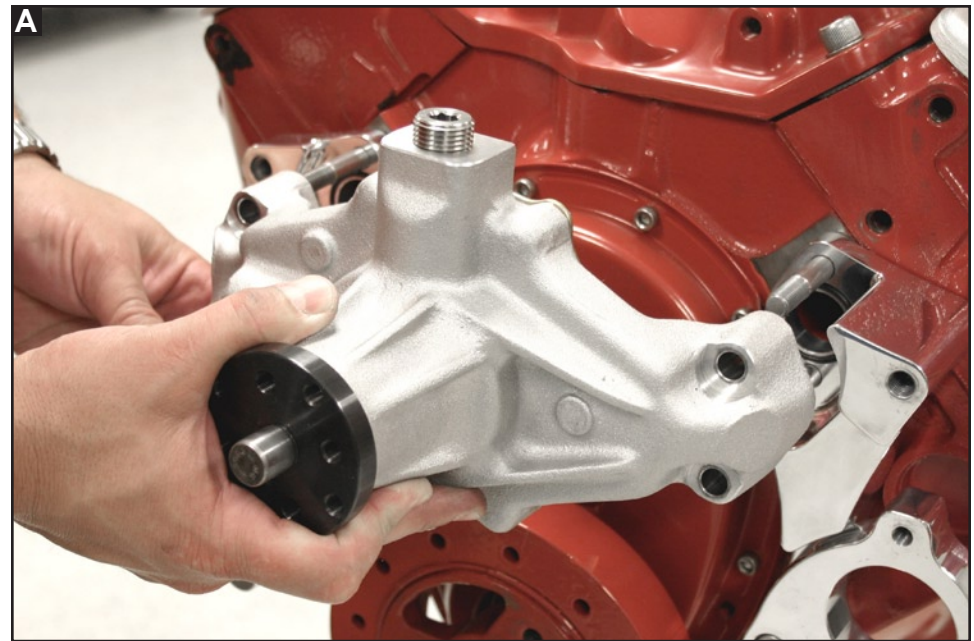

Figure 5: Install Water Pump

A] Install the included water pump by sliding the unit over the exposed ends of the block mounting studs previously installed.

Figure 6: Install Stainless Stand-offs

A] Apply anti-seize to the exposed threads of the block mounting studs and attach the stainless standoffs as shown with hex end out. Only hand tighten at this time.

B] Make sure to install the shorter (1-3/4") stainless stand-off on the lower passenger side block mounting stud as shown. Hand tighten at this time.





Figure 7: Install Tensioner

Install the tensioner by first applying anti-seize to one (1) 8mm-1.25 x 25mm socket head cap screw and one (1) 8mm-1.25 x 25mm flat head cap screw.

A] Align the tensioner and install the socket head screw through the tensioner and into the tensioner support bracket, install the flat head cap screw through the tensioner and into the lower water pump stainless stand-off. Tighten firmly.

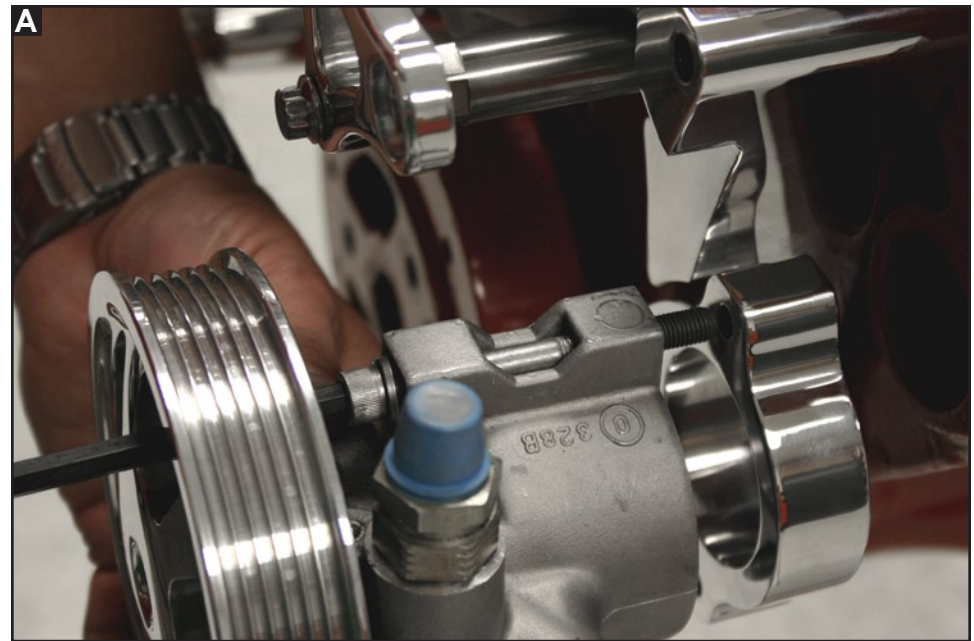

Figure 8: Install Power Steering Pump

Without Power Steering: Continue To Next Step.

With Power Steering:

Align the power steering pump with pre-installed pulley to the power steering bracket.

Apply anti-seize to the two (2) 5/16-24 x 3" socket head cap screws.

A] Using the two (2) 5/16-24 x 3" socket head screws with 5/16" lock washers, attach the power steering pump by threading the socket head cap screws through the pump and into the power steering bracket. Tighten firmly.

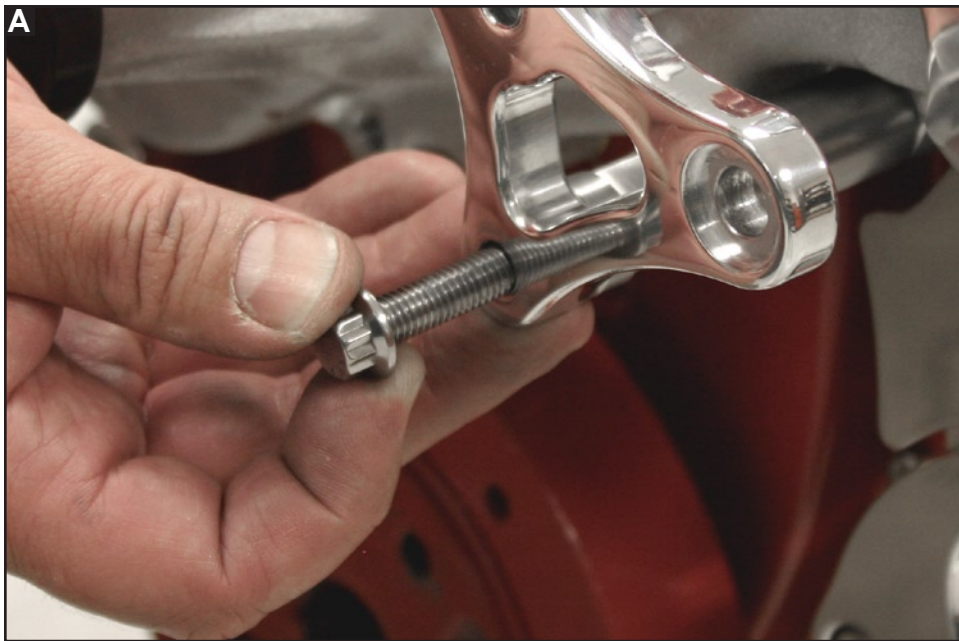

Figure 9: Install Bridge Bracket

Apply anti-seize to:

- Three (3) 8mm-1.25 x 25mm 12-point cap screws
- One (1) 8mm-1.25 x 25mm flat head cap screw

A] Align and install the bridge bracket using the three 8mm-1.25 x 25mm 12-point cap screws, threading into the stainless stand-offs. Install the 8mm-1.25 x 25mm flat head cap screw through the bridge bracket and into the boss on the tensioner housing. Finger tighten.

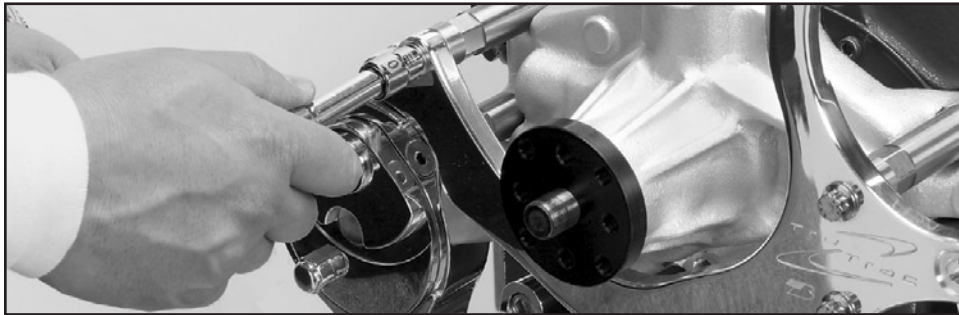

Figure 10: Tighten All Stand-offs & Bridge Bracket Hardware

- Firmly tighten the four (4) stainless stand-offs previously installed.
- After the stand-offs have been tightened, now tighten the 12-point caps screws and flat head cap screw that attach the bridge bracket.
- Re-check remaining hardware, all hardware should be tightened firmly at this time.

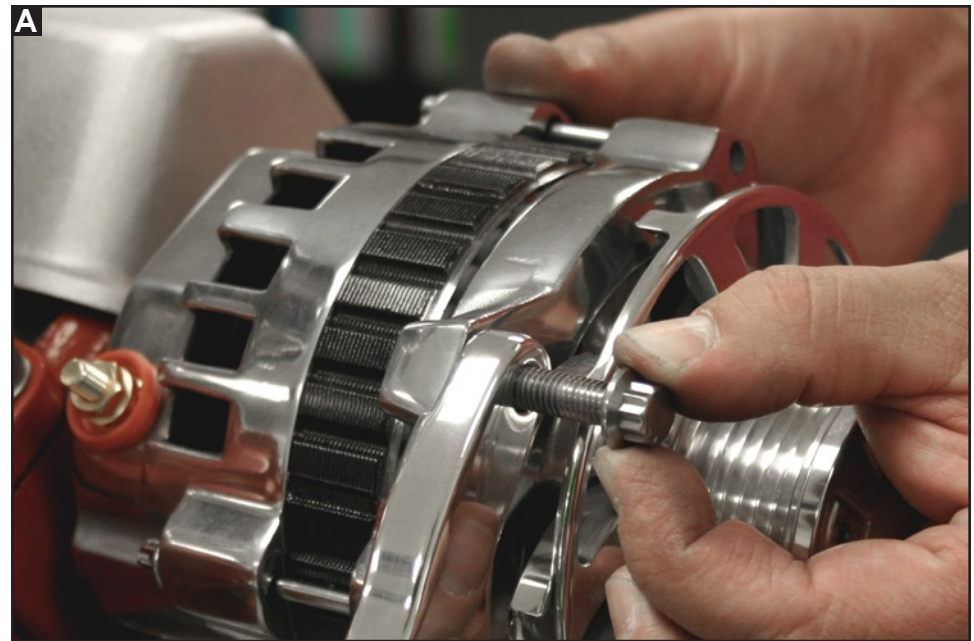

Figure 11: Install Alternator

Apply anti-seize to:

- One (1) 8mm-1.25 x 25mm 12-point cap screw
- One (1) 10mm-1.50 x 80mm 12-point cap screw

Align the alternator with the two mounting locations on the bridge bracket.

A] Install the 10mm-1.50 x 80mm 12-point cap screw through the lower mounting location on the alternator and finger tighten. Install the 8mm-1.25 x 25mm 12-point cap screw through the alternator and into the bridge bracket.

At this time tighten both fasteners firmly.

Note: Due to the polishing process the width of the mounting bosses may vary, 10mm shim washers are provided if needed for the lower mounting location.

Figure 12: Install Crank Pulley

Apply anti-seize to:

- (3) 3/8-24 x 1" Socket Head Cap Screws

Using three (3) 3/8-24 x 1" socket head cap screws with 3/8" Belleville washers align and install the crankshaft pulley. Cup on washer should go towards pulley. Torque to 35ft.lbs.

Note: Some crate engines will have a large center bolt and washer on the damper that will need to be removed before the pulley can be installed. This bolt should be replaced and installed after the pulley with a 7/16-20 x 2-3/4" bolt.



Figure 13: Install Water Pump Pulley

Apply anti-seize to:

- (4) 5/16-24 x 1/2" Socket Head Cap Screws

Align and install the water pump pulley using four 5/16-24 x 1/2" socket head cap screws. Tighten firmly.



Figure 14: Install Tensioner Pulley

Apply anti-seize to:

- (1) 3/8-16 x 3/4" 12-point Cap Screw

A] Align the tensioner pulley onto the tensioner's mounting boss. Install the 3/8-16 x 3/4" 12-point cap screw with aluminum load washer as shown. Tighten firmly.

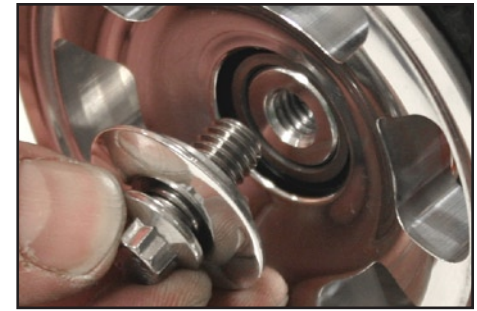
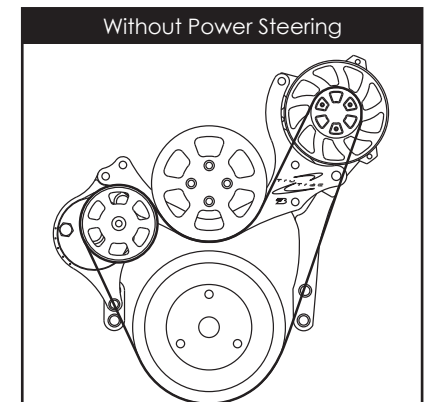
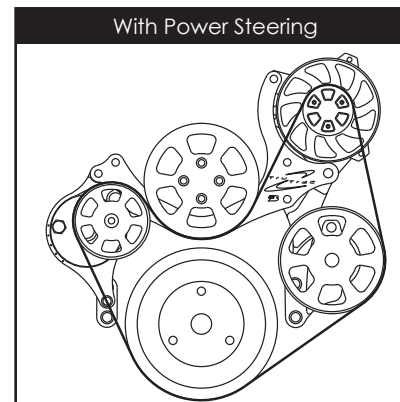

Figure 15: Install Serpentine Belt

With a 5/8" 6-point socket or wrench, turn the belt tensioner release nut clockwise to unload the spring tension and install the serpentine belt (routing shown below). Slowly return the tensioner to its starting position to apply tension to the belt.



#13225 / #13125



Billet Specialties, Inc.

500 Shawmut Ave. • La Grange, IL 60526
Tech (708) 588-0505 • Fax (708) 588-7181
www.billet specialties.com

