



Installation Instructions
81125
QUICKSILVER CONSOLE SHIFTER
1968-72 CHEVELLE & EL CAMINO

Rev. 1/15/2020

WORK SAFELY! For maximum safety, perform this installation on a clean, level surface and with the engine turned off. Place blocks or wedges in front of and behind both rear wheels to prevent movement in either direction.

CAUTION: To avoid any possibility of bodily injury or damage to vehicle, do not attempt installation until you are confident that the vehicle is safely secured and will not move.

The B&M QuickSilver Shifter is a dual action shifter incorporating straight gate operation and ratchet operation in one mechanism. The styling and appearance will definitely add to the interior of your vehicle.

The straight gate operation allows you to quickly and smoothly select any gear you want for daily driving from Park to Drive. The ratchet shift feature provides crisp, error free upshifting and downshifting on the street or track. In the ratchet shift mode, it is impossible to overshift or miss a gear. The vertical lockout design prevents accidental engagement of Reverse during ratchet shifting.

This shifter is designed to work with an automatic, manual valve body utilizing standard or reversed shift patterns. Your shifter also comes supplied with all brackets and parts to work with your transmission.

WARNING: this install will require modification to the floor. A 1-1/2" hole will need to be drilled out to re-position the shifter cable.

INTRODUCTION

The main mechanical components of this shifter are factory assembled. Any modification or disassembly of these parts can cause shifter malfunction and will void the warranty.

NOTE: This shifter has been configured from the factory for 3-speed automatic transmissions. For 4-speed automatic transmission use, remove the E-clips at the back of the shifter and the attached cross-pin. The e-clip and cross pin will NOT be used in 4-speed operation.

DISASSEMBLY

1. Disconnect the negative cable from the battery.
2. Remove the six (6) screws that are securing the shifter cover plate to the console.

TOOL: Philips Screwdriver



3. Lift the shift indicator assembly from the console, unplug the two (2) bulb harnesses from the shift indicator assembly and set aside.



4. Remove the top plate.



5. Remove the two (2) screws that are securing the center of the console to the shifter.

TOOL: Philips Screwdriver



6. Remove the two (2) screws that are securing the front end of the console to the floor.

TOOL: Philips Screwdriver



7. Remove the two (2) screws that are securing the rear of the console to the rear bracket mounted to the floor. You must open the compartment door to access screws.

TOOL: Philips Screwdriver



8. Disconnect the electrical harnesses from the shifter module: Neutral Safety Switch, Reverse Back-Up Light connectors.



9. Remove the four (4) screws securing the rear light panel to the console. Remove the panel and set aside.

TOOL: Philips Screwdriver



10. Remove center console.



11. Remove shifter cable retaining clip.

TOOL: Pliers



12. Remove the retaining clip that is securing the end of the shifter cable to the shifter. Then remove the cable from the shifter.

TOOL: Small flat head screwdriver



13. Remove the four (4) screws that are securing the shifter to the floor. Remove the shifter.

TOOLS: 3/8" Socket, Extension, Ratchet



14. Lift the vehicle and support the vehicle with jack stands. Go underneath the vehicle and detach the cable from the transmission. Remove the old shifter cable. Since the opening for the original cable is no longer being used, a plastic plug has been provided to plug the original hole.

TOOLS: Jack & Jack Stands



15. The shifter cable opening will have to be re-positioned which requires a 1-1/2" hole to be cut in a specified location. Temporarily install the bracket to the floor allowing the bracket to be adjusted. Temporarily install the console to line up the bracket. Now that the bracket has been aligned, tighten the screws to hold the position of the bracket to the floor and then remove the console. Use a marker to trace the large circular opening from the bracket to the floor. This is where the cable will be re-located. Use a ruler and pencil to determine center of hole. Use a center punch and hammer to mark the center.

TOOLS: Ruler, Pencil, Marker, Center Punch, Hammer

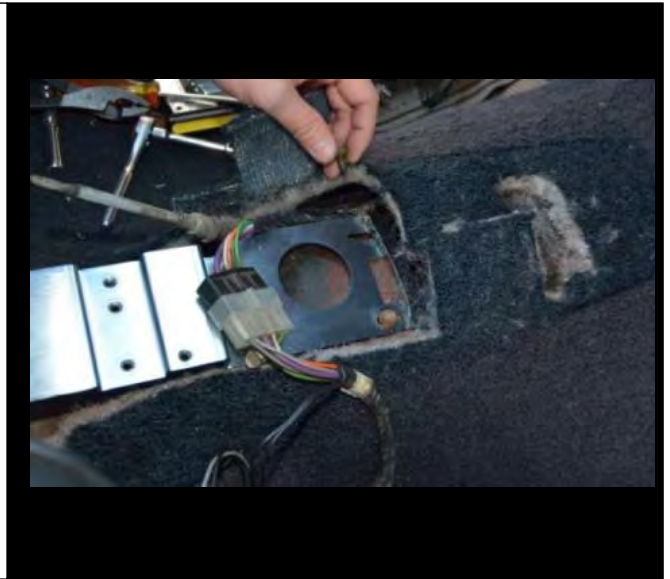

16. Drill out the hole.

TOOLS: 1-1/2" Hole Saw, Centering Drill Bit, Electric Drill.

CAUTION: Take your time and be careful. Drill just far enough to create the hole. Going any further than that may result in damage to the transmission case.



17. From underneath the vehicle, install the B&M selector lever in position on the transmission. Re-use the stock selector lever nut. Torque the nut to 23ft.lbs. The lever should move smoothly from front to back with a positive click in each gear position.

TOOLS: 3/8" Socket, Ratchet, Torque Wrench



18. Remove the two transmission oil pan bolts from the middle of the left side of the oil pan. Install the cable bracket in position. The bracket must be installed with spacers between the pan and the bracket. Install two 5/16 x 1.00" bolts (or M8 x 25 mm for metric transmissions) supplied and tighten 12-13 ft. lbs. Do not overtighten as this can damage the pan gasket.

TOOLS: 5/16" Socket, M8 Socket, Extension, Ratchet, Torque Wrench



19. Slip the rubber grommet onto the cable and run it all the way up to the cable end that will connect to the shifter. Route the shifter cable in a large loop to avoid kinks and sharp bends, and route the cable away from the hot engine or exhaust parts. Remove the two rubber boots, one large nut, and a large lockwasher from the threaded end of the shifter cable. Slide the end of the cable into the cable bracket. Install the large nut and the lockwasher loosely by hand over the end of the cable. Install two rubber boots onto the end of the cable. Install the swivel on the threaded end of the cable and position it in the center of the threaded portion.

20. Mount the indicator light socket to the B&M mounting bracket. A #6x1/2" self-drilling screw has been provided to drill directly into the bracket at any open location.

TOOLS: Electric Drill, Philips Bit

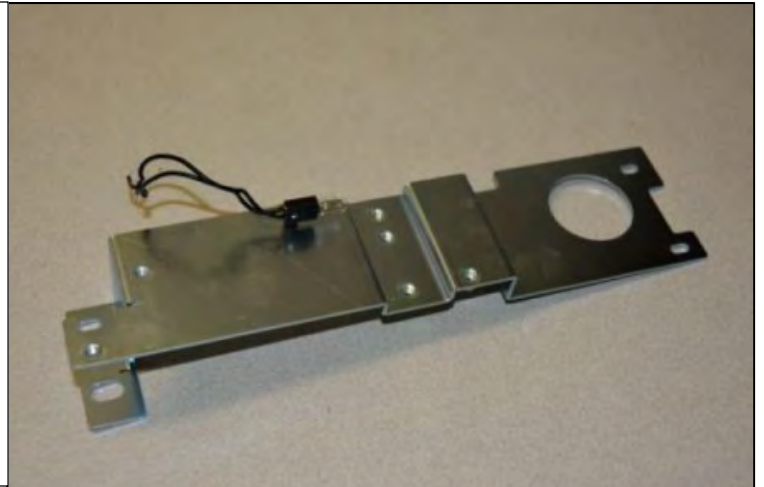

21. Install the bracket with the four (4) 1/4"-14 drilling screws and 1/4" washers.

TOOLS: 3/8" Socket, Extension, Ratchet.



22. Install the console.



23. You will notice that when attempting to install the shifter that the console's plastic bracket is covering up a mounting point for the shifter. You will have to mark this position and drill out the hole to allow for a screw to be inserted. A gap will exist between the shifter and the bracket at this location. For this very reason, a plastic spacer has been supplied for added support. Mark where the hole needs to be drilled out, remove the console and CAREFULLY drill out the hole with a 5/16" drill bit.

TOOLS: Marker, 5/16" Drill Bit, Electric Drill



24. Re-install console. Secure the center of the console to the bracket with two (2) of the 1/4"-20 socket head cap screws provided in the hardware kit. Re-use the original screws to secure the front and rear of the console.

TOOLS: 3/16" Hex Key, Philips Screwdriver



25. Install shifter. Secure the shifter to the bracket with four (4) of the 1/4"-20 socket head cap screws provided in the hardware kit. A spacer has also been provided to add support between the upper left mounting point of the shifter to the bracket. If the console is OEM then it might require further modification to utilize the spacer.

Insert the cable through the B&M QuickSilver shifter and install with 1/4"-20 x 1/2" Cap Screw, 1/4" Nut and 1/4" washer. Install the E-Clip that secures the cable to the cable pin.

TOOLS: 3/16" Hex Key, 1/4" Wrench, 1/4" Socket, Ratchet

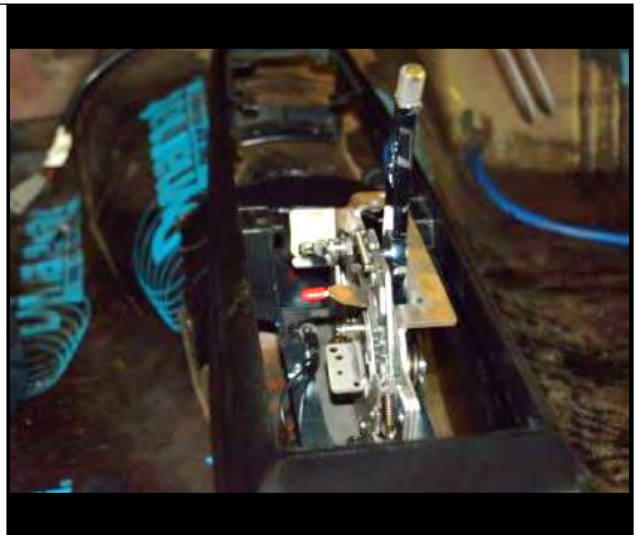

26. Assemble the neutral safety and reverse light switches to the bracket using two (2) 4-40 x 1-1/4" screws, two (2) 4-40 lockwashers, and two (2) 4-40 nuts. Splice the Neutral safety switch and reverse light switch to the OEM harness using the supplied blue connectors

Neutral Safety Switch wires: Dark Purple & Purple with White stripe(s).

Reverse Light Switch wires: Green & Dark Green

TOOLS: 1/4" Wrench, Small flat head screwdriver, Wire Cutters



27. Wire the indicator light. Connect one wire from the socket to a shifter mounting bolt. If your car had an indicator light on the shifter, cut the old socket off and connect the wire to the new light socket. Otherwise, run a length of wire from the instrument panel light switch to the new light socket. Tape all the connections and splices to avoid shorts. Install the supplied light bulb.

TOOLS: Wire Cutters, Electric Tape



28. From underneath the vehicle, move the transmission selector lever by hand to full rear position (Low). Operate the shifter lever to the Low gear position (ratcheted all the way back towards the rear of the vehicle). Adjust the large nuts on the cable so that the swivel will slide into the front hole on the selector lever. Tighten the large nuts completely. Be sure that the swivel will slide freely in and out of the hole in the selector lever.

Note: The shifter will not operate correctly unless the front hole in the shift lever is used.

TOOLS: 7/16" Wrench x 2



29. Leave the swivel out of the hole and move the selector lever to Park, all the way forward towards the front of the vehicle. Also move the shifter to the Park position (all the way forward). Re-insert the swivel into the front hole in the selector lever. Check to see that the swivel will slide freely in and out of the front hole in the selector lever in this position. If it does not slip in freely, adjust the swivel slightly until it will slip into the hole in the lever.

Move the shifter back to the Low gear position and check that the swivel will still slide easily in and out of the front hole in the selector lever. Operate the shifter through all the gear positions. Check to make sure the swivel will slide in and out of the front selector lever hole in each gear position. The shift cable is now correctly adjusted. Install the cotter key supplied with the shifter into the swivel and spread the key ends. If you have a problem, **DO NOT FORCE THE SHIFTER**, this will damage the cable, the shifter or the transmission. Simply start at the beginning and carefully check all your steps.

30. Snap the indicator window in place on the chrome shifter cover. The window snaps in from the top with the tabs inserted under the cover. Insert the black boot into the lip of the chrome cover. Make sure it is retained on all four sides. Slip the cover over the shifter handle and fasten it to the console with four (4) 8-32 x 1/2" Phillips screws supplied in the kit. **Do not overtighten the screws** or you may crack the cover or strip the threads in the center console.

TOOL: Philips Screwdriver



31. With the B&M QuickSilver shifter in the Neutral position, check the cable adjustment on the transmission. If you must raise the vehicle, use jack stands, wheel ramps or a hoist and make sure the vehicle is well supported. Remove the cable clip and pull the cable eyelet off. The eyelet must slide off and on the pin without binding. If not, adjust the cable pin by loosening the nut and moving the cable pin until the eyelet will slide on. Retighten the cable pin nut. Move the shifter to the First Gear position. (Third Gear on reverse pattern valve bodies.) Recheck the cable pin to eyelet fit. Re-adjust if necessary, and check the Park position. Install the cable clip.

Note: The stock linkage to the steering column must be left intact or the neutral safety switch, backup light switch, and column lock will not function.

32. Lower the vehicle and re-connect the battery. Start the engine and check the shifter installation. **The engine must start in Park or Neutral only. The backup lights should work in Reverse only.** Turn the lights on and check the indicator light. If your B&M QuickSilver shifter is not working properly, do not drive your vehicle. Make certain you have followed all instructions. If the shifter is broken or does not function properly, contact your B&M dealer.

33. Tighten the knob on the handle. You may wish to use a small amount of Loctite or a similar product on the threads to keep the knob tight. Position the knob insert and align the B&M QuickSilver name, push down on the insert to snap it in place.



SHIFTER OPERATION

The B&M QuickSilver shifter combines a straight gate and a ratchet shifter into one mechanism. Refer to the following instructions for proper operation:

Straight Gate Mode: In the upper position, the shifter functions in the straight gate mode. The handle travels in a direct line forward and backward from Park to Drive. The shifter handle must be raised up to clear the stop gates while going through the gear positions (See Figure #1).

***NOTE:** 3-speed shown. 4-speed action identical with one extra ratchet gate position.

Fig. 1

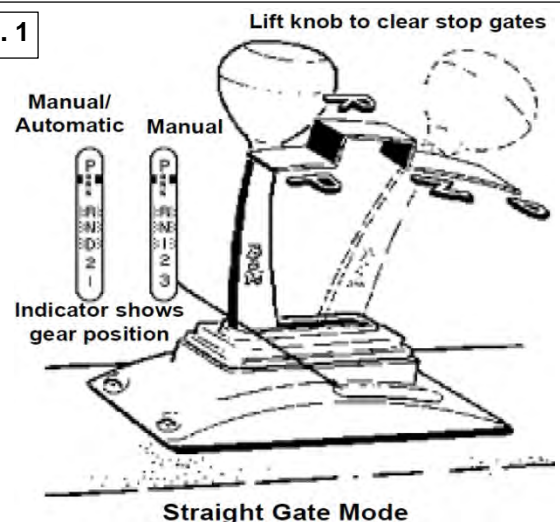

Park: To get to park from any straight gate position, lift the handle all the way up and push forward. The transmission will find its own Park position. Release the handle and the shifter is locked in Park. To get any other gear position, you must raise the shifter handle to clear the stop gate.

Reverse: Raise the shifter handle to clear the stop and move the shifter handle to the Reverse position.

Neutral: Move the shifter handle to Neutral. You do not have to raise the shifter handle unless you are in Park.

Drive: Move the shifter handle to Drive. You do not have to raise the shifter handle unless you are in Park.

Second and First gear cannot be selected with the shifter in the straight gate mode.

Ratchet Shift Mode: The ratchet shift mode allows firm, positive, no-miss upshifts and downshifts in First, Second, Third (Drive) and Neutral. Reverse and Park cannot be selected in the ratchet shift mode.

To switch from straight gate to ratchet operation, first have the shifter handle in the Drive position. With the shift handle in the Drive position, push down firmly on the knob to engage the ratchet mode. The handle will snap down approximately 3/4". The shifter is now in the Drive (Third) gear position for automatic valve bodies or the First gear position for full manual valve bodies (See Figure #2).

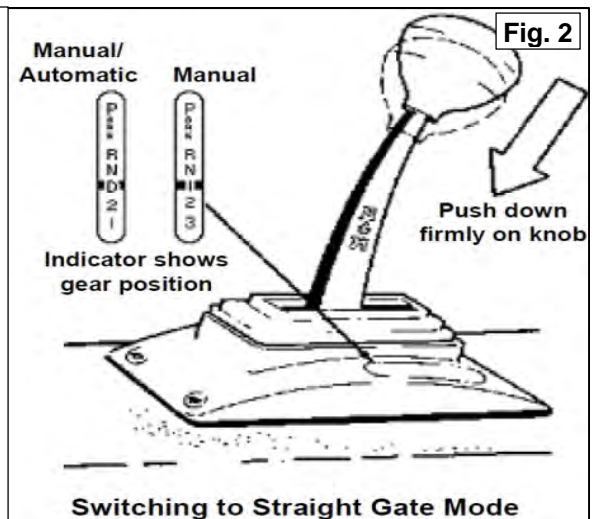

Shifting and the ratchet mode: Move the shift handle forward or backward with a quick firm action until it hits the internal stop. **Caution:** Do not lift the shifter handle when making ratchet shifts. Release the shifter handle and allow it to spring return to the center position. The shifter is now ready for the next shift (See Figure #3). Refer to the shift indicator for gear position in the ratchet mode.

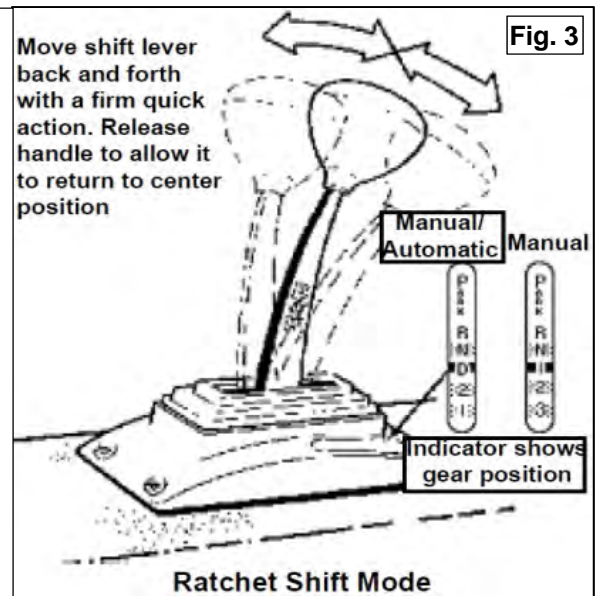

When the shifter has reached the extreme rear gear indicator position, the shift lever will contact an internal stop and you will not be able to ratchet the shift handle towards the rear. The shifter is capable of ratcheting all the way to Neutral. When the shifter has reached the Neutral position, the handle will no longer push forward. Ford and Chrysler applications have only one ratchet step between the Reverse and Park position. General Motors applications require two ratchet steps between Reverse and Park. Do not attempt to force the shift lever ratchet steps on Ford or Chrysler applications as this may cause damage to the cable and/or shifter mechanism.

To switch the shifter from the Ratchet mode back to straight gate operation, operate the shifter to the Drive (automatic valve bodies) or the First (manual valve bodies) gear position, pull firmly on the knob to engage the straight gate mode. You are now in Drive (automatic valve bodies) or First (manual valve bodies) in the straight gate mode (See Figure #4).

Remember: To switch from Straight Gate to Ratchet mode or Ratchet mode to Straight Gate you must be in the Drive (automatic valve bodies) or the First (manual valve bodies) gear position. Refer to the shift indicator for the gear position (See Figure #2 & #4).

Fig. 4

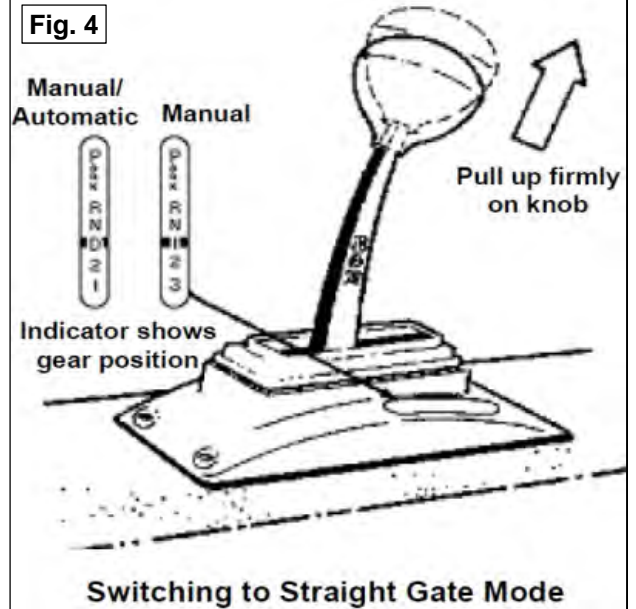

SPECIAL NOTE: If the instructions for operating your shifter seem complicated, do not be alarmed. You will find that, in actual use, the shifter will be extremely easy to operate after a minimal amount of experience.

Caution: The shifter is an important controlling mechanism of your vehicle and can create serious driving hazards when any part is loose, missing or misadjusted. After you have installed your B&M QuickSilver shifter we recommend you review the following check list and mark each point to assure a complete and proper installation.

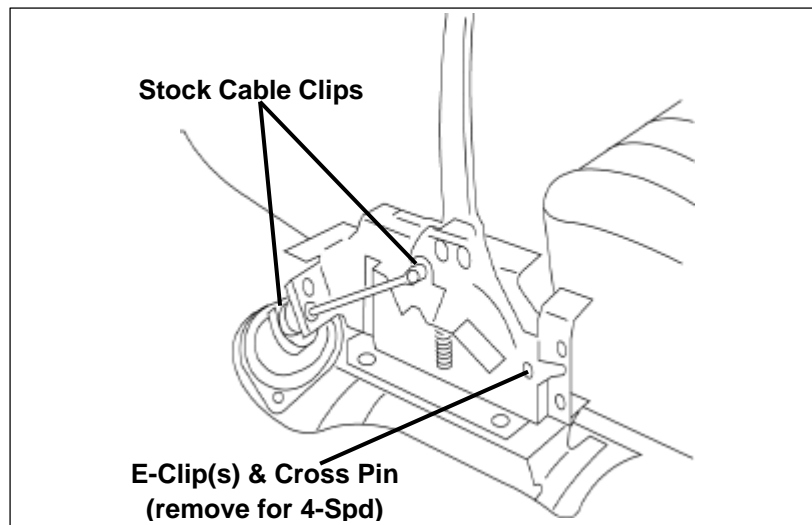

TOOL LIST

- | | | |
|---------------------------------|-------------------|-------------------------|
| (1) Floor Jack and Jack Stands | (1) 13/32" Socket | (1) Electrical Tape |
| (1) Phillips Screwdriver | (1) 7/16" Socket | (1) Pliers |
| (1) Small Phillips Screwdriver | (1) 1/2" Socket | (1) 5/16" Drill Bit |
| (1) Small Flat Head Screwdriver | (1) 1/4" Wrench | (1) Centering Drill Bit |
| (1) Ratchet or Speed Handle | (1) 1/2" Wrench | (1) 1 1/2" Hole Saw |
| (1) 13mm Socket | (1) 7/16" Wrench | (1) Electric Drill |
| (1) 3/16" Hex Key | (1) Wire Cutter | (1) Hammer |
| (1) Center Punch | (1) 3/8" Socket | (1) Torque Wrench |

CHECK LIST

- 1) Cable is securely fastened to shifter and e-clip is in place.
- 2) Shifter and brackets are securely mounted to the floorboard.
- 3) Cable hole is sealed shut.
- 4) Cable is routed clear of exhaust system and moving parts.
- 5) Shifter is adjusted properly and spring clip is in place on transmission cable swivel.
- 6) The neutral safety switch is connected and functioning to prevent engine starts in drive gears and reverse.
- 7) There is no debris or dirt in the shifter mechanism.
- 8) Indicator clearly visible.
- 9) Knob is tight on shifter handle.
- 10) Shifter locks in Park and handle must be lifted to engage Reverse.
- 11) Shifter moves smoothly and freely through all positions as described in Shifter Operation.

PARTS LIST



Bracket (1)



Lever (1)



Micro Switch (2)



5/16-18 X 1.00" (2)
M8-1.25 X 25MM (2)



1/4"-14 X 1" (4)



Cable Swivel (1)

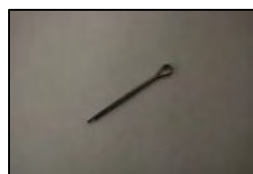

Cotter Pin (1)



Electrical Terminal (4)



6-20 X 1/2" (1)



1/4-20 X 3/4" (6)



Pan Spacer (2)



Plastic Plug (1)



Plastic Spacer (1)

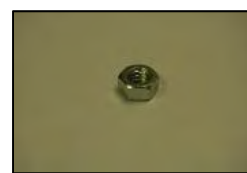

1/4-20 Hex Nut (1)



4-40 X 1-1/4" (2)



4-40 Hex Nut (2)



8-32 X 1/2" (6)



4-40 Lockwasher (4)



Indicator Light
Socket



Indicator Window
3Spd and 4Spd



Indicator Light Bulb

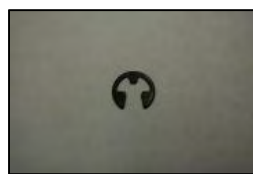

E-Clip (2)



Loctite Adhesive (1)



1/4" Washer (11)



1/4-20 X 1/2" (1)

CABLE ADJUSTMENT WARNING

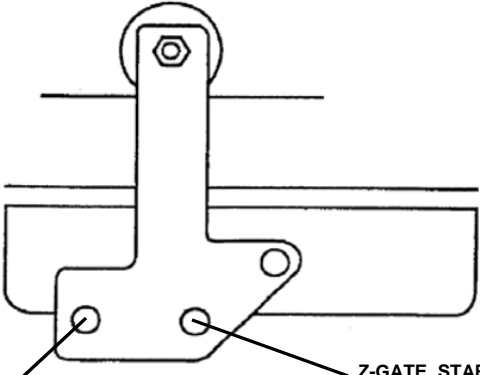

**Z-GATE, STARSHIFTER,
 QUICKSILVER #80683 W/3SPD,
 PRO RATCHET #80842 W/3SPD**

**MEGASHIFTER, UNIMATIC, PRO
 STICK, SPORT SHIFTER, HAMMER,
 QUICKSILVER #80683 W/4SPD, PRO
 RATCHET #80842 W/4SPD, STEALTH
 PRO RATCHET #81120 W/4SPD,
 BANDIT SHIFTER W/4SPD**

INSTALLATION

NOTE: Be careful. Select the correct hole for your shifter. Wrong hole **will** destroy the cable, shifter and/or transmission in **one** shift! (GM trans. only)

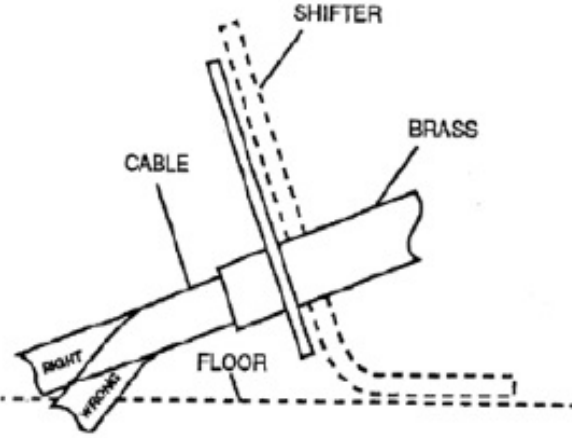

DO NOT KINK CABLE

Note: Do not kink cable anywhere along its length. If cable has a kink, it will lock up. Cable should be kept straight for 2 inches on each end where it leaves the brass. Any of the above **will** destroy the cable, shifter and/or transmission in **one** shift!

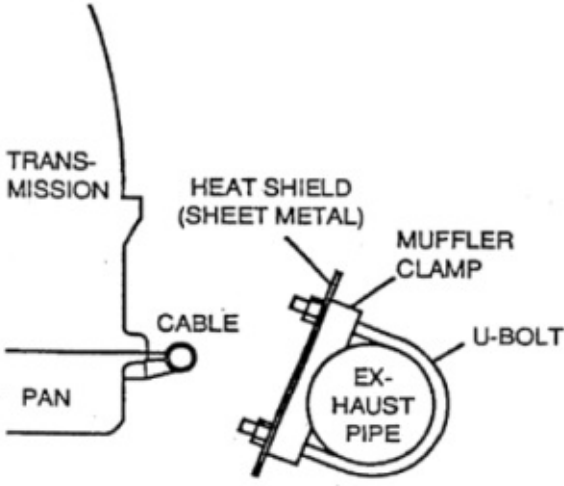

MELTED CABLES

Note: if your cable is close to your exhaust it will melt or become brittle. If this is the case, you will need to make a heat shield. **Do not wrap the cable, this retains heat.** Heat **will** destroy the cable!

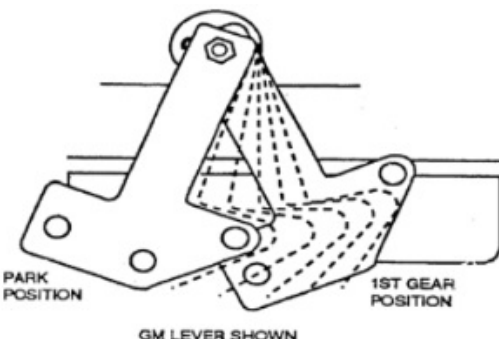

CABLE ADJUSTMENT

Note: if you don't adjust the cable correctly, you will destroy the cable, shifter and/or transmission in one shift. Put the transmission in low gear and shifter in low gear, set the swivel so it slides in and out of the correct hole freely(See installation picture). Then move the transmission and shifter to park (all the way the other way) then rotate the cable swivel until it slips in and out of the hole freely. Now go back and forth between Park and low gear and fine tune the adjustment. See instructions for further details.

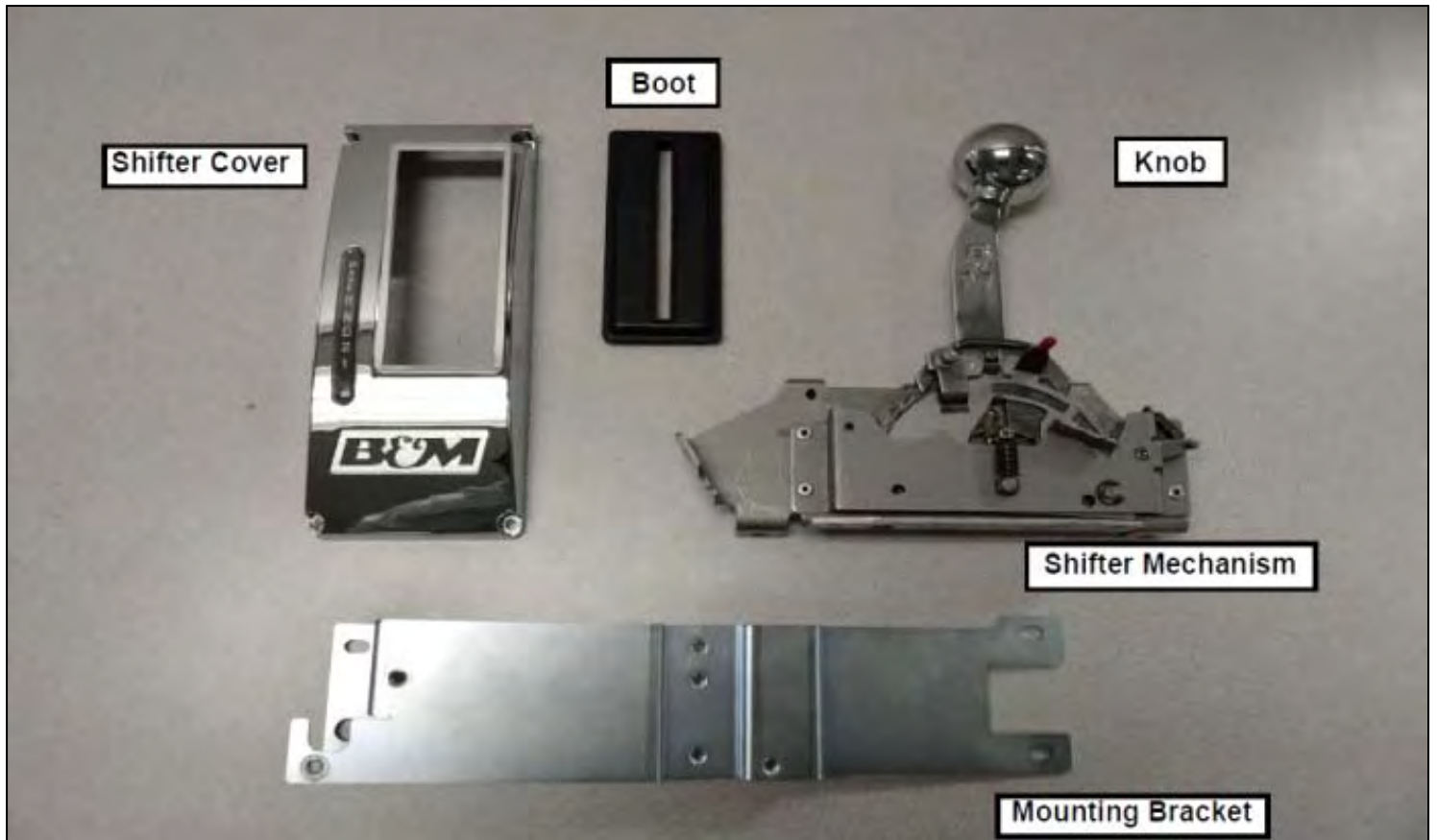

IMPORTANT: RETAIN THESE INSTRUCTIONS FOR FUTURE REFERENCE

