

BOUNTY HUNTER[®]
METAL DETECTORS

Time Ranger[™] Pro

OWNER'S MANUAL



Use 9-volt
ALKALINE batteries.

Do not use
"Heavy Duty" batteries.

Do not use
ordinary "Zinc Carbon" batteries.

TABLE OF CONTENTS

Introduction	3
Terminology	4
Assembly	5-7
Batteries	8
Quick-Start Demo	9-10
Headphones	10
Basics Of Metal Detecting	11-12
Ground Minerals	11
Trash	12
Identifying Buried Objects	12
Size and Depth of Buried Objects	12
Electromagnetic Interference (EMI)	12
Operation and Controls	13
Control Panel	14
<u>Control Knobs</u>	
Off / On / Gain	14
Disc / All Metal / Threshold	14
<u>Touchpad Controls</u>	
Menu/Ground Grab® (Computerized Ground Balancing)	15
+ and -	15
Pinpoint	15
Operating in All Metal Mode	
Ground Grab® (Computerized Ground Balancing)	16
Setting the Controls	16
Unwanted Noise	16
Sweeping the Searchcoil	16
Reading the Display	17
Target Scale	17
Operating in Discrimination Mode	
Ground Grab® (Computerized Ground Balancing)	18
Setting the Controls	18
Gain	18
Mode	18
MENU	18-20
Unwanted Noise	21
Sweeping the Searchcoil	21
Using Pinpoint	21
Reading the Display	21-23
Ground Balancing	24-26
Ground Balancing Technical Info	27
Target Display & Audio	28
Gold Prospecting	29
Relic Hunting	30
Hot Rocks	31
Electromagnetic Interference (EMI)	32-33
Search Techniques	34
Target Pinpointing	35
Device Specifications	36
Treasure Hunter's Code of Ethics	36
Warranty	38
Accessories	Back Cover

Congratulations!

Congratulations on your purchase of the Time Ranger™ Pro metal detector. The Time Ranger Pro has been custom designed to find the smallest targets, provide superior target separation and features advanced discrimination control.

Whether you use your Detector in the backyard, at the shoreline, in the mountains or fields afar, your investment will let you experience the excitement of searching for yet to be discovered treasures and give you years of outdoor enjoyment. Buried treasure can be as near as your own door step and stretch from horizon to horizon. On your own or with friends, you'll never run out of places to use your Time Ranger Pro.

This manual has been written to help you get optimal use of your detector, so we hope you will read it thoroughly before your first outing and will also refer back to this manual from time to time to reinforce features and methods as you become more proficient in the field.

Happy Hunting from Bounty Hunter!

Introduction to the Time Ranger Pro

The Time Ranger Pro is unique for its versatile function as an all-purpose treasure detector and also its high sensitivity to small gold nuggets and gold jewelry.

The controls, menu options and features include a sophisticated ground balancing system, separate control over signal gain and threshold and a unique discrimination control system. While the Time Ranger Pro makes for a highly competent coinshooting detector, its user interface and features are not specifically designed for this purpose.

The Time Ranger Pro is outfitted with an 11"DD Elliptical Biaxial Waterproof Searchcoil as standard equipment.

TERMINOLOGY

The following terms are used throughout the manual, and are standard terminology among detectorists.

RELIC

A relic is an object of interest by reason of its age or its association with the past. Many relics are made of iron, but can also be made of bronze or precious metals.

IRON

Iron is a common, low-grade metal that is an undesirable target in certain metal detecting applications. Examples of undesirable iron objects are old cans, pipes, bolts and nails.

Sometimes, the desired target is made of iron. Property markers, for instance, contain iron. Valuable relics can also be composed of iron; cannon balls, old armaments and parts of old structures and vehicles can also be composed of iron.

FERROUS

Metals which are made of, or contain, iron.

ELIMINATION

Reference to a metal being “eliminated” means that the detector will not emit a tone, nor display a Target-ID, when a metal object passes through the searchcoil’s detection field.

DISCRIMINATION

When the detector emits different tones for different types of metals, and when the detector “eliminates” certain metals, we refer to this as the detector “discriminating” among different types of metals.

Discrimination is an important feature of professional metal detectors.

Discrimination allows the user to ignore trash and otherwise undesirable objects.

PINPOINTING

Pinpointing is the process of finding the exact location of a buried object. Long-buried metals can appear exactly like the surrounding soil, and can therefore be very hard to isolate from the soil.

V.C.O.

Meaning “voltage controlled oscillator,” the V.C.O. audio method causes both the *audio pitch* and the *volume* to rise as signal strength increases. V.C.O. improves the user’s ability to interpret a target’s size and depth. Very weak signals (for small or very deeply buried objects) have the faintest volume and the lowest pitch. Larger objects, and those closer to the searchcoil, will induce a higher volume and higher pitch sound.

GROUND BALANCING

Ground Balancing is the ability of the detector to ignore, or “see through,” the earth’s naturally occurring minerals, and only sound a tone when a metal object is detected. This detector incorporates proprietary circuitry to eliminate false signals from many mineralized soils.

ASSEMBLY

Adjusting the Armrest

The armrest may be moved forward or backward by removing the single screw and nut, and then repositioning the 2-piece armrest. Users with shorter arms may find the armrest more comfortable in the forward position. In order to move the armrest backward, the plastic plug must be removed from the aluminum tube.

Armrest Strap

Some users prefer to use the strap when swinging the detector vigorously, in order to hold the detector securely against the arm.

The detector can always be used without the strap, with no compromise to detector balance and stability under most conditions.

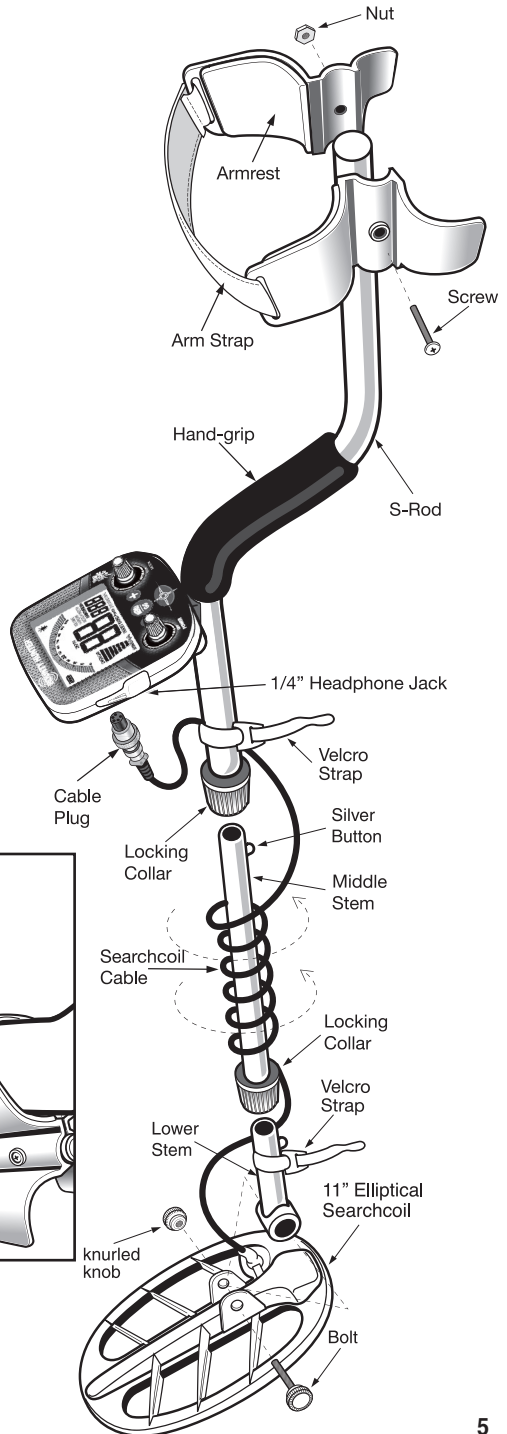
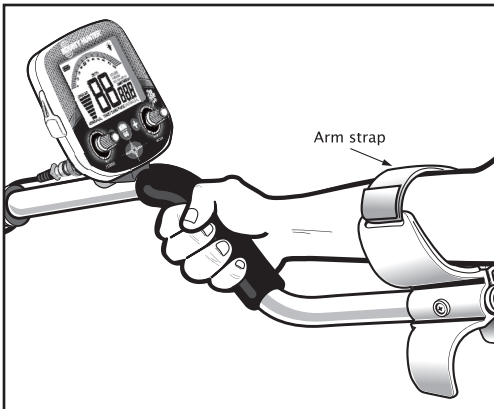

Assembly is easy and requires a #2 Phillips Screwdriver

Armrest and Control box are to be assembled FIRST.

- 1 Remove S-Rod, armrest assembly, and detector control box from packaging.
- 2 Use Philips No. 2 screwdriver and remove the screw securing the armrest. Be careful not to lose the nut installed on the opposite side of the armrest, as this can potentially fall out once the screw has been removed.
- 3 Position the armrest onto the S-Rod so that the hole for the screw is aligned to one of the three holes on the S-Rod, depending on desired armrest position.

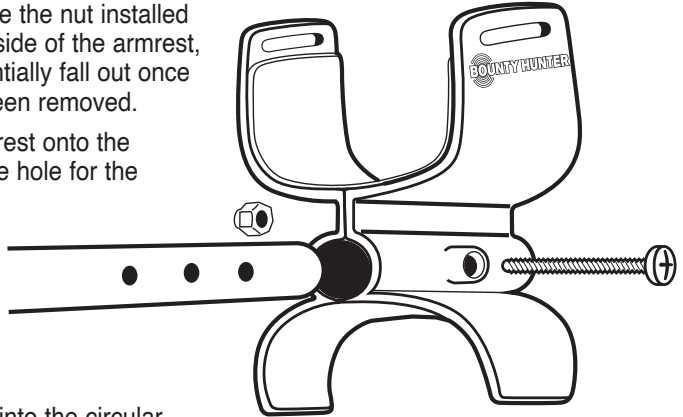

- 4 Insert the screw into the circular bezeled hole on the armrest, making sure that the screw extends through the S-Rod, exiting in to the hexagonal hole on the opposite side of the armrest.
- 5 Place the nut into the hexagonal armrest hole with the white side of the nut facing outwards.
- 6 Hold the nut in place with your thumb while tightening the screw.
- 7 Hand tighten the screw until snug.
- 8 Using a Philips No. 2 screwdriver, remove the two screws attached to the underside of the detector housing.
- 9 Position the detector housing so that the two threaded brass inserts on the housing align with the two holes on the S-Rod. These holes are located on the opposite end of the S-Rod from the armrest, near the locking collar. Ensure that the LED screen of the detector housing is facing towards the hand grip and armrest assembly.

- 10 Insert screws into the recessed holes on the S-Rod so that they extend through the rod to thread into the detector housing.
- 11 Hand tighten both screws until snug.

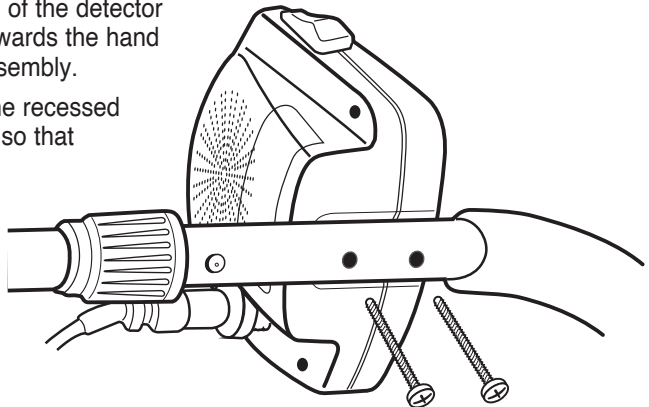

ASSEMBLY

Caution: Forcing in MIDDLE STEM with CAM LOCK raised may form a burr on cam lock. If this happens, remove burr with knife to allow insertion.

12 Position S-Rod upright.

13 Rotate the LOCKING COLLAR fully in the counterclockwise direction.

14 Insert your finger inside the tube and make sure the INTERNAL CAM LOCK is flush with the inside of the tube.

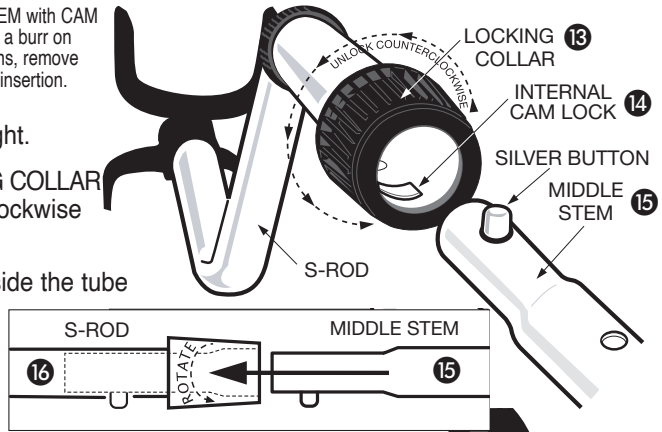

15 Insert the MIDDLE STEM into the S-ROD, with the SILVER BUTTON pointed upward

16 Rotate the MIDDLE STEM until the SILVER BUTTON snaps into the hole.

17 Twist the LOCKING COLLAR fully in the clockwise direction until it locks.

18 Repeat this process on the LOWER STEM.

19 Using the BOLT and KNURLED KNOB, attach the SEARCHCOIL to the LOWER STEM.

20 Adjust the LOWER STEM to a length that lets you maintain a comfortable upright posture, with your arm relaxed at your side, and the SEARCHCOIL parallel to the ground in front of you.

21 Wind the CABLE securely around the STEMS, leaving slack at the bottom.

22 Connect CABLE PLUG to housing. Do not twist the Cable or Plug. Turn Locking Ring only. Use minimal finger pressure to start the threads. Do not cross-thread. When the Locking Ring is fully engaged over the threaded connector, give it a firm turn to make sure it is very tight. When the Locking Ring is fully engaged over the threaded connector, it may not cover all of the threads.

23 Tighten both LOCKING COLLARS.

24 Secure cable with velcro straps as shown.

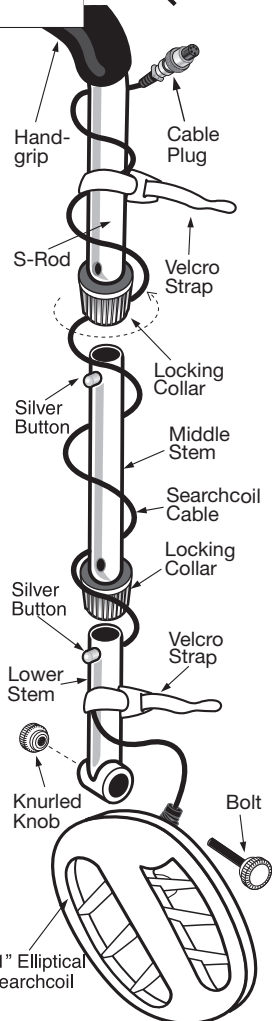

* Note: Very tall users can purchase the optional Extended Lower Stem (TUBE5X), for extended reach.

BATTERIES

A 3-segment battery indicator at the top-left of the display indicates the battery condition.

The detector requires a single 9-volt **ALKALINE** battery.

Do not use ordinary zinc carbon batteries.

Do not use “Heavy Duty” batteries.

Such low quality batteries may work in the detector but have a short life and are prone to leakage.

Rechargeable batteries can also be used.

If you wish to use rechargeable batteries, we recommend using a Nickel Metal Hydride rechargeable battery.

The battery compartment is located on the back side of the housing. Slide the battery door to the side and remove it to expose the battery compartment.

BATTERY LIFE

Expect about 15 to 20 hours of life from a 9-volt alkaline battery, without use of backlight.

Backlight increases power consumption and decreases battery life, with significant power drain at maximum brightness.

Rechargeable batteries can provide up to 8 hours of usage per charge.

SPEAKER VOLUME AND BATTERY CHARGE

You may notice the speaker volume drop when only one battery segment is illuminated.

With one segment flashing, low speaker volume will be very apparent.

BATTERY INDICATOR

The 3-segment battery indicator has 4 stages of indication.

These indications are accurate for a 9-volt alkaline battery.

Segments Illuminated

3 -segments

2 -segments

1 -segment

1 -segment flashing

Battery Voltage

more than 8.4 volts

more than 7.5 volts

more than 6.8 volts

less than 6.8 volts

After the 1st segment begins flashing, expect the detector to shut off within 10 minutes.

A rechargeable battery will usually illuminate two to three segments throughout most of its useful charge. But as soon as it drains to the 1-segment level, it will then lose its charge very rapidly.

BATTERY DISPOSAL & RECYCLING

Alkaline batteries may be disposed of in a normal waste receptacle or recycled. Non-Alkaline batteries should be recycled. In the state of California all battery types must be recycled. Please refer to local municipalities for detailed disposal and recycling requirements.

QUICK-START DEMONSTRATION

I. Supplies Needed

- a Nail
- a Zinc Penny (dated after 1982)
- a Nickel
- a Quarter

II. Position the Detector



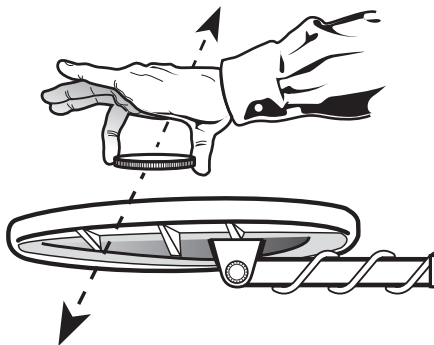

- Place the detector on a table, with the searchcoil hanging over the edge. Or better, have a friend hold the detector, with the searchcoil off the ground.
- Keep the searchcoil away from walls, floors and metal objects.
- Remove watches, rings and jewelry.
- Turn off fluorescent lights, appliances and cell phones whose electromagnetic emissions may cause interference.
- Pivot the searchcoil back.



III. Click on power with the left knob. Set the Gain at the 12:00 position for this demonstration.

IV. Click the right knob to the left to enter DISC setting.

V. Press  until "VOLUME" is highlighted on display.

- Press  or  until number on display is 12.
- Wave the nail over the searchcoil. Notice volume.
- Wave a coin over the searchcoil. Notice louder volume.
- Enter the menu/volume control again.
Use  and  to change volume as you wave nail over searchcoil. Notice the volume changing.

VI. a. Set volume at 20. Wave the nail over the searchcoil.

b. Press  until DISC is highlighted on display.

c. Press  repeatedly, while continuing to wave the nail.

The nail will be discriminated out. The Target-ID at which it is eliminated depends on the size of the nail.

VII. Wave each object over the searchcoil.

Sweep coins flat and parallel to the searchcoil. This is how you will usually find them buried.

a. Notice the 2-digit Target-IDs for each object.

b. Motion is required.

Objects must be in motion over the searchcoil to be detected in this mode.



QUICK-START DEMONSTRATION

- VIII. **Press-and-hold**  and hold the nickel over the searchcoil
- Notice that motion is not required.
A motionless object induces a hum.
 - Notice the variable pitch & volume hum.
 - Move the nickel closer to and farther away from the searchcoil.
Notice the changing “depth” values.

IX. **Click the MODE knob to the right.**

The detector is now in the ALL METAL Mode

- Keep GAIN set at the 12:00 position
- Rotate the THRESHOLD knob **slowly** from the far counterclockwise position to the full clockwise position.
Notice these attributes of the THRESHOLD control, with no metal over the searchcoil.
 - at low settings you will hear no sound
 - at mid-scale, there will be a transition point from no sound to a barely audible, choppy sound.
 - at full scale you will hear a loud, constant tone. It may also have an irregular or choppy sound, as a result of electromagnetic interference emitted from other electrical devices.

USE WITH HEADPHONES (not included)

The Time Ranger Pro is equipped with a 1/4” headphone jack. Any headphones with a 1/4” stereo plug will work; headphones with a mono plug will not work. Using headphones extends battery life, and also prevents the sounds from bothering bystanders. It also allows you to hear subtle changes in the sound more clearly, particularly if searching in a noisy location. If gold prospecting, gold nuggets are often very small, so closely monitoring changes in sound using headphones will improve your gold prospecting results. For safety reasons, do not use headphones near traffic or where other dangers are present. This device is to be used with interconnecting cables/headphone cables shorter than three meters (ten feet).

THE BASICS OF METAL DETECTING

A hobby metal detector is intended for locating buried metal objects. When searching for metals, underground or on the surface, you have the following challenges and objectives:

1. Ignoring signals caused by ground minerals.
2. Ignoring signals caused by metal objects that you do not want to find, such as pull-tabs.
3. Identifying a buried metal object before you dig it up.
4. Estimating the size and depth of objects to facilitate digging them up.
5. Eliminating the effects of electromagnetic interference from other electronic devices.

Your Time Ranger Pro metal detector is designed with these points in mind.

1. Ground Minerals

All soils contain minerals. Signals from ground minerals can interfere with the signals from metal objects you want to find. All soils differ, and can differ greatly, in the type and amount of ground minerals present. You therefore want to *calibrate* the detector to the specific ground conditions where you are hunting. The detector incorporates both automated and manual ground balancing features which will eliminate false signals from most types of soils. To maximize the detector's target identification accuracy and depth of detection, use the GROUND GRAB® COMPUTERIZED GROUND BALANCING function to calibrate the detector to the ground where you are searching. See the section on GROUND BALANCING for details.

The Basics continued on next page

2. Trash

If searching for coins, you want to ignore items like aluminum foil, nails and pull-tabs. These undesirable items are generally identified toward the lower end of the 1-99 scale. You can listen to the sounds of all objects detected, and decide on what you want to dig up. Or you can eliminate unwanted metals from detection by using the DISCRIMINATION feature.

3. Identifying Buried Objects

Different types of metals are classified along the arc at the top of the screen on a 1-99 scale from left to right. A 2-digit numerical reading is also provided in the middle of the display for more precise target identification in Discrimination Mode.

4. Size and Depth of Buried Objects

When using the detector in the motion DISC Mode, the relative depth of an object is displayed to the left of the display over the SIGNAL strength indicator. A more accurate depth reading is available using PINPOINT. Pinpoint displays estimated target depth, in inches. Pinpoint does not require the searchcoil to be in motion to detect metals. The ability to hold the searchcoil motionless over the target also aids in tracing an outline of the buried object, or in pinpointing the exact location of the object using techniques described in the pinpointing section of this manual.

5. Electromagnetic Interference (EMI)

Electromagnetic interference (EMI) can cause a metal detector to chatter spontaneously, to lose sensitivity for no apparent reason, or to cause a periodic wobbly audio sound. Common sources of EMI include power lines, electronic communication equipment such as cellphones, fluorescent lamps, military electronics such as radar, other metal detectors and computer equipment.

Your first line of defense against EMI is to reduce the Gain and/or Threshold. In areas with heavy EMI, operating at reduced sensitivity levels will result in the loss of some depth, but at least the metal detector will be usable.

See the section on ELECTROMAGNETIC INTERFERENCE for a more thorough explanation of EMI and how to manage it.

OPERATION & CONTROLS

POWERING UP

- Click the left knob clockwise to turn the detector ON.
- After clicking the knob on, continued clockwise rotation will increase the “sensitivity” in DISC Mode or the “GAIN” in ALL METAL Mode.
- We suggest keeping the GAIN below 70 until you become familiar with the detector’s operation.

HOW TO WORK THE CONTROLS

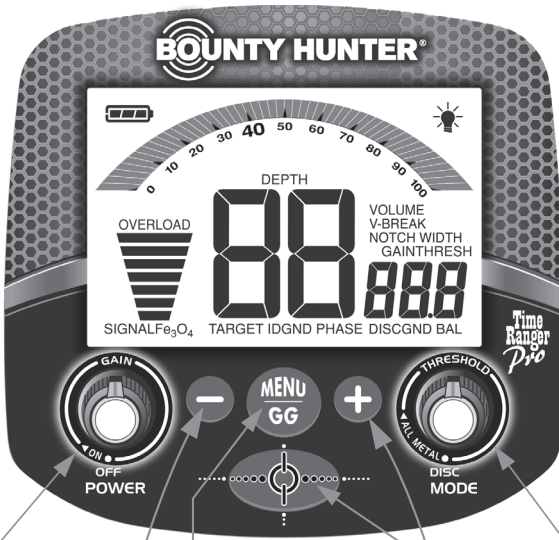

- ON/OFF/GAIN:
- Click ON/OFF
 - In DISC Mode rotate to change GAIN (sensitivity) from 1 to 100
 - In ALL METAL Mode rotate to change GAIN from 5 to 100 in steps of 5

- In DISC Mode press to cycle through menu options
- In ALL METAL Mode press-and-hold while bobbing coil to set ground balance

Press-and-hold to activate PINPOINT feature

In DISC Mode:
Change setting of active menu option

In ALL METAL Mode:
Change Ground Balance setting from 0 to 99.9

- MODE SELECTION/ THRESHOLD CONTROL
- Click left to operate in Discrimination Mode
 - Click to right to operate in ALL METAL Mode.
 - Rotate knob in ALL METAL Mode to change THRESHOLD from -40 to 40

CONTROL PANEL

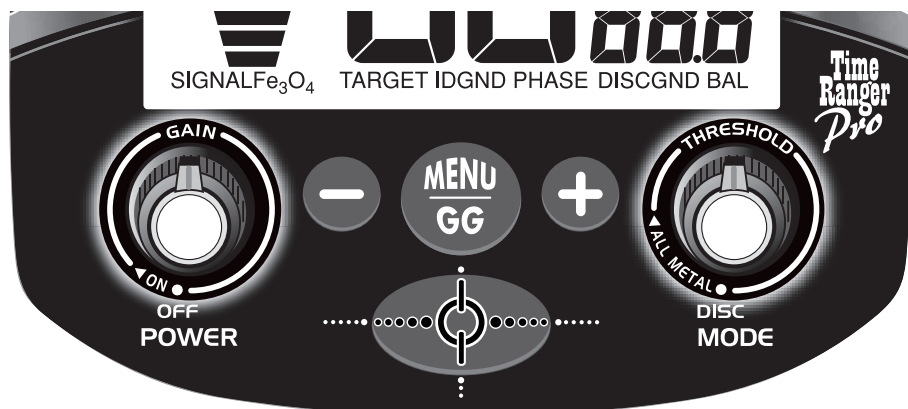

CONTROL KNOBS:

1. ON/OFF/GAIN

- Click right to turn on. Click left to turn off.
- Turning the knob clockwise increases the detector's sensitivity; the higher the sensitivity, the deeper targets will be detected, and the more likely the detector will be to detect very small targets.
- As you turn the knob, notice the GAIN value at the bottom-right of the screen displays your current sensitivity setting.

Sensitivity in DISC Mode

The left knob is labeled "GAIN" and in DISCRIMINATION Mode it alone controls the sensitivity of the detector.

GAIN in ALL METAL Mode

In All Metal Mode, GAIN increases as you rotate the knob clockwise. THRESHOLD is controlled independently using the right knob.

2. DISC / ALL METAL / THRESHOLD

- Click knob to the far-left "DISC" position and the detector enters DISCRIMINATION Mode.
- Click on clockwise to operate in ALL METAL Mode.
- In ALL METAL Mode, rotate knob to change the threshold. Threshold values range from -40 to +40.

In ALL METAL Mode, the Threshold control can be used in two ways.

Control knobs continued on next page

CONTROL PANEL

GAIN versus THRESHOLD

“Gain” increases, or multiplies, the strength of signals from buried metal objects. For maximum detection of the smallest or most deeply buried objects, increase the Gain. To minimize the weakest signals, reduce the Gain.

“Threshold” controls the detector’s audio level. Positive threshold values increases the audio response of weak target signals. Negative threshold values suppress sensitivity.

For searching at maximum sensitivity, first set the Gain at a low level. Then set threshold into the positive region, with a comfortable background-hum volume level. Then increase Gain to a comfortable level, free of chatter.

Increase Gain to a slight amount of chatter if you can tolerate the chatter while searching.

For silent searching, set threshold to a negative number, and also reduce Gain if necessary. Silent searching will result in the loss of some sensitivity.

TOUCHPAD CONTROLS

1. MENU / GG

This button has a dual function, depending on the detection mode.

- a. In DISC Mode, this control cycles through menu options. The active menu option appears in bold on the display. The menu times-out after 3 seconds.
- b. In ALL METAL Mode, press-and-hold the button to activate GROUND GRAB®.

Ground Grab® allows you to set the detector’s internal ground setting equal to the phase of the ground you are searching over. See the section on Ground Balancing for a more thorough explanation of this feature and the reason for using it.

2. ⊕ and ⊖

- a. In Discrimination Mode, ⊕ and ⊖ change the setting of the active menu option.
- b. In All Metal Mode, ⊕ and ⊖ provide a manual override to the Ground Balance Setting.

3. PINPOINT

Press-and-hold to activate the Pinpoint feature.

Pinpoint temporarily engages a no-motion detection mode. Searchcoil motion is not necessary to detect metal. Any metal within the searchcoil’s detection field will induce a sound. Pinpoint is generally used to determine the exact location of a target previously detected in Discrimination Mode.

OPERATING IN ALL METAL MODE

The All Metal Mode is more sensitive than the Discrimination Mode, and is used to find all types of metal objects in the ground. The searchcoil must be in motion for objects to be detected.

Ground Grab® COMPUTERIZED GROUND BALANCING

Naturally occurring minerals in soil look like metal to a metal detector, so you want to *cancel out* this mineral signal coming from the ground, and only detect the signal from metal objects in the ground.

So before using your detector, set it in All Metal Mode and perform the automatic ground balancing procedure. Press-and-hold the **GG® COMPUTERIZED GROUND BALANCING** button while pumping the searchcoil up and down over the ground. Release the button when the sound *evens out*. The GND BAL number on the bottom right of the screen is the detector's internal setting which cancels out the minerals in the ground. Different soils in different areas will require different GND BAL settings, so balance to ground before you search.

Refer to the Ground Balancing section of this manual for a more in-depth explanation.

Setting the Controls

As you adjust any of the controls, notice that the values on the bottom-right of the display indicate the settings of the value you are changing.

If you are new to metal detecting, start with the GAIN and THRESHOLD controls at a low enough setting that you do not hear too many unwanted sounds, like warble or a loud hum. Set the GAIN at the 12:00 position, or less. Then set the THRESHOLD to a position where you hear a very slight background hum, or if you prefer, position the knob just left of that position to a setting where the detector is silent.

Unwanted Noise

Read the section on Electromagnetic Interference.

The Time Ranger Pro is a highly sensitive device.

It is intended for use outdoors. Indoor operation will subject it to interference from a wide variety of devices in the home or office.

Sweeping the Searchcoil

As you sweep the searchcoil over the ground, try to keep the searchcoil parallel to the ground.

Avoid lifting the searchcoil at the end of your sweeps.

Operating in All Metal Mode continued on next page

OPERATING IN ALL METAL MODE

Reading the Display

Most gold prospecting and relic hunting is done by ear. Listen for the louder sounds, riding on top of the constant background hum.

As you sweep the searchcoil, notice the Fe_3O_4 (iron oxide) scale to the left of the display.

This indicates the *amount* of ground mineralization.

Most black sand is made of magnetite.

Gold nuggets are often found in concentrated black sand deposits.

For the best depth detection in highly mineralized soils, use the All Metal Mode.

For the most accurate Fe_3O_4 reading, pump the searchcoil over the ground.

While sweeping the searchcoil, also notice the **GND PHASE** value in the middle of the screen.

GND PHASE is the ground phase; this indicates the *type* of minerals in the soil.

Within an area, the ground phase may change.

After ground balancing, periodically compare GND PHASE to GND BAL. If these two numbers differ by a great deal, you may want to ground balance the detector again.

When not adjusting the knobs, the **GND BAL** setting will always appear on the bottom-right of the display.

GND BAL is the detector's internal ground balance setting. The detector's default ground balance setting is 82.9, which is the best starting point for achieving the correct setting.

After you perform the Ground Grab® procedure, the GND BAL number will change to match your soil.

You can change the current GND BAL setting by pressing the **+** or **-** buttons.

See section on Ground Balancing for a more detailed explanation.

Experienced users often prefer to adjust the ground balance to get a weak audible response when lowering the searchcoil to the ground. This is called *adjusting for positive response* and is achieved by increasing the GND BAL number with the **+** key.

Target Scale

The arc across the top classifies metal objects.

Each time a target is detected, three segments will illuminate above the arc.

The segments will remain illuminated for three seconds.

This indication shows the approximate classification of the buried metal object.

See the section on Target Display for a more detailed explanation.

Iron is on the left. U.S. dimes and quarters are to the far right.

When relic hunting, any Target-ID greater than 40 is a potential non-ferrous relic.

In an air test, gold indicates right of center – the larger the gold piece, the farther to the right.

In the ground, the ID of gold may jump around with each pass of the searchcoil.

If searching in All Metal Mode, you may want to switch back into Discrimination Mode, after finding a target. Review the 2-digit Target-ID provided in the Discrimination Mode for a more precise target identification.

OPERATING IN DISCRIMINATION MODE

Discrimination is used to eliminate trash metal objects (e.g. nails, foil, pull-tabs) from detection. The searchcoil must be in motion to detect metal. The Discrimination Mode is less sensitive to small and deep objects than the All Metal Mode.

Ground Grab® COMPUTERIZED GROUND BALANCING

This feature is not available in Discrimination Mode.

Your best results will be achieved by first performing the COMPUTERIZED GROUND BALANCING procedure in All Metal Mode.

The ground balance setting achieved using COMPUTERIZED GROUND BALANCING will carry over into this mode.

Setting the Controls

As you adjust any of the controls, notice that the values on the bottom-right of the display indicate the settings of the value you are changing.

GAIN

If you are new to metal detecting, start with the GAIN at a low enough setting that you do not hear any sounds when the searchcoil is sweeping across the ground, with no metal present.

Start with GAIN at the 12:00 position, or less.

In this mode, Gain refers to the detector's sensitivity. The higher the setting, the deeper objects can be found, and the more sensitive the detector is to very small metal objects.

MODE

The right knob is not used in the Discrimination Mode.





Click the right knob 100% counterclockwise.

If you turn the knob to the right, you will leave Discrimination Mode, entering All Metal Mode.

MENU



The Menu is located on the right side of the screen. During Discrimination operation the Menu is inactive; during All Metal operation, Menu is not available. Use  to select a Menu option.

Use  and  to modify the setting of the selected Menu option.

 and  change the menu settings. When the menu is not visible,  and  change the DISC setting; it is not necessary to access the menu to change DISC during operation.

Menu options are:

Backlight

Available setting from 0 to 5. This option controls the brightness of the display backlight. When the backlight is on,  is illuminated. In daylight, the backlight can be turned on but will not be visible, draining the batteries. So be sure  is not illuminated if backlight illumination is not required.

Operating in Discrimination Mode continued on next page

OPERATING IN DISCRIMINATION MODE

Volume

Use **⊖** or **⊕** to adjust the volume setting when the VOLUME menu option is highlighted. The default volume setting is 7.

Press **⊕** to increase speaker volume. Maximum volume is at setting 20.

Press **⊖** to lower speaker volume. The minimum volume setting is 0, no sound.

With volume set to 0, the Target-ID and Depth Bar Graph will function as normal, but the detector will not emit a sound when targets are detected.

The overload volume signal will always sound off in the event of signal overload, even with the volume set to 0.

Because the Time Ranger Pro is so sensitive to even the smallest iron targets, the detector incorporates **FeTone™**, Adjustable Iron Audio, a feature to reduce the volume of iron targets to minimize user fatigue.

Volume settings 10 - 20 are available to control the volume level of iron targets.

As you increase volume from 10 to 20, iron-volume changes from silent to maximum. Note that, depending on the V-BREAK® setting, iron targets may induce V.C.O. tones; in this case, the V.C.O. tones in the iron range (ID 1 - 39) will also have the same reduced volume.

At each of the 10 - 20 volume settings, nonferrous target response is maximum volume.

Volume control applies only to motion target detection.

Volume changes do not affect Pinpoint volume.

Table describes ferrous and nonferrous volume at each setting



Volume			Volume		
Setting	Nonferrous	Ferrous	Setting	Nonferrous	Ferrous
1	1	1	11	10	1
2	2	2	12	10	2
3	3	3	13	10	3
4	4	4	14	10	4
5	5	5	15	10	5
6	6	6	16	10	6
7	7	7	17	10	7
8	8	8	18	10	8
9	9	9	19	10	9
10	10	0	20	10	10

Setting Memory:

When detector is powered OFF settings are saved, except for the ground setting and backlight level.

When detector powers ON, ground is preset to 82.9 and backlight is always OFF.

How to preset to factory default settings (if desired).

- Power detector OFF.
- Set right knob to DISC.
- Press-and-hold .
- Turn ON while holding .
- The menu options will flash.
- Release ; detector turns on and all settings are restored to the factory defaults.

OPERATING IN DISCRIMINATION MODE

V-Break (Change audio for certain targets)

V-Break is a feature that allows the user to change the audio response of certain targets. V-Break allows the user to program the detector so that any target with an ID in the range of 0 - 80 can induce a LOW tone.

Examples:

The user sets V-Break to a desired setting (e.g. 42).

Every target with ID less than or equal to 42 induces a low tone.

The audio response of targets with IDs greater than 42 are not changed. V-Break can be set only for Target-IDs that have not previously been rejected using the discrimination or notch functions.

Notch Width

As you press **+** or **-** when adjusting the Notch Width setting, the blank area you see across the Conductivity Arc represents targets that will not be detected. This blank area is the “notch-window.”

Notch Width allows you to set the size (or width) of this notch-window, which can be used to “notch out” or “notch in” targets from detection; the maximum width of the notch-window is 20.

Notch

After setting the width of the notch-window, it can be moved around using NOTCH. The setting you adjust corresponds to the left-most edge of the notch-window.

Disc

Available settings from 0-80. All targets with ID's less than or equal to the Disc setting are eliminated from detection. For example, if Disc is set to 39, all targets with an ID of 39 or less will not be detected. By design, the detector does not allow highly conductive targets (like silver) to be discriminated out.

Press **+** to eliminate unwanted metals from detection.

Each time you press **+** the Disc value at the bottom-right of the display will increment by one.

Press-and-hold **+** to increase the Discrimination level rapidly.

See the Target Identification section of the manual for a detailed description of this function.

Sections of the arc with no indication represent metals completely eliminated from detection.

Press **-** to detect metals which were previously eliminated from detection

Operating in Discrimination Mode continued on next page

OPERATING IN DISCRIMINATION MODE

Unwanted Noise

Read the section on Electromagnetic Interference.

This is a highly sensitive device.

It is intended for use outdoors. Indoor operation will subject it to electrical interference from a wide variety of devices in the home or office.

In Discrimination Mode, when you sweep the coil over the ground it will usually be quieter than when holding the detector still.

Sweeping the Searchcoil

As you sweep the searchcoil over the ground, try to keep the coil parallel to the ground.

Avoid lifting the searchcoil at the end of your sweeps.

Using PINPOINT

Press-and-Hold the Pinpoint button to narrow down the location of a buried metal object.

Pinpoint does not require the searchcoil to be in motion.

A motionless searchcoil held over a metal object will induce a hum; volume and pitch of the hum increase with target strength.

The approximate target depth, in inches, will be indicated in the center of the screen.

The depth scale is calibrated to coin-sized objects.

Relative depth is indicated for larger or smaller objects.

Upon releasing the button, you will return to a motion detection mode.

If you keep the Pinpoint button depressed for a long time, the audio tone may begin to drift.

If you plan to search like this, release and re-press the button periodically to avoid drift. Drift may result in a loudening sound or a reduced sensitivity with no sound.

See the manual section on Target Pinpointing for how to *narrow down* a target's location.

This technique is indispensable as long-buried metals can look exactly like the surrounding soil to the naked eye. If you are not adept at pinpointing, digging up and retrieving a small metal object can be very frustrating. So learn how to *narrow-it-down*.

READING THE DISPLAY

TARGET-ID

Each time you pass the searchcoil over a metal object, a 2-digit value will appear in the center of the display. See the manual section on Target Identification for a better understanding of these values.

Three segments will simultaneously appear above the arc at the top of the screen.

This represents the same Target Identification, but displayed graphically on the scale.

Target Scale

This display works as in the All Metal Mode.

The arc across the top classifies metal objects.

Each time a target is detected three segments will illuminate above the arc.

The segments will remain illuminated for three seconds.

This indication shows the approximate classification of the buried metal object.

See the section on Target Display for a more detailed explanation.

Iron is on the left. U.S. dimes and quarters are to the far right.

In an air test, gold indicates right of center – the larger the gold piece, the farther to the right.

In the ground, the ID of gold may jump around with each pass of the coil

OPERATING IN DISCRIMINATION MODE

SIGNAL

Each time a target is detected, bars will illuminate on the bottom left showing the strength of the target's signal.

If all 7 bars illuminate, the target signal is strong.

This may be a large metal object.

Or it may be a coin-sized metal object close to the surface.

If only a few bars illuminate, the target signal is weak.

This may be a deeply buried object, even a big one.

Or it may be a very, very small metal object, close to the surface.

The depth of a coin-sized object can be confirmed using Pinpoint.

In Discrimination Mode, when menu is not displayed, pressing **+** or **-** will change the discrimination setting.

As the level of discrimination changes, the target segments along the arc on the screen will be displayed in one of two states:

1. Blank (no segments displayed)
2. Black (segments are solid black)

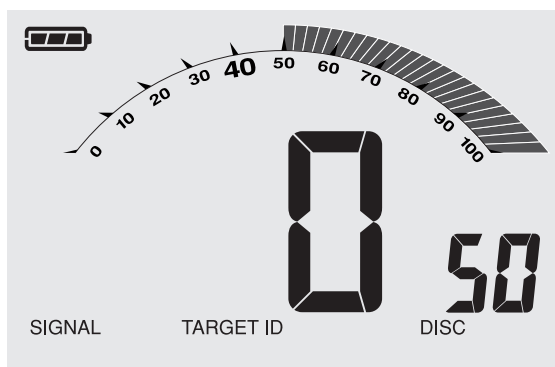

The segments along the arc will remain illuminated in this state as you are pressing **+** or **-**. This displays your chosen target discrimination parameter.

At any time during operation, you can view the discrimination settings in one of two ways:

1. On the bottom-right of the screen the DISC value is always illuminated. All Target-IDs less than or equal to the value displayed will not be detected.
2. Whenever you press **+** or **-**, the arc will illuminate and show your current detection parameters. The first press of **+** or **-** will change the discrimination level by one value.

Discrimination Control continued on next page

OPERATING IN DISCRIMINATION MODE

When a target is detected, the rectangular segments representing the target category are illuminated.

Here is an example of one possible discrimination setting:

DISC = 20

V-BREAK = 50

NOTCH not set

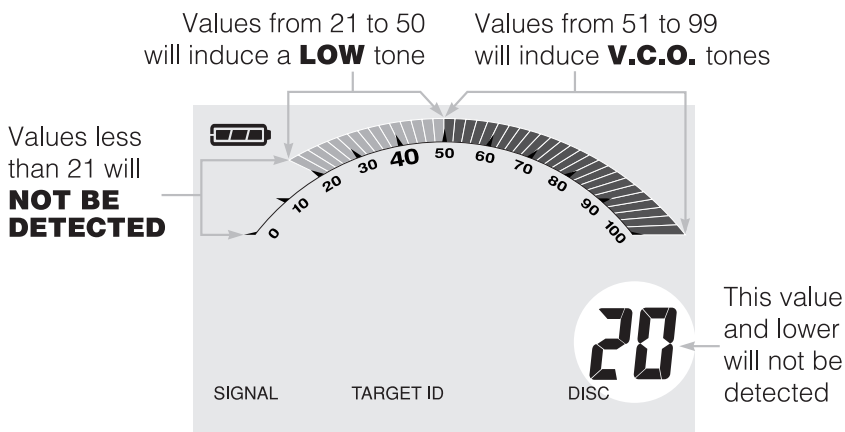

The discrimination interface for the Time Ranger Pro was designed for multi-purpose metal detecting.

Suggestion: Try changing the settings, watch the screen, and pass objects over the searchcoil at each setting. It will quickly become obvious how these controls work.

GROUND BALANCING

What is Ground Balancing? Why do I need to Ground Balance?

All soils contain minerals. Signals from ground minerals are often tens or hundreds of times stronger than a buried metal object. The magnetism of iron minerals, found in nearly all soils, causes one type of interfering signal. Dissolved mineral salts, found in some soils are electrically conductive, causing another type of interfering signal. The mathematical term for describing these differences is *Phase*. *Phase* varies with the types of minerals present in the soil.

Ground Balancing is the process by which the metal detector cancels the unwanted signals coming from the ground minerals while still detecting the signals from buried metal objects. This is accomplished by matching the detector's ground balance setting to the phase of the ground signal.

When the detector is calibrated to the soil, the result will be deeper target detection, quieter operation, and more accurate target identification.

How to Ground Balance your detector:

Ground Balancing procedure with the Ground Grab® COMPUTERIZED GROUND BALANCING (GG) touchpad.

1. Turn the detector on and set GAIN at the 12:00 position.
2. Click on the right knob to the ALL METAL Mode.
3. Rotate the THRESHOLD control knob to the point where you hear a slight background hum.
4. Sweep searchcoil across the ground to find a clear patch of ground with no metal present.
5. Press and hold the Ground Grab® COMPUTERIZED GROUND BALANCING (GG) touch pad, and pump searchcoil over the clean ground. *See illustration above.*

Pump searchcoil from within 1" of ground to 6"- 8" above ground.

6. When the GND PHASE *settles down* to only 1 or 2 numbers in variation, release the GND GRAB button while still pumping the searchcoil. Note that the audio response to the ground changed and "Evened Out" when you released the button. Also note that the GND BAL value changed. After balancing, you can hunt in ALL METAL... or return to Disc Mode.

The most accurate GND PHASE value is the value displayed when "pumping" the searchcoil over the ground in an area free of metal.

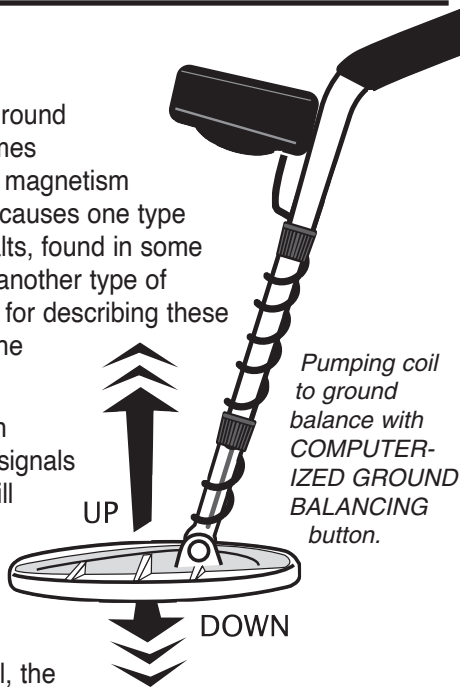

GROUND BALANCING

Understanding ground conditions assists the user in setting up the machine, knowing when to readjust ground balance, and in understanding the responses of the machine while searching.

This detector displays two kinds of ground data:

1. The *type* of mineralization (which affects where the ground phase should be set). This is **GND PHASE**
2. The *amount* of mineralization (the greater the amount of mineralization, the greater the loss of detection depth & ID accuracy; this loss is more pronounced in Discrimination Mode). This is **Fe₂O₃**.

The goal of ground balancing is to equate the GND BAL number to the PHASE number.

PHASE is the measurement of the ground.

GND BAL is the detector's internal setting which calibrates the detector to the ground's phase.

Notice that the GND BAL number is three digits, with a decimal point. PHASE has only two digits.

GND BAL is a higher resolution number, so may differ a bit from PHASE in a perfectly balanced scenario.

After pumping and releasing Ground Grab® COMPUTERIZED GROUND BALANCING (GG), the exact measurement of the ground will be transferred to the GND BAL setting.

The two-digit PHASE number displayed on the screen indicates the *type* of ground mineralization.

Some typical ground mineralization types are:

- 0 – 10 Wet salt and alkali
- 5 – 25 Metallic iron. Very few soils in this range. You are probably over metal.
- 26–39 Very few soils in this range -- occasionally some saltwater beaches
- 40–75 Red, yellow and brown iron-bearing clay minerals
- 75–95 Magnetite and other black iron minerals
- 96–99 Values over 95 are generally an indication of a searchcoil or electronics defect or out-of-calibration condition.

GROUND BALANCING

The goal of the Ground Balancing procedure is to eliminate the sound as the searchcoil is being pumped over the ground. In some soils, the sound is not completely eliminated.

After balancing to ground with Ground Grab® COMPUTERIZED GROUND BALANCING (GG) some users may want to further adjust the ground balance setting manually.

To manually adjust ground balance:

1. Operate in ALL METAL Mode.
2. Pump searchcoil up and down over the ground as in the COMPUTERIZED GROUND BALANCING procedure.
3. Press ⊕ or ⊖ while pumping

If the ground balance adjustment is incorrect, there will be a difference in the sound as the searchcoil is either moving toward or away from the ground. It sounds like you are either ***pulling the sound out of the ground***, or ***pushing the sound into the ground***.

- If the sound is louder as you raise the searchcoil, increase the ground balance setting.

- If the sound is louder as you lower the searchcoil, reduce the ground balance setting.

NOTE: Experienced users often prefer to adjust the ground balance to get a weak but audible response when lowering the searchcoil. This is called *adjusting for positive response*.

POSITIVE AND NEGATIVE RESPONSE

The purpose of ground balancing is to adjust the metal detector to ignore ground minerals. If the setting is incorrect, ground minerals will give either a *positive* or a *negative* response, depending on which direction the adjustment is off.

Positive Response

If the GND BAL setting is too high a number, the response of minerals will be *positive*. This means that when the searchcoil is lowered to the ground in PinPoint or All Metal Mode, the sound will get louder as the searchcoil approaches the ground. The sound will grow quieter as the searchcoil is raised. What, if anything, you will hear in Discrimination Mode depends on the discrimination setting.

When searching in an All Metal Mode, if ground balance is properly set to cancel the ground, and you sweep over a *positive hot rock*, the rock will give a “zip” sound similar to that of a metal object.

Negative Response

If the GND BAL setting is too low a number, the response of minerals will be *negative*. When the searchcoil is lowered to the ground in PinPoint or All Metal Mode, the machine will be silent. The machine will sound off as the searchcoil is lifted away from the ground. What, if anything, you hear in Discrimination Mode depends on the Discrimination setting.

When searching in All Metal Mode a *negative hot rock* will produce a “boing” sound after passing over it, making it difficult to know where it is located. It will not have the sound and “feel” of a metal object.

GROUND BALANCING -Technical Info

Fe O BARGRAPH

The Fe O 7-segment bar graph indicates the *amount* of ground mineralization, independent of type, expressed as an equivalent volume concentration of magnetite (Fe O). It updates every second. It is sensitive to motion and will give the most accurate readings if you *pump* the searchcoil up and down several times over the ground. The presence of metal or “hot rocks” will cause the readings to be inaccurate. If you stop moving the searchcoil, the bar graph will go blank.

INDICATION	RELATIVE MINERALIZATION	% Fe O <small>3 4</small>	SUSCEPTIBILITY
7 Bars	High	over 1	over 2,500
2 to 6 Bars	Medium	.026 - 1.0	61 - 2,500
1 Bar	Very Low	0.006 - .025	15 - 60
None	--	less than .006	less than 15

Magnetic susceptibility is expressed in micro-cgs units. In a saltwater environment in the absence of iron minerals, the bar graph indicates relative electrical conductivity.

In soils with greater than 10,000 micro-cgs units of magnetic susceptibility, the signal from the soil may saturate, or overload, the circuitry. This will not harm the detector but the machine will not be usable in that condition. The solution is to hold the searchcoil several inches above the soil surface so it is not “seeing as much dirt.” By listening and watching you will know how high you need to hold the searchcoil in order to avoid overload.

The highest magnetic susceptibilities are usually found in soils developed over igneous rocks, in alluvial black sand streaks on beaches and in red clay soils of humid climates.

The lowest magnetic susceptibilities are usually found in white beach sands of tropical and subtropical regions, and soils developed over limestone.

TARGET DISPLAY and AUDIO

SIGNAL Indicator

The lower-left bargraph designates SIGNAL strength only when operating in Discrimination Mode.

The signal strength indicator at the bottom-left of the screen indicates how large or close the buried metal target is.

If all bars are illuminated, the target is large or close to the searchcoil.

If one or two bars are illuminated, the target is far away or small, or both.

DEPTH Indicator

A target's location and size can be verified using the PINPOINT control.

Press PinPoint to temporarily detect metal without searchcoil motion, and a monotone hum.

While holding the PinPoint button, the DEPTH indicator will appear. The number beneath DEPTH represents the distance of the object, in inches, from the searchcoil. The Depth scale is calibrated to coin-sized objects. For objects other than a coin, the numeric value is a relative measure of the target's depth.

AUDIO FEEDBACK

When a target is detected, the Time Ranger Pro will respond with two types of sound:

1. V.C.O. (Voltage Controlled Oscillator): an audio response with variable pitch and volume.
2. A LOW tone beep.

In Discrimination Mode, targets which fall into the zone along the arc whose segments are *shaded* will be identified with a LOW tone beep and those whose segments are *solid* with V.C.O.

As the user sets the discrimination level with the **+** and **-** buttons, he is determining which targets will be eliminated.

All targets' audio responses in All Metal Mode will be V.C.O.

V.C.O. (Voltage Controlled Oscillator) is an audio response which provides a good feel for the target.

The stronger the target signal, the higher the volume and the higher the audio pitch. Very weak signals will have the faintest volume and lowest pitch.

For this reason, the use of headphones is always recommended for detecting the smaller and deeper targets.

2-DIGIT TARGET INDICATOR

In Discrimination Mode the 2-digit target indicator, in the middle of the screen, provides a specific target value to help identify buried targets more accurately. With practice in the field, you will learn to associate target values with the probable identification of buried objects. The target value can vary each time the searchcoil passes over the target, depending upon the orientation of the object and its distance from the searchcoil.

As a starting point, refer to the table below.

TARGET Readout

The table below lists some common approximate target values. With experience in the field, you will recognize many types of metal objects by their numeric value.

As a general reference, targets fall into the following ranges:

- 1 - 39: iron
- 42 - 48: foil and small gold nuggets
- 54 - 57: gold nuggets, gold rings or targets containing mostly gold
- 87 - 89: clad coins or coins of recent vintage
- 82 - 83: copper coins
- 93 - 99: larger silver coins

Note: There are a wide variety of metals and no target can be identified for certain until unearthed. This table is for general reference only.

GOLD PROSPECTING

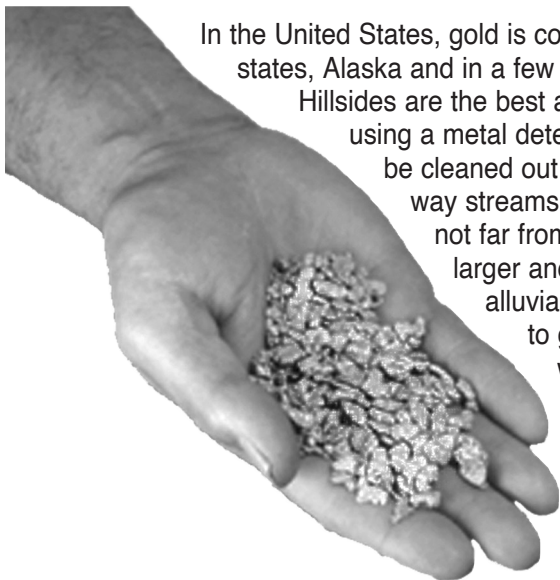

In the United States, gold is commonly found in the western states, Alaska and in a few localities in the Appalachians. Hillsides are the best areas for gold prospecting using a metal detector, because hillsides cannot be cleaned out by panning and dredging the way streams can. Also, gold on hillsides, not far from its source vein, tends to be larger and more readily detected, than alluvial (placer) gold, which tends to get pounded to pieces and worn away as it rolls along the streambed. Even in a good gold producing area, detectorists often spend an entire day without finding any gold, but will dig bits and pieces of other metal

such as birdshot, bullets and rusted tin cans, etc. Another nuisance can be "Hot Rocks" - rocks containing concentrations of iron oxides that sound like metal when passed over with the detector. Discrimination is usually ineffective because the loss of sensitivity resulting from discrimination is enough to make the little nuggets invisible.

Because most gold nuggets are tiny, and are usually found in soil which is high in iron oxide minerals, serious gold prospecting requires a detector with high sensitivity and true ground balanced All Metal operation. Set the detector with the sensitivity high enough to hear some noise from ground minerals, and *learn the language* of the sounds you hear. Headphones are recommended unless there are safety issues (for instance rattlesnakes). Move the searchcoil slowly and deliberately, carefully controlling its height above the ground to minimize noise from iron minerals in the soil. If you hear ground noise, the Ground Balance setting could be off, so perform the ground balancing procedure again. The ground geology typically associated with the presence of gold will tend to change over very short distances.

The Fe_3O_4 bar graph indicates the amount of iron mineralization in the soil. In most gold fields, especially alluvial deposits, gold tends to be associated with iron minerals, especially magnetite *black sand*. Therefore, to maximize gold recovery, concentrate on areas where the bar graph indicates higher amounts of iron mineralization.

RELIC HUNTING

Searching for coins and relics often means detecting in heavy concentrations of iron and dealing with crop-stubble or forest ground clutter.

The Time Ranger Pro can handle the toughest ground mineralization, capable of ground balancing all the way to salt. With its fast retune speed and 11"DD, the Time Ranger Pro creates superb target separation with impressive depth. The 11"DD Elliptical Searchcoil is ideal for working between brush, rocks and debris commonly found at old abandoned sites. An expanded 40-point iron ID range helps differentiate between larger iron objects and smaller nails and pieces. With FeTone™ adjustable iron audio, the volume level of ferrous targets can be lowered separate from the volume level of non-ferrous targets, allowing desired targets to be heard much easier.

The fine-tune adjustable Notch Width can be used to target specific unwanted items, such as shell casings or bottle caps, and the enhanced V-Break®, our Variable Tone Breakpoint, allows the user to further customize the detector's settings to get unique audio on specific Target-ID ranges. Combined, the Notch Width and V-Break features create endless variations for fine tuning the detector to meet exact hunting needs.

An adjustable back-light on the display allows for hunting in low-light conditions.



HOT ROCKS

A *hot rock* is a rock which causes the metal detector to sound off because the rock contains iron minerals. They come in two basic types.

Negative hot rocks (also called cold rocks) are usually magnetite or contain magnetite, and give a negative response because their ground balance value is a higher number than the soil they are found in. They tend to be dark in color, usually black, and usually heavy. In some cases they will have rust stains. They are usually attracted to a magnet, and for this reason gold prospectors always carry a magnet -- the ultimate ferrous/nonferrous discriminator. In All Metal Mode, negative hot rocks produce a *boing* sound rather than the *zip* sound of a metallic target; recognize the difference and you will learn to ignore them. As the searchcoil passes over a hot rock, this *boing* sound, or negative response, is quite distinctive. To hear this response, you must be properly Ground Balanced and in All Metal Mode with an audible threshold hum. First, as the center of the searchcoil passes over the negative hot rock, the detector will go quiet; the threshold hum momentarily silences. Then, passing beyond the negative hot rock, you hear the *boing* sound. As you pass the searchcoil back and forth over a negative hot rock, it will be impossible to pinpoint and will seem as if it *moves around*.

Positive hot rocks are iron-bearing rocks which have been oxidized by natural weathering processes so that their GND BAL value is a number lower than the soil they are found in. They are often small, right on the surface, sound just like a gold nugget, and are common in many gold prospecting areas. They are usually, but not always, drawn to a magnet. They are most often reddish in color but are often black, brown, or yellow. On relic hunting sites, red clay bricks and rocks which have lined a fireplace or a campfire will often be *hot rocks*. The discriminator will usually eliminate them without difficulty if widely scattered, but if there is a large concentration of them, the discriminator may not quiet them all. In that case, you can revert to the rule of thumb -- "don't dig non-repeatable signals."

Remember to always carry a magnet to help discriminate gold from hot rocks and iron.

- Gold will not be attracted to a magnet.
- Pieces of iron will always be attracted to a magnet.
- Negative hot rocks will almost always be attracted to a magnet.
- Positive hot rocks will usually be attracted to a magnet.

ELECTROMAGNETIC INTERFERENCE (EMI)

You are likely to encounter electromagnetic interference (EMI) when using your Time Ranger Pro metal detector. It is important that you recognize EMI and take appropriate measures to deal with it. This will prevent you from giving up on a worthwhile search site, or from returning a properly functioning detector for repair.

Symptoms of Electromagnetic Interference

EMI can cause a metal detector to *chatter* spontaneously, to lose sensitivity for no apparent reason, or to cause a periodic *wobbly* audio sound. What you hear will depend on what operating mode you are using, the detector's settings, and the source of the electrical interference. The most common manifestation is spontaneous chatter. All metal detectors are susceptible to EMI, but they vary in what kinds of interference affect them. In a given environment some metal detectors may be affected by EMI whereas others may not.

Common sources of Electromagnetic Interference

Common sources of EMI include: overhead electric power lines, underground power lines, other metal detectors, telephone lines carrying electronic data, computer systems, electric fences, old CRT-based televisions, **cell phones**, CB and emergency communication radios, thunderstorms, fluorescent lights, metal vapor lamps, military aircraft with electronic warfare countermeasures turned on, electric motors, VLF military communications systems and automobile ignition systems. At home, in a store, or in an urban environment, there may be several different sources of interference present simultaneously.

All metal detectors generate a certain amount of internal electronic noise. The Time Ranger Pro is specifically designed to enable you to *work into the noise*. Experienced users, striving for maximum depth, often adjust the machine to search with a constant audible background sound, and then listen through that noise for the sound of real targets.

Stricter regulations in recent years have cut down on interference from electric light dimmers and auto ignition systems. However there has also been a proliferation of VLF-UHF wireless communication systems (cell phones, Bluetooth, Wi-Fi, etc.), which often affect metal detectors. Overall, the potential for electromagnetic interference is greater than it was just a few years ago.

Modern high-end metal detectors are a lot more sensitive than older units; this also increases your detector's vulnerability to EMI beyond what you may be accustomed to with an older detector. Metal detectors are by their nature designed to detect magnetic fields, and electric current always produces magnetic fields.

Coping with Electromagnetic Interference

*The primary reason metal detectors provide a sensitivity (gain and/or threshold) control, is so that users can reduce sensitivity in order to eliminate response to electrical interference. Some users are reluctant to reduce sensitivity out of fear of losing depth. At reduced sensitivity settings, you may lose some depth, but at least you can still search. **The Gain and Threshold knobs control the sensitivity and are your first line of defense against EMI.** The Threshold control only applies to the All Metal Mode.*

ELECTRICAL INTERFERENCE (EMI)

EMI is usually easier to control in the All Metals Mode than in the Discrimination Mode.

On the Time Ranger Pro, setting the discrimination level between 20 and 30 will usually reduce interference. In the Discrimination Mode, the detector may chatter if the searchcoil is not in motion, but once you start sweeping it over the ground, the signal from the ground will usually suppress the EMI chatter, except for an occasional pop or click which will not sound like a real target.

If you are conducting an indoor demonstration, you may find that changing the orientation of the searchcoil will reduce the pickup of EMI.

If you carry a cell phone or other high-tech electronic equipment while metal detecting and you encounter EMI, try turning the device off and see if that solves the problem. Turn such devices completely off, not just into standby mode.

When working near overhead power lines, you may get the best results right under the power line and the worst results when standing at a 30° to 45° angle to the power line.

Many sources of EMI are intermittent. You may find that an area which is difficult to search at one time of day may be easier after 5 PM, or on weekends. Power lines are usually quietest late at night, and on weekend mornings.

Small searchcoils usually pick up less EMI than larger searchcoils. On a site with severe electrical interference, a small searchcoil is often a better choice than a large one.

Distinguishing Electromagnetic Interference from other problems

EMI will often vary as you walk around from place to place, and it will also vary with changes in the orientation of the searchcoil. This is almost never the case if there is a functional problem with the metal detector itself.

The most common cause of a noisy metal detector, where the problem is not EMI, is a defective searchcoil. If striking the searchcoil with your hand causes the noise to start or stop, the problem could be a defective searchcoil. Also, a defective searchcoil often causes noise of a more intermittent nature than electrical interference.

The second most common cause is a loose searchcoil connector. The noise from a loose connector will usually be very erratic or intermittent in nature. Try unplugging the searchcoil and then reconnecting it to ensure the connector is firmly installed.

If you use a searchcoil cover, dirt or water can accumulate inside it, and movement of those materials can cause false signals while sweeping the searchcoil. Searchcoil covers must be periodically removed and cleaned.

SEARCH TECHNIQUES

Target Verification

After detecting a target, do the following:

1. Walk around the target in a circle.
2. While circling the target, continue sweeping the searchcoil across the target.
3. Sweep once every 30° or 40° of the circle.

If the tone does not change and the Target-ID value is consistent as you circle the target, you can be highly confident of the target's identification.

If the tone or Target-ID changes as you circle the target, you may have multiple targets or an irregularly shaped object.

If the tone completely disappears at different angles, the target may be trash or a low-value metal.

If you are new to the hobby, dig all targets. With practice in the field, you will soon be able to correlate audible and visual target feedback with certain types of metal objects.

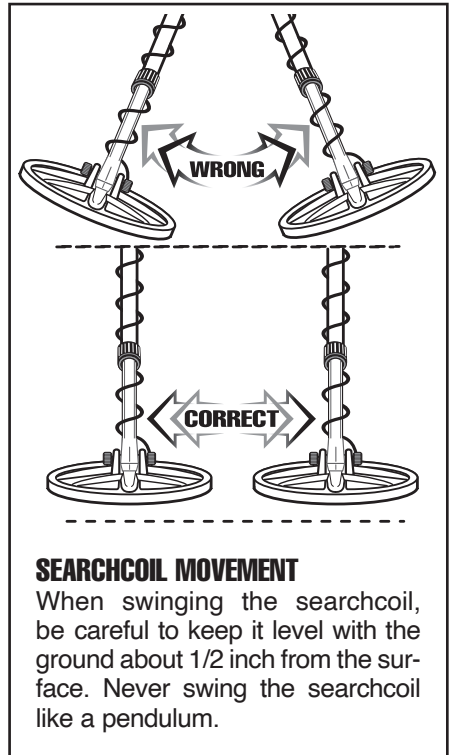

Pinpointing in Discrimination Mode:

1. Sweep over target in narrowing side-to-side pattern.
2. Take visual note of spot on ground where “beep” occurs.
3. Step 90° to the side of the target.
4. Sweep searchcoil over same area, at 90° to 1st sweep pattern.
5. This pinpoints the target location with an “X.”

TARGET PINPOINTING

After you have identified a target using Discrimination Mode, press-and-hold the PINPOINT button to identify the target's exact location. This technique can yield more information about the target's shape and size and also find its exact location to facilitate extraction.

Pinpoint as follows:

1. Position the searchcoil just barely off the ground, and to the side of the target.
2. Now move the searchcoil slowly across the target; you can locate it by the sound. The target is located directly under where the sound is loudest.

Narrow It Down:

1. To narrow the response further, position the center of the searchcoil near the center of the response pattern, but not directly over the center.
2. Release the PINPOINT button.
3. Press-and-hold PINPOINT button again.
4. Repeat this narrowing procedure to narrow the field of detection further.

Note: Depth indication is less accurate after narrowing.

SEARCHCOIL DRIFT

If you plan to use the PINPOINT Mode for continuous searching, realize that drift will occur over time, causing the detector to gain or lose sensitivity. Periodic retuning of the detector is required to minimize drift; release and press PINPOINT again to retune.



DEVICE SPECIFICATIONS

Mechanical: S-rod with electronics housing on rod, 3-piece breakdown construction, nonmetallic telescoping lower rod, adjustable position Armrest

Weight: 2.87 lbs. (1.30 kg) with battery installed

Standard searchcoil: 11"DD Elliptical Waterproof Searchcoil

Batteries: Single 9 volt rectangular alkaline

Operating principle: VLF induction balance

Operating frequency: 19.2 kHz, crystal controlled

Reactive overload: 10,000 micro-cgs (with standard searchcoil)

Resistive overload: 1,200 micro-cgs (with standard searchcoil)

Ground balance range: From ferrite to salt water inclusive

Discrimination ground suppression: Combination of 2nd and 3rd order methods

Target-ID ground suppression: 3rd order

Battery life: 15+ hours on good quality alkaline (less using backlight)

Operating temp range: 14 to 122 degrees F (-10 to +50 C)

Operating humidity range: 0 - 90% noncondensing

TREASURE HUNTER'S CODE OF ETHICS

- Always check Federal, State, County and local laws before searching.
- Respect private property and do not enter private property without the owner's permission.
- Take care to refill all holes and leave no damage.
- Remove and dispose of any and all trash and litter found.
- Appreciate and protect our inheritance of natural resources, wildlife and private property.
- Act as an ambassador for the hobby; use thoughtfulness, consideration and courtesy at all times.
- Never destroy historical or archaeological treasures.
- All treasure hunters may be judged by the example you set; always conduct yourself with courtesy and consideration of others.

According to FCC part 15.21 Changes or Modifications made to this device not expressly approved by the party responsible for compliance could void the users authority to operate this equipment.

This device complies with FCC Part 15 Subpart B Section 15.109 Class B.

This equipment has been tested and found to comply with the limits for a Class B digital device, pursuant to Part 15 of the FCC Rules. These limits are designed to provide reasonable protection against harmful interference in a residential installation. This equipment generates, uses and can radiate radio frequency energy and, if not installed and used in accordance with the instructions, may cause harmful interference to radio communications. However, there is no guarantee that interference will not occur in a particular installation. If this equipment does cause harmful interference to radio or television reception, which can be determined by turning the equipment off and on, the user is encouraged to try to correct the interference by one or more of the following measures:

- Reorient or relocate the receiving antenna.
- Increase the separation between the equipment and receiver.
- Connect the equipment into an outlet on a circuit different from that to which the receiver is connected.
- Consult the dealer or an experienced radio/TV technician for help

This device complies with Industry Canada license-exempt RSS standard(s). Operation is subject to the following two conditions: (1) this device may not cause interference, and (2) this device must accept any interference, including interference that may cause undesired operation of the device.

This radio transmitter has been approved by Industry Canada to operate with the antenna types listed below with the maximum permissible gain and required antenna impedance for each antenna type indicated. Antenna types not included in this list, having a gain greater than the maximum gain indicated for that type, are strictly prohibited for use with this device.

Antennas:

1. 11" DD Coil, Part Number 11COIL-PROT

Under Industry Canada regulations, this radio transmitter may only operate using an antenna of a type and maximum (or lesser) gain approved for the transmitter by Industry Canada. To reduce potential radio interference to other users, the antenna type and its gain should be so chosen that the equivalent isotropically radiated power (e.i.r.p.) is not more than that necessary for successful communication.

Le présent appareil est conforme aux CNR d'Industrie Canada applicables aux appareils radio exempts de licence. L'exploitation est autorisée aux deux conditions suivantes : (1) l'appareil ne doit pas produire de brouillage, et (2) l'utilisateur de l'appareil doit accepter tout brouillage radioélectrique subi, même si le brouillage est susceptible d'en compromettre le fonctionnement.

Le présent émetteur radio a été approuvé par Industrie Canada pour fonctionner avec les types d'antenne énumérés ci-dessous et ayant un gain admissible maximal et l'impédance requise pour chaque type d'antenne. Les types d'antenne non inclus dans cette liste, ou dont le gain est supérieur au gain maximal indiqué, sont strictement interdits pour l'exploitation de l'émetteur.

Conformément à la réglementation d'Industrie Canada, le présent émetteur radio peut fonctionner avec une antenne d'un type et d'un gain maximal (ou inférieur) approuvé pour l'émetteur par Industrie Canada. Dans le but de réduire les risques de brouillage radioélectrique à l'intention des autres utilisateurs, il faut choisir le type d'antenne et son gain de sorte que la puissance isotrope rayonnée équivalente (p.i.r.e.) ne dépasse pas l'intensité nécessaire à l'établissement d'une communication satisfaisante.

5-YEAR LIMITED WARRANTY

The ***Time Ranger Pro*** metal detector is warranted against defects in materials and workmanship under normal use for 5 years from the date of purchase to the original owner.

Damage due to neglect, accidental damage, or misuse of this product is not covered under this Warranty. Decisions regarding abuse or misuse of the detector are made solely at the discretion of the manufacturer.

Proof of Purchase is required to make a claim under this warranty.

Liability under this Warranty is limited to replacing or repairing, at our option, the metal detector returned, shipping cost prepaid to First Texas Products. Shipping cost to First Texas Products is the responsibility of the consumer.

To return your detector for service, please first contact First Texas Products for a Return Authorization (RA) Number. Reference the RA number on your package and return the detector within 15 days of calling to:

**First Texas Products L.L.C.
1120 Alza Drive
El Paso, TX 79907
Phone: 915-633-8354**

NOTICE TO CUSTOMERS OUTSIDE THE U.S.A.

This Warranty may vary in other countries;
check with your distributor for details.
Warranty does not cover shipping costs.

Warranty coverage does not include the cost of transporting the detector back to an owner who is located outside of the United States of America.



Copyright© 2020 by First Texas Products, L.L.C.

All rights reserved, including the right to reproduce this book, or parts thereof, in any form.

Published by First Texas Products, L.L.C.

Bounty Hunter® is a registered trademark of First Texas Products, L.L.C.

www.detecting.com

1120 Alza Drive, El Paso, TX 79907 • (915) 633-8354



ACCESSORIES

Bounty Hunter® Carry Bag

Rugged double-stitched construction. – CBAG2

Bounty Hunter® Pouch & Digger Combo

Pouch with 2 large pockets & 9" heavy duty digging tool. – TP-KIT-W

Tek-Point

Pinpoints the exact location of buried metal objects. Pulse induction with 3 sensitive levels, audio signal indicator and vibrator. No assembly required, runs on (2) AA-Volt Battery. Waterproof submersible up to 10 feet. – TEK-POINT

Bounty Hunter® Sand Scoop

Large scoop with filtering holes. Made of strong plastic. – SAND SCOOPBH

Searchcoil Covers

Specially made to protect your coil from abrasion and damage. 11"DD Coil Cover – COVER-11DD

Lesche Knife

Made from high quality heat-treated tempered steel. The ultimate digging tool. Comes with a durable sheath. 12" in length with a 7" serrated blade – LESCHE KNIFE

The Digger

Tough caron stell blade 7.5" x 2" (total length 12"). Double edge blade with 32 sharp cutting teeth. Comes with tough cordura carry sheat for belt mount use. – DIGGER

Rain Cover

Specially designed to protect your detector from dirt and water. – RAINCOV-GB

Bounty Hunter® Baseball Cap

One size fits all, with Bounty Hunter® logo. – BHCAP

Bounty Hunter® T-Shirt

100% cotton with Bounty Hunter® Logo. Sizes: S, M, LG, XL & XXL – BHTSHIRT

Gold Prospecting Kits

Items Included:

	Gold Kit PART NUMBER: GOLDKIT1	Deluxe Kit PART NUMBER: GOLDKIT2	Hardrock Kit PART NUMBER: GOLDKIT3
10 ½" Gold Pan	x	x	x
14" Gold Pan	x	x	x
Classifier		x	x
2 - Shatterproof Vials	x	x	x
Snuffer Bottle	x	x	x
Black Sand Magnet		x	x
Treasure Scoop		x	x
Tweezers			x
Magnifier			x
Crevice Tool			x
Rock Pick			x
Instruction Booklet	x	x	x
Backpack		x	x



FOR COMPLETE DETAILS VISIT WWW.DETECTING.COM • 1-800-413-4131