

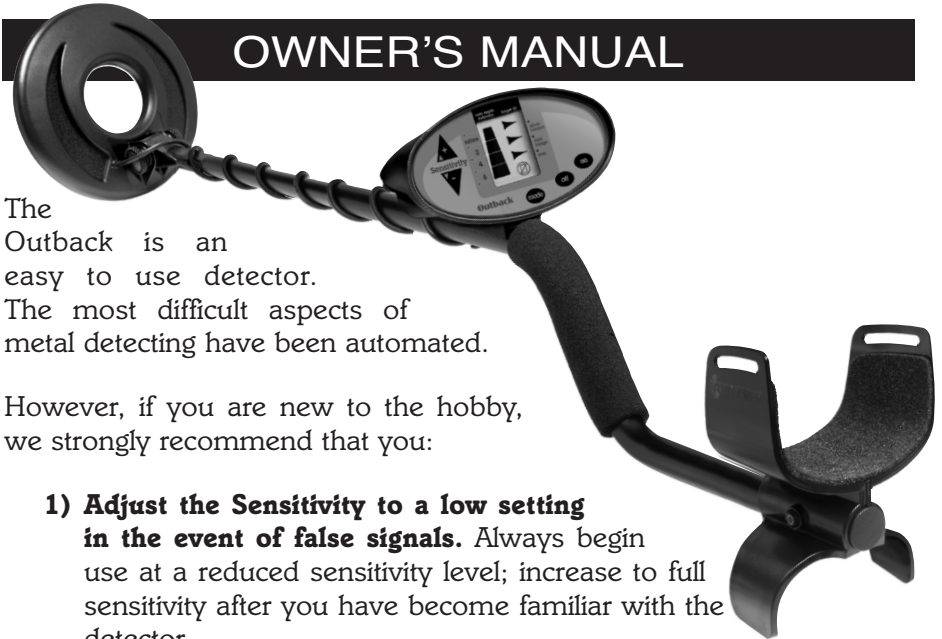

the Outback™

OWNER'S MANUAL



The Outback is an easy to use detector. The most difficult aspects of metal detecting have been automated.

However, if you are new to the hobby, we strongly recommend that you:

- 1) Adjust the Sensitivity to a low setting in the event of false signals.** Always begin use at a reduced sensitivity level; increase to full sensitivity after you have become familiar with the detector.
- 2) Do not use indoors.** This detector is for outdoor use only. Many household appliances emit electromagnetic energy, which can interfere with the detector. If conducting an indoor demonstration, turn the sensitivity down and keep the searchcoil away from appliances such as computers, televisions and microwave ovens. If your detector beeps erratically, turn off appliances and lights (especially those with dimmer switches).

Also keep the searchcoil away from objects containing metal, such as floors and walls.

- 3) Read this manual.** Most importantly, review the **Quick-Start Demo** (p.7) and **Basic Operation** (pp. 9-12).
- 4) Use 9-volt ALKALINE batteries only.** Do not use Heavy Duty Batteries.

TABLE OF CONTENTS

Terminology	3
Assembly	4-5
Batteries	6
Quick-Start Demo	7-8
Basic Operation	
Powering Up	9
The Display	9-10
Mode Control (discrimination)	11
Discrimination Settings	12
Headphones	12
Audio Target Identification	13
Sensitivity Adjustment	14
In The Field Techniques	15-17
Troubleshooting	18
Treasure Hunter's Code of Ethics	19
Warranty	19
Accessories	Back Cover

TERMINOLOGY

The following terms are used throughout the manual, and are standard terminology among detectorists.

ELIMINATION

Reference to a metal being "eliminated" means that the detector will not emit a tone, nor light up an indicator, when a specified object passes through the coil's detection field.

DISCRIMINATION

When the detector emits different tones for different types of metals, and when the detector "eliminates" certain metals, we refer to this as the detector "discriminating" among different types of metals. Discrimination is an important feature of professional metal detectors. Discrimination allows the user to ignore trash and otherwise undesirable objects.

RELIC

A relic is an object of interest by reason of its age or its association with the past. Many relics are made of iron, but can also be made of bronze or precious metals.

IRON

Iron is a common, low-grade metal that is an undesirable target in certain metal detecting applications. Examples of undesirable iron objects are old cans, pipes, bolts, and nails.

Sometimes, the desired target is made of iron. Property markers, for instance, contain iron. Valuable relics can also be composed of iron; cannon balls, old armaments, and parts of old structures and vehicles can also be composed of iron.

FERROUS

Metals which are made of, or contain, iron.

PINPOINTING

Pinpointing is the process of finding the exact location of a buried object. Long-buried metals can appear exactly like the surrounding soil, and can therefore be very hard to isolate from the soil.

PULL-TABS

Discarded pull-tabs from beverage containers are the most bothersome trash items for treasure hunters. They come in many different shapes and sizes. Most pull-tabs can be eliminated with the Mode Control, but some other valuable objects can have a magnetic signature similar to pull-tabs, and will also be eliminated when discriminating out pull-tabs.

GROUND BALANCE

Ground Balancing is the ability of the detector to ignore, or "see through," the earth's naturally occurring minerals, and only sound a tone when a metal object is detected.

ASSEMBLY

Armrest Strap

(optional accessory)

The strap is available for purchase as a separate accessory. Some users prefer to use the strap when swing the detector vigorously, in order to hold the detector secure against the arm.

The detector can also be used without the strap, with no compromise to detector balance and stability under most conditions.

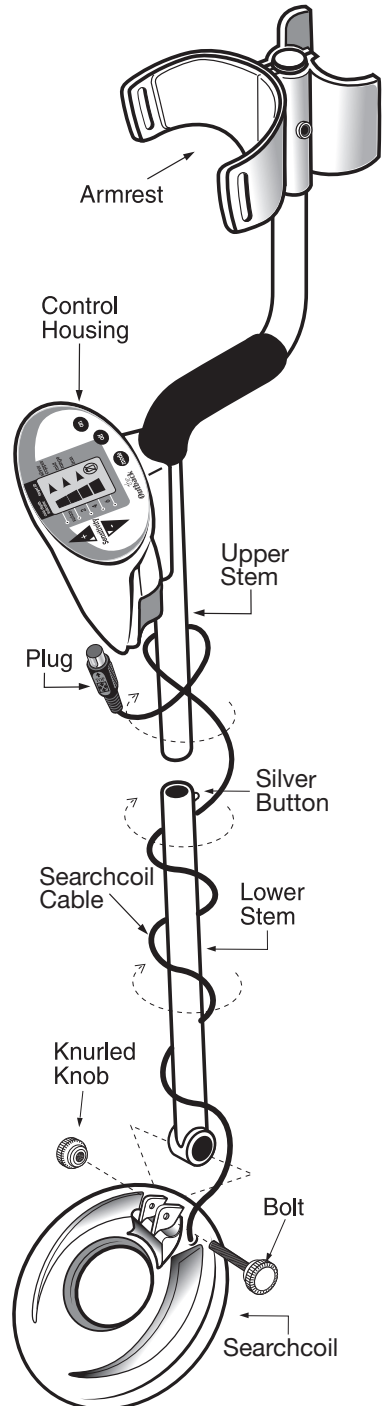
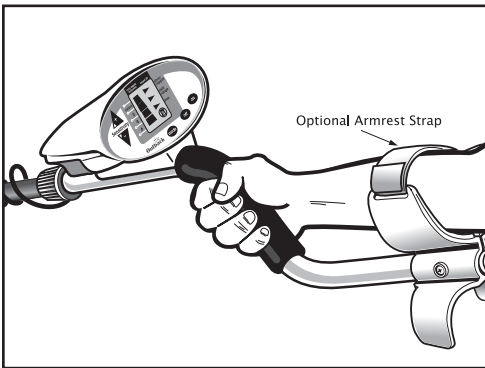

ASSEMBLY

Assembling your Outback Metal Detector is easy and requires no tools. Just follow these steps:

1 Using the supplied bolt and knurled knob, attach the searchcoil to the lower stem.

2 Press the button on the upper end of the lower stem and slide the lower stem into the upper stem.

Adjust the stem to a length that lets you maintain a comfortable upright posture, with your arm relaxed at your side. Maintain the searchcoil about 1 inch above the ground as you sweep.

3 Wind the searchcoil cable around the stem. Leave enough slack in the cable to let you adjust the coil when you are hunting on uneven ground. Then tighten the knob at the end of the searchcoil.

Note: To adjust the coil, simply loosen the knob.

4 Insert the coil's plug into the matching connector on the control housing. Be sure the holes and pins line up correctly.

Caution: Do not force the plug in. Excess force will cause damage. To disconnect the cable, pull on the plug. **Do not pull on the cable.**

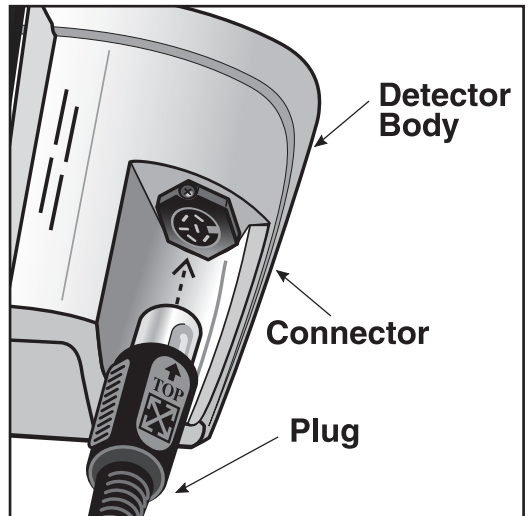
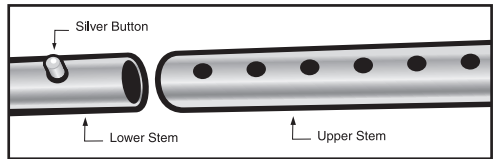
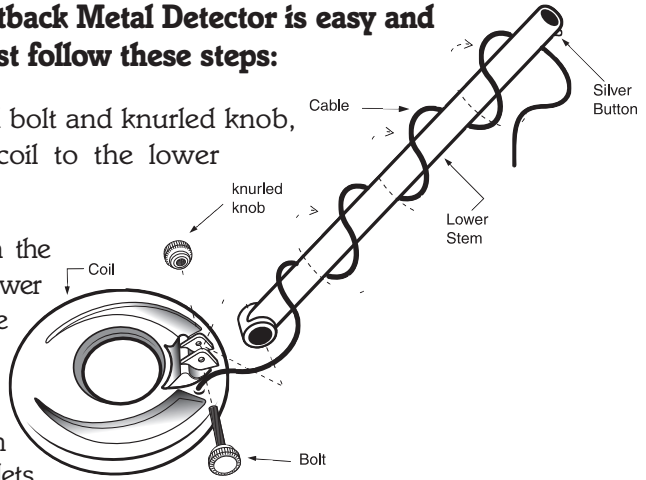

BATTERIES

Use **ALKALINE** batteries only.

To install the batteries:

- 1 Remove the battery cover by disengaging the clip at the back.
- 2 Align the polarity of the batteries correctly, with the positive "+" toward the coil plug connection, as indicated by the + and - indicators on the housing.
- 3 Insert (2) 9-Volt **ALKALINE** batteries, with the contacts pointed inward, and press down on the back of the batteries to snap them into place.

Some brands of batteries will require moderate force to clear the retaining tabs.

- 4 Replace the battery door.

The Low Battery Indicator will come on and stay on if the batteries need to be replaced.

Most metal detector problems are due to improperly installed batteries, or the use of non-alkaline or discharged batteries. **If the detector does not turn on, please check the batteries.**

DO NOT MIX OLD AND NEW BATTERIES

BATTERY DISPOSAL & RECYCLING

Alkaline batteries may be disposed of in a normal waste receptacle or recycled. Non-Alkaline batteries should be recycled. In the state of California all battery types must be recycled. Please refer to local municipalities for detailed disposal and recycling requirements.

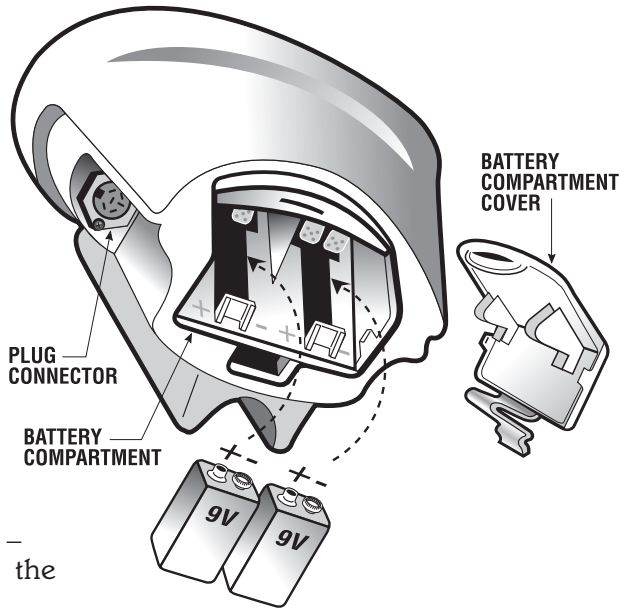

QUICK-START DEMONSTRATION

I. Supplies Needed

- A Nail
- A Quarter
- A Pull-Tab from a beverage can
- A Zinc Penny (dated after 1982)

II. Position the Detector

- Place the detector on a table, with the searchcoil hanging over the edge. (or better, have a friend hold the detector, with the coil off the ground)
- Keep the searchcoil away from walls, floors, and metal objects.
- Remove watches, rings and other jewelry or metal objects from hands and wrists.
- Turn off appliances or lights that cause electromagnetic interference.
- Pivot searchcoil back toward the detector body.

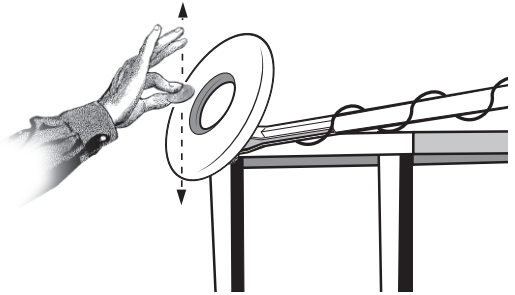

III. Power Up

Press the ON touchpad.
The detector will beep twice and the full sensitivity setting will be indicated on the left of the display.

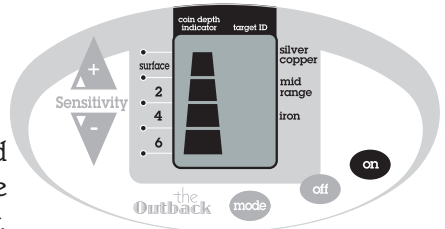

IV. Wave each Object over the Searchcoil

- Notice a different tone for each object.
 - Low Tone:** Nail
 - Medium Tone:** Pull-tab & Zinc Penny
 - High Tone:** Quarter
- Motion is required. Objects must be in motion over the searchcoil to be detected.

V. Press the MODE touchpad(*)

The detector will beep twice and the sensitivity setting will flash on the left side of the display.

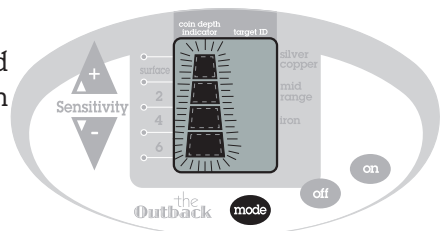

Quick-Start Demo continued on next page

QUICK-START DEMONSTRATION (continued)

VI. Press the MODE touchpad again.(*)

- A flashing indicator will point toward IRON.
- The flashing indicator tells us that Iron has been eliminated from detection.

VII. Wave the Nail over the Searchcoil

- The Nail will not be detected.
- The Nail has been "Discriminated Out."

VIII. Wave the Quarter, Penny, and Pull-Tab over the Searchcoil

These non-ferrous objects will be detected with their own distinctive tones.

IX. Press the MODE touchpad again.(*)

- The detector will beep twice and the sensitivity setting will flash on the left side of the display.
- Notice the flashing arrow pointing toward Iron.
The flashing arrow indicates that this target category is currently "Discriminated Out."

X. Press the MODE touchpad again.(*)

The flashing arrow will now point toward MID-RANGE.

XI. Wave all objects over the Searchcoil

The Pull-Tab and Zinc Penny will not be detected.
The other objects will be detected with their own distinctive tones.

XII. Toggle modes by pressing the MODE touchpad again.(*)

- Press once to see the current discrimination status of the detector (Mid-Range Eliminated).
- Then press again to toggle to the third discrimination setting.
 - Iron is eliminated.
 - Mid-Range Metals are eliminated.
 - Only high-tone metals like silver and copper will be detected.

(*Note: The mode status will flash for 10 seconds. After 10 seconds, mode status will time-out and stop flashing.

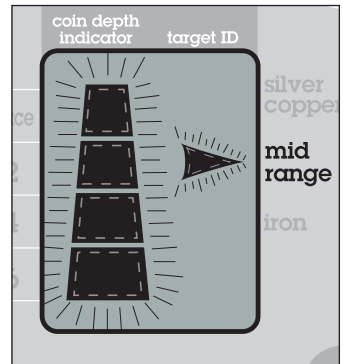
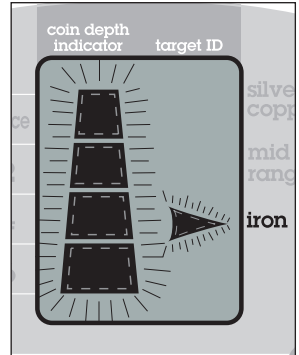

BASIC OPERATION

POWERING UP

Press the ON touchpad.

All display indicators will illuminate momentarily.

The 4-segment pyramid-shaped Sensitivity Indicator will illuminate on the left side of the display. The 4-segment pyramid indicates that the detector is at full sensitivity.

When an object is detected, the object will be identified by a tone, a display indicator, and a depth indication.

A two-minute “warm-up” is required before the detector reaches full sensitivity.

UNDERSTANDING THE DISPLAY

The LEFT SIDE of the display has a dual purpose:

1 SENSITIVITY LEVEL

Upon power-up, and after pressing either the up- or down-sensitivity pads, the pyramid-shaped display indicates the detector's **sensitivity level**.

The sensitivity level can be changed using the up- and down-pads.

At maximum sensitivity, the unit can detect a coin-sized metal object buried about 6" beneath the surface; larger objects can be detected much deeper.

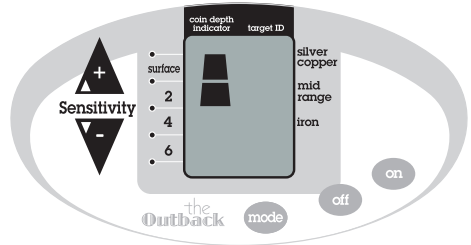

2 DEPTH INDICATION

After detecting an object, the pyramid-shaped display indicates the approximate **depth** of buried, coin-sized objects.

Objects at or near the surface will illuminate the single segment at the top of the scale.

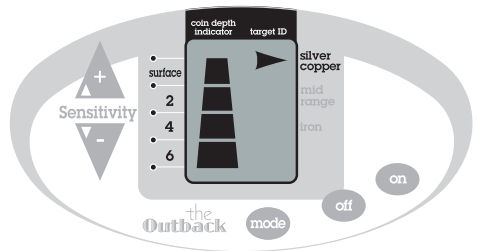

More deeply buried objects will illuminate more segments, indicating depths of 2, 4, or 6 inches, as identified to the left of the display.

The depth indicator is not accurate for large, or irregularly shaped, objects. However, the scale will provide relative depth indications for larger objects; a given object will induce deeper readings the farther it is from the searchcoil.

BASIC OPERATION (continued)

The RIGHT SIDE of the display classifies objects into three categories.

Silver/Copper: _____

Objects composed of silver and copper will illuminate this arrow. Buried and heavily oxidized metal objects, such as old tin cans, can also fall into this category. Larger aluminum objects, like beverage cans, will sometimes fall into this category.

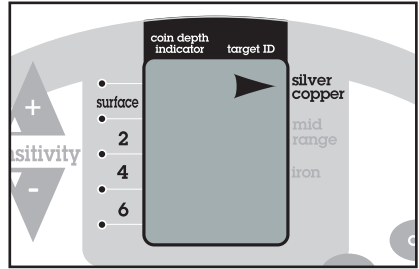

Mid-Range: _____

Mid-range objects cover a large variety of metals. Among them are: pull-tabs from beverage containers, nickels, medium-sized gold objects, some types of aluminum, and zinc.

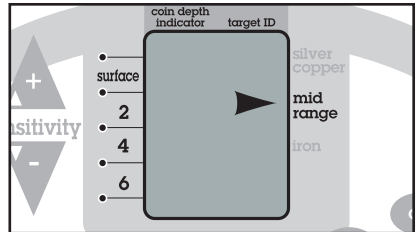

Iron: _____

All ferrous objects, and some smaller aluminum objects, fall into the iron category. Small gold objects can also fall into this range.

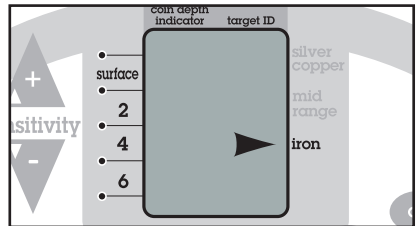

The BOTTOM RIGHT SIDE of the display will illuminate a Low Battery Indicator symbol if the batteries are discharged. The indicator illuminates, and remains illuminated, when the 9-volt batteries have discharged to a level of 7.35 volts.

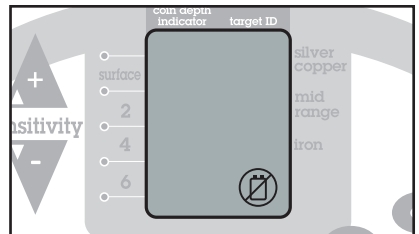

Reading the Display IN THE FIELD

With the detector in use in the field, the display will indicate both the DEPTH and the TARGET IDENTIFICATION of each object detected. After a target is detected, these indicators will remain illuminated with this information until the next target has been detected. If uncertain about the target's identification, try sweeping the coil at a faster speed. A more rapid sweep over a target will generally provide a more accurate target identification.

The MODE CONTROL

The MODE touchpad allows for the elimination from detection of unwanted metal objects.

By pressing MODE, the user toggles among four different discrimination settings.

During MODE (or discrimination) selection, the SENSITIVITY INDICATOR on the left of the display will flash continually. The detector will remain in this discrimination selection mode for 10 seconds until a metal object has been detected.

If an object is detected during mode selection, the detector will exit mode selection. If this happens, you will need to press MODE again and begin mode selection over again. To avoid this, keep the detector stationary and reduce sensitivity before pressing MODE.

The MODE touchpad has two functions:

Each first press of MODE will be followed by.

- ① A distinctive tone or tones, indication the detector's stored discriminating setting.
 - HIGH TONE - no object eliminated.
 - LOW TONE - iron eliminated.
 - MEDIUM TONE - mid-range metals eliminated.
 - LOW & MEDIUM TONE - irons and mid-range metals both eliminated.
- ② Flashing target and sensitivity indicators. The flashing target indicators point to the targets eliminated.

Each **subsequent** press of MODE will toggle between discrimination settings. The flashing arrow indicates the target category eliminated.

The detector will store the current discrimination setting until the power is turned off.

Discrimination Settings are as follows:

Mode	Metals Eliminated	Status Tones	Display (During discrimination selection)
All Metal	None	High	
Iron Discrimination	Ferrous only	Low	
Mid-Range Discrimination	Pull-tabs, Screw Caps, some Foil, medium Gold, Zinc, Nickels	Medium	
Full Discrimination	Ferrous and Mid-Range metals	Low & Medium	

USING HEADPHONES

Using headphones (not included) improves battery life, and prevents the sounds from annoying bystanders.

It also allows you to hear subtle changes in the sound more clearly, particularly if searching in a noisy location. For safety reasons, do not use headphones near traffic or where other dangers are present. This device is to be used with interconnecting cables/headphone cables shorter than three meters.

AUDIO TARGET IDENTIFICATION

While the LCD (Liquid Crystal Display) is very accurate in identifying buried objects, the user in the field does not always maintain the display screen in his field of vision. Therefore, we have incorporated an audio feedback mechanism to alert the user to the nature of buried objects. This audio feedback system first alerts the user to the presence and classification of objects, whose nature and location can be confirmed using the LCD display.

The detector will sound three different tones. These three tones correspond to the three target categories depicted on the LCD display.

LOW TONE

Ferrous objects, such as iron and steel, will induce a low tone. Small gold objects can also induce a low tone.

MEDIUM TONE

Pull-tabs, newer pennies (post-1982), larger gold objects, zinc, small brass objects, and most bottle screw caps will induce medium tones. Many recent vintage foreign currencies will induce medium tones, including loonies & toonies.

HIGH TONE

Silver and copper coins, larger brass objects, older pennies (pre-1982), and highly oxidized metals will induce high tones. Quarters, dimes and other precious coins fall into this category.

LOW TONE



Nails, Bottle Caps,
& Small Gold

MEDIUM TONE



Old & New Pull Tabs, Zinc US Pennies
(Post 1982), Nickel, Larger Gold
Objects, Pennies, Loonies & Toonies.

HIGH TONE



Copper, Silver & Brass
Copper Pennies (Pre 1982)

Audio Target Identification (ATI) classifies metals into three categories.

SENSITIVITY ADJUSTMENT

Upon power-up, the detector defaults to 3/4 sensitivity. To increase to full sensitivity, press the Sensitivity ▲ touch pad.

ELECTROMAGNETIC INTERFERENCE

The principle use for the Sensitivity Control is to eliminate Electromagnetic Interference (EMI).

A hobby metal detector is an extremely sensitive device; the searchcoil creates its own magnetic field and acts like an antenna. If your detector beeps erratically when the searchcoil is motionless, the unit is probably detecting another magnetic field.

Common sources of EMI are electric power lines, both suspended and buried, motors, and household appliances like computers and microwave ovens. Some indoor electronic devices, such as dimmer switches used on household lighting, produce severe EMI and will cause the detector to beep erratically. Other metal detectors also produce their own electromagnetic fields, so if detecting with a friend, keep two metal detectors at least 20 feet apart.

If the detector beeps erratically, **REDUCE THE SENSITIVITY** by pressing the Down-Sensitivity Arrow ▼ on the left of the control panel.

SEVERE GROUND CONDITIONS

A secondary use for the Sensitivity Control is to reduce false detection signals caused by severe ground conditions. While your Outback contains circuitry to eliminate the signals caused by most naturally occurring ground minerals, 100% of all ground conditions cannot be anticipated. Highly magnetic soils found in mountainous and gold-prospecting locations can cause the detector to emit tones when metal objects are not present. High saline content soils and sands can also cause the detector to false.

If the detector emits false, non-repeatable, signals, **REDUCE THE SENSITIVITY**.

MULTIPLE TARGETS

If you suspect the presence of deeper targets beneath a shallower target, reduce the sensitivity to eliminate the detection of the deeper targets, in order to properly locate and identify the shallower target.

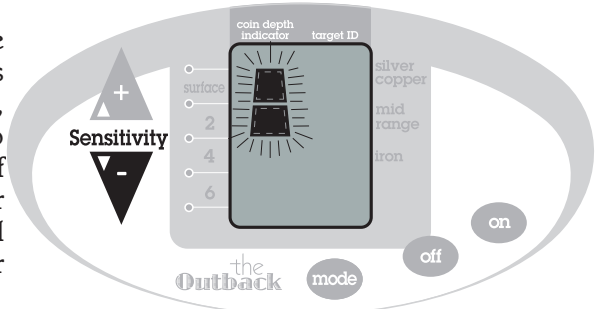

PINPOINTING

Accurate pinpointing takes practice and is best accomplished by “X-ing” the target area.

1. Once a buried target is indicated by a good tone response, continue sweeping the coil over the target in a narrowing side-to-side pattern.
2. Take visual note of the place on the ground where the “beep” sounds.
3. Stop the coil directly over this spot on the ground.
4. Now move the coil straight forward and straight back towards you a couple of times.
5. Again make visual note of the spot on the ground at which the “beep” sounds.
6. If needed, “X” the target at different angles to “zero in” on the exact spot on the ground at which the “beep” sounds.

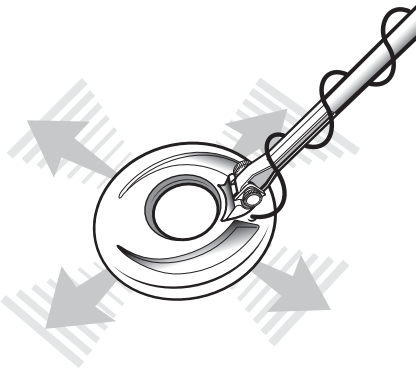

When pinpointing a target, try drawing an “X”, as illustrated, over where the tone is induced.

COIL MOVEMENT

When swinging the coil, be careful to keep it level with the ground about one inch from the surface. Never swing the coil like a pendulum.

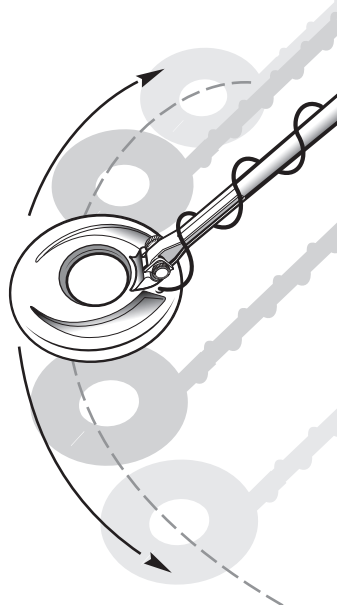
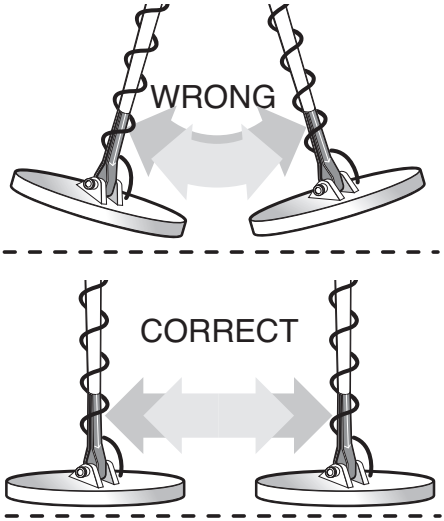

IN THE FIELD TECHNIQUES (continued)

Swing the searchcoil slowly, overlapping each sweep as you move forward. It is important to sweep the coil at a consistent speed over the ground as you search. After identifying a target, your sweep technique can help in identifying both the location and the nature of the target. If you encounter a weak signal, try moving the coil in short, rapid sweeps over the target zone; such a short rapid sweep may provide a more consistent target identification.

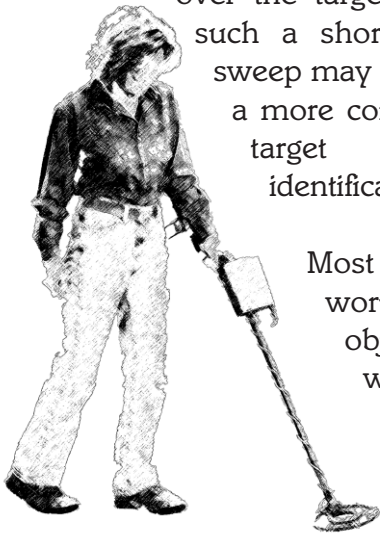

Most worthwhile objects will

respond with a repeatable tone. If the signal does not repeat after sweeping the coil directly over the suspected target a few times, it is more than likely trash metal.

Crossing the target zone with multiple intersecting sweeps at multiple angles is another way to verify the repeatability of the signal, and the potential of the buried target. To use this method, walk around the target area in a circle, sweeping the coil across the target repeatedly, every 30 to 40 degrees of the circle, about ten different angles as you walk completely around the target. If a high-tone target completely disappears from detection at a given angle, chances are that you are detecting oxidized ferrous metals, rather than a silver or copper object. If the tone changes a different angles,

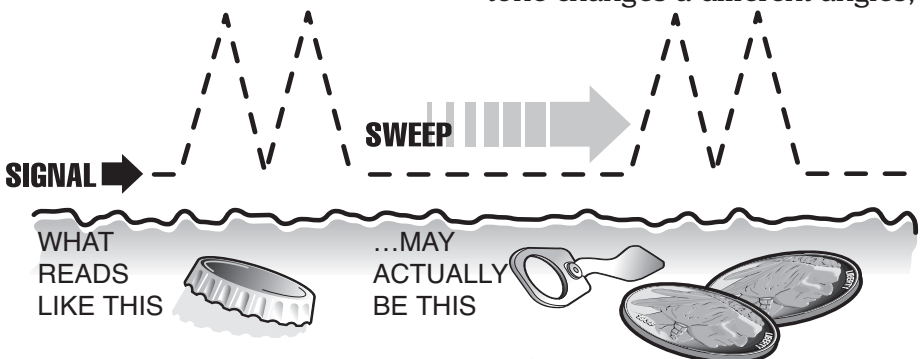

you many have encountered multiple objects. If you are new to the hobby, you may want to dig all targets at first. With practice in the field, you will learn to better discern the nature of buried objects by the nature of the detector's response.

You may encounter some false signals as you proceed. False signals occur when the detector beeps, but no metal target is present. False signals can be induced by electromagnetic interference, oxidation, or highly mineralized ground soils. If the detector beeps once, but does not repeat the signal with several additional sweeps over the same spot, there is probably no target present.

When searching very trashing ground, it is best to scan small areas with slow, short sweeps.

You will be surprised just how much trash metal and foil you will find in some areas. The trashiest areas have been frequented by the most people, and frequently hold the most promise for finding the most lost valuables.

Also maintain the searchcoil positioned just above the surface of the ground, without making contact with the ground. Making contact with the ground can cause false signals.

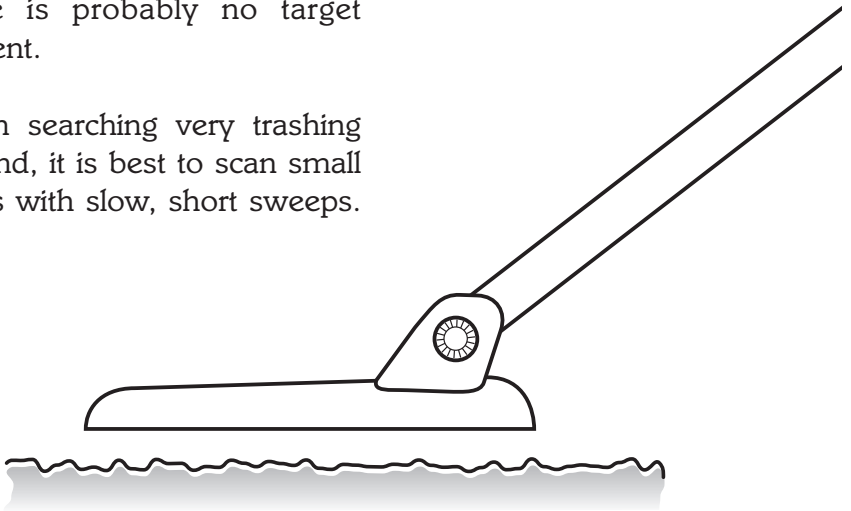

TROUBLESHOOTING

TROUBLESHOOTING GUIDE

SYMPTOM	CAUSE	SOLUTION
Detector chatters or beeps erratically	<ul style="list-style-type: none"> • Using detector indoors • Using detector near power lines • Using 2 detectors in close proximity • Highly oxidized buried object • Environmental electromagnetic interference 	<ul style="list-style-type: none"> • Use detector outdoors only • Move away from power lines • Keep 2 detectors at least 20' apart • Only dig up repeatable signals • Reduce sensitivity until erratic signals cease
Constant low tone or constant repeating tones	<ul style="list-style-type: none"> • Discharged batteries • Wrong type of batteries 	<ul style="list-style-type: none"> • Replace batteries • Use only 9V alkaline batteries
LCD does not lock on to one Target-ID or detector emits multiple tones	<ul style="list-style-type: none"> • Multiple targets present • Highly oxidized target • Sensitivity set too high 	<ul style="list-style-type: none"> • Move coil slowly at different angles • Reduce sensitivity
No power, no sounds	<ul style="list-style-type: none"> • Dead batteries • Cord not connected securely 	<ul style="list-style-type: none"> • Replace batteries • Check connections

TREASURE HUNTER'S CODE OF ETHICS:

- Always check Federal, State, County and local laws before searching.
- Respect private property and do not enter private property without the owner's permission.
- Take care to refill all holes and leave no damage.
- Remove and dispose of any and all trash and litter found.
- Appreciate and protect our inheritance of natural resources, wildlife and private property.
- Act as an ambassador for the hobby, use thoughtfulness, consideration and courtesy at all times.
- Never destroy historical or archaeological treasures.
- All treasure hunters may be judged by the example you set; always conduct yourself with courtesy and consideration of others

5-YEAR LIMITED WARRANTY

Bounty Hunter Metal Detectors are warranted against defects in workmanship or materials under normal use for five years from date of purchase to the original user. Liability in all events is limited to the purchase price paid. Liability under this Warranty is limited to replacing or repairing, at our option, any Bounty Hunter Detector returned, shipping cost prepaid, to First Texas Products, L.L.C. Damage due to neglect, accidental damage or misuse of this product is not covered by this warranty.

Proof of Purchase is required to make a claim under this warranty.

NOTE TO CUSTOMERS OUTSIDE THE U.S.A.

This warranty may vary in other countries, check with your distributor for details.
Warranty does not cover shipping costs.

According to FCC part 15.21 Changes or Modifications made to this device not expressly approved by the party responsible for compliance could void the users authority to operate this equipment.

This device complies with FCC Part 15 Subpart B Section 15.109 Class B.

Copyright© 2019 by First Texas Products, L.L.C.

All rights reserved, including the right to reproduce this book, or parts thereof, in any form.

Published by First Texas Products, L.L.C.

Bounty Hunter® is a registered trademark of First Texas Products, L.L.C.

www.detecting.com



First Texas Products, LLC
1120 Alza Drive
El Paso, TX 79907
(915) 633-8354



ACCESSORIES

Carry Bag

Rugged double-stitched construction
CBAG2

Pouch & Digger Combo

Pouch with 2 large pockets & 9" heavy duty digging tool. TPKIT-W

Stereo Headphones

Use with Bounty Hunter metal detectors. Lightweight and adjustable with true stereo sound, adjustable volume, 1/8 jack with 1/4 adaptor, 4' cable. HEAD-W

Pin Pointer

Pinpoints the exact location of buried metal objects. Audio signal indicator and vibrator. Runs on 1 – 9-Volt Battery. PIN POINTER-W

Sand Scoop

Large scoop with filtering holes. Made of strong plastic. SAND SCOOPBH

Replacement Searchcoil

7" Standard Coil (replacement) - 7COIL-EX

9" Heavy-Duty Digging Tool

Metal blade with comfortable plastic handle and depth gauge TROWEL-2

Digging Tool

Light and practical wide blade digging tool. TROWEL-W

Bounty Hunter® Baseball Cap

One size fits all, with Bounty Hunter® logo. BHCAP

Bounty Hunter® T-Shirt

100% cotton with Bounty Hunter® Logo. Sizes – S, M, LG, XL & XXL
BHTSHIRT

Gold Prospecting Kits

Items Included:

	Gold Kit PART NUMBER: GOLDKIT1	Deluxe Kit PART NUMBER: GOLDKIT2	Hardrock Kit PART NUMBER: GOLDKIT3
10 1/2" Gold Pan	x	x	x
14" Gold Pan	x	x	x
Classifier		x	x
2 – Shatterproof Vials	x	x	x
Snuffer Bottle	x	x	x
Black Sand Magnet		x	x
Treasure Scoop		x	x
Tweezers			x
Magnifier			x
Crevice Tool			x
Rock Pick			x
Instruction Booklet	x	x	x
Backpack		x	x

FOR COMPLETE DETAILS VISIT WWW.DETECTING.COM • 1-800-413-4131