

FISHER RESEARCH LABS

ID EDGE

Target I.D. Metal Detector



Operating Manual

CONTENTS

About Your Detector	pg. 3
Setting Up	pg. 4
Control Panel	pg. 6
4 Tone Audio System.....	pg. 10
Pinpointing	pg. 10
LCD Identification System.....	pg. 11
Auto Ground Balance	pg. 12
Additional Features	pg. 13
Searching	pg. 14
Battery Replacement	pg. 16
Maintenance	pg. 17
Treasure Hunter's Code of Ethics	pg. 17
Headphones.....	pg. 18
Specifications	pg. 19

ABOUT YOUR DETECTOR

Your ID EDGE was engineered to give you the edge in treasure hunting with deep detection and accurate target ID. The ID EDGE is really 3 detectors in 1 with programming to find old coins & relics, modern coins and gold jewelry. Featuring superior target separation, trash rejection and a fast automatic ground balance system, you'll soon find that value and performance come standard with the ID EDGE.

Read this instruction manual thoroughly, practice often and you will be ready for some exciting and rewarding treasure hunting. Drop us a line if you have any questions, comments or good finds to tell us about. In the meantime...

Happy Hunting!
Fisher Labs

SETTING UP

Your Fisher ID EDGE is built to last for years. Handle it carefully, care for it regularly, and it will give you years of dependable service. The ID Edge requires little assembly.

1. Unpack your ID EDGE carefully and save the carton: it may come in handy if you ever have to return the instrument for service.
2. Slip the middle assembly into the upper handle.
3. Adjust the stem length and coil angle so that the search coil rests flat on the ground about 6 to 12 inches in front of and slightly to the right of your right foot (to the left of your left foot for left handers). Your arm should be straight and relaxed, the grip held loosely (see drawing on next page). The stem length is adjusted by loosening the lower lock nut and allowing the spring clip to snap into one of the

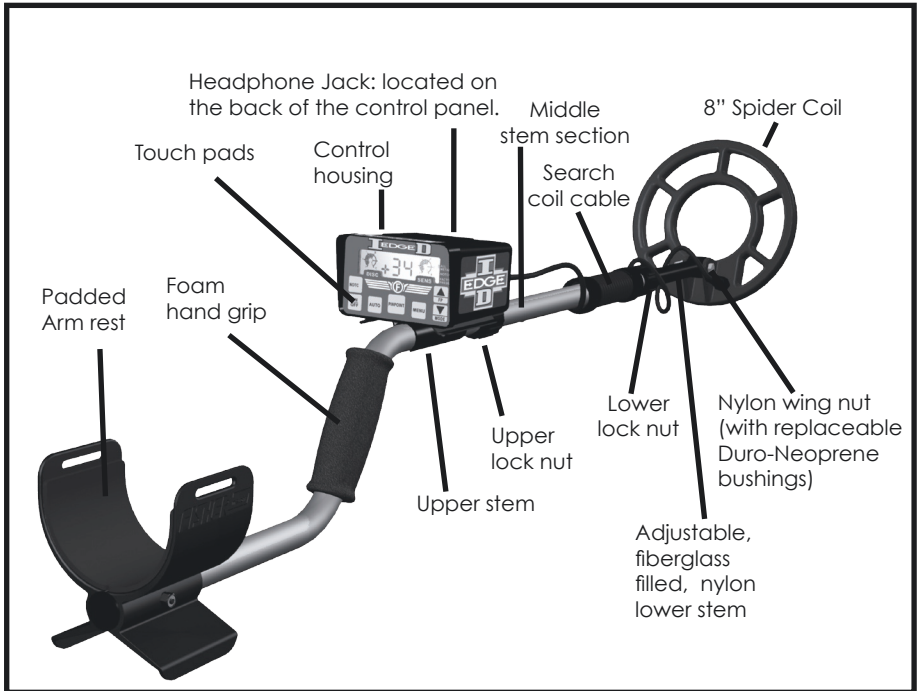

SETTING UP

holes in the center stem. The coil angle is adjusted by loosening the nylon wing nut on top of the search coil.

NOTE: Remember, the longer the shaft, the more you'll have to bend your elbow to keep the coil off the ground and the sooner your arm will get tired. The ID EDGE is balanced for comfortable searching in a tight semicircle around the front of the operator.

4. With the stem length properly adjusted, wrap the search coil cable snugly around the lower stem and the center section. Leave just enough slack near the coil to allow it to be tilted completely backward and forward.

NOTE: A loose cable near the search coil may cause false signals, but don't wrap it so tightly that it pulls against the housing or the coil.

5. Reconnect the coil cable to the control housing. Be careful not to cross thread it and make sure it's snug, but hand tightened only.

6. With the shaft length and coil angle properly adjusted, you should be able to move into your search position by leaning forward very slightly and raising the angle so the coil rests flat on the ground about 6 to 12 inches in front of your arm.

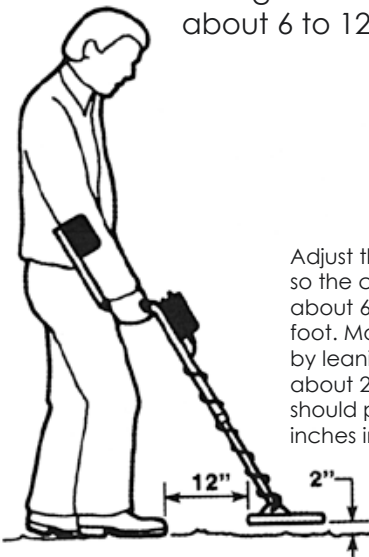

Adjust the stem length and coil angle so the coil rests flat on the ground about 6 to 12 inches in front of your foot. Move into your "search" position by leaning slightly and raising the coil about 2 inches off the ground. This should put the coil about 12 to 18 inches in front of your lead foot.

CONTROL PANEL

The ID EDGE control panel is an all new digital I/O System. The LCD Display provides you with a constant control readout showing you all of your current settings.

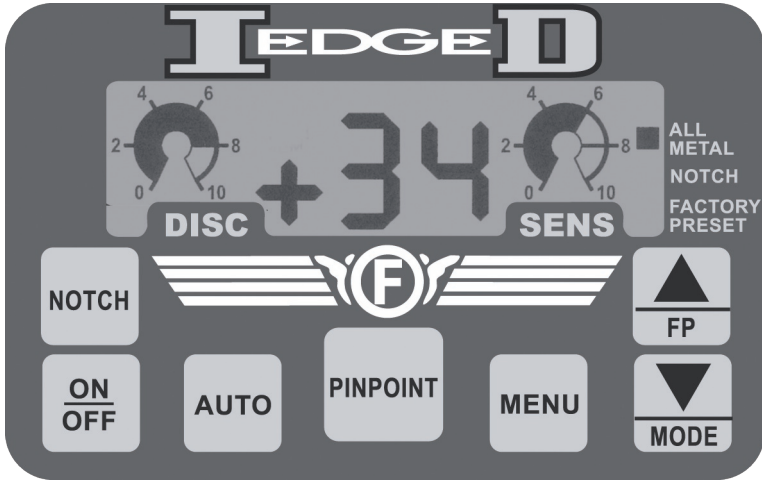

1. The ON/OFF button turns the unit ON and OFF. One of the first things you will notice when you turn on your ID Excel is the battery level display. Fresh batteries will show 9 volts; when the battery level is down to 6 volts, you have about an hour of battery life left. The detector will not turn on if the search coil is not properly connected. This can prove to be a timesaving safeguard. To turn the unit OFF, push and hold the ON/OFF button.

2. The MENU button enables you to enter the “menu mode,” in which you can adjust the discrimination, volume and sensitivity controls with the UP/DOWN arrow buttons. Notice that when the MENU button is pushed, the active control blinks — this is the control that can be adjusted with the UP or DOWN arrow buttons. To move to the next control, just press the MENU button again. When you have all your settings completed, press the Pinpoint button to return to the search mode.

A. The DISCRIMINATION control can be varied from a setting of -36 to +22 with the arrow buttons when the DISC icon is flashing.

B. The VOLUME control can be varied from a setting of V1 TO V9 with the arrow buttons when the "V" icon is flashing,

DISCRIMINATION CHART (APPROXIMATE)

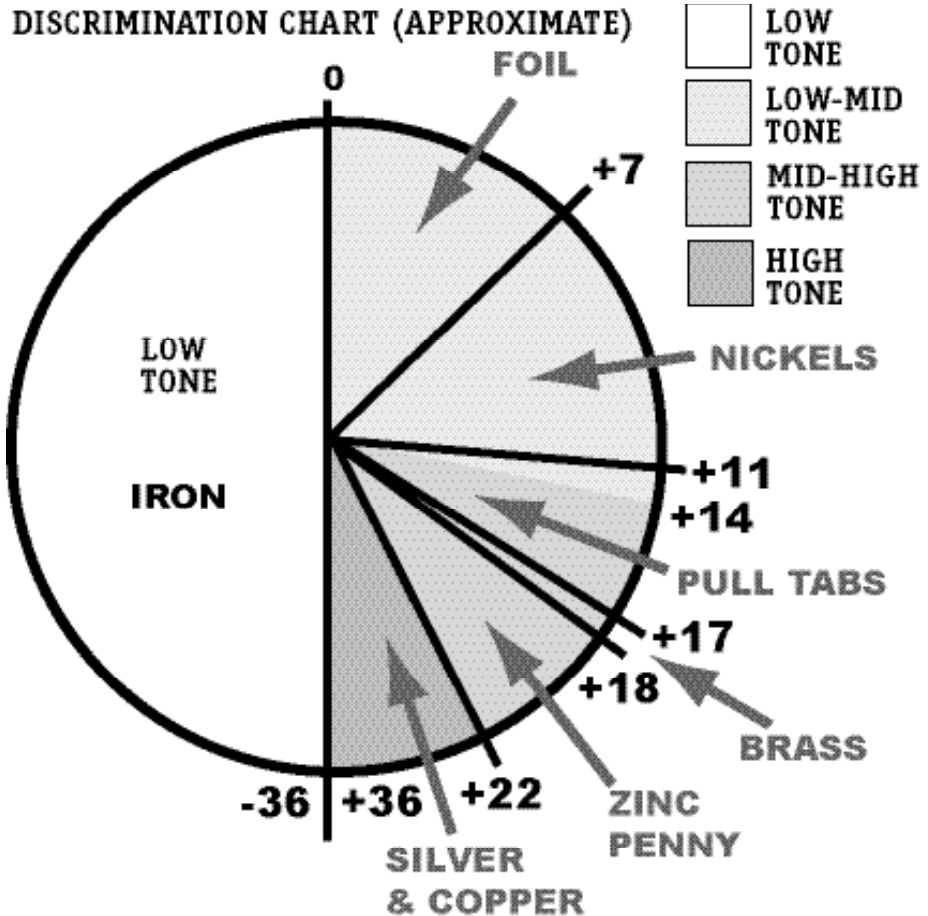

C. The SENSITIVITY control can be varied from a setting of 1 to a maximum of 10 with the arrow buttons when the SENS icon is flashing. As with most detectors, set the sensitivity higher for best depth performance in soils that are low in mineralization. As the mineralization gets worse, lower the sensitivity setting as needed. Please note that a SENS setting of 1 will still yield excellent results.

Remember, to exit the MENU mode at any time, simply press & release the PINPOINT button to return to the SEARCH mode

3. The NOTCH button enables you to select between the NOTCH discrimination options. Push this button repeatedly to select from:

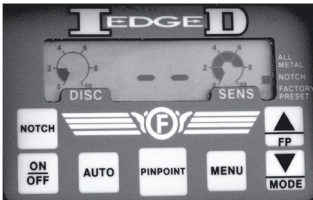
LCD Displays:**NOTCH:**

OFF - No NOTCH selected.

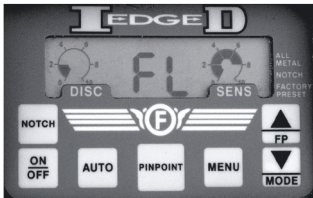

FOIL NOTCH

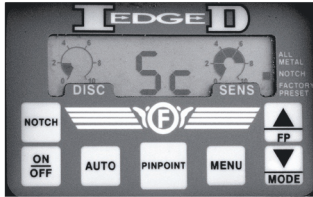

NICKEL NOTCH

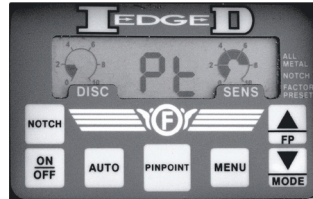

PULL TAB NOTCH

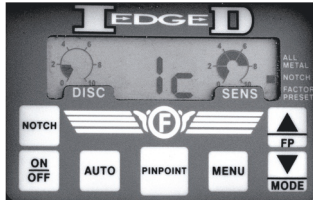

ZINC PENNY NOTCH

The NOTCH mode is only active if you are in the DISC mode (not ALL METAL). If a NOTCH is activated, the LCD "NOTCH" icon will stay on.

CONTROL PANEL

4. The PINPOINT button is used to return to the search mode after you set all MENU settings when it is pushed and released. If the PINPOINT button is pushed and held while hunting, the Precision Visual Pinpoint Mode will be activated. Pinpointing is explained in more detail on page 8.
5. The MODE button enables you to toggle between two operating modes: a “true” all metal detecting mode or, with an advanced discrimination system activated. To switch between the two modes while hunting, press the arrow down/mode button. The LCD “ALL METAL” icon will stay on if ALL METAL mode is selected.
6. The Factory Preset “FP”: Fisher recommends that for a quick start setup or while you are learning to hunt with your ID Edge, that you use factory preset mode. Factory preset modes can be set by pressing the FP button. The operating mode must be set to DISC, not ALL METAL.

cP - Preset OFF
(customer preference
of disc & notch)

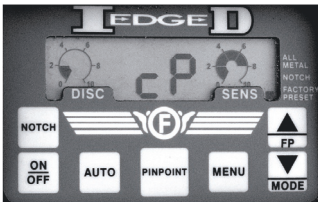

oC - OLD COIN
Target ID Range Accepted:
+5 to +12 and +16 to +36

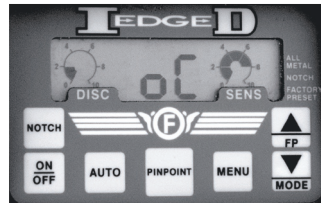

JL - GOLD JEWELRY
Target ID Range Accepted:
0 to +18

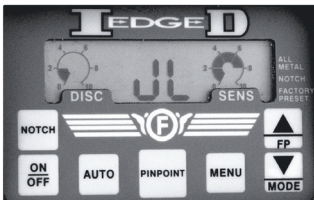

nC - NEW COIN
Target ID Range Accepted:
+8 to +12 and +20 to +36

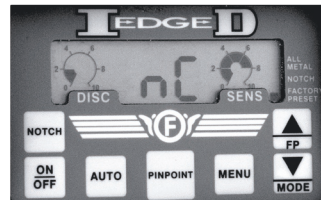

7. The AUTO button allows you to achieve a precision ground balance with one touch. AUTO ground balance is explained in detail on page 10.

4 TONE AUDIO SYSTEM

The four-tone audio system provides you with more information per sweep, acting as a target I.D. system in the “discrimination” mode. While sweeping the ID EDGE search coil over a target, you will hear one of four tones:

LOW TONE = Iron objects (ferrous)

LOW/MID TONE = Foil, Nickel, Round Tabs

MID/HIGH TONE = Square Tabs, Zinc Pennies

HIGH TONE = Copper, Clad, Silver Coins

If a bell tone audio is heard, accompanied by an “OL” on the LCD, the coil has encountered a larger or shallow target and the search coil must be lifted to avoid overload and inaccurate I.D. When hunting in the ALL Metal mode, a single tone will be heard for any metal object the coil is swept over. This mode responds much like the “auto tune” mode of previous detectors.

PINPOINTING

When the Pinpoint button is pushed and held, the non-motion pinpoint mode is activated. This pinpoint mode may be familiar in some ways (when the target is approached, the audio intensity increases), but different in others (the digital numeric indicator). The two digit (0-99) LCD will help you to accurately pinpoint your target by increasing in value as the center of the target is approached. This gives you much more resolution in pinpointing than a “depth estimation” system, and allows you to characterize size, shape, and location of your target better.

LCD IDENTIFICATION SYSTEM

The LCD will also show you an indication of the type of target you have found, in conjunction with the audio tones, by showing you a number preceded by a “-” or “+” sign. The target identification system works as follows:

When in either search mode (ALL METAL or DISC), a target will produce a number between 0 and 36 indicating target type.

In addition, the - or + sign in front of the number indicates whether the target is ferrous in nature (an iron target) “-” / or nonferrous (a non-iron target) “+”.

The target I.D. numbers correspond to the following target types:

All negative (-) numbers:	Iron
+0 to +8:	Foil
+9 to +11:	Nickel
+17 to +18:	Square Tab/Brass
+20 to +22:	Zinc Pennies
+28 to +30:	Copper pennies, dimes
+30 to +34:	Quarters
+34 to +36	Silver

Remember, this Numeric I.D. system is activated in either the All-Metal or Disc. modes (although the 4-tone audio I.D. is only active in the Disc. mode).

Also, the discriminator can silence the audio for certain targets, but the two-digit I.D. will always reveal the target identity.

AUTO GROUND BALANCE:

The precision automatic ground balance system will provide ground balance accuracy that exceeds any setting achieved manually. The procedure is quite simple: After you have set up your controls and are back in the search mode, lower the search coil to the ground in an area completely void of metal. Next, press the AUTO button and hold it for about 2 seconds. Then, while still holding the AUTO button down, lift the coil about 6 inches off the ground, hold for a second, and release the button. The ID EDGE will give you a brief tone to let you know the ground balance has been achieved. This procedure can be repeated at any time, as you change your settings or ground conditions change. It is fast and accurate. If the detector gives you 3 brief tones it is letting you know that the ID EDGE was already balanced correctly or it is indicating the presence of metal under the target. Move to another location and repeat the auto ground balance procedure. If you get 3 brief tones a second time, continue hunting as your detector is most likely ground balanced and should not give you any false signals while hunting.

STEP #1 - Lower to ground



STEP #2 - Press & hold for 2 seconds

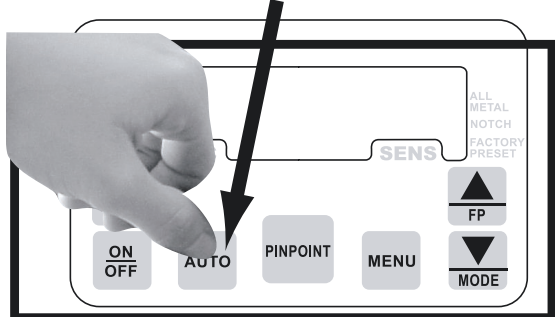

STEP #3 - [while still pressing AUTO]
Lift coil 6" off ground & release button.
Listen for a brief tone.

*WHEN TONE SOUNDS,
THE UNIT IS PROPERLY
GROUND BALANCED

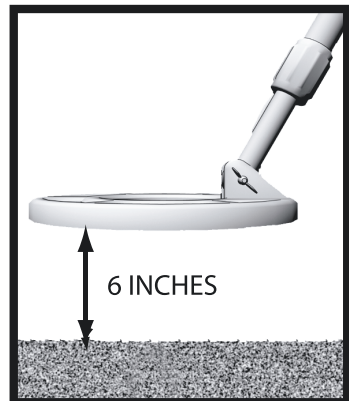

ADDITIONAL FEATURES

AUTOMATIC LOW BATTERY WARNING: The ID EDGE will let you know when a low battery condition will begin to effect performance — the batteries must be changed at this time. When the batteries get too weak, the audio system will produce a wavering tone to alert you to the low battery condition, and the LCD will flash “LO”.

AUTOMATIC SIGNAL OVERLOAD WARNING: The ID EDGE will alert you to the presence of a large metal object in close proximity to the search coil by sounding off an audio bell tone. This lets you know that the object is too close to the coil for the 4-tone audio or LCD systems to accurately identify the object.

CONSTANT CONTROL READOUT: Unlike many digital detectors, the ID EDGE LCD shows you the control settings at all times while in the search mode. The control icons are similar to the knobs of older detectors, constantly showing where the settings are at in one easy glance. In addition, even more accurate information regarding the control settings can be obtained by entering the MENU mode and observing the two-digit number accompanying each control, showing improved resolution of each control.

SEARCHING

Good search techniques are every bit as important as having a good detector.

1. Once your controls are properly set, press and release the P/P touch pad, and move into your search position. Begin your search by walking slowly and sweeping the search coil in a tight semicircle.
2. Keep the coil parallel to the ground and as close to the ground as practical. This is extremely important for maximum coverage and depth. If you're searching on a lawn, you may set the coil right on the grass and lightly "scrub it."

Keep the search coil as close to the ground as possible for greater penetration, and make sure the search coil remains parallel to the ground as you search.

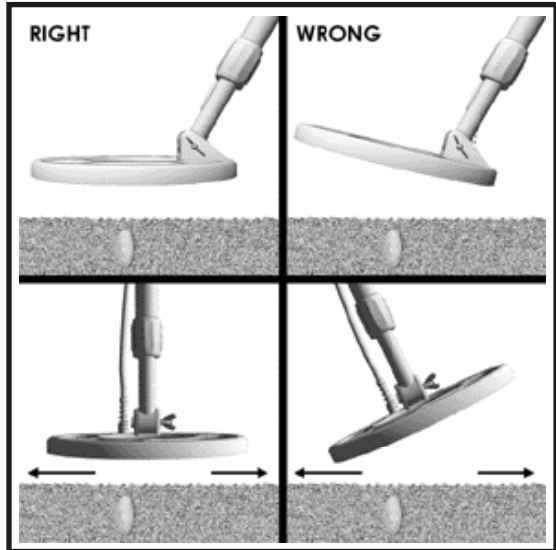

3. Overlap your sweeps by at least 50 percent. Remember that your coil's search pattern is conical and if you don't overlap each sweep you'll miss the deeper targets.
4. Search in a methodical manner. Pay close attention to where you're going and where you've been so that you don't retrace your steps or miss any productive areas.

5. Keep the search coil moving at a comfortable rate.
6. Take your time. If you walk too fast you can overlap your sweeps and you'll miss a lot of ground. If you swing your coil too fast, you could lose some sensitivity to deep and/or small targets.
7. The illustration below shows the ID EDGE search coil pattern and how it is effected by sweep speed, ground mineralization and search mode.

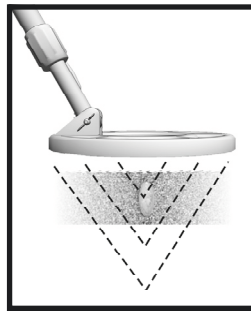

The conical search pattern of the ID EDGE search coil means you'll get better ground penetration and coverage by overlapping your sweeps.

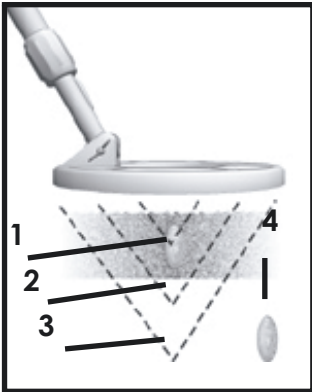

Effects of sweep speed, ground mineralization and search mode

1. **Minimum depth**
 - a. Very slow or very fast sweep speed
 - b. Highly mineralized soil.
2. **Good depth**
 - a. Moderate sweep speed
 - b. Moderately mineralized soil
3. **Maximum depth**
 - a. Moderate sweep speed
 - b. Non-mineralized soil
4. **Missed target**
Many targets well within the range of your ID EDGE will not be detected unless you overlap your sweeps.

Unlike other metal detectors, the discrimination settings have little if any effect on the depth capability of the ID EDGE. Depth is also determined by the size, shape and conductivity of the target as well as the sensitivity setting of the ID EDGE.

BATTERY REPLACEMENT

Battery replacement is simple with the ID EDGE drop-in battery compartments: just pop the doors open. Two 9-volt transistor batteries are located in separate compartments at the rear of the housing. When it's time to replace the batteries, always replace both of them.

1. To open the battery compartments, press gently down and out on the battery door latch. The doors are tethered; do not attempt to completely remove them.
2. Tilt the housing gently and the batteries will slide out.
3. Insert the new batteries. Make sure the contact end goes in first and that you match the polarity markings on the control housing.
4. To close, simply hook the lower edge of the battery door over the inside of the battery compartment and gently push shut.
5. Some replacement brands are slightly larger in size and may be a tight fit.



MAINTENANCE

Your ID EDGE doesn't require a lot of care. It's built with high-quality materials. But there are a few things you should do to keep it in peak operating condition.

1. If you're not going to be using it for a while, take the batteries out. Acid damage caused by leaking batteries can be severe.
2. Avoid extreme temperatures. Don't leave it inside a closed car that's sitting in the sun. Or even worse, the trunk of a car.
3. If you "scrub" the search coil on the ground, you'll eventually wear through the bottom of the coil. Replacement coils are expensive. Instead, invest in a coil cover; they're cheap.
4. Keep your ID Excel dry and clean. If you've been working in or around dust, wipe it down with a damp cloth and dry it with a hair dryer (low or no heat) or a dry cloth. Remove and clean the lower stem. Keep the lock nuts free of sand and dirt.

TREASURE HUNTERS' CODE OF ETHICS

LET'S PRESERVE OUR TREASURED SPORT!

Laws governing the use of metal detectors are becoming more and more common. In many countries, the use of metal detectors is illegal or severely restricted. Don't let this happen in your area.

- Always check Federal, State, County and local laws before searching.
- Respect private property and do not enter private property without the owner's permission.
- Take care to refill all holes and try not to leave any damage.
- Remove and dispose of any and all trash and litter found.
- Appreciate and protect our inheritance of natural resources, wildlife and private property.
- Act as an ambassador for the hobby, use thoughtfulness, consideration and courtesy at all times.
- Never destroy historical or archaeological treasures.
- All treasure hunters may be judged by the example you set; always conduct yourself with courtesy and consideration of others.

USING HEADPHONES

Using headphones (not supplied) improves battery life, and prevents the sounds from annoying bystanders.

It also allows you to hear subtle changes in the sound more clearly, particularly if searching in a noisy location. For safety reasons, do not use headphones near traffic or where other dangers are present. This device is to be used with interconnecting cables/headphone cables shorter than three meters.

SPECIFICATIONS

Subject to improvement, modification or change without notice.

FREQUENCY

- 1. Operating Frequency..... 6.25 kHz
- 2. Audio Target Response:
 - Iron ID (LOW TONE)
 - Foil, Nickel, Rnd. Tabs (MID/LOW TONE)
 - Square Tabs, Zinc (MID/HIGH TONE)
 - Copper, Clad, Silver Coin (HIGH TONE)

LENGTH

- Extended..... 52" Collapsed ³..... 42"

WEIGHT

- Complete 2.76 lbs with 8" coil

OPERATING MODES

- ID discrimination with 4 tone audio & high resolution numeric target ID ⁴
 - Normal DISC (-36 to +22)
 - Notch DISC: "FL"= foil, "5c"= nickel, "Pt"= pull-tab, "1c"= zinc penny, ""= none
 - Factory preset programs: "OC"= old coins, "MC"= modern coins, "JL"= gold jewelry "cP"= none
- True ALL-Metal mode with single tone & high resolution numeric target ID ⁴
- Pinpoint - no motion mode with precision numeric readout

SPECIAL FEATURES

- Controls..... keypad with tactile response
- Display..... LCD with constant control readout
- Audio4-tone digital audio ID system
- Factory Preset Modes..... Yes (Old Coins, Modern Coins, Jewelry)
- DISC control Yes
- SENS control Yes
- Volume control..... Yes
- Notch Disc Yes
- Fast Automatic Ground Balance..... Yes
- Last Setting Memory..... Yes
- Audio OutputStereo Jack Stereo Headphones (Optional)
- Speaker..... Built in

SEARCH COIL

- Type..... Concentric, Co-planar Spider
- Diameter......8"
- Shielding.....100% ESI ⁶
- Submersible Coil Yes

- Drop-in, no wires Yes

BATTERIES

- Automatic Battery Level Readout Yes
- Automatic Low Battery Alert..... Yes
- Type Two, 9-Volt Alkaline 5

WARRANTY

5-Year Limited Warranty*

*warranty may vary outside of the United States, warranty applies to the original purchaser only. see your dealer for details.

NOTES

1. Subject to improvement or modification without notice.
2. Approximate.
3. The ID Edge disassembles to fit into an optional carrying case measuring approximately 6"x 21" x 15".
4. The ID Edge is a motion detector in the All Metal and Target ID modes. The search coil must be moving at least slightly to detect a target.
5. For maximum performance and battery life, always use Alkaline Batteries.
6. ESI: Electro-Static Insulated to eliminate certain types of false signals.

FISHER RESEARCH LABS

QUALITY

Fisher detectors are renowned for their quality.
Each detector is hand crafted in the USA with pride

PERFORMANCE

Treasure Hunters worldwide rely on Fisher.
Our detectors are durable, dependable, and search deeper..

REPUTATION

Fisher produced the first patented metal detector in 1931. For
over 80 years, the Fisher logo has been a mark of excellence.

5 - YEAR LIMITED WARRANTY

Fisher believes in the products we produce and backs this belief
with a 5 year limited warranty.

Proof of purchase is required to make a claim under this warranty.

NOTE TO FOREIGN COUNTRY CUSTOMERS

This warranty may vary in other countries, check with your
distributor for details.

Warranty does not cover shipping costs.

According to FCC part 15.21 Changes or Modifications made to this device not
expressly approved by the party responsible for compliance could void the users
authority to operate this equipment.

SERVICE

Fisher is committed to providing you, our valued customer, with
superior service. Each and every instrument is rigidly tested
and carefully inspected during assembly and before shipment.

Should you have any questions or problems, contact:

FISHER RESEARCH LABORATORY

1120 Alza Drive,
El Paso, Texas 79907

Tel 915.225.0333 Fax 915.225.0336

www.fisherlab.com email:info@fisherlab.com