



PROFESSIONAL METAL DETECTOR

OPERATING MANUAL

Use **ALKALINE**
Batteries **ONLY**



Also available
with 11"DD coil
(Item# F5-11DD)

- Large Display Screen
- Continual Visual Indication of Important Parameters:
 - Target Identification
 - Target Confidence
 - Target Depth
 - Ground Phase
 - Detector's Internal Ground Setting
- Three Search Modes
 - Discrimination
 - All Metal Autotune
 - Static PinPoint
- Computerized and Manual Ground Balancing
- Waterproof 9 3/4" open-frame concentric elliptical searchcoil
- Controls

Ground Balance	Frequency
Discrimination	Notch
Threshold	Tones
Gain	Phase Lock
Pinpoint	

FISHER ^{RESEARCH}
LABS

TABLE OF CONTENTS

Assembly	3
Batteries	4
Headphone Jack	4
Quick-Start Demo	5-6
Control Panel	7-11
Phase Lock	7
Tones	7
Notch	7
Frequency	8
Pinpoint	8
Gnd Bal	9
Gain	9
Threshold	10
Discrim	10-11
Ground Balancing	12-14
Ground Balancing -Technical Information	13-14
Audio Target Identification System	15
Depth and Target Display	16-17
Target Readout Table	17
Understanding the Display	18-19
Mode Indication	18
Target Categories	18
Discrimination Indicators	18
Target-ID	18
Depth	18
Confidence	18
Battery Indicator	19
% Fe ₃ O ₄	19
Phase	19
Setting	19
Search Techniques	20
Target Verification	20
Pinpointing with motion modes	20
Target Pinpointing (No motion)	21
Unit Specifications	22
Warranty	23
Accessories	Back Cover

ASSEMBLY

Caution: Forcing in MIDDLE STEM with CAM LOCK raised may form a burr on cam lock. If this happens, remove burr with knife to allow insertion.

- 1 Position detector upright.
- 2 Rotate the LOCKING COLLAR fully in the counterclockwise direction.
- 3 Insert your finger inside the tube and make sure the INTERNAL CAM LOCK is flush with the inside of the tube.

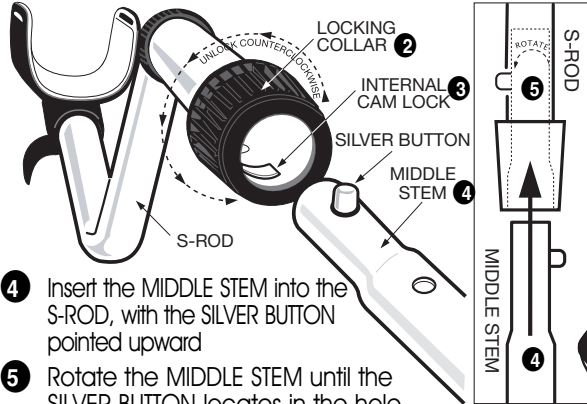

- 4 Insert the MIDDLE STEM into the S-ROD, with the SILVER BUTTON pointed upward.
- 5 Rotate the MIDDLE STEM until the SILVER BUTTON locates in the hole.
- 6 Twist the LOCKING COLLAR fully in the clockwise direction until it locks.
- 7 Repeat this process on the LOWER STEM.
- 8 Using the BOLT and KNURLED KNOB, attach the SEARCHCOIL to the LOWER STEM.
- 9 Adjust the LOWER STEM to a length that lets you maintain a comfortable upright posture, with your arm relaxed at your side, and the SEARCHCOIL parallel to the ground in front of you.
- 10 Wind the CABLE securely around the STEMS, leaving slack at the bottom.
- 11 Connect CABLE PLUG to housing. Do not twist the Cable or Plug. Turn Locking Ring only. Use minimal finger pressure to start the threads. Do not cross-thread. When the Locking Ring is fully engaged over the threaded connector, give it a firm turn to make sure that it is very tight. When the Locking Ring is fully engaged over the threaded connector, it may not cover all of the threads.
- 12 Tighten both LOCKING COLLARS.

Armrest Adjustment

If you wish to change the position of the armrest, remove the screw and move the armrest to one of the alternate hole locations.

Caution: Do not force the plug in. Excess force will cause damage. To disconnect the cable, pull on the plug. *Do not pull on the cable.*

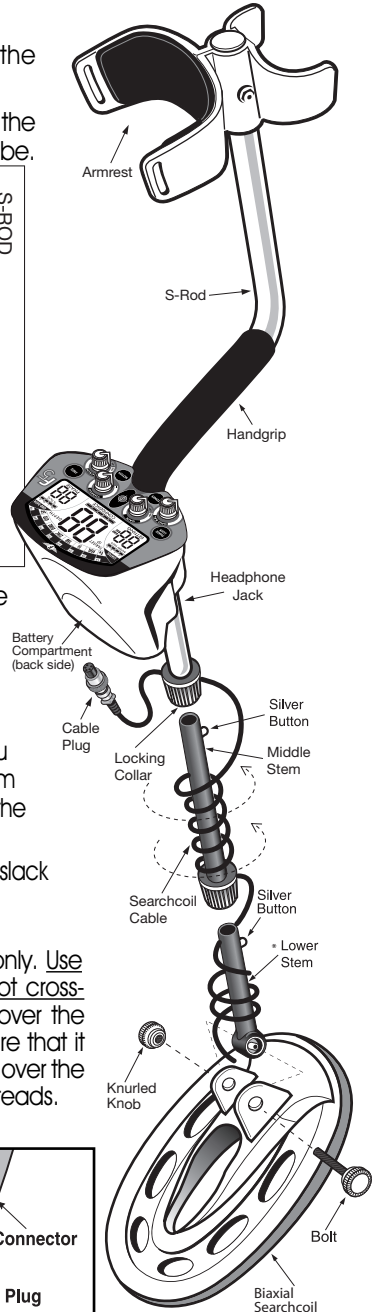
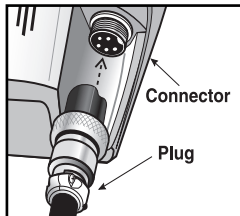

* Note: Very tall users can purchase the optional Extended Lower Stem (TUBE5X), for extended reach.

BATTERIES

Two 9-Volt batteries are supplied with the F5.

The batteries have been inserted backwards in the compartment for storage during transportation.

Please remove batteries, turn them around, and install correctly.

Use **ALKALINE** batteries only.

DO NOT MIX OLD AND NEW BATTERIES.

To install the batteries:

- 1 Remove the battery cover by disengaging the clip at the back. **Do not hinge door upward;** pull straight back
- 2 Align the polarity of the batteries correctly, with the positive "+" toward the coil plug connection, as indicated by the + indicator on the housing.
- 3 Insert (2) 9-Volt **ALKALINE** batteries, with the contacts pointed inward, and press down on the back of the batteries to snap them into place.

Some brands of batteries will require moderate force to clear the retaining tabs.

- 4 Replace the battery door.

Most metal detector problems are due to improperly installed batteries, or the use of non-alkaline or discharged batteries. **If the detector does not turn on, please check the batteries.**

BATTERY DISPOSAL & RECYCLING

Alkaline batteries may be disposed of in a normal waste receptacle or recycled. Non-Alkaline batteries should be recycled. In the state of California all battery types must be recycled. Please refer to local municipalities for detailed disposal and recycling requirements.

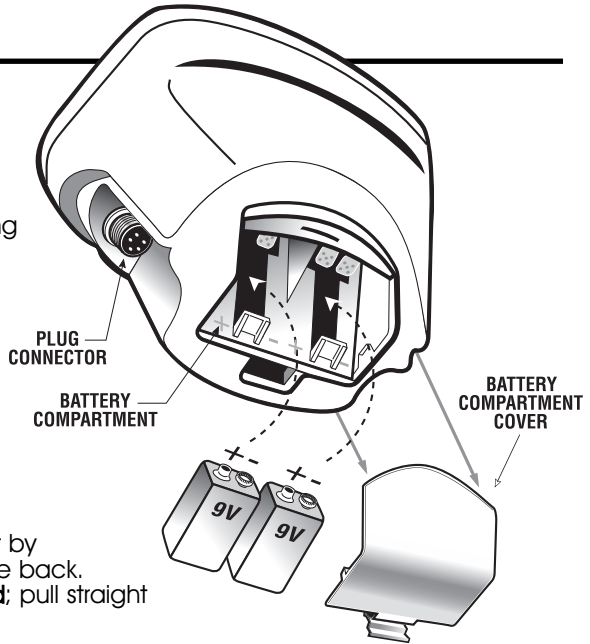

USING HEADPHONES

Using headphones (not included) improves battery life, and prevents the sounds from annoying bystanders.

It also allows you to hear subtle changes in the sound more clearly, particularly if searching in a noisy location. For safety reasons, do not use headphones near traffic or where other dangers are present. This device is to be used with interconnecting cables/headphone cables shorter than three meters.

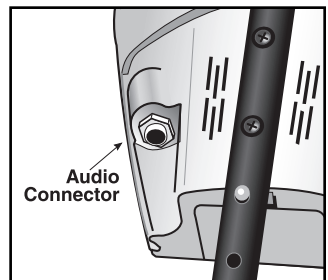

QUICK-START DEMONSTRATION

1. Supplies Needed

- A Nail
- A Nickel
- A Zinc Penny (dated after 1982)
- A Quarter

2. Position the Detector

- Place the detector on a table, with the searchcoil hanging over the edge. (or better, have a friend hold the detector, with the coil off the ground).
- Keep the searchcoil away from walls, floors, and metal objects.
- Remove watches, rings and other jewelry or metal objects from hands and wrists.
- Turn off appliances or lights that cause electromagnetic interference.
- Pivot the searchcoil back toward the detector body.

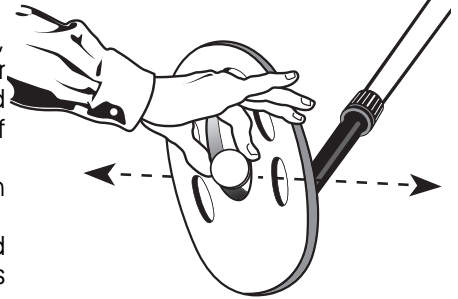

3. Power Up

NOTE: Immediately after powering on, your detector's unique 10-digit serial number is displayed once on the LCD. Two digits are displayed at a time; five 2-digit numbers are displayed in sequence. This 10-digit serial number is the same serial number imprinted on the label inside the battery compartment.

- Click on the On/Off/Gain knob
- Set Gain Knob at the 12:00 position
- Rotate threshold knob to setting= -3

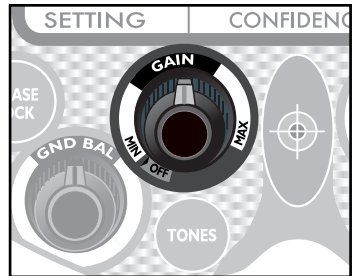

4. Active Discrimination Mode

Click on "Discrim" knob and keep to left, at lowest setting.

5. Wave each object over the searchcoil

- Notice the low tone for the nail.

6. Wave a coin close to, then farther away, from the searchcoil

- Notice that pitch and volume increase as non-ferrous objects get closer to the searchcoil.

7. Press the TONES touchpad

Number of tones setting changes to d3.

8. Wave each object over the searchcoil

Notice the 3 different tones

- Low tone: nail
- Medium tone: nickel and zinc penny
- High tone: quarter

QUICK-START DEMONSTRATION *(continued)*

9. Rotate the DISCRIM knob until 15 appears at the left of the display
10. Wave each object over the searchcoil
Notice that the nail is not detected.
11. Rotate the DISCRIM knob until 65 appears at the left of the display
12. Wave each object over the searchcoil
— Notice that now only the quarter is detected.
— The other objects have been “discriminated out”
13. Press the NOTCH touchpad 3 times until the flashing line is over the 5¢ icon
After a few seconds, the flashing stops
Notice that there is now no slash over the 5¢ icon
14. Wave all objects over the searchcoil.
Notice that the nickel is now detected. You have “notched in” the nickel.
In categories covered with a slash, objects will not be detected.
15. Press-and-Hold the PINPOINT touchpad
Hold an object over the searchcoil.
All metal objects are now detected.
The object’s DEPTH is displayed, in inches, in the center of the display.
Pitch and volume increase as objects get closer to the coil.



CONTROL PANEL

The Touch Pad controls are as follows:

PHASE LOCK

Pressing "Phase Lock" will update the internal ground balance setting.

We recommend pumping the coil, as described in the GROUND BALANCING section of the manual, when using this control. Be aware that a momentary press of the PHASE LOCK button will automatically transfer the currently displayed PHASE value to the GROUND SETTING.

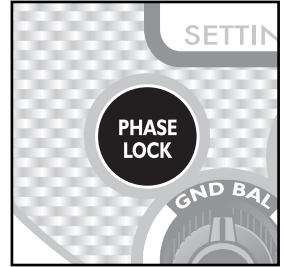

TONES

In Discrimination Mode, the F5 indicates target type by audio tone.

The TONES button allows the user to select one of four different ways to group target types by tone.

Your selection depends on personal preference and search objectives. For example, coin shooters usually select d3 or d4. Relic hunters might select d1 or d2, depending on search area conditions.

In All Metal Mode, the TONES button allows the user to vary the pitch of the base tone.

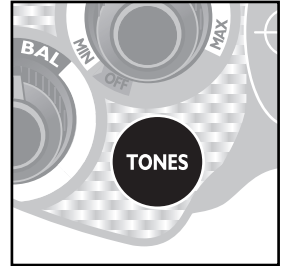

See page 16 for a detailed description of the tones provided for each selection.

NOTCH

The purpose of the NOTCH function is to change the detection status of a target category.

- If a category was not eliminated from detection before being "notched," then notching the category will eliminate it from detection.
- If a category was eliminated from detection before being "notched," (i.e. a "-" covered the icon), then notching the category will return the category to detection.

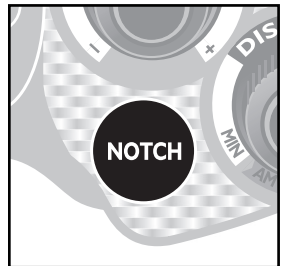

Touch Pad controls continued on next page

CONTROL PANEL

Touch Pad controls continued

Upon the 1st press of NOTCH, a “—” will flash over the “Fe” symbol. Each subsequent press will move the flashing “—” to the right. The following target categories can be notched in or out:

Fe, Foil, 5¢, Tab, Zinc, 50+

After the 50+ category, pressing NOTCH will exit the NOTCH function.

To select a category for notching, press NOTCH until the flashing “—” appears over that category’s icon. After a few seconds, the flashing “—” will time out and the current target category will be notched.

Practice pressing NOTCH a few times and its function will become obvious. The NOTCH feature is not available in Auto Tune Mode.

FREQUENCY

Use this control if detector behaves erratically and you suspect electromagnetic interference from some other electronic device. The control will change the detector’s operating frequency. Press until you find one of the frequencies which minimizes the interference.

Choices are:

- 1 – default frequency
- 2 – 1st alternate frequency
- 3 – 2nd alternate frequency



Changing frequency may require you to change the ground balance setting. See section on ground balancing.

PINPOINT

This touchpad, in the middle of the panel, activates the PINPOINT Mode. Press-and-Hold this touchpad for static detection. Volume and pitch increase with increase in signal strength.

Target DEPTH, in inches, will be indicated in the middle of the display.

The depth indicator is calibrated to coin-sized objects. Objects other than coins will indicate relative depth readings.

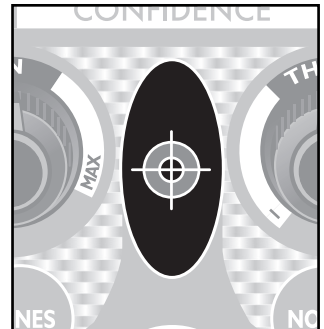

CONTROL PANEL

The Control Knob functions are as follows:

GND BAL — Ground Balance Control Knob

Rotate GND BAL to change the detector's internal Ground Balance Setting.

By calibrating the detector to the actual Ground Phase of the soil you are searching, you will cancel out signals from the earth's naturally occurring minerals, thereby improving your ability to detect buried metal objects.

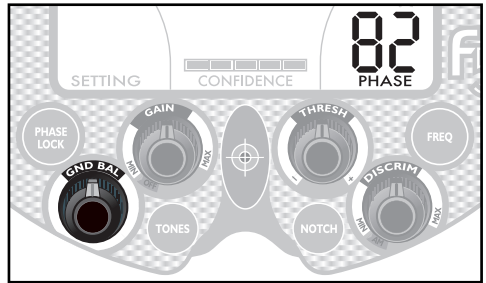

The default ground setting is 82.

The knob has no minimum or maximum set point; it rotates continuously without a stop.

The faster you turn the knob, the more quickly the ground setting changes. To make small changes to the ground setting, move the knob slowly, one click at a time.

There are over 1,000 different ground balance settings, but only 100 different numbers are displayed on the screen, as 2-digit numbers from 00 to 99. The displayed setting will change by one number for roughly 10 clicks of the knob.

See section on Ground Balancing for a detailed description.

GAIN

The gain control increases, or multiplies, the signal from a buried metal object.

Rotate the GAIN knob clockwise in order to increase the size of signals generated. For maximum detection of the smallest or most deeply buried objects, increase the gain. To minimize the weakest signals, set the gain at a low level.

There are 20 gain settings. 5 is the lowest; 99 is the highest.

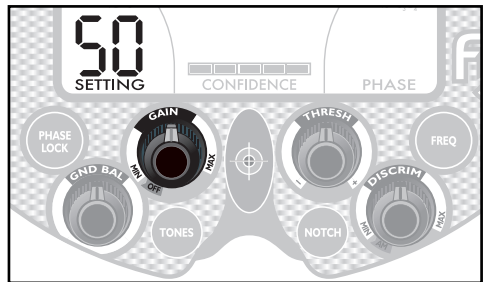

CONTROL PANEL

Control knob functions continued

THRESHOLD

The THRESHOLD control function varies, depending on the mode selected.

In DISCRIMINATION MODE, **negative** threshold values suppress sensitivity. The lower the value, the greater the suppression. This control can be used to eliminate electrical interference or to eliminate response from small trash objects.

In discrimination mode, **positive** threshold values amplify the audio response of weak target signals. Positive threshold selections make weak targets easier to hear (if, for example detecting in a noisy location). If it is necessary to reduce sensitivity, reduce GAIN while maintaining positive threshold values.

In AUTOTUNE MODE, the threshold control can be used in two ways.

For searching at maximum sensitivity, set threshold into the positive region, with a comfortable background hum volume level. Then reduce gain if necessary to reduce chatter.

For silence searching, set threshold to a negative number, and also reduce gain if necessary. Silent searching will result in the loss of some sensitivity.

Threshold values range from -9 to 9. With the knob at the 12:00-position, threshold will be between -1 and -3.

DISCRIM (Mode Selection)

- Click into the far-left position, and the detector enters ALL METAL Mode.
- Click to the right, without rotating, and the detector enters DISCRIMINATION Mode, with multi-tone audio target identification, and no metals eliminated from detection.
- Rotate the knob to the right to eliminate unwanted metals from detection.

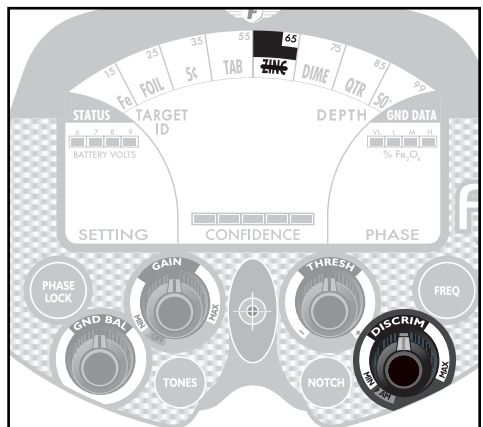
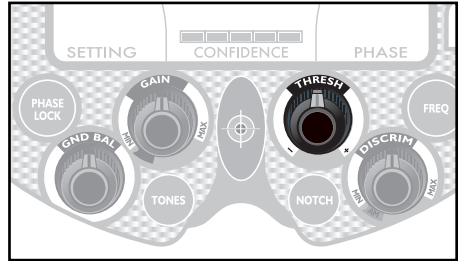

CONTROL PANEL

Control knob functions continued

As you rotate the DISCRIM knob:

- The SETTING value will indicate the Target-ID number to be “discriminated out,” or eliminated from detection. All targets with an ID less than or equal to the SETTING value will not be detected.
- A “—” will appear over icons for those categories being discriminated out.

Note that the “—” will appear when all numbers within that category are discriminated out.

For example, if the DISCRIM knob is set at a SETTING of 55, a “—” will appear over “TAB.” Those objects in the tab category with values from 36 to 55 will not be detected. Objects with values of 56 and up will be detected.

The audio and visual target discrimination systems are independent of one another. In some situations, targets eliminated from visual detection will still produce an audible response. Also, the audible target identification may differ from the visual. The audio discrimination system provides more information about the target than the visual system. Understanding the nuance of the detector’s audio feedback requires some experience.

Control Settings Display

The setting for each control is displayed as a 2-digit number on the bottom left of the screen. Each time you turn a control knob, or press **FREQ** or **TONES**, the setting for that control is immediately displayed above the word “SETTING.”

This 2-digit display value will revert back to the Ground Balance setting after a control is not adjusted for a few seconds.

When the SETTING value represents the Ground Balance setting, “GND BAL” will be displayed next to the number.

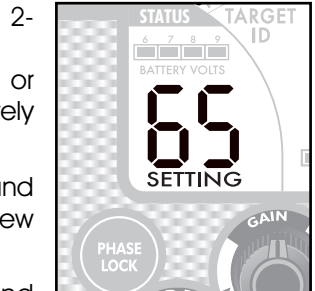

Setting Memory

The position of the **GAIN**, **THRESHOLD**, and **DISCRIM** control knobs always indicates the setting of these controls.

The **GND BAL** setting, as well as the **FREQ**, **TONES**, and **NOTCH** values, are not permanently saved to memory and will reset to default values when the detector is powered off.

GROUND BALANCING

What is Ground Balancing?

Why do I need to Ground Balance?

All soils contain minerals. Signals from ground minerals are often tens or hundreds of times as strong as the signal from a buried metal object. The magnetism of iron minerals, found in nearly all soils, causes one type of interfering signal. Dissolved mineral salts, found in some soils, are electrically conductive, causing another type of interfering signal.

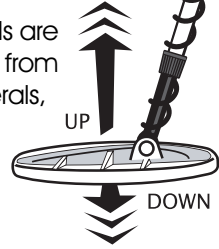

Ground Balancing is the process by which the metal detector cancels the unwanted signals coming from the ground minerals while still detecting the signals from buried metal objects. This is accomplished by matching the detector's ground balance setting to the phase of the ground signal.

When the detector is calibrated to the soil, the result will be deeper target detection and quieter operation.

How to Ground Balance your detector:

Ground Balancing procedure with the "Phase Lock" touchpad.

1. Turn the F5 on and select AM (All Metal) Mode.
2. Find a clear piece of ground with no metal present, using All Metal or Pinpoint Mode. (Note: Pinpoint preferred)
3. Set the threshold to a slight background hum. (Note: default setting of "0" is adequate)
4. Press and hold the Phase Lock touch pad, and pump coil over clean ground. (Note: pump coil from 1" off ground to 6-8" off ground)
5. When the phase value "settles down" to only one or two numbers in variation, release the Phase Lock touch pad while still pumping the coil. Note that the Audio Response to the ground changed and "EVENED OUT" when you released the button. Also note that the Gnd Bal setting changed to match the Phase Value, giving you a visual AND audio Ground Balance confirmation. After balancing, you can hunt in All Metal... or return to Disc Mode.

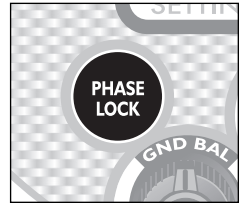

To maintain the best ground balance setting for your detector, the GND BAL setting on the left of the screen should always approximate the PHASE value on the right of the screen.

The most accurate PHASE value is the value displayed when "pumping" the coil over the ground in an area free of metal.

GROUND BALANCING – Technical Information

Understanding ground conditions assists the user in setting up the machine, knowing when to readjust ground balance, and in understanding the responses of the machine while searching. The Fisher F5 provides two kinds of ground data: 1. the amount of mineralization (the greater the amount of mineralization, the greater the loss of detection depth & ID accuracy; this loss is more pronounced in Discrimination Mode) 2. the type of mineralization (which affects mostly where the ground balance should be set).

Fe₃O₄ BAR GRAPH

The Fe₃O₄ 4-segment bar graph indicates the amount of ground mineralization, independent of type, expressed as an equivalent volume concentration of magnetite (Fe₃O₄). It updates every second. It is sensitive to motion and will give the most accurate readings if you “pump” the searchcoil up and down several times over the ground. The presence of metal or “hot rocks” will cause the readings to be inaccurate. If you stop moving the searchcoil, the bar graph will go blank.

INDICATION	% Fe ₃ O ₄	SUSCEPTIBILITY
H — HIGH	0.4 - 1.6	1,000 - 4,000
M — MEDIUM	0.1 - 0.4	250 - 1,000
L — LOW	0.025 - 0.1	60 - 250
VL — VERY LOW	0.006 - .025	15 - 60
none --	less than .006	less than 15

Magnetic susceptibility is expressed in micro-cgs units. In a salt water environment in the absence of iron minerals, the bar graph indicates relative electrical conductivity.

In soils with greater than 4,000 micro-cgs units magnetic susceptibility, the signal from the soil may saturate (“overload”) the circuits. This will not harm the detector but the machine will not be usable in that condition. The solution is to hold the searchcoil several inches above the soil surface so it isn’t “seeing as much dirt”. By listening and watching you will know how high you need to hold the searchcoil in order to avoid overload.

The highest magnetic susceptibilities are usually found in soils developed over igneous rocks, in alluvial “black sand” streaks on beaches, and in red clay soils of humid climates.

The lowest magnetic susceptibilities are usually found in white beach sands of tropical and subtropical regions, and soils developed over limestone.

PHASE

The phase readout at the bottom-right of the screen provides a two-digit 0 - 99 numeric indication of the magnetic “loss angle” of the soil minerals. The numerical scale is the same one used for ground

GROUND BALANCING –Technical Information *(continued)*

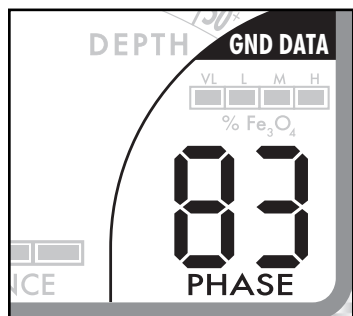

PHASE *continued*

balancing. When the phase readout (verified by pumping the coil over the ground) is indicating numbers which are consistently above or below your present ground balance setting (indicated on the lower left of the display), you will probably want to readjust your ground balance. This is especially important if you're operating in All Metal Mode.

The Phase readout requires that the searchcoil be in motion. The most repeatable measurements can be achieved by "pumping" the searchcoil up and down over the soil surface. The presence of metal or "hot rocks" will result in inaccurate readings. If motion of the searchcoil stops, the phase readout will produce meaningless readings.

The numeric scale does not indicate actual degrees, but rather the scaling of the signals used to balance the ground signal. These signals are scaled to give the greatest phase resolution in nonconductive soils high in magnetite, where the greatest resolution is needed.

INDICATION	COMMENTS
99	loss angle of -1.5 degrees upper limit of ferrite balance tolerance band
83	loss angle = 0 degrees; nominal ferrite balance
71	loss angle = 1.5 degrees lower limit of ferrite balance tolerance band
60	loss angle = 3.6 degrees
50	loss angle = 6.0 degrees
40	loss angle = 9.6 degrees
30	loss angle = 15.3 degrees
20	loss angle = 25.8 degrees
10	loss angle = 47 degrees
0	loss angle = 90 degrees

Electrical ferrite and magnetite (a naturally occurring form of ferrite) will usually read about 83. However, due to calibration drift due to time and temperature change, or the use of different search coils, ferrite may read anywhere within the total tolerance band of 71 to 99 without significant impairment of operation. Freshly weathered rocky soils and sands (other than white beach sand) will usually read higher than 65. Silt and loam soils will usually read above 55. Red clay soils will usually read above 45 but lower than 75. Soils reading between 10 and 45 are usually low in mineralization as indicated by the Fe_3O_4 bargraph, are usually electrically conductive, and are often high in smectite clays. Soils in the range of 0 to 10 are rarely encountered other than in a moist saline or alkali environment with little or no iron mineralization. White sands will usually give no reading.

AUDIO TARGET IDENTIFICATION SYSTEM

Different types of metals will induce different types of sounds, depending on your TONES setting.

There are 4 choices in DISCRIMINATION MODE:

- d1.** Medium-to-high pitch tone, varying in proportion to target signal strength. Large shallow objects will produce a squeal. The variable audio pitch provides you more information about the detected object. Volume and Pitch increase with increase in signal strength.

- d2.** Iron produces a low-pitch tone regardless signal strength. Volume varies in proportion to signal strength. Non-ferrous targets respond as in d1.

- d3.** Three different audio tones.
Low Tone: Iron
High Tone: Foil, 5¢, Tab and Zinc
Very High Tone: Dime, 25¢, and 50+

- d4.** Four Different audio tones
Low Tone: Iron
Medium Tone: Foil, Tab, and Zinc
High Tone: 5¢
Very High Tone: Dime, 25¢ and 50+

The default setting is d2.

To choose from the above selections, press the TONES touch pad. Each press of the TONES touch pad cycles to the next selection.

There are 4 choices in ALL METAL MODE

A1, A2, A3, A4 - pitch varies with each setting.

DEPTH AND TARGET DISPLAY

READING THE DISPLAY

The Liquid Crystal Display (LCD) shows the PROBABLE identification of the targeted metal, as well as the PROBABLE depth of the target, in inches.

The detector will normally register a repeating, unchanging target identification when a buried target has been located and identified. If, upon repeated passes over the same spot, the target identification reads inconsistently, the target is probably a trash item, oxidized metal, or too deep to be classified accurately. With practice, you will learn to unearth only the more repeatable signals.

The segment identifications are highly accurate when detecting the objects described on the screen. However, if you register in a given category for an unknown buried object, you could be detecting a metallic object other than the object described on the screen, but with the same metallic signature. Also, the greater the distance between the target and the coil, the less accurate the target identification.

GOLD TARGETS Gold objects will register on the left side of the LCD scale. Gold is categorized depending on its size. The smaller the gold object, the further to the left it will register.

Small gold items will register under Fe or Foil.

Medium-sized gold items will usually register under 5¢ or Tab.

Large gold items will usually register under Tab or Zinc.

SILVER TARGETS: Silver objects will normally register to the right of the scale, under Dime, Quarter, or 50+, depending on the size of the object. The larger the object, the farther to the right it will register.

IRON: Fe is the scientific designation for Iron. Most iron objects will fall into the Fe category. Very large iron objects like a manhole cover will usually fall into the 50+ category.

5¢: Nickels and most newer pull-tabs will register here.

TAB: Older pull-tabs and ring-pulls from beverage cans usually will register here. Many gold rings will also register here.

ZINC/1¢: Newer pennies (post-1982) will register here. Many non-U.S. coins will also register here.

Screw caps from glass bottles will register here. Large gold rings, like a class ring, could also register here.

DIME: Dimes and pre-1982 copper pennies will register here.

Caution: The target indications are visual references. Many other types of metal can fall under any one of these categories. While the F5 will eliminate or indicate the presence of most common trash items, it is impossible to accurately classify ALL buried objects.

DEPTH AND TARGET DISPLAY

Reading the display continued

DEPTH INDICATOR:

The Depth Indicator is calibrated for coin-sized objects. It indicates the probable depth of the target, in inches.

While holding the PinPoint touch pad, and passing over a metal object "depth" will appear next to the two-digit number in the middle of the screen.

TWO DIGIT TARGET INDICATOR

The Two-digit target indicator, in the middle of the LCD display, provides a specific target

value to help identify buried targets more accurately. With practice in the field, you will learn to associate target values with the probable identification of buried objects. The target value can vary each time the coil passes over the target, depending upon the angle of the object and the distance from the coil.

As a starting point, refer to the table below.

TARGET Readout

The table below lists some common approximate target value equivalents. With experience in the field, you will recognize many types of metal objects by their numeric value.

TYPICAL VALUE	POSSIBLE OBJECTS
0-15	Iron
20-24	Pull-Tab Tail (broken off), Aluminum Foil
30-32	Nickel, Old style pull tab
36-42	Pull-Tab (new style), Ring Pull
58-60	Zinc Penny
70	Dime & Copper Cent
80	Quarter
88	Half Dollar
92	Silver Dollar

UNDERSTANDING THE DISPLAY

Mode Indication

The search mode is briefly displayed in the center of the screen each time you change modes, as follows:

- AM All Metal
- d Discrimination
- PP Pinpoint



Target Categories

There are 8 categories, indicated at the top of the display.

When the searchcoil passes over a metal object in DISCRIMINATION or ALL METAL Mode, a rectangular-shaped icon will light up over the category which describes the metal object.

Discrimination Indicators

When a “—” appears over the target category descriptions, all of the targets in that category have been eliminated from detection. Rotate the DISCRIM knob to choose the discrimination setting.

Target-ID

A 2-digit number will appear when passing over a metal object in DISCRIMINATION or ALL METAL Mode. This 2-digit number corresponds to the target categories at the top of the display.

Depth

When holding the PINPOINT touch pad, the 2-digit number in the center of the display shows the distance to the object, in inches. This depth indicator is calibrated to coin-sized objects. If the buried object is other than a coin, the depth indicator provides a relative depth indication.

Confidence

While the Target-ID provides a target identification, it is not possible to always be 100% accurate of the buried object’s classification due to the large variety of buried metal objects. To assist with target identification refer to this confidence meter.

If the detector is highly confident an object’s classification, all 5 bars will illuminate.

One bar illuminated indicates a very low level of confidence in the target identification.

UNDERSTANDING THE DISPLAY *(continued)*

Battery Indicator

Segments indicate the battery voltage, as printed on the display.

% Fe₃O₄

This bar graph displays the magnetic mineralization factor, or magnetic susceptibility, of the soil. The depth to which objects can be accurately identified is strongly influenced by the magnetic susceptibility of the soil. High Fe₃O₄ values have a greater effect on detection depth in the Discrimination Mode than in the All Metal Mode. For the most accurate Fe₃O₄ reading, pump the searchcoil as though you were ground canceling.

The % of Fe₃O₄ ground minerals are displayed as follows:

- H – high
- M – medium
- L – low
- VL – very low

Phase

The two-digit PHASE number displayed on the screen indicates the type of ground mineralization. The number is continuously displayed in all detection modes except Pinpoint, and is continually updated. Ground conditions can change within a given search area, sometimes slowly, and sometimes quite abruptly. This number cannot be adjusted by the user.

Some typical ground mineralization types are:

- 0 – 10 Wet salt and alkali
- 5 – 25 Metallic iron
- 26 – 39 Very few soils in this range -- occasionally some saltwater beaches
- 40 – 75 Red, yellow, and brown iron-bearing clay minerals
- 75 – 95 Magnetite and other black iron minerals

Setting

This 2-digit number on the bottom-left of the display can represent any of the following:

- Internal Ground Balance setting (GND BAL): from 00 to 99
- Gain: 20 values from 5 to 99 in steps of 5
- Threshold: 19 values from -9 to 9
- Discrimination Setting: from 0 to 65
- Frequency: 1, 2, or 3
- Audio Tones Selection: d1, d2, d3, d4 or A1, A2, A3, A4

If the user is not moving any knobs or pressing any touchpads, then the number represents the internal ground balance setting, and "GND BAL" is illuminated.

"GND BAL" disappears when the user selects a control, and the SETTING then represents the current value for the activated knob or touch pad.

SEARCH TECHNIQUES (in DISC Mode)

Target Verification

After detecting a target, do the following:

1. Walk around the target in a circle.
2. While circling the target, continue sweeping the searchcoil across the target.
3. Sweep once every 30° or 40° of the circle.

If the tone does not change and the Target-ID value is consistent as you circle the target, you can be highly confident of the target's identification.

If the tone or Target-ID changes as you circle the target, you may have multiple targets or an irregularly shaped object.

If the tone completely disappears at different angles, the target may be trash or a low-value metal.

If you are new to the hobby, dig all targets. With practice in the field, you will soon identify audible and visual target feedback with certain types of metal objects.

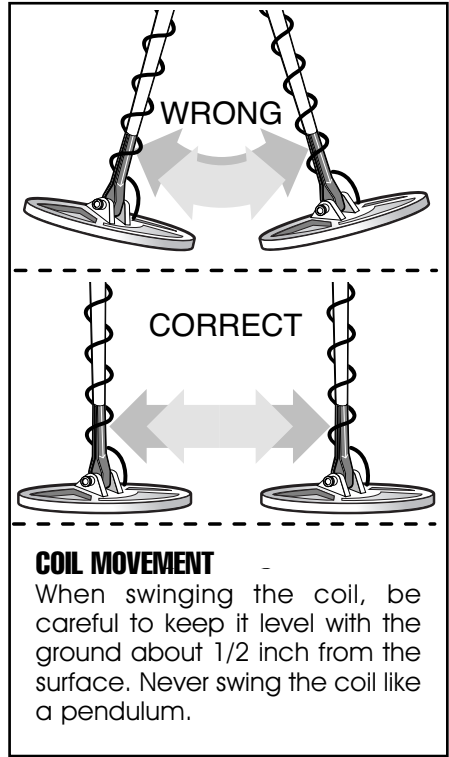

Pinpointing process in motion modes:

1. Sweep over target in narrowing side-to-side pattern.
2. Take visual note of spot on ground where "beep" occurs.
3. Step 90° to the side of the target.
4. Sweep coil over same area, at 90° to 1st sweep pattern.
5. This pinpoints the target location with an "X".

TARGET PINPOINTING *(in PINPOINT Mode)*

After you have identified a target using a motion mode of detection, press-and-hold the PINPOINT pad to identify the target's exact location. This technique can yield more information about the target's shape and size and also find its exact location to facilitate extraction.

Pinpoint as follows:

1. Position the searchcoil just barely off the ground, and to the side of the target.
2. Now move the searchcoil slowly across the target, and you can locate it by the sound. The target is located directly under where the sound is loudest.

Narrow It Down:

1. To narrow the response further, position the center of the searchcoil near the center of the response pattern, but not directly over the center.
2. Release the PINPOINT touch pad.
3. Press-and-hold PINPOINT pad again.
4. Repeat this narrowing procedure to narrow the field of detection further.

Note: Depth indication is less accurate after narrowing.

COIL DRIFT

If you plan to use the PINPOINT Mode for continuous searching, realize that drift will occur over time, causing the detector to gain or lose sensitivity. Periodic retuning of the detector is required to minimize drift; release and press PINPOINT again to retune.

TREASURE HUNTER'S CODE OF ETHICS:

- Always check Federal, State, County and local laws before searching.
- Respect private property and do not enter private property without the owner's permission.
- Take care to refill all holes and leave no damage.
- Remove and dispose of any and all trash and litter found.
- Appreciate and protect our inheritance of natural resources, wildlife and private property.
- Act as an ambassador for the hobby, use thoughtfulness, consideration and courtesy at all times.
- Never destroy historical or archaeological treasures.
- All treasure hunters may be judged by the example you set; always conduct yourself with courtesy and consideration of others

UNIT SPECIFICATIONS:

Mechanical: S-rod with electronics housing on rod, 3-piece breakdown construction, nonmetallic telescoping lower rod, adjustable position armrest

Weight: 3.0 lbs (1.38 kg) with batteries installed

Standard searchcoil: 10 inch (25 cm) open-frame elliptical concentric, waterproof

Batteries: two 9 volt rectangular alkaline (will run on one)

Operating principle: VLF induction balance

Operating frequency: nominal 7.8 kHz, microprocessor controlled
7731.9Hz, 7810Hz, 7888.1Hz

Basic sensitivity: 2.5×10^9 root Hertz (detectivity)

Lag coefficient: 92 milliseconds

Reactive overload: 5,000 micro-cgs (with standard searchcoil)

Resistive overload: 600 micro-cgs (with standard searchcoil)

Ground balance range: from ferrite to salt water inclusive

Discrimination ground suppression: combination of 2nd and 3rd order methods

Target-ID ground suppression: 3rd order

Battery life: 40+ hours on good quality alkalines

Operating temp range: 14 to 122 degrees F (-10 to +50 C)

Operating humidity range: 0 - 90% noncondensing

This device has been designed to operate with the antennas listed below, and having a maximum gain of 3 dB. Antennas not included in this list or having a gain greater than 3 dB are strictly prohibited for use with this device. The required antenna impedance is 43 ohms.

10COIL-F5, 11COIL-F5, 5COIL-F5

The following statement is not relevant to metal detectors but is printed here to satisfy legal notification requirement:

“To reduce potential radio interference to other users, the antenna type and its gain should be so chosen that the equivalent isotropically radiated power (e.i.r.p.) is not more than that permitted for successful communication.”

5-YEAR LIMITED WARRANTY

The F5 metal detector is warranted against defects in materials and workmanship under normal use for five years from the date of purchase to the original owner.

Damage due to neglect, accidental damage or misuse of this product is not covered under this warranty. Decisions regarding abuse or misuse of the detector are made solely at the discretion of the manufacturer.

Proof of Purchase is required to make a claim under this warranty.

Liability under this Warranty is limited to replacing or repairing, at our option, the metal detector returned, shipping cost prepaid to Fisher Labs. Shipping cost to Fisher Labs is the responsibility of the consumer.

To return your detector for service, please first contact Fisher Labs for a Return Authorization (RA) Number. Reference the RA number on your package and return the detector within 15 days of calling to:

Fisher Labs
1120 Alza Drive,
El Paso, TX 79907
Phone: 915-225-0333 ext.118
Fax: 915-225-0336

Warranty coverage does not include the cost of transporting the detector back to an owner who is located outside of the United States of America.

NOTE TO CUSTOMERS OUTSIDE THE U.S.A.

This warranty may vary in other countries, check with your distributor for details. Warranty does not cover shipping costs.

According to FCC part 15.21 Changes or Modifications made to this device not expressly approved by the party responsible for compliance could void the users authority to operate this equipment.

This device complies with FCC Part 15 Subpart B Section 15.109 Class B.

Copyright© 2019

All rights reserved, including the right to reproduce this book, or parts thereof, in any form.

Fisher® is a registered trademark of Fisher Research Labs

www.fisherlab.com

FISHER® RESEARCH
LABS

1120 Alza Drive, El Paso, TX 79907 • (915) 225-0333

Made in the USA from USA and imported parts.

ACCESSORIES

Fisher® Padded Carry Bag

Rugged double stitched construction. Includes handy exterior pocket for extra batteries or small accessories. 103693000C



Fisher® Camo Pouch

Camo pouch with two inside pockets, belt included. – PCH-F



Stereo Headphones

Use with Fisher® metal detectors. Lightweight and adjustable with true stereo sound, adjustable volume, 1/4 jack with 1/8 adaptor, 4' cable. – 9720950000



Metal Sand Scoop

Large galvanized metal scoop with filtering holes. Strong Rubberized grip. SAND SCOOP



Lesche Knife

Made from high quality heat-treated tempered steel. The ultimate digging tool. Comes with a durable sheath. 12" in length with a 7" serrated blade. LESCHE KNIFE



Fisher® Baseball Cap

One size fits all. – FCAP



Fisher® T-Shirt

100% cotton with Fisher® Logo. Sizes: S, M, LG, XL & XXL – FTSHIRT



Replacement/Accessory Searchcoils

10" Concentric Standard Coil (replacement) – 10COIL-F5F
5" Biaxial Accessory Coil – 5COIL-F5F
8" Concentric Accessory Coil – 8COIL-7B13F
11" Biaxial Accessory Coil – 11COIL-F5F

Coil Covers

Specially made to protect your coil from abrasion and damage.
10" Concentric Standard Coil Cover – F70COVER
5" Biaxial Accessory Coil Cover – 5COVER-CZ3
8" Concentric Accessory Coil Cover – 8COVER-7
11" Biaxial Accessory Coil Cover – COVER-11DD



Rain Cover

Neoprene rain cover specially made to protect your F5 from weather– RAINCOV-F5



FOR COMPLETE DETAILS VISIT WWW.FISHERLAB.COM • 1-800-685-5050