

TEKNETICS®

*eurotek*

METAL  
DETECTOR

**OWNER'S MANUAL**



Use a 9-volt **ALKALINE** battery only.  
Do not use "Heavy Duty" batteries.  
Do not use ordinary Zinc Carbon batteries.

# ***Congratulations!***

Congratulations on your purchase of the new Eurotek® Metal Detector. Eurotek® is the result of years of research and development to bring you a detector designed specifically for European Treasure Hunting conditions. Treasure Hunting enthusiasts from around the world were involved in the development of this revolutionary new detector. The Eurotek® has Target-ID resolution never before seen in a detector in this price range. Special iron identification and audio feedback features are an industry first. This manual has been written to help you get optimal use of your detector, so we hope you will read it thoroughly before your first outing.

*Happy Hunting from First Texas Products!*

## **TABLE OF CONTENTS**

---

Terminology .....	3
Assembly .....	4-5
Batteries .....	6
Quick-Start Demo .....	7
Basics of Metal Detecting	
Ground Minerals .....	8
Trash .....	8
Identifying Buried Objects .....	8
Size and Depth of Objects .....	8
Electromagnetic Interference .....	9
Headphones .....	9
Operation and Controls	
Power On and Work the Controls .....	10
Menu Selections	
Overview .....	11
Sensitivity .....	11
Discrimination .....	12
Discrimination System	
Target Detection .....	13
Target-ID .....	13
2-Tone System .....	13
Stance .....	14
Sweep .....	14
Depth Indicator .....	15
Coin Reference Table .....	15
Other Features	
Iron Identification .....	16
Pinpointing .....	16
Overload .....	17
Memory .....	17
Reset .....	17
Troubleshooting .....	18
Accessories .....	19
Code of Ethics & Warranty .....	20

# **TERMINOLOGY**

---

The following terms are used throughout the manual, and are standard terminology among detectorists.

## **ELIMINATION**

Reference to a metal being "eliminated" means that the detector will not emit a tone, nor display a Target-ID, when a metal object passes through the searchcoil's detection field.

## **DISCRIMINATION**

When the detector emits different tones for different types of metals, and when the detector "eliminates" certain metals, we refer to this as the detector "discriminating" among different types of metals.

Discrimination is an important feature of professional metal detectors. Discrimination allows the user to ignore trash and otherwise undesirable objects.

## **RELIC**

A relic is an object of interest by reason of its age or its association with the past. Many relics are made of iron, but can also be made of bronze or precious metals.

## **IRON**

Iron is a common, low-grade metal that is an undesirable target in certain metal detecting applications. Examples of undesirable iron objects are old cans, pipes, bolts and nails.

Sometimes, the desired target is made of iron. Property markers, for instance, contain iron. Valuable relics can also be composed of iron; cannon balls, old armaments and parts of old structures and vehicles can also be composed of iron.

## **FERROUS**

Metals which are made of, or contain, iron.

## **PINPOINTING**

Pinpointing is the process of finding the exact location of a buried object. Long-buried metals can appear exactly like the surrounding soil, and can therefore be very hard to isolate from the soil.

## **V.C.O.**

Meaning "voltage controlled oscillator," the V.C.O. audio method causes both the *audio pitch* and the *volume* to rise as signal strength increases. V.C.O. improves the user's ability to interpret a target's size and depth. Very weak signals (for small or very deeply buried objects) have the faintest volume and the lowest pitch. Larger objects, and those closer to the searchcoil, will induce a higher volume and higher pitch sound.

## **GROUND BALANCE**

Ground Balancing is the ability of the detector to ignore, or "see through," the earth's naturally occurring minerals, and only sound a tone when a metal object is detected. This detector incorporates proprietary circuitry to eliminate false signals from severe ground conditions.

# PRE-ASSEMBLY

Unpack your detector to find the following contents:



1. Control Housing

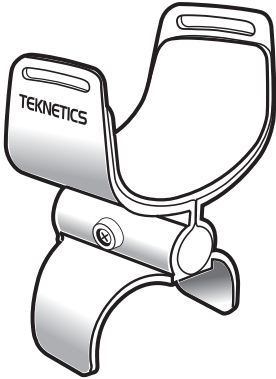

2. Armrest Assembly with  
Screw and Lock-Nut



3. Searchcoil

4. Middle  
Stem

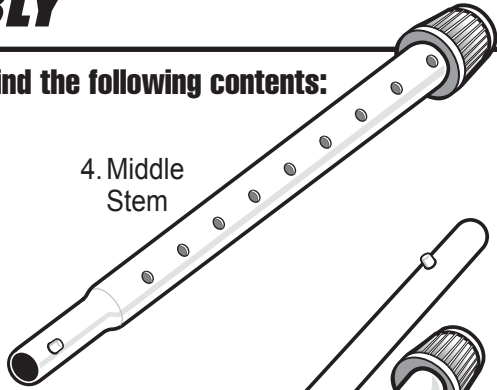

5. Lower Stem  
with Bolt &  
Knurled  
Knob  
attached

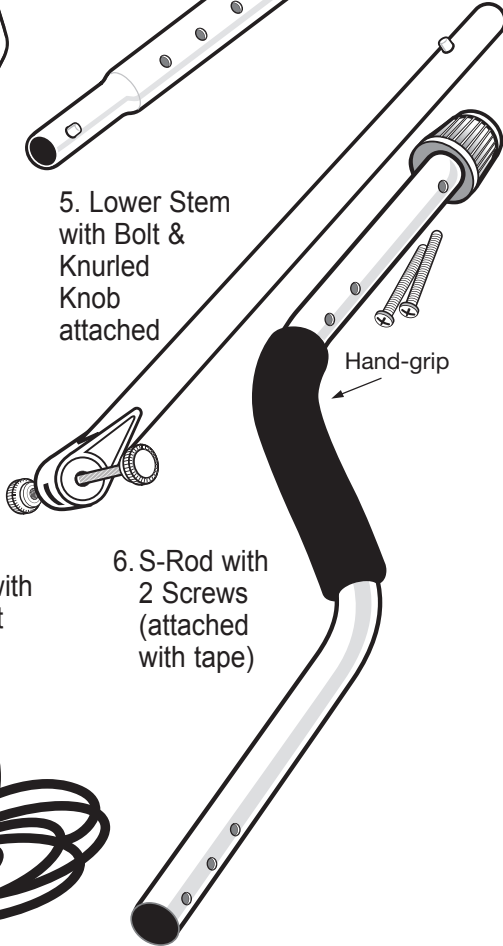

6. S-Rod with  
2 Screws  
(attached  
with tape)

Hand-grip

## Tool Required: #1 Phillips Screwdriver

1. • Remove the Screw from the Armrest.  
• Slide the Armrest over the end of the S-Rod.  
• Attach with Screw and Lock-Nut.
2. Attach Control Housing with 2 screws; install back screw first.

**NOTE:** The Hand-grip fits under the Control Housing.  
Peel back Hand-grip to expose the front hole.

# ASSEMBLY

**Caution:** Forcing in MIDDLE STEM with CAM LOCK raised may form a burr on camlock. If this happens, remove burr with knife to allow insertion.

- 1 Position S-Rod upright.
- 2 Rotate the LOCKING COLLAR fully in the counterclockwise direction.
- 3 Insert your finger inside the tube and make sure the INTERNAL CAM LOCK is flush with the inside of the tube.

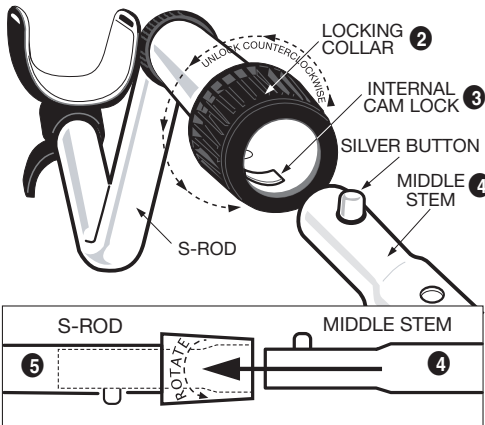

- 4 Insert the MIDDLE STEM into the S-ROD, with the SILVER BUTTON pointed upward.
- 5 Rotate the MIDDLE STEM until the SILVER BUTTON locates in the hole.
- 6 Twist the LOCKING COLLAR fully in the clockwise direction until it locks.
- 7 Repeat this process on the LOWER STEM.
- 8 Using the BOLT and KNURLED KNOB, attach the SEARCHCOIL to the LOWER STEM.
- 9 Adjust the LOWER STEM to a length that lets you maintain a comfortable upright posture, with your arm relaxed at your side, and the SEARCHCOIL parallel to the ground in front of you.
- 10 Wind the CABLE securely around the STEMS, leaving slack at the bottom.
- 11 Insert the plug into the matching connector on the back of the detector body. Be sure that the key-way and pins line up correctly.
- 12 Tighten both LOCKING COLLARS.

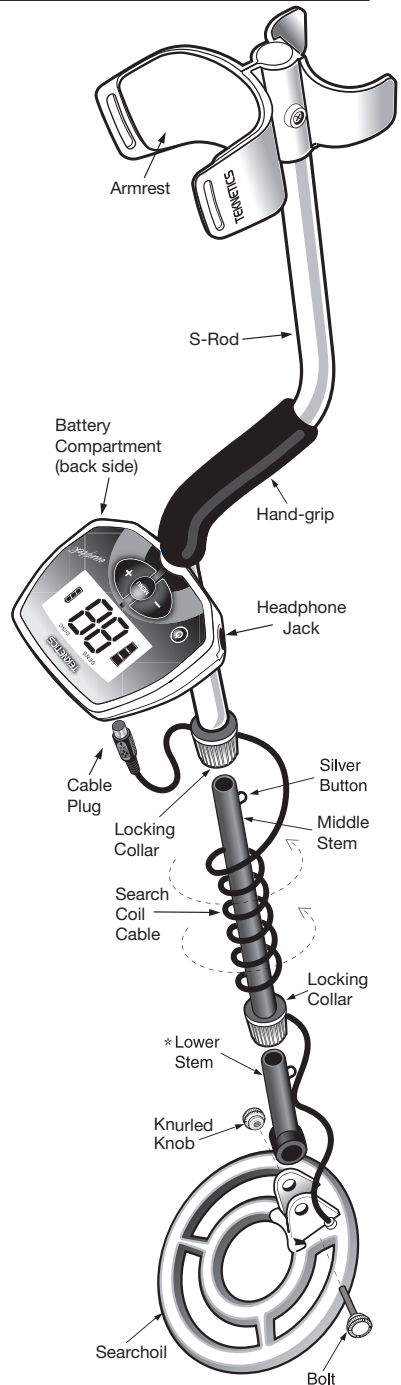

\* Note: Very tall users can purchase the optional Extended Lower Stem (TUBE5X), for extended reach.

# BATTERIES

The detector requires a single 9-volt **ALKALINE** battery (battery not included).

**Do not use ordinary Zinc Carbon batteries.**

**Do not use “Heavy Duty” batteries.**

Rechargeable batteries can also be used.

If you wish to use rechargeable batteries, we recommend using a Nickel Metal Hydride rechargeable battery.

The battery compartment is located on the back side of the housing.

Slide the battery door to the side and remove it to expose the battery compartment.

For easy battery removal, push down firmly on the bottom of the battery (see illustration).

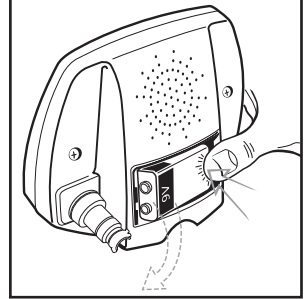

## BATTERY LIFE

Expect 20 to 25 hours of life from a 9-volt alkaline battery.

Rechargeable batteries provide about 8 hours of usage per charge.

## BATTERY INDICATOR

The battery icon on the right of the display has three vertical segments and an outline segment.

The amount of battery voltage for an ALKALINE battery is indicated as follows:



3 vertical segments illuminated: 8.1 volts or more

2 vertical segments illuminated: 7.1 to 8.0 volts

1 vertical segment illuminated: 6.5 to 7.0 volts

No vertical segments illuminated: 6.2 to 6.4 volts

Outline Flashing: 6.1 volts or less

## SPEAKER VOLUME AND BATTERY CHARGE

You may notice the speaker volume drop while one battery segment is illuminated. With the outline flashing, low speaker volume will be very apparent.

## BATTERY DISPOSAL & RECYCLING

Alkaline batteries may be disposed of in a normal waste receptacle or recycled. Non-Alkaline batteries should be recycled. In the state of California all battery types must be recycled. Please refer to local municipalities for detailed disposal and recycling requirements.

## Armrest Strap (optional accessory)

The strap is available for purchase as a separate accessory. Some users prefer to use the strap when swinging the detector vigorously in order to hold the detector secure against the arm.

The detector can also be used without the strap, with no compromise to detector balance and stability under most conditions.

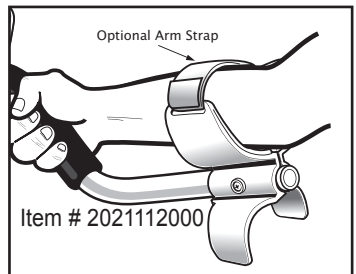

# QUICK-START DEMONSTRATION

---

## I. Supplies Needed

- a Nail
- a Gold Ring (try several different size gold rings)
- a Large Silver Coin

## II. Position the Detector

- Place the detector on a table, with the searchcoil hanging over the edge. Or better, have a friend hold the detector, with the searchcoil off the ground.
- Keep the searchcoil away from walls, floors and metal objects.
- Remove watches, rings and jewelry.
- Turn off lights or appliances, whose electromagnetic emissions may cause interference.
- Pivot the searchcoil back.

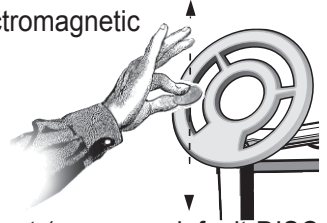

## III. Power Up

Press .



## IV. Wave each object over the searchcoil

- Notice the tones and Target-IDs for each object (assumes default DISC setting):

OBJECT	TARGET-ID	STONE
Nail	lower (e.g. 10-35)	V.C.O.
Gold Ring	medium (e.g.- Mid 50's)	V.C.O.
Larger Gold Ring	medium (but higher than ID for smaller gold ring)	V.C.O.
Silver Coin	higher (e.g.- 80-99)	High

- Motion is required.
  - Objects must be in motion over the searchcoil to be detected.
  - Sweep objects flat over the searchcoil, parallel to the plane of the searchcoil.

## V. Press twice to activate the DISC selection

- While sweeping the Nail back-and-forth, press  to increase the DISC setting.
- Continue to press  and increase the DISC setting.
  - Notice that the Nail is eliminated from detection when the DISC setting is equal to the target's ID.

**Caution:** Passing the nail at differing angles will yield different ID numbers.

## VI. Repeat Step V while waiving the Gold Ring, and then also while waiving the Silver Coin

# ***THE BASICS OF METAL DETECTING***

---

This metal detector is intended for locating buried metal objects. When searching for metals, underground or on the surface, you have the following challenges and objectives:

1. Ignoring signals caused by ground minerals.
2. Ignoring signals caused by metal objects that you do not want to find, like nails.
3. Identifying a buried metal object before you dig it up.
4. Estimating the size and depth of objects, to facilitate digging them up.
5. Eliminating the effects of electromagnetic interference from other electronic devices.

Your metal detector is designed with these things in mind.

## **1. Ground Minerals**

All soils contain minerals. Signals from ground minerals can interfere with the signals from metal objects you want to find. All soils differ, and can differ greatly, in the type and amount of ground minerals present. The Eurotek® has a preset ground elimination setting. No user adjustments are required.

## **2. Trash**

If searching for coins, you want to ignore items like aluminum foil and nails. You can see the Target-ID value of the buried objects, listen to the sounds, and then decide what you want to dig up. Or you can eliminate unwanted metals from detection by using the DISCRIMINATION feature.

## **3. Identifying Buried Objects**

Metal objects are identified by a 2-digit number on the display screen. This scale has 99 points of resolution, and is an indicator of the relative electrical conductivity of different objects. Higher numbers indicate more conductive targets. Iron objects, which are usually of lesser value, display lower numbers. Silver coins, for instance, usually display the highest numbers.

## **4. Size and Depth of Buried Objects**

The 3-digit bar graph indicates the relative depth of a buried metal object. This bar graph can indicate the relative size of different objects or their distance from the searchcoil. For a given object, the more distance between it and the searchcoil, the more bars illuminated.



# **THE BASICS OF METAL DETECTING**

---

## **5. EMI (Electromagnetic Interference)**

The searchcoil produces a magnetic field and then detects changes in that magnetic field caused by the presence of metal objects. This magnetic field that the detector creates is also susceptible to the electromagnetic energy produced by other electronic devices. Cell phones, cell phone towers, power lines, microwave ovens, lighting fixtures, TVs, computers, motors, etc... all produce EMI which can interfere with the detector and cause it to beep when no metal is present, and sometimes to beep erratically.

The SENSITIVITY control lets you reduce the strength of this magnetic field, and therefore lessen its susceptibility to EMI. You may want to operate at maximum strength, but the presence of EMI may make this impossible, so if you experience erratic behavior or “false” signals, **reduce the sensitivity.**

---

## **HEADPHONE JACK**

This detector has a 1/4” headphone jack.

It works with any stereo headphone that has a 1/4” plug.

When the headphone jack is connected, speaker volume is disabled.

## **USING HEADPHONES**

Using a detector with headphones facilitates detection of the weakest signals and also extends the battery life.

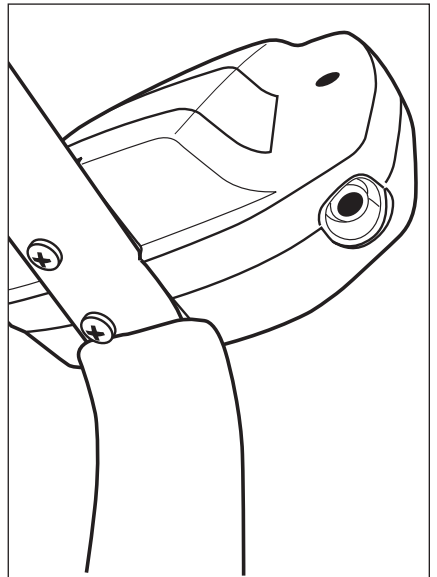

It also allows you to hear subtle changes in the sound more clearly, particularly if searching in a noisy location. For safety reasons, do not use headphones near traffic or where other dangers are present. This device is to be used with interconnecting cables/headphone cables shorter than three meters.

# OPERATION and CONTROLS

## POWERING UP

**NOTE:** Immediately after powering on, your detector's unique 10-digit serial number is displayed once on the LCD. Two digits are displayed at a time; five 2-digit numbers are displayed in sequence. This 10-digit serial number is the same serial number imprinted on the label inside the battery compartment.

Press  The detector powers on.

A “” appears momentarily, indicating that the detector is in the Discrimination Mode of operation.

All targets are detected. Motion is required.

Default sensitivity is 7, on scale of 1 to 10.

Default discrimination is 0, on scale of 0 to 79.

## HOW TO WORK THE CONTROLS

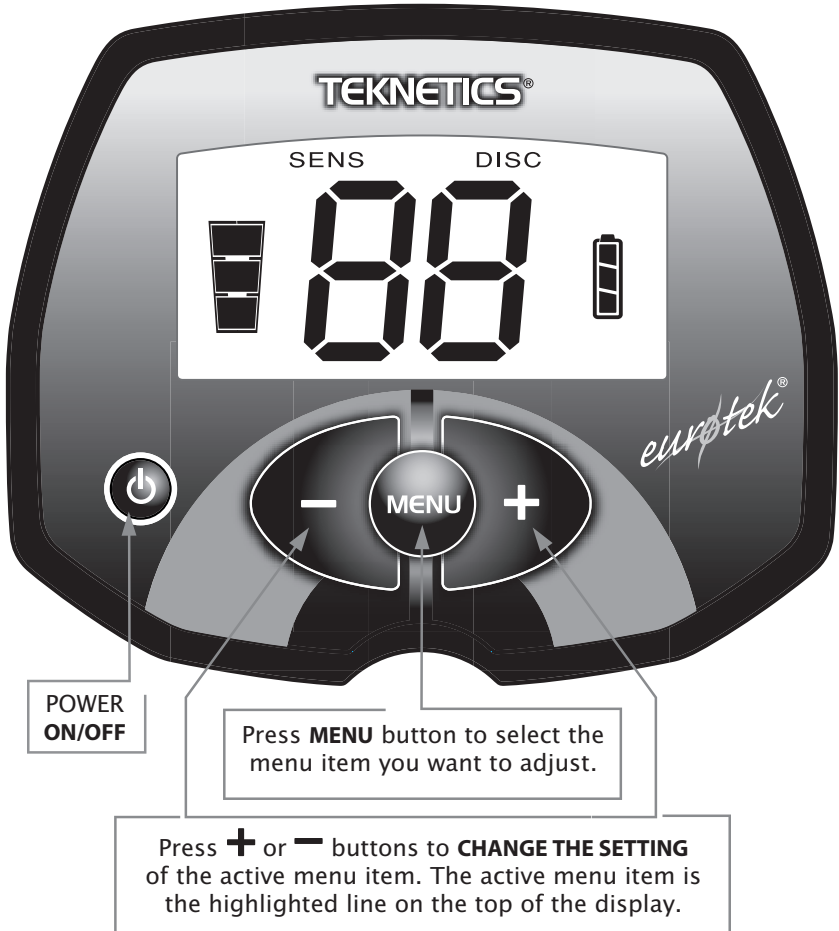

# MENU SELECTIONS

---

## Operational Overview



Press  to activate the menu system: SENS or DISC.

At first activation of the menu system, the SENS menu selection appears.

Successive presses of  will toggle to DISC and then back.

With a menu selection visible, press  or  to change settings for that menu selection.

When you reach the desired setting, as indicated by the 2-digit value on the display, no further action is necessary.

- 4 seconds after the last  or  key-press, the menu icon will time-out and the last displayed setting will be programmed in.
- Or press  again before the display times out, and advance to the next menu selection; the last displayed setting will be programmed in.

During operation, recall the last menu selection by pressing MENU at any time; the last menu selection adjusted will again be displayed.

While the MENU display is active, the LCD display will not respond to targets, but the audio target system will continue to respond to any target or overload signal.

## 1. SENS (Sensitivity)

Press  to illuminate the SENS menu icon.

Use  and  to increase or decrease sensitivity while SENS is highlighted.

Maximum sensitivity setting is 10.

Minimum sensitivity setting is 1.

If the detector beeps erratically or beeps when there are no metal objects being detected, **reduce the sensitivity.**

The searchcoil produces a magnetic field and then detects changes in that magnetic field caused by the presence of metal objects. This magnetic field that the detector creates is also susceptible to the electromagnetic energy produced by other electronic devices. Cell phones, cell phone towers, power lines, microwave ovens, lighting fixtures, TVs, computers, motors, etc.... all produce EMI which can interfere with the detector and cause it to beep when no metal is present, and sometimes to beep erratically.

# MENU SELECTIONS

---

## HOW DEEP WILL IT GO?

The Eurotek® Metal Detector will detect a coin-sized object to a distance of about 20 cm (8") from the searchcoil at maximum sensitivity. Large metal objects can be detected to a depth of more than a meter. Detectability is directly related to the size of the metal object -- the larger the object, the deeper it can be detected.

Accuracy of target identification is also related to distance from the searchcoil. Targets on the fringe of detection will have less accurate Target-IDs than targets closer to the searchcoil.

## 2. DISC (Discrimination)

The DISC control allows the user to eliminate a range of targets from detection. The user selects a 2-digit number; targets less than or equal to this setting will not be detected.

Be aware that some irregular targets, and targets on the fringe of the detectable range, may induce different Target-ID numbers on subsequent passes. As such, it may be possible that a target intended for elimination may not always be eliminated.

Press  to illuminate the DISC menu icon.

With each press of  or , the DISC setting changes by one.

Press-and-Hold  or  to rapidly advance or reduce the DISC setting.

---



**Bulgarian 10  
stotinkas, 1999**



**Bulgarian 50  
stotinkas,  
1999 - 2007**



**Peter I, 1705,  
Silver, 0.25 gr.**



**Mikhail  
Fedorovich,  
1613-1645**



**50 kopeek  
Nikolay II, 1896,  
Silver**



**5 kopeek,  
Ekaterina II, 1781**



**2 kopeek,  
Alexander I, 1816**



**10 ct Napoleon III  
(bronze, France)**

# DISCRIMINATION SYSTEM

## Target Detection

Sweep the detector back-and-forth over the ground.

Keep the searchcoil parallel to the ground as you sweep; do not lift the searchcoil at the ends of your sweeps.

Searchcoil motion is required for target detection.

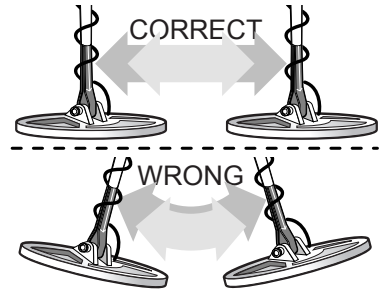

## Target-ID

When objects are detected, the detector will emit a sound and a 2-digit Target-ID will appear on the screen. Possible Target-IDs range from 1 to 99. This number represents the electrical conductivity of the target detected; higher numbers indicate more highly conductive targets.

The 2-digit number indicates the Target-ID of the last object detected. The Eurotek® has a very fast target response and is able to detect different objects in very close proximity. Therefore, the Target-ID displayed may change rapidly as you sweep the searchcoil.

Three seconds after the last Target-ID is displayed, the Target-ID will time-out and the number will disappear.

As a general reference, targets fall into the following ranges:

- 1 - 39 : iron
- 42 - 48 : foil and small gold nuggets
- 54 - 57 : gold nuggets, gold rings or targets containing mostly gold
- 87 - 89 : clad coins or coins of recent vintage
- 82 - 83 : copper coins
- 93 - 99 : larger silver coins

**Note:** There are a wide variety of metals and no target can be identified for certain until unearthed. This table is for general reference only.

See the table on P. 15 for a more complete listing of Target-ID values for common metal items.

## 2-Tone System

Depending on the type of metal detected, and the DISC setting of the detector, a buried metal object will induce one of the following audio responses:

**No sound:** metals eliminated from detection (or discriminated-out), with the DISC function.

**V.C.O. (variable pitch and volume):** targets with an ID less than 70.

**High Tone:** all targets with an ID of 70 or greater.

The Target-ID system and the Audio-ID systems on the Eurotek® operate independently. Therefore, there may be times when the tones and IDs seem inconsistent. For example, a very deeply buried target may induce a low tone, but the signal may be too weak for the visual ID system to determine, with confidence, a reliable Target-ID number. In this case, the detector may not register a visual Target-ID, even after the detector has emitted a tone.

# ***IN-THE-FIELD TECHNIQUES***

---

## **STANCE**

Stand with your arm extended in front of your body. Don't bend or stoop; stand in a comfortable position. Hold the unit so that the searchcoil is about 3cm above the ground. Adjust the searchcoil so that it is parallel to the ground.

## **SWEEP**

Standing in the search position, swing the searchcoil gently from side to side, slightly overlapping each sweep as you move forward. Keep your searchcoil approximately 3cm above the ground as you search. Raising it during the sweep, or at the ends of your sweep, can cause false readings. Move slowly; hurrying will cause you to miss targets.

Most desirable objects will respond with a repeatable tone. When discriminating, iron and foil objects are generally eliminated from detection. False signals can be caused by trashy ground, electrical interference or by large irregular trash objects. These signals are easily recognized by their often broken or non-repeatable nature.



*1/4 of Stater,  
gold, France*



*2 Franc Morlon,  
aluminum*



*Medieval double  
sol*



*50cent Chambre  
du Commerce*



*Double  
Tournois,  
copper*



*Roman  
Nummus,  
bronze*



*Celtic Potin,  
mixed metal*



*Merovingian  
Triens, gold*

# DEPTH INDICATOR

In Discrimination Mode, each time an object is detected, a Bar Graph illuminates in addition to the Target-ID.

The Bar Graph is a graphic representation of the distance from the searchcoil, and is calibrated to a coin-sized object.

- More bars indicate a deeper object.
- Fewer bars indicate a shallower object.

The scale for coin-sized objects, with sensitivity at maximum, is:

Display:



Depth:

>15cm  
(6")\*

8cm-15cm  
(3"-6")

<8cm  
(3")\*\*

\* 3 Bars: If the object is a coin, it is more deeply buried.

...or this could be the faint signal from a large, but very deeply buried, object.

\*\* 1 Bar: If the object is a coin, it is shallow.

...or this could be a large object deeply buried.

**Target-ID Coin Reference.** Below are known Target-IDs for some reference coins:

Merovingian Triens (gold, France)	42	Russian Scale Mikhail Fedorovich, 1613-1645, Silver, 0.625 gr.	65
Polish Zloty (Pre-WWII) 0.20 zl (1923 nickel)	44-99	Bulgarian 5 stotinkas (old) (CuAlNi)	68-73
Celtic Potin (copper-lead)	52	Bulgarian 1 lev	69-73
Polish Zloty 0.50PLN	54-56	10 Euro Cent	70-74
USSR 50 kopeck, 1980, Nickel, D 24 mm.	56	1 Euro Coin	70-78
Russian Scale Peter I, 1705, Silver, 0.25 gr.	56-57	Medieval double sol coin (France)	75
Polish Zloty 1PLN	56-57	20 Euro Cent	76-78
US Nickel	56-57	50 Euro Cent	76-80
Polish Zloty PRL 100zl (CuNi)	58-59	Double Tournois (copper, France)	78
Bulgarian 1 stotinkas, 1999 (CuAlNi)	58-64	British £1	79-80
Bulgarian 10 stotinkas, 1999	59-60	Polish Zloty PRL .20 zl (aluminum)	80
Bulgarian 50 stotinkas, 1999,2004,2005,2007	59-65	10 ct Napoleon III (bronze, France)	80
Roman Nummus (bronze)	60	British £2	81
1/4 of Stater (gold, France)	60	2 Franc Morlon (Aluminum, France)	82
50cent Chambre du Commerce (France)	60	US Dime	84-85
Bulgarian 2 stotinkas, 1999 (CuAlNi)	60-64	Polish Zloty (Pre-WWII) 2zl (1933 silver)	86-87
Polish Zloty 5PLN	61	US Quarter	88-90
2 Euro Coin	62-66	Russian, 50 kopeck Nikolay II,1896, Silver, D 27 mm.	93-94
Polish Zloty '0.05PLN	63-64	US Silver Dollar	94-95
British 20p	64-65	Russian, 2 kopeck, Alexander I, 1816, Copper, D 30 mm.	94-95
Polish Zloty 2PLN	64-65	Russian, 1 ruble Nikolay II,1896, Silver, D 34 mm.	98
USSR, 5 kopeck, 1961, Bronze, D 25 mm.	65	Russian, 5 kopeck, Ekaterina II, 1781, Copper, D 41 mm.	99

# OTHER FEATURES

---

## IRON IDENTIFICATION

### Variable Iron Identification & Discrimination

The Eurotek® allows the user not only to discriminate iron targets, but classifies them by size and signal strength. Ferrous objects will have a Target-ID between 1 and 39.

To eliminate all ferrous objects from detection, set DISC = 39.

## PINPOINTING

*Accurate pinpointing takes practice and is best accomplished by “X-ing” the target area.*

- ➊ Once a buried target is identified by a good tone response, continue sweeping the coil over the target in a narrowing side to side pattern.
- ➋ Take visual note of the place on the ground where the “beep” occurs as you move the coil slowly from side to side.
- ➌ Stop the coil directly over this spot on the ground.
- ➍ Now move the coil straight forward and straight back towards you a couple of times.
- ➎ Again make visual note of the spot on the ground at which the “beep” occurs.
- ➏ If needed, “X” the target at different angles to “zero in” on the exact spot on the ground at which the “beep” occurs.

**REMEMBER:** The detector will beep just as the center of the searchcoil passes directly over the buried object.

If you have difficulty pinpointing very strong signals, try lifting the coil higher off the ground until a weaker, but more concise, signal is heard. For very weak signals, try moving the coil in short quick sweeps, closer to the ground.

### Consider Purchasing a Pinpointer

When you kneel down to unearth an object, you may find it frustrating as the object can appear exactly like the surrounding soil. You may hold the object in your hand, and find it necessary to pass a handful of dirt over the searchcoil to see if it contains metal. An easier way is to use a handheld pinpointer. It is a probe-like device which is poked into the ground, making close up pinpointing a snap, reducing digging time, and minimizing the size of the holes you will dig. Teknetics® offers a robust and inexpensive pinpointer designed for this purpose.



# OTHER FEATURES

---

## OVERLOAD WARNING

If a metal object or highly magnetic soil are too close to the searchcoil, the detector will “overload.”



“ — — ” will appear on the screen and the detector will make a rapid, repeating mid-tone warning sound.

Overload will not harm the detector, but the detector will not function under these conditions.

Raise the searchcoil to search at a greater distance, or move to a different location.

## MEMORY



To store the current settings (SENS and DISC):

1. Start with the detector turned ON.
2. Select all desired settings.
3. Press-and-hold  for 8 seconds.
4. When the two menu selections appear at the top of the screen, release .

When you turn the detector ON for future use, your detector will resume operation with your programmed settings.

## RESET

To return all detector settings to the factory defaults:

1. Start with the detector turned OFF.
2. Press-and-hold .
3. Press .
4. Release .

The 2-digit number displayed is the software revision number.

# TROUBLESHOOTING

TROUBLESHOOTING GUIDE		
SYMPTOM	CAUSE	SOLUTION
Detector chatters or beeps erratically	<ul style="list-style-type: none"> <li>• Using detector indoors</li> <li>• Using detector near power lines</li> <li>• Using 2 detectors in close proximity</li> <li>• Highly oxidized buried object</li> <li>• Environmental electromagnetic interference</li> </ul>	<ul style="list-style-type: none"> <li>• Use detector outdoors only</li> <li>• Move away from power lines</li> <li>• Keep 2 detectors at least 6 meters (20') apart</li> <li>• Only dig up repeatable signals</li> <li>• Reduce sensitivity until erratic signals cease</li> </ul>
Constant low tone or constant repeating tones	<ul style="list-style-type: none"> <li>• Discharged battery</li> <li>• Wrong type of battery</li> </ul>	<ul style="list-style-type: none"> <li>• Replace battery</li> <li>• Use only 9V <b>alkaline</b> battery</li> </ul>
LCD does not lock on to one Target-ID or detector emits multiple tones	<ul style="list-style-type: none"> <li>• Multiple targets present</li> <li>• Highly oxidized target</li> <li>• Sensitivity set too high</li> </ul>	<ul style="list-style-type: none"> <li>• Move coil slowly at different angles</li> <li>• Reduce sensitivity</li> </ul>
No power, no sounds	<ul style="list-style-type: none"> <li>• Dead battery</li> <li>• Cord not connected securely</li> </ul>	<ul style="list-style-type: none"> <li>• Replace battery</li> <li>• Check connections</li> </ul>

**Note:** This equipment has been tested and found to comply with the limits for a Class B digital device, pursuant to part 15 of the FCC Rules. These limits are designed to provide reasonable protection against harmful interference in a residential installation. This equipment generates uses and can radiate radio frequency energy and, if not installed and used in accordance with the instructions, may cause harmful interference to radio communications. However, there is no guarantee that interference will not occur in a particular installation. If this equipment does cause harmful interference to radio or television reception, which can be determined by turning the equipment off and on, the user is encouraged to try to correct the interference by one or more of the following measures:

- Reorient or relocate the receiving antenna.
- Increase the separation between the equipment and receiver.
- Consult the dealer or an experienced radio/TV technician for help.

**CE** The manufacturer declares that the minimum ESD performance criteria is 1) the unit shall not be permanently damaged and 2) operator intervention is allowed.

This product meets the requirements of Industry Canada: CAN ICES-3 B/NMB-3 B.

# ACCESSORIES

## Teknetics® Padded Carrying Bag

Made of rugged double-stitched nylon construction. Includes handy outside zip-pocket for extra batteries or small accessories. –CBAG-T

## Teknetics® Camo Pouch

Camo pouch with two inside pockets, belt included. –PCH-T

## Teknetics® Stereo Headphones

Lightweight and adjustable headphones with true stereo sound, dual adjustable volume, 1/4" jack, 1/8" adapter and a 4' coiled cable. –HEADT

## Arm Strap

Secure your detector to your arm for a perfect swing – 202112000

## Teknetics® Pinpointer

Pinpoints the exact location of buried metal objects. Audio signal indicator and vibrator. No assembly required, runs on (1) 9-Volt Battery (not included). –PINPOINTER

## Digging Trowel

One-piece stainless steel construction with depth gauge –TROWEL-2

## Gold Pick

Tempered steel head is 10" long and the edge is 3 1/4" wide. The overall length is 19" with a durable fiberglass handle and a rubberized hand grip. Includes a powerful magnet attached to the head to quickly discriminate iron targets and magnetic hot rocks. –GOLD-PICK

## Lesche Knife

Made from high quality heat-treated tempered steel. The ultimate digging tool. Comes with a durable sheath.

12" in length with a 7" serrated blade –LESCHÉ KNIFE

## Eurotek® T-Shirt

100% cotton with Eurotek® Logo. Sizes S, M, LG, XL & XXL –ETPSHIRT

## Eurotek® Baseball Cap

One size fits all –ETPCAP

## Rain Cover

Custom made to protect from weather –RAINCOV-ET

## Extended Lower Stem

For taller users –TUBE5X (image not shown)

## Replacement & Accessory Searchcoils and Protective Covers

### Searchcoil Item#

### Description

5COIL-TEKB	Searchcoil, 5"DD Round, closed
8COIL-7B13 *	Searchcoil, 8" Concentric, open
10COIL-TEKB	Searchcoil, 10" Concentric, open
11COIL-TEKB	Searchcoil, 11"DD Ellipse, open

\* standard with detector

### Protective Cover Item#

5COVER-CZ3
8COVER-7
F70COVER
COVER-11DD

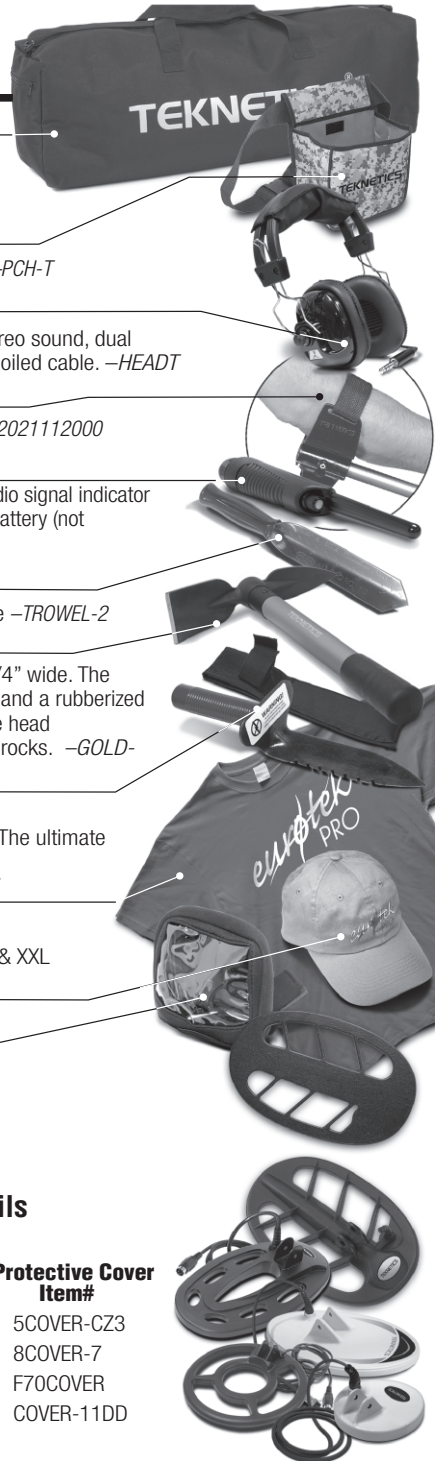

## TREASURE HUNTER'S CODE OF ETHICS:

- Always check Federal, State, County and local laws before searching.
- Respect private property and do not enter private property without the owner's permission.
- Take care to refill all holes and leave no damage.
- Remove and dispose of any and all trash and litter found.
- Appreciate and protect our inheritance of natural resources, wildlife and private property.
- Act as an ambassador for all treasure hunters; use thoughtfulness, consideration and courtesy at all times.
- Never destroy historical or archaeological treasures.
- All treasure hunters may be judged by the example you set; always conduct yourself with courtesy and consideration of others.

## ***5-YEAR LIMITED WARRANTY***

---

The **Eurotek**® metal detector is warranted against defects in materials and workmanship under normal use for five years from the date of purchase to the original owner.

Damage due to neglect, accidental damage or misuse of this product is not covered under this warranty. Decisions regarding abuse or misuse of the detector are made solely at the discretion of the manufacturer.

**Proof of Purchase is required to make a claim under this warranty.**

Liability under this Warranty is limited to replacing or repairing, at our option, the metal detector returned, shipping cost prepaid, to First Texas Products. Shipping cost to First Texas Products is the responsibility of the consumer.

To return your detector for service, please first contact First Texas Products for a Return Authorization (RA) Number. Reference the RA number on your package and return the detector within 15 days of calling to:

### **First Texas Products L.L.C.**

1120 Alza Drive  
El Paso, TX 79907  
Phone: 915-633-8354

### **NOTICE TO CUSTOMERS OUTSIDE THE U.S.A.**

This warranty may vary in other countries; check with your distributor for details.  
Warranty does not cover shipping costs to and from the U.S.A.

According to FCC part 15.21, changes or modifications made to this device not expressly approved by the party responsible for compliance could void the user's authority to operate this equipment.  
This device complies with FCC Part 15 Subpart B Section 15.109 Class B.

Copyright© 2020 by First Texas Products, L.L.C.

All rights reserved, including the right to reproduce this book, or parts thereof, in any form, except for the inclusion of brief quotations in a review.

Published by First Texas Products, L.L.C.

Operational Weight: 1.077 kg (2lbs. 5.5oz)

# **TEKNETICS®**

1120 Alza Drive • El Paso, TX 79907 • (915) 633-8354

[www.tekneticsdirect.com](http://www.tekneticsdirect.com)