



DV5 SERIES
DV-525DS Dual-Zone Wine Fridge

User Manual



Define Excellence

Thank you very much for choosing DIVIN wine fridge to store your precious collections! We hope you may enjoy using it.

Delivery Date: _____

*The delivery date is the date when the warranty begins.

Serial Number: _____

*The serial number is located on the data plate, which can be found on the inner wall of the wine fridge. Please write down your serial number in the blank.

General Instructions Before Usage

For safety and a better user experience, please read all instructions before using this product and retain the user manual for future reference.

- This appliance is not intended for children, please pay attention to their safety.
- To ensure the cooling system may function properly, after this wine fridge has been laid down during transportation and delivered, allow it to rest unplugged in a standing position (with the base situated on the floor) for at least 24 hours before turning on for use.
- Check the conditions of the product and take photos as you are receiving it from the delivery company. Inform them immediately when noticing any damages caused during transportation.
- Install the appliance only on a sturdy, flat, and level surface and be cautious during the installation at all times.
- Keep any packaging materials if needed for the future and keep them away from children.
- Make sure your power supply sources have met all the electrical standards required by laws. **DO NOT** use extension cords; use an exclusive and properly installed outlet instead.
- When stacking wine bottles, stack up to a maximum of 2 layers.
- To avoid the risk of tipping over, please only pull out one shelf with bottles at a time, especially when the wine fridge is still very empty.

Further assistance from DIVIN

Website-Support: <https://divinwinefridges.com.au/support/>

E-mail: info@divinwinefridges.com.au

Tel: 0484 308 208

Business Hours: 7:30-16:00 (Mon.-Thu.) | 7:30-14:00 (Fri.)

Table of Contents

General Instructions Before Usage.....	1
Important Safeguards & Warnings.....	3
Installation.....	5
The Touch Controls and Operation.....	6
Temperature Setting & Energy Saving Recommendations.....	7
Wine Rack & Bottle Configurations.....	8
Bottle Capacity.....	11
Care and Maintenance.....	12
Troubleshooting Guide.....	13
Warranty and Terms.....	15

Important Safeguards & Warnings

- All the instructions of this user manual must be read and adhered carefully to ensure safety, proper performance of the product, and the validity of DIVIN's warranty.
- This wine fridge is designed for commercial and residential indoor environments (excluding garages and other places that can have extreme temperature shifts) only for storing a wide variety of wines. If the wine fridge is used for purposes other than wine storage and causing damages to the unit directly, then we cannot provide full warranty.
- It is ideal for the appliance to operate in an indoor space that is between 5°C-35°C. If the temperature is much higher and lower than this range, the normal operation will be affected and the temperature of the wine fridge may be unstable or may not reach the desired temperature.
- **DO NOT** place the wine fridge near any heat sources (e.g. gas stoves, heaters, etc.) and in direct sunlight.
- Wine fridges with compressors are not noiseless and may produce different sounds when in use. Therefore, it is not recommended to install them in bedrooms.
- To avoid electric shock, **DO NOT** use the wine fridge or wire plug near wet locations. Also, **DO NOT** operate the product with wet hands.
- Extension cords are not recommended. Use a separate outlet that complies with the safety regulations. Never unplug the unit by pulling on the power cord. Always grasp the plug firmly and pull straight out from the outlet.
- The surfaces of the wine fridge may become heated temporarily due to the operation of the refrigeration system. **DO NOT** touch the heated surfaces. When the cooling process stops, the heated surfaces will start to cool down.

Note: The heated surfaces may help reduce the chance of condensation on the surfaces of the wine fridge and door frame.

- It is recommended to use a soft cloth and soap water to clean the wine fridge before use. **DO NOT** use flammable liquids to clean the unit to avoid fire hazard or explosion, especially when there is a fire source around (e.g. a gas stove in operation).

- When cleaning, **DO NOT** spray any cleaning chemicals around the front exhaust openings and the back of the appliance. This can avoid damages to the metal pipes that are around the compressor. When damages happen, refrigerant may leak and eventually cause the malfunction of the cooling system.
- Keeping the interior and exterior of your wine fridge clean and tidy and avoiding any spillage of wines inside the unit.
- When stop using the product for a long time, open the door to ventilate to avoid excessive moisture staying inside the unit. After that, lock the door to prevent children from being injured.
- Make sure the environment, where the appliance is used, is well-ventilated and the front exhaust openings are not blocked by any objects that may prevent proper air circulation.
- The wine fridge is equipped with an auto defrost system. **DO NOT** use other methods to speed up the defrosting process.
- When relocating the unit, remove the wines stored inside first to reduce the weight.
- The warranty applies only to the wine fridge itself and does not cover the stored items.
- If you wish to dispose of this product, please send it to an authorized large electrical recycling facility.

Installation

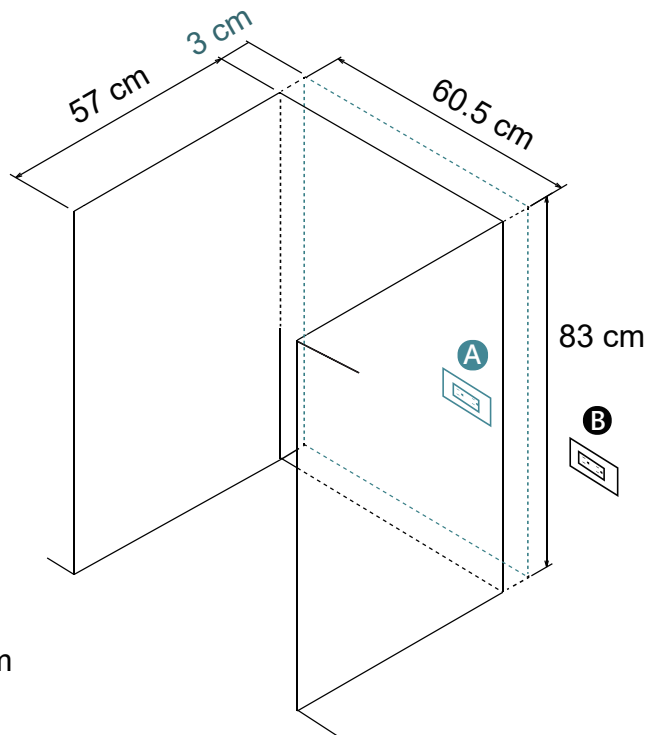
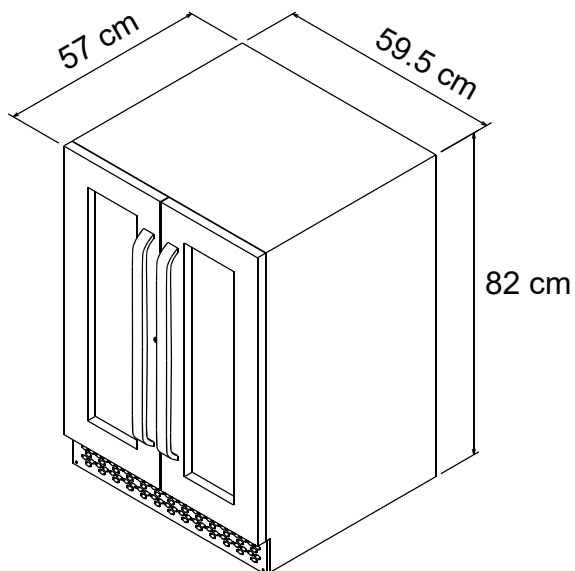
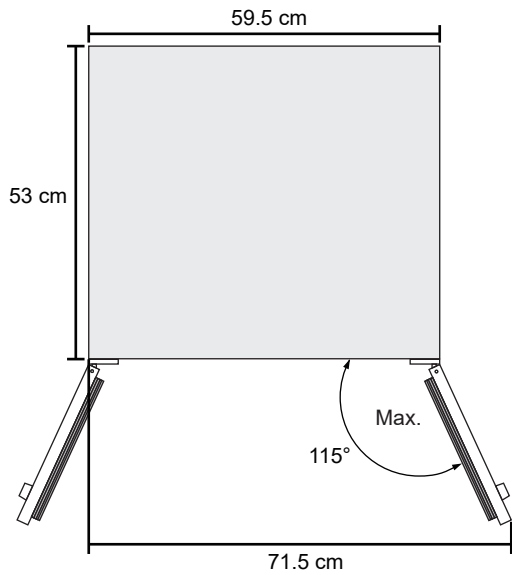

*Reserve 3cm extra distance only when the power outlet is right behind the wine fridge.

*The reserved built-in space does not include the projection of the handles (4.3cm).

The Touch Controls and Operation



There are 2 touch control panels in each temperature zone (the left and right cabinets), which operate separately when adjusting temperature settings.

NOTE: Just a gentle touch is required to activate multiple settings from the touch control panels.



Power On/Off
LED Light On/Off

Turning on/off the unit:

Touch the Power button once and hold for about 3 seconds for turning on the unit. Repeat again until seeing a “3, 2, 1” countdown to turn off the unit.

NOTE: The countdown is designed for preventing turning the unit off accidentally.

Turning on/off the LED lights:

Touch the Power button once to turn on and touch once to turn off.



Temperature Setting
Celsius/Fahrenheit Conversion

Setting a desired temperature:

Before touching the Temperature button, the temperature shows on the screen represents the current temperature of the cabinet. By touching it once, the number that starts to flash represents the current set temperature. While it is still flashing, touch again and again to start adjusting the temperature and stop touching when seeing the temperature that you would like to set to.

NOTE: The temperature setting remains the same after a power outage and the unit will turn on by itself and operate according to the previous temperature setting.

Celsius/Fahrenheit Conversion:

Touch the Temperature button once and hold for about 3 seconds to convert from Celsius to Fahrenheit. Repeat again for changing it back.

H H High/Low Temperature Alarm L L

When the temperature of the wine fridge is over 23°C or lower than 0°C, an alarm with beeps will begin, which will stop once the temperature is lower than 23°C or higher than 0°C.

NOTE: The alarm can be deactivated by pressing any buttons on the control panels.

Temperature Setting & Energy Saving Recommendations

Temperature Setting Tips:

The temperature of the wine fridge can be set to accommodate your wine collections and storage requirements. If your collections include age-worthy and ready-to-drink wines, we recommend to designate the left cabinet for ready-to-drink and the right cabinet for maturation or vice versa. The best temperature for maturing wines is around 12-14°C.

NOTE: Lower temperatures (12-14°C) are better for achieving ideal maturation at a normal rate, while high temperatures will speed up the maturation process, but do not necessarily result in good results.

The temperature of the ready-to-drink cabinet can be set according to the serving temperature of the type of wines that are stored in that cabinet. In general, the ideal serving temperature for red wine is anywhere between 15-18°C; 10-14°C for whites and rosés; 6-8°C for dessert wines; 5-10°C for sparkling wines. However, the actual optimal serving temperature depends on the characteristics of the wine (wine body, vintage, whether it has been aged in oak barrels, etc.). Therefore, please refer to the recommendations provided by wineries for the ideal serving temperature of their wines.

Energy Saving Tips:

- Install the wine fridge in a cool and ventilated area and away from any heat sources (e.g. sun light, ovens, less insulated spaces, etc.).
- Avoid opening the doors frequently or for too long.
- Set the temperature around 12-14°C for both temperature zones (the left and right cabinets); not only is it more energy saving, but also helps store any wines for a long term and serves whites and rosés at the same time.
- Set the two temperature zones at the same temperature.

Wine Shelves & Bottle Configurations

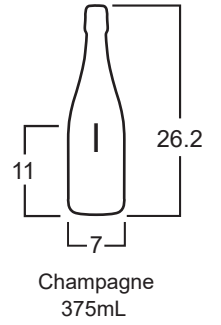
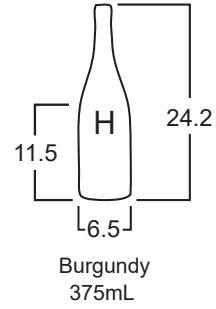
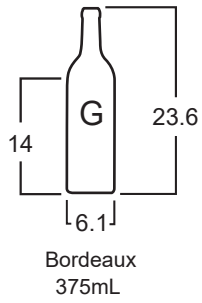
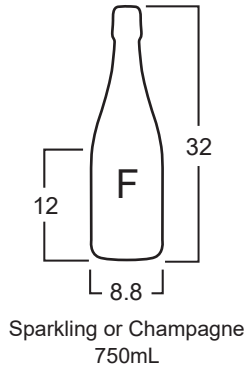
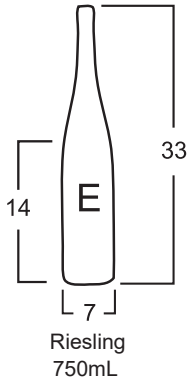
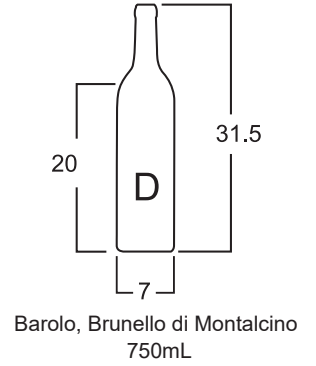
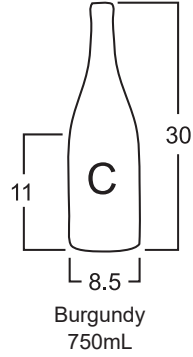
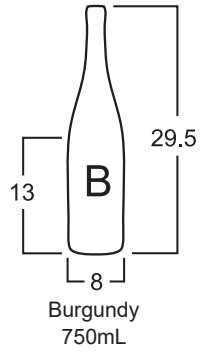
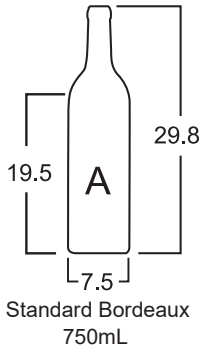

Unit: cm

Detachable Beechwood Shelves

*When taking/placing bigger bottles on a beechwood shelf, raise up the shelf that is right above it for easier access.

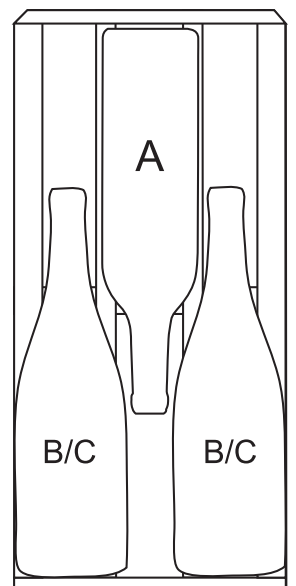
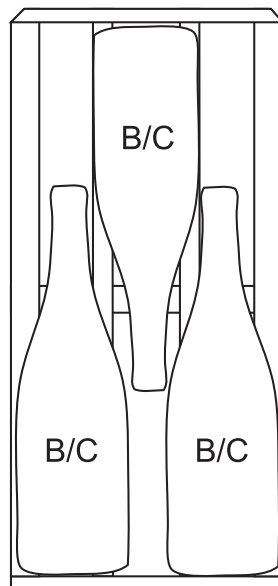
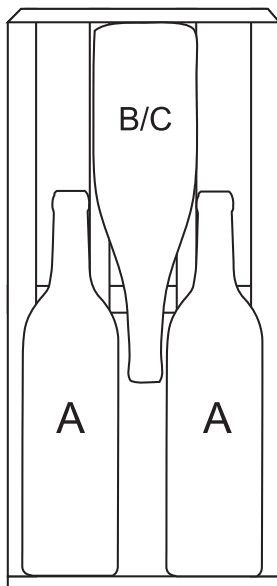
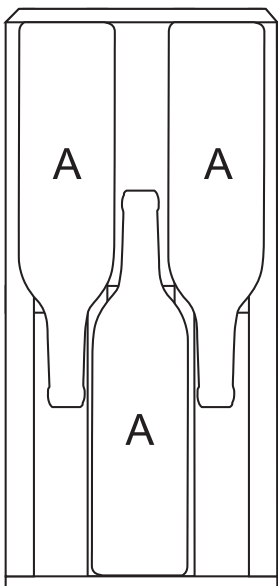

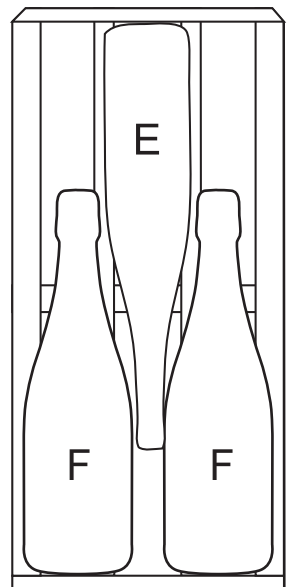
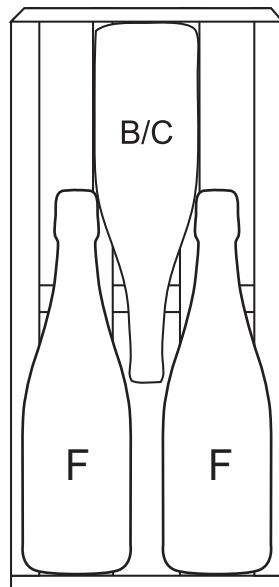
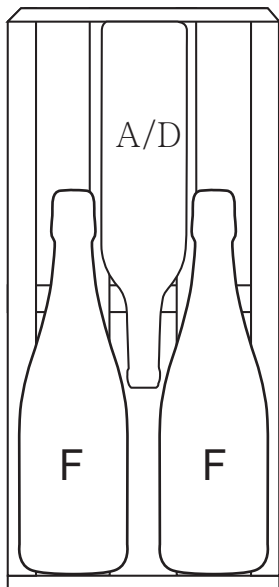
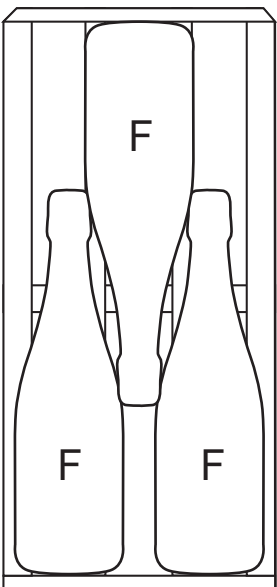
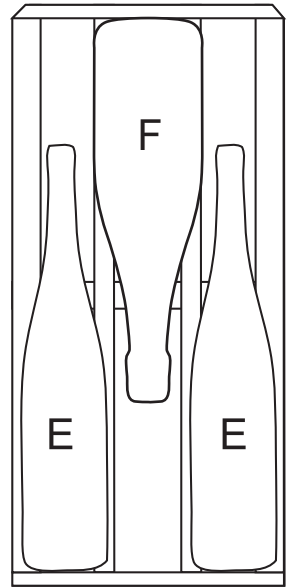
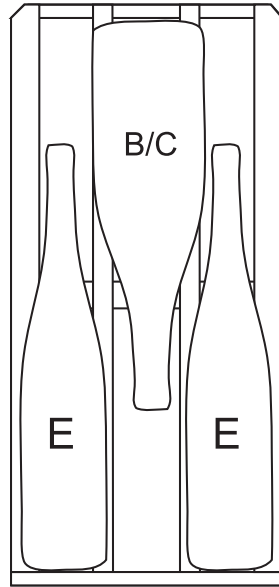
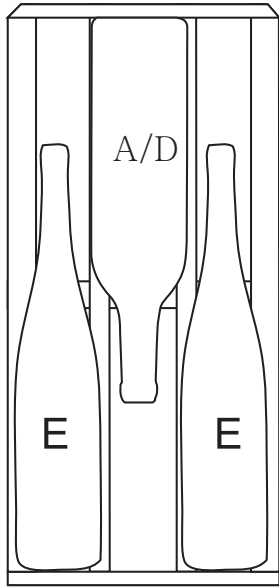
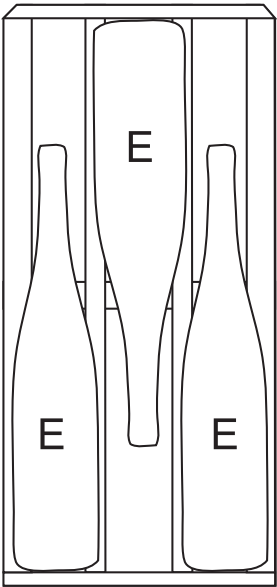
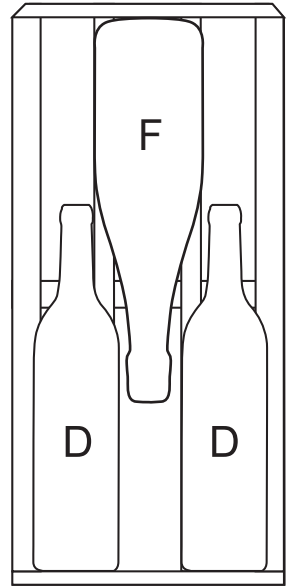
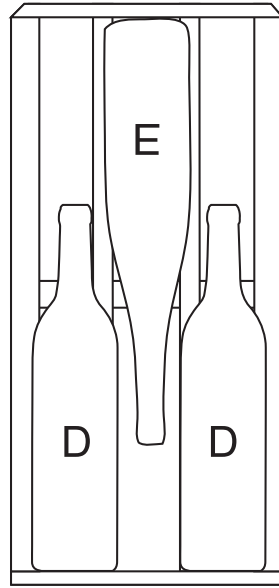
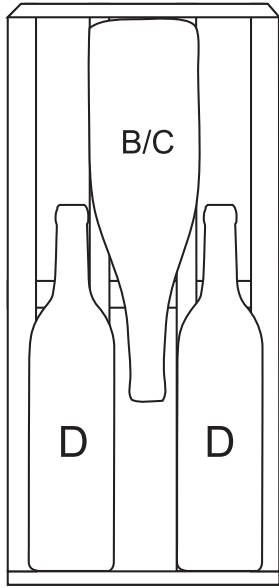
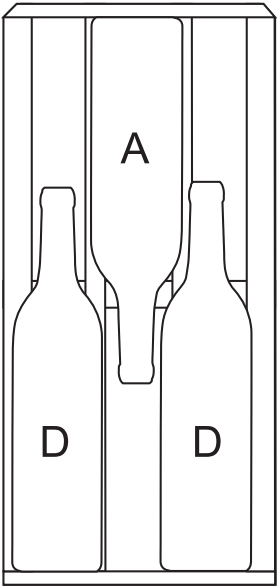

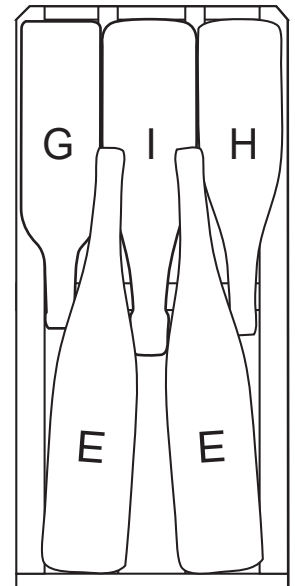
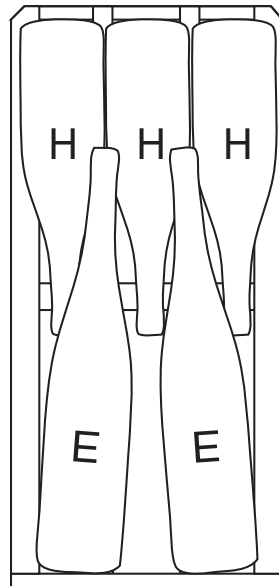
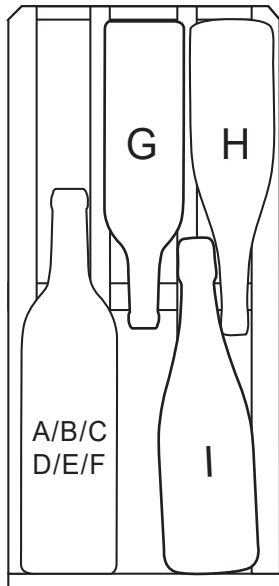
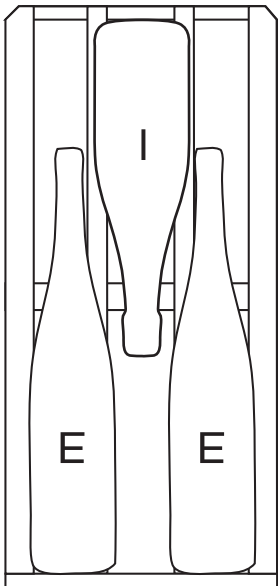
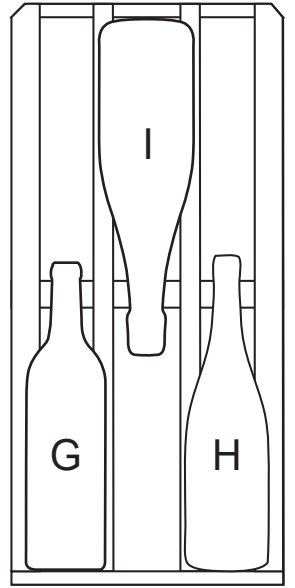
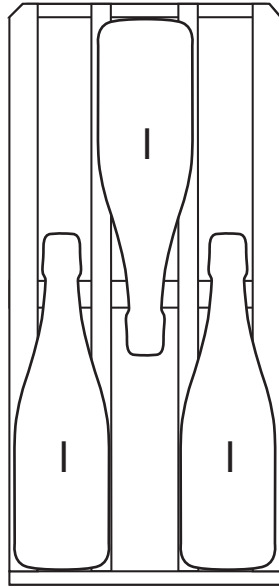
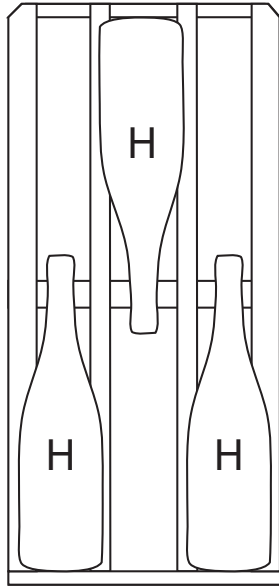
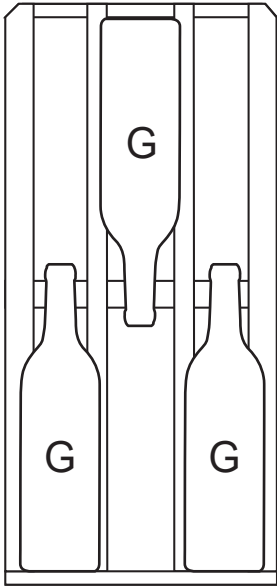

Fixed Shelves

*The max. bottle height is around 30cm.

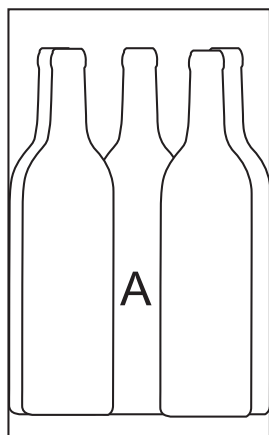

5 Standard Bordeaux
(750mL)

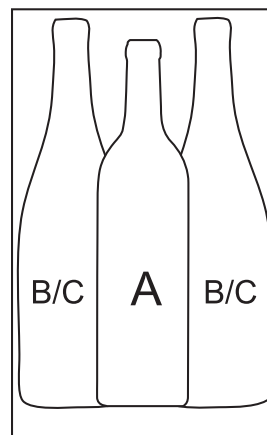

Diverse wine storage

Bottle Capacity

According to the industry standard, the total storage capacity of 40 bottles are measured based on the standard Bordeaux bottle 750mL.

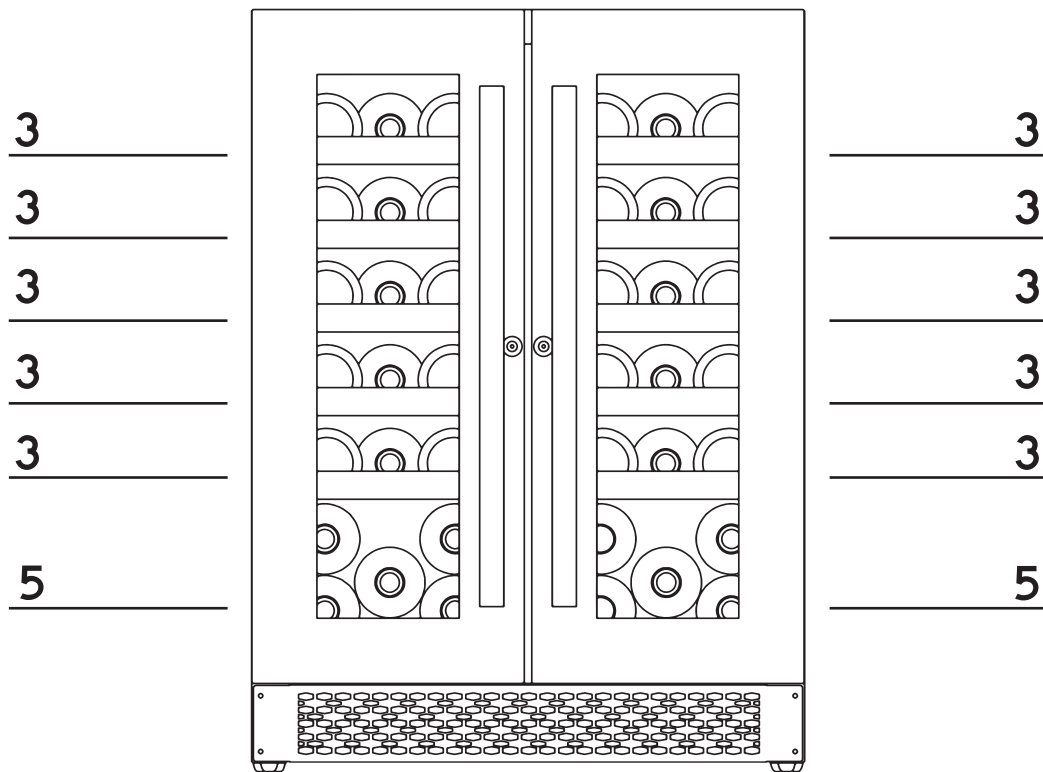

**Total Capacity: 40 bottles
(standard 750mL Bordeaux)**

Care and Maintenance

- Please keep the interior and exterior of your wine fridge clean and tidy to avoid any spillage of wine in the fridge. If there's any spillage please clean up with clean rags as soon as possible.
- **Glass Doors:**
We recommend using alcohol wipes, glass cleaning cloths, and also glass cleaner to wipe and clean the outer layer. However, we do not recommend wiping the inner layer. This can avoid the smell of the cleaning solution remaining inside the fridge and affecting the wine collection.
- **Stainless Steel Door Frames, Shelf Trims, and Front Exhaust Grill:**
We recommend using stainless steel cleaner to wipe them clean. (Please try out the cleaning products first on small areas first.)

Note: Stainless steel is not a material that is completely free from rusting. Regular cleaning and caring can prevent rust caused by grease and moisture.
- **Activated Charcoal Filter:**
We recommend replacing your filter once every year. Replacement frequency is based on the condition of your environment. For example, we recommend increasing the frequency of replacement in heavy oil fumes environments.

Troubleshooting Guide

Problems	Possible Causes & Solutions
Wine fridge does not operate	<ul style="list-style-type: none"> ● Check if the unit is plugged into a working power outlet. ● Try turning on the unit (refer to p. 6) after connecting to a working outlet. ● The circuit breaker is tripped or the fuse is blown. Call a professional electrician for help.
Not cold enough	<ul style="list-style-type: none"> ● It takes some time for the wine fridge to cool down after it has just been turned on. Also, the air inside cools down faster than the wines. ● Check to see if the set temperature is too high. ● The doors may have been opened frequently or for an extended period of time so it is losing cold air. ● The doors are not fully closed. ● The sealing strip is not fully sealed and leaving gaps in between the doors. Use a hair dryer to heat up around the unsealed parts of the strip to bring back its original shape.
LED lights are not working	<ul style="list-style-type: none"> ● Make sure the unit is plugged into a working outlet. ● Select the correct Lights On/Off button. Touch it once to turn on and touch again to turn off. ● The LED lights are burned out and need to be replaced. ● The circuit breaker is tripped or the fuse is blown.
Noise	<ul style="list-style-type: none"> ● Wine fridges are not noiseless products and may produce different sounds when in use, which does not affect the operation of the unit. ● The compressor makes noises when operating for the cooling process and it stops when the temperature reaches the set temperature. ● When the refrigerant is flowing through the piping it can generate the sound of a water stream. Sometimes the sound may vary due to the internal structure of the wine fridges. ● The fans inside the wine fridge can create a fan noise when operating.

<p>The doors cannot be shut properly</p>	<ul style="list-style-type: none"> ● Check to see if the door were tilted. ● Wine fridge doors are not properly installed ● Check whether the set temperature is too high ● Problems with door sealing strips (such as magnetic losses, deformation, etc.) ● The shelf is not pushed in all the way and causes the doors to propped open.
<p>The control panels are showing higher or lower temperatures than the set temperatures</p>	<ul style="list-style-type: none"> ● How the compressor works is that it operates as the current temperature of the wine fridge is higher than the set temperature and stops operation when the current temperatures drops below the set temperature.
<p>Compressor runs too frequently when...</p>	<ul style="list-style-type: none"> ● The wine fridge just turned on. ● The indoor temperature is too high. ● Just put in a large amount of wines. ● Doors may have been opened frequently or for an extended period of time.
<p>How to deal with power outage?</p>	<ul style="list-style-type: none"> ● In case of power outage, please do not open the door to prevent the temperature from rising due to the loss of cool air inside the wine fridge. DIVIN wine fridge is equipped with a temperature memory feature, which will automatically restore the temperature setting to that before the power outage. ● Most power outages will be restored within a few hours and will not affect the temperature of your wine fridge as long as you leave the doors closed. If you are still worried about power outages lasting a long period time, you can seek advice from a professional electrician to install an uninterruptible power supply (UPS).

Warranty & Terms

The warranty of DIVIN wine fridges includes 2-year warranty for the products (except for consumables like the activated charcoal filters) and 3-year for compressor (except for solenoid valves) from purchase date. Any faulty parts will be repaired and/or replaced at no charge under warranty conditions, due to manufacturing faults, which do not extend to negligence or misuse caused by the users.

Terms and Conditions:

- All the instructions of this user manual must be read and adhered carefully to ensure safety, proper performance of the product, and the validity of DIVIN's warranty.
- Once the warranty period expires, there will be charges for parts replacement, service, and maintenance fee, according to the price list. Substitute part will be used for repair when the replacement part is not available.
- Once the damage is caused by improper use of the wine fridge within the warranty period, we will quote extra charges for inspection service and traveling fees.
- Once it is determined by our engineer, which is not covered by the warranty within the warranty period, repairs will begin only if the client agrees with the quotation and charges.
- Please provide the serial number and have invoice/sales confirmation ready when booking an onsite service.
- The warranty is only available in Australia.

Warranty Disclaimer (the warranty does not cover the following):

- Defective product, provided by the client, is determined not to be the products of Global.
- Defective products with expired warranty.
- Damages caused by unauthorized disassembly and reassembly, improper care and maintenance, or any usage not described in the Operation Manual.
- Defective product from improper source or illegal acquisition.
- Product not purchased from DIVIN Australia or authorized distributors.
- Wear, scratch, stain, and deformation on appearance due to human factors.
- Damage caused by using device or accessory, which is not conforming to specifications.

- Consumables: e.g. activated charcoal filters.
- Loss of any wine or other products, stored in the DIVIN wine fridges, due to compressor failure.
- Damages caused by acts of God, pest and rat Infestation, or inadequate power supply.
- Influenced by the special environment, which is high-corrosion areas, such as brimstone area, high salinity coastal zone, marsh gas, chemical corrosion or on a boat.
- Non-functional damages as a result of user's expectation, audio frequency, volume, etc.
- Warranty certificate is damaged, lost, altered, or illegible.
- Warranty covers only the wine fridge itself, not the contents of preservation.
- Any other possible risks that client should bear in the use of the wine fridge, such as change in temperature or moisture, cork leak, fire, flood, mildew, corruption of content, desiccation, etc.



DIVIN

Define Excellence