

AlgoLaser **Delta**

# QUICK START GUIDE

Laser Engraver

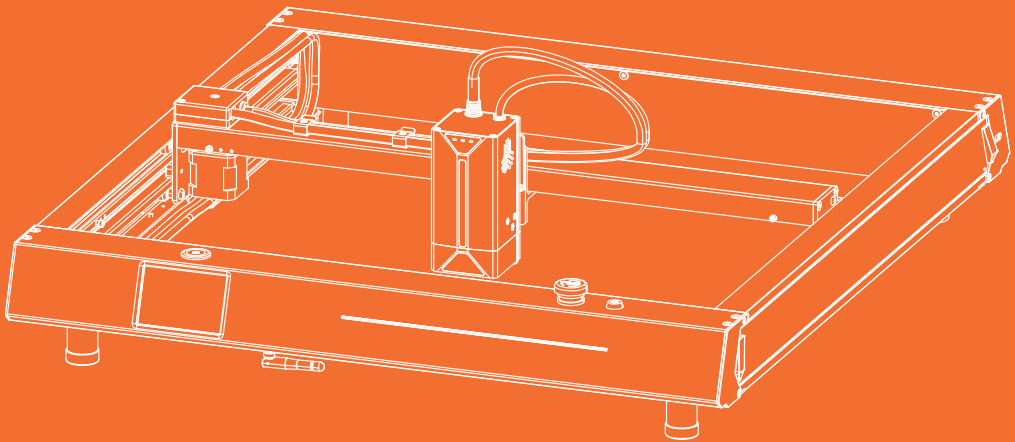

Always read the instructions before you start.



# CONTENTS

---

01  
**Before You Start**

02  
**Machine Assembly**

03  
**How to Use**

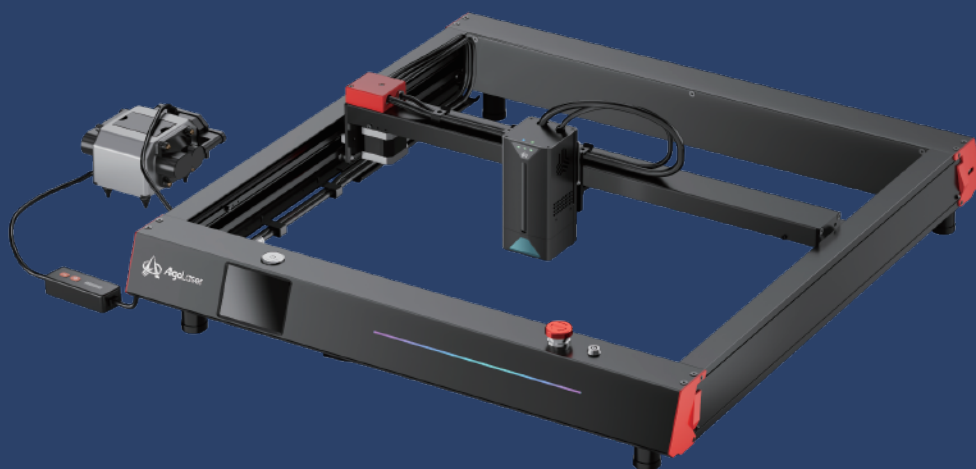

# 01

## Before You Start

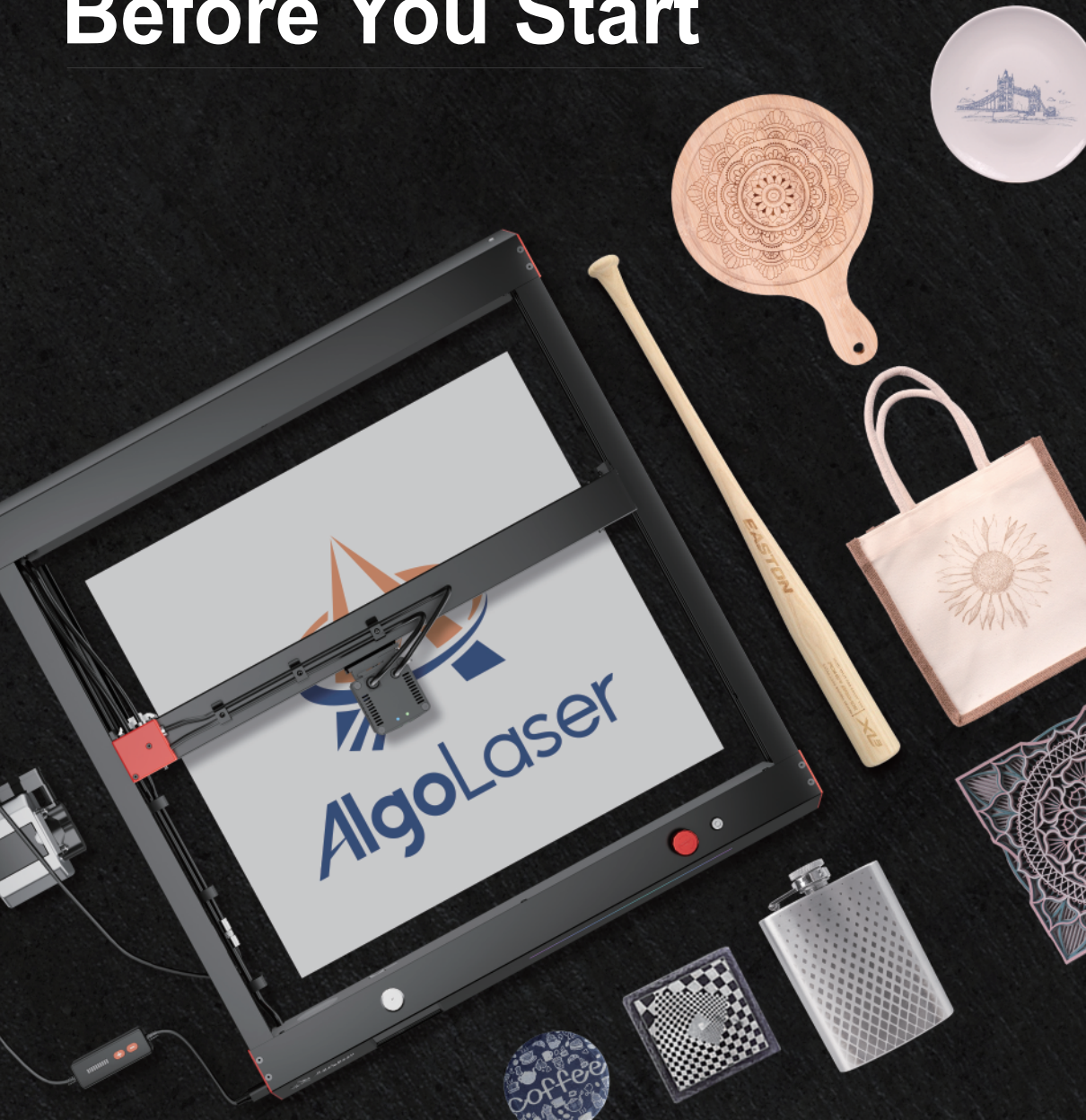



## 1.1 Disclaimer and safety Guidelines

- 1.The laser engraver emits laser light. Placing any living body under the laser emission port (marked with an orange warning sign) is strictly forbidden.
- 2.Patients with photosensitive epilepsy are prohibited from using or approaching the laser engraver.
- 3.When using the laser engraver, the operator and anyone near the machine must wear laser safety goggles. Operating the laser engraver without goggles' protection is not allowed. Our machine comes with a pair of safety goggles, but additional laser safety goggles need to be purchased separately. The goggles should offer wavelength protection of 400-445m ( $\pm 5$ m), an outer diameter of +5, and a minimum L-level L5.
- 4.Avoid placing flammable materials near the laser engraver. When the laser engraver is running, closely observe it and avoid leaving it unattended to prevent the engraved objects from catching fire. Set up the laser engraver in a fireproof area and ensure proper ventilation. If possible, we recommend purchasing a fire extinguisher and keeping it nearby the machine.
- 5.Ensure there is enough space when operating the laser engraver. Engraving certain materials may produce smoke, so it's important to use exhaust equipment to vent the smoke out.
- 6.When the machine is running, avoid letting your body or other objects touch the laser beam, as this may cause serious bodily injury or beam reflection. Do not touch the radiator, as it may still be hot even after the laser engraver has stopped working.
- 7.Do not allow children or teenagers to use the laser engraver alone, especially children under the age of 14. Adult supervision is required at all times.
- 8.The operating temperature range of the machine is  $-10^{\circ}\text{C}$  to  $40^{\circ}\text{C}$ .
- 9.The use of the laser engraver carries a significant risk of fire.  
When operating the machine, please ensure that someone is available to handle any potential fire emergencies at all times.



# 1.1 Haftungsausschluss und Sicherheitsvorschriften

1. Der Lasergravierer sendet Laserlicht aus. Das Platzieren lebender Körper unter der Laseraustrittsöffnung (gekennzeichnet mit einem orangefarbenen Warnschild) ist strengstens verboten.
2. Patienten mit lichtempfindlicher Epilepsie ist es untersagt, den Lasergravierer zu benutzen oder sich ihm zu nähern.
3. Bei der Verwendung des Lasergravierers müssen der Bediener und alle Personen in der Nähe der Maschine eine Laserschutzbrille tragen. Der Betrieb des Lasergravierers ohne Schutzbrille ist nicht gestattet. Im Lieferumfang unserer Maschine ist eine Schutzbrille enthalten, eine zusätzliche Laserschutzbrille muss jedoch separat erworben werden. Die Schutzbrille sollte einen Wellenlängenschutz von 400–445 nm ( $\pm 5$  nm), einen Außendurchmesser von  $\pm 5$  mm und einen L-Level von mindestens L5 bieten.
4. Platzieren Sie keine brennbaren Materialien in der Nähe des Lasergravierers. Wenn das Lasergraviergerät in Betrieb ist, beobachten Sie es genau und lassen Sie es nicht unbeaufsichtigt, um zu verhindern, dass die gravierten Objekte Feuer fangen. Stellen Sie den Lasergravierer an einem feuersicheren Ort auf und sorgen Sie für ausreichende Belüftung. Wenn möglich, empfehlen wir die Anschaffung eines Feuerlöschers und dessen Aufbewahrung in der Nähe der Maschine.
5. Stellen Sie sicher, dass beim Betrieb des Lasergravierers genügend Platz vorhanden ist. Beim Gravieren bestimmter Materialien kann Rauch entstehen. Daher ist es wichtig, eine Absauganlage zu verwenden, um den Rauch abzuleiten.
6. Vermeiden Sie bei laufender Maschine, dass Ihr Körper oder andere Gegenstände den Laserstrahl berühren, da dies zu schweren Verletzungen oder Strahlreflexionen führen kann. Berühren Sie nicht den Heizkörper, da dieser auch dann noch heiß sein kann, wenn der Lasergravierer nicht mehr funktioniert.
7. Erlauben Sie Kindern oder Jugendlichen nicht, den Lasergravierer alleine zu benutzen, insbesondere nicht Kindern unter 14 Jahren. Es ist jederzeit eine Aufsicht durch Erwachsene erforderlich.
8. Der Betriebstemperaturbereich der Maschine beträgt  $-10$  °C bis  $40$  °C.
9. Bei der Verwendung des Lasergravierers besteht erhebliche Brandgefahr. Bitte stellen Sie beim Betrieb der Maschine sicher, dass jederzeit jemand zur Verfügung steht, der für eventuelle Brandfälle zuständig ist.



## 1.1 Clause de non-responsabilité et consignes de sécurité

1. Le graveur laser émet une lumière laser. Il est strictement interdit de placer tout corps vivant sous le port d'émission laser (marqué d'un panneau d'avertissement orange).
2. Il est interdit aux patients souffrant d'épilepsie photosensible d'utiliser ou de s'approcher du graveur laser.
3. Lors de l'utilisation du graveur laser, l'opérateur et toute personne à proximité de la machine doivent porter des lunettes de sécurité laser. L'utilisation du graveur laser sans lunettes de protection n'est pas autorisée. Notre machine est livrée avec une paire de lunettes de sécurité, mais des lunettes de sécurité laser supplémentaires doivent être achetées séparément. Les lunettes doivent offrir une protection contre les longueurs d'onde de 400 à 445 m ( $\pm 5$  m), un diamètre extérieur de +5 et un niveau L minimum L5.
4. Évitez de placer des matériaux inflammables à proximité du graveur laser. Lorsque le graveur laser est en marche, observez-le attentivement et évitez de le laisser sans surveillance pour éviter que les objets gravés ne prennent feu. Installez le graveur laser dans une zone à l'épreuve du feu et assurez-vous d'une ventilation adéquate. Si possible, nous vous recommandons d'acheter un extincteur et de le garder à proximité de la machine.
5. Assurez-vous qu'il y a suffisamment d'espace lors de l'utilisation du graveur laser. La gravure de certains matériaux peut produire de la fumée, il est donc important d'utiliser un équipement d'évacuation pour évacuer la fumée.
6. Lorsque la machine est en marche, évitez de laisser votre corps ou d'autres objets toucher le faisceau laser, car cela pourrait entraîner des blessures corporelles graves ou une réflexion du faisceau. Ne touchez pas le radiateur, car il peut encore être chaud même après que le graveur laser a cessé de fonctionner.
7. Ne laissez pas les enfants ou les adolescents utiliser seuls le graveur laser, en particulier les enfants de moins de 14 ans. La surveillance d'un adulte est requise à tout moment.
8. La plage de température de fonctionnement de la machine est de  $-10^{\circ}\text{C}$  à  $40^{\circ}\text{C}$ .
9. L'utilisation du graveur laser comporte un risque d'incendie important. Lors de l'utilisation de la machine, veuillez vous assurer que quelqu'un est disponible à tout moment pour gérer toute urgence potentielle en cas d'incendie.



# 1.2 Parts List

## 1.2.1 Machine

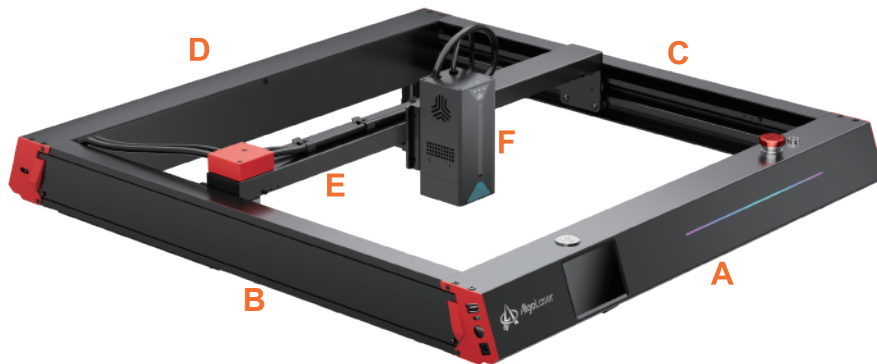

**A** Front Assembly \* 1

**B** Left Y-Axis Assembly \* 1

**C** Right Y-Axis Assembly \* 1

**D** Rear Panel Assembly \* 1

**E** X-Axis Assembly \* 1

**F** LB-20A Laser Module \*1

**G**  Support Foot \* 4

**H**  Wifi Aerial \* 1

**I**  M4X10 Screw \* 4  
M4X22 Screw \* 1

**J**  Pipe \* 1

**K**  AlgoLaser Air pump(AAP 1.0)

**L**  Power Adapter \* 1

**M**  Power Cable \* 1

**N**  USB Cable \* 1

**O**  M2.5 Allen Key \* 1

**P**  Machine Key Set \* 1

**Q**  Laser Goggle \* 1

**R**  Brush \* 1

## 1.2.2 Laser module

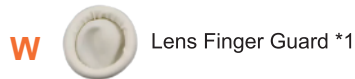
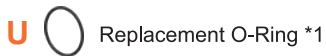

## 1.2.3 Consumable

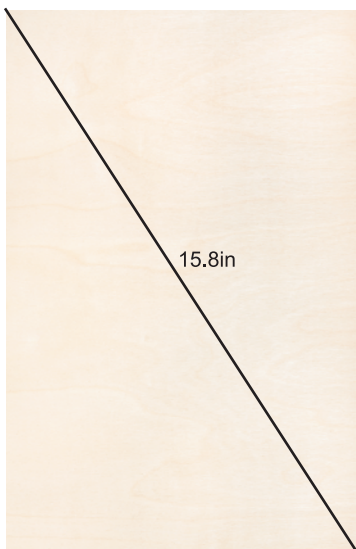

Plywood \*1  
(340mm\*220mm\*3mm)

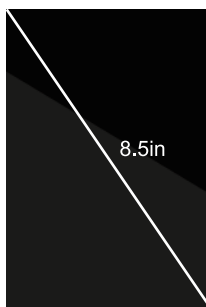

Acrylic \*1  
(175mm\*122.5mm\*3mm)



Metal Card \*3  
(86mm\*54mm\*0.2mm)



# 02

## Machine Assembly







**01** /16

## Remove the Packaging



Step 1: Hold the handle and remove the foam from the packaging box.

Please note that the machine and foam should be **taken out together and must not be separated.**

## Assemble the X-Axis Assembly

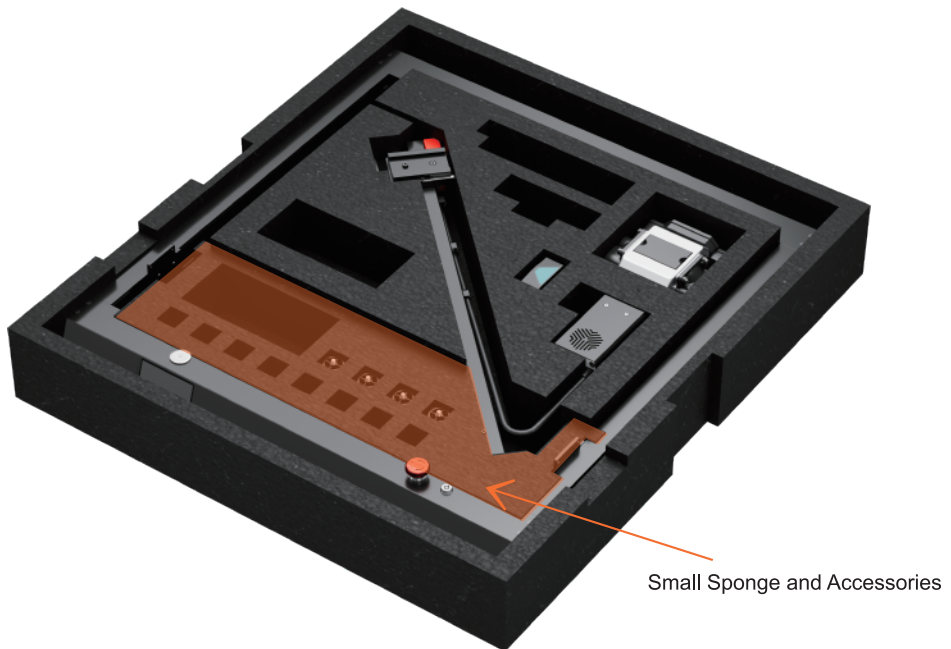
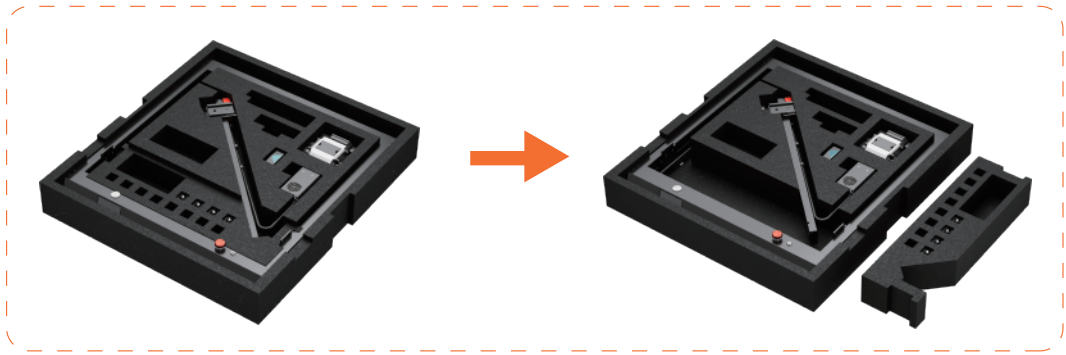

Step 2: Take out the small sponge and its accessories from the foam.

 **03** /16

Take out the Laser Module



 **04** /16

## Mount the Air Assist

- ▶ **Attention:** The module should operate with an working air pump. Make sure the air pump is running while the module is working.
- ▶ please clean the lens after every 30 hours of use of the machine or after a long period of inactivity to prevent the laser from being intercepted by the dust attached to the lens.
- ▶ Remove the Lens from the Air Assist.
- ▶ Use a medical swab and alcohol to wipe the lens.





## Mount the Laser Module

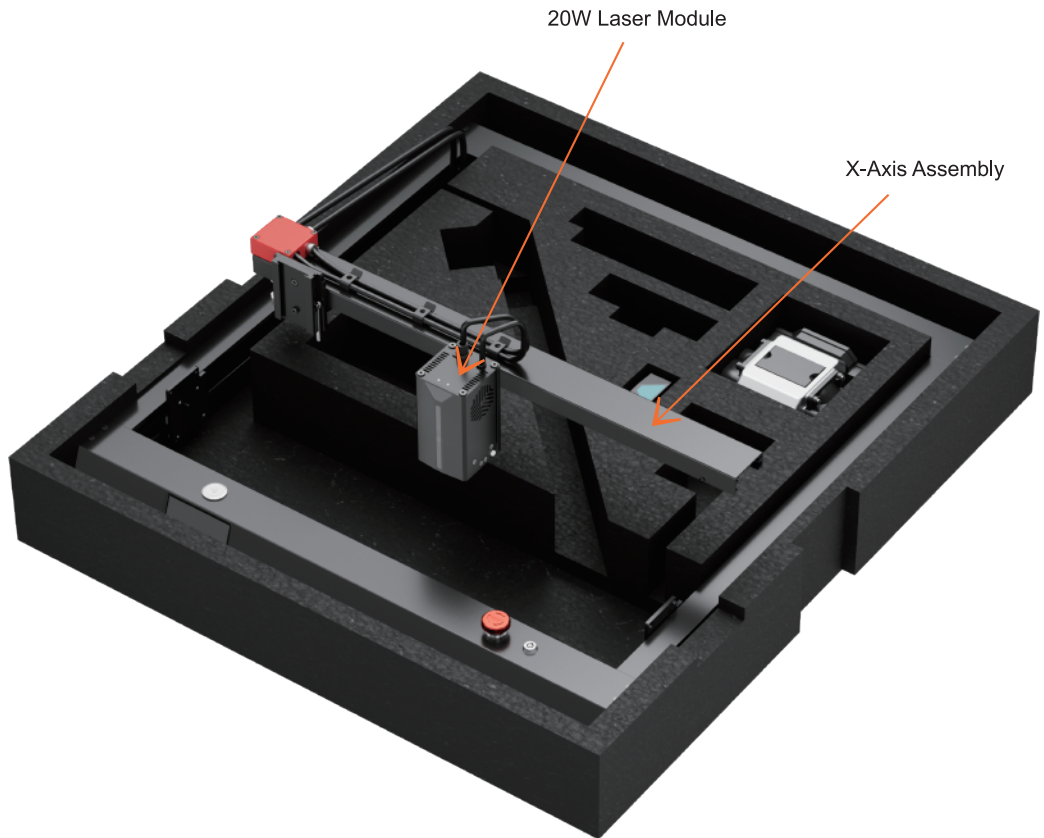

20W Laser Module

X-Axis Assembly

Step 5: Take out X-Axis Assembly, and mount the Laser Module on it.

## Mount the Laser Module

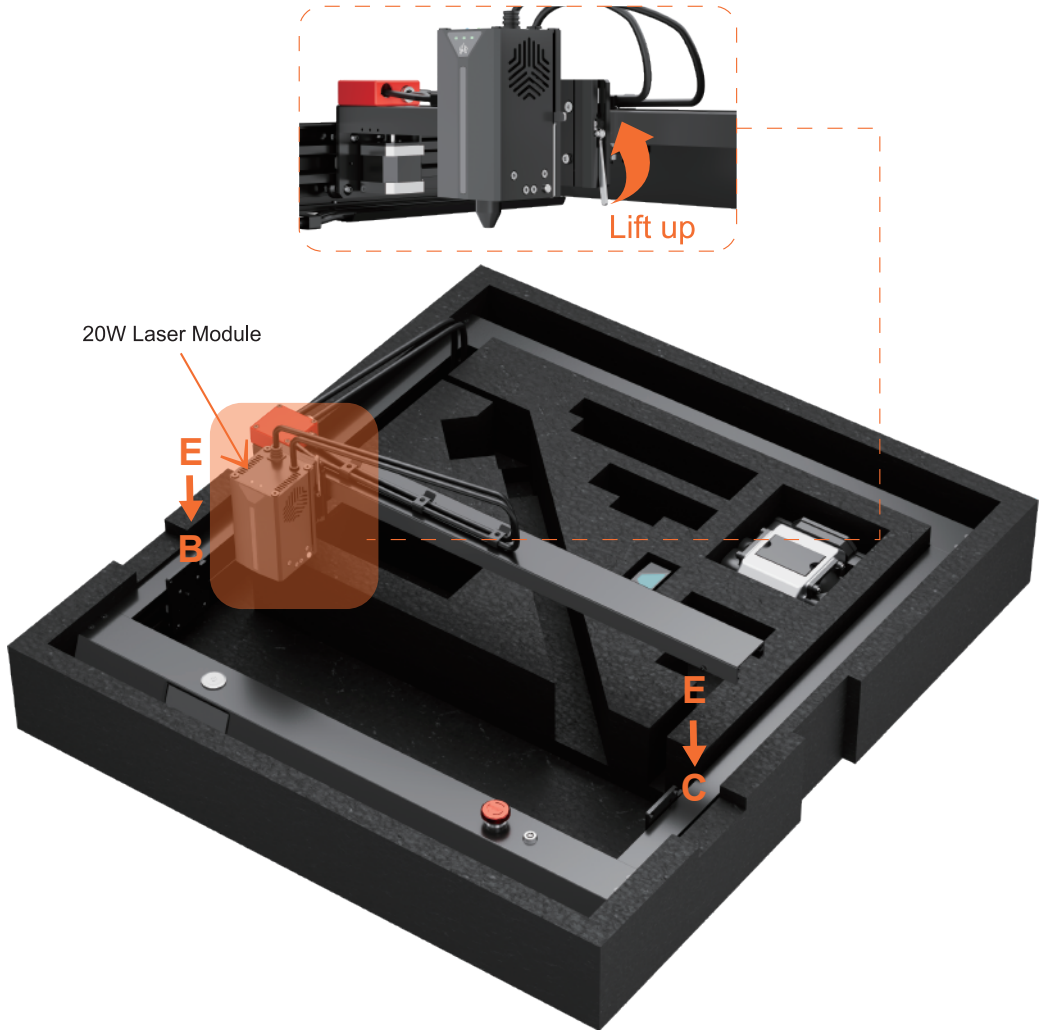

Step 6: Insert the laser module into the fixture from the top and raise the lever, ensuring it makes contact with the magnet for a secure fit.





## Assemble the X-Axis Assembly



Step 7: Place X-Axis Assembly on the top of the machine. NOTE: X-Axis Assembly with the end of the Cable Box should face Left Y-Axis Assembly.

Then install the end with Cable Box of X-Axis Assembly on the Block of Left Y-Axis Assembly with 2 screws.

Install the other end of the X-Axis Assembly on the Block of Right Y-Axis Assembly with 2 screws.

Screw type: M4X10 Screw

## Take Out the Machine

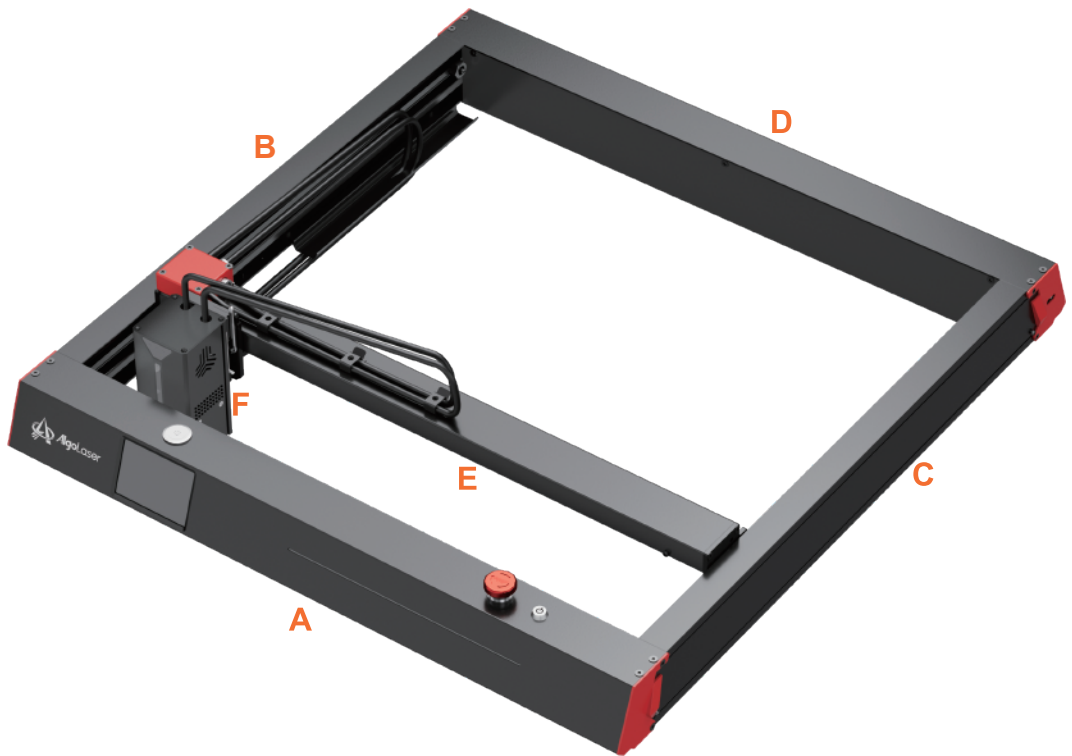

## Tighten the Belt

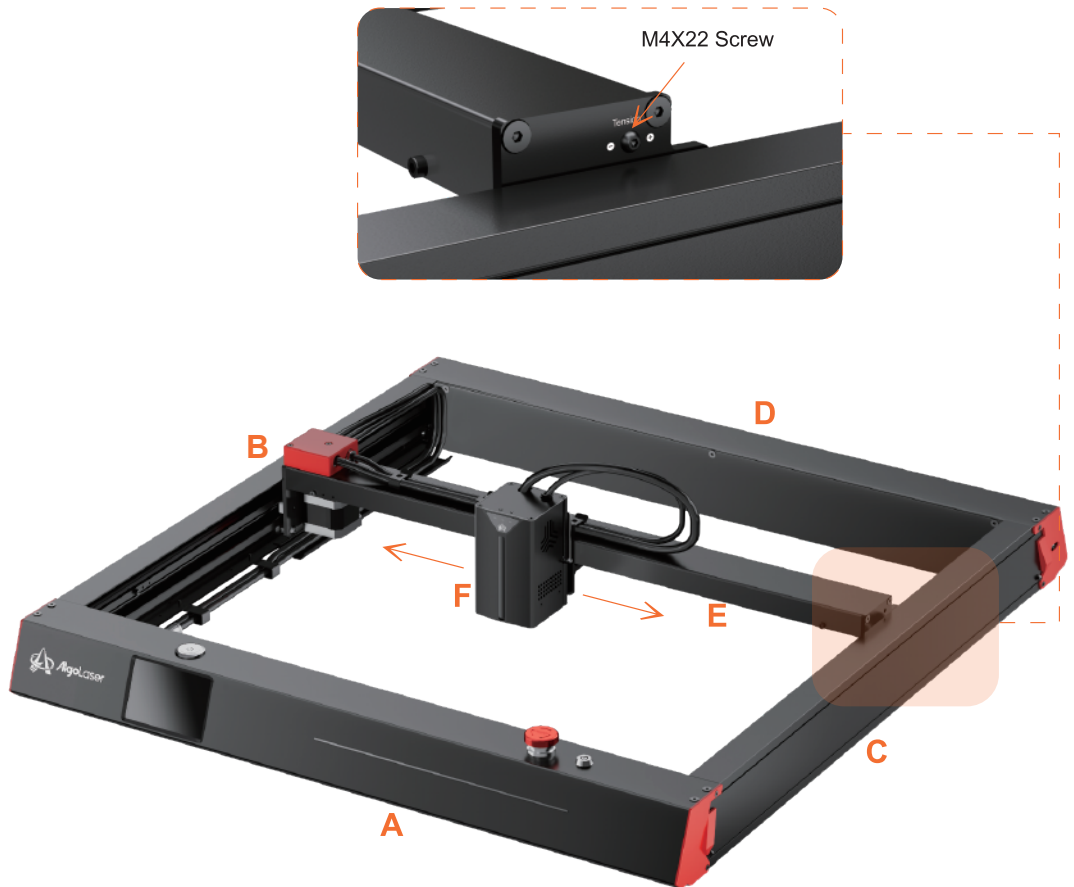

Step 9: Install a screw on E (X-Axis Assembly), and tighten the screw until the belt is properly tightened (this means the laser module can move smoothly).

Screw type: M4X22 Screw



10 / 16

## Adjust the Belt

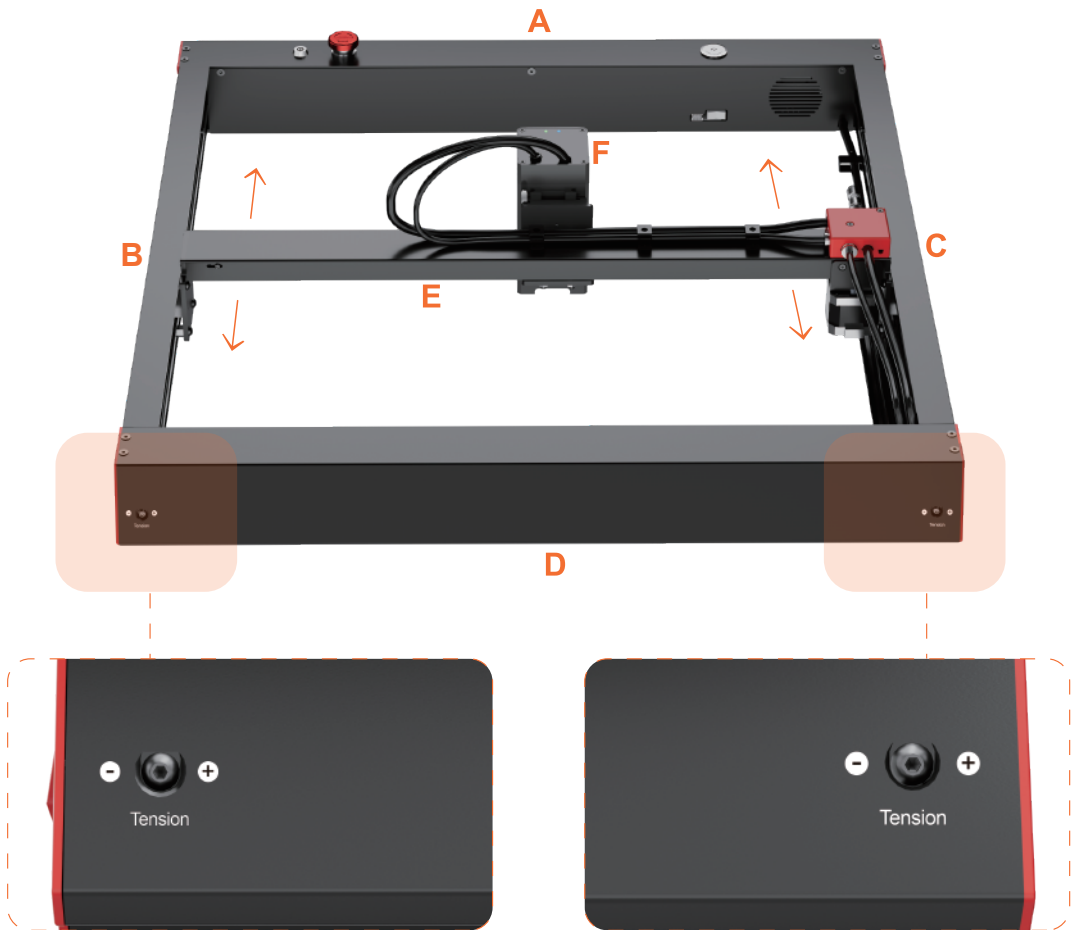

Step 10: Slide the X-Axis Assembly and ensure smooth movement. If it doesn't slide smoothly, please adjust the screw. Turning the screw in the "+" direction tightens the belt, while turning it in the "-" direction loosens the belt.



11 /16

## Flip the Machine

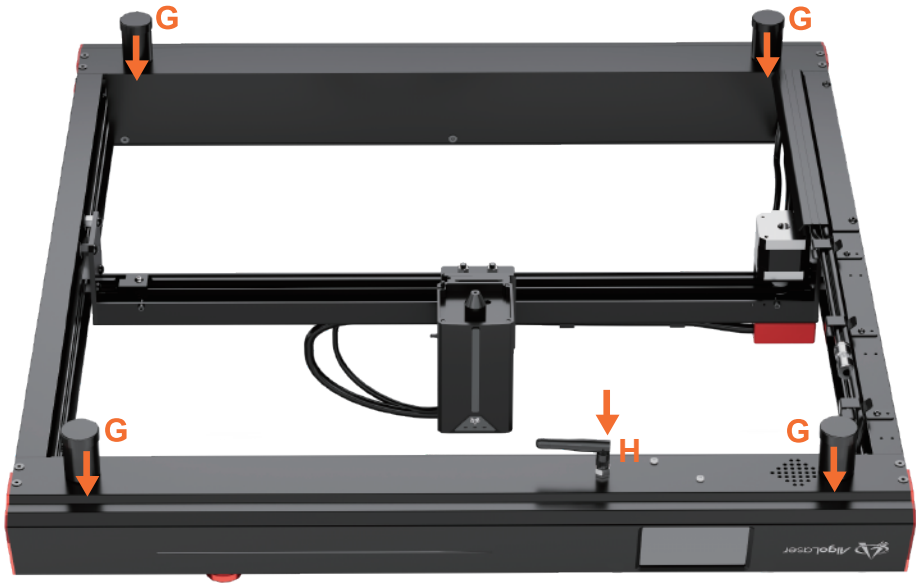
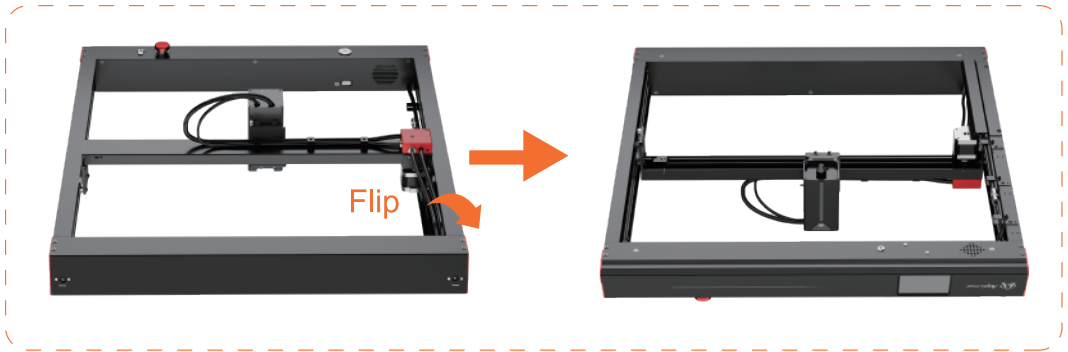

Step 11: Turn the machine upside down and attach the Feet and Antennae to the bottom. Then flip the machine back over, placing it face-up.



**12** / 16

## Install the Laser Shield

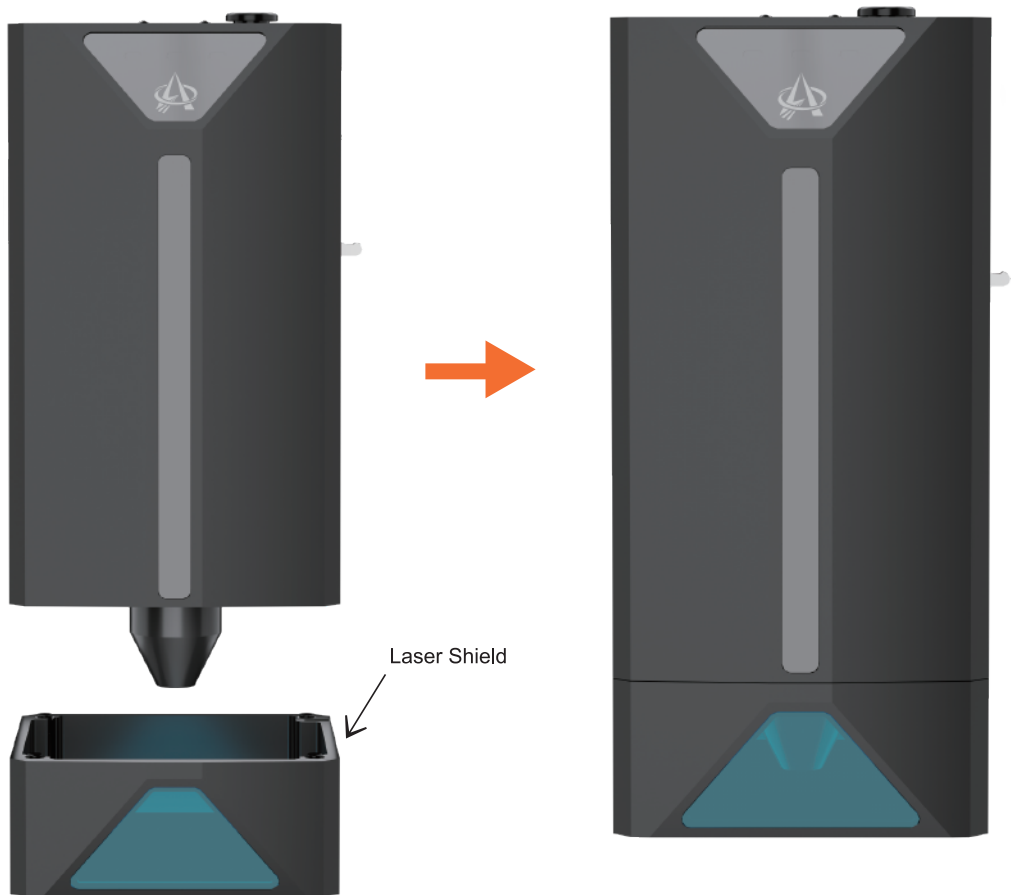

Step 12: Attach the magnetic side of the Laser Shield to the laser module.





## How to Focus

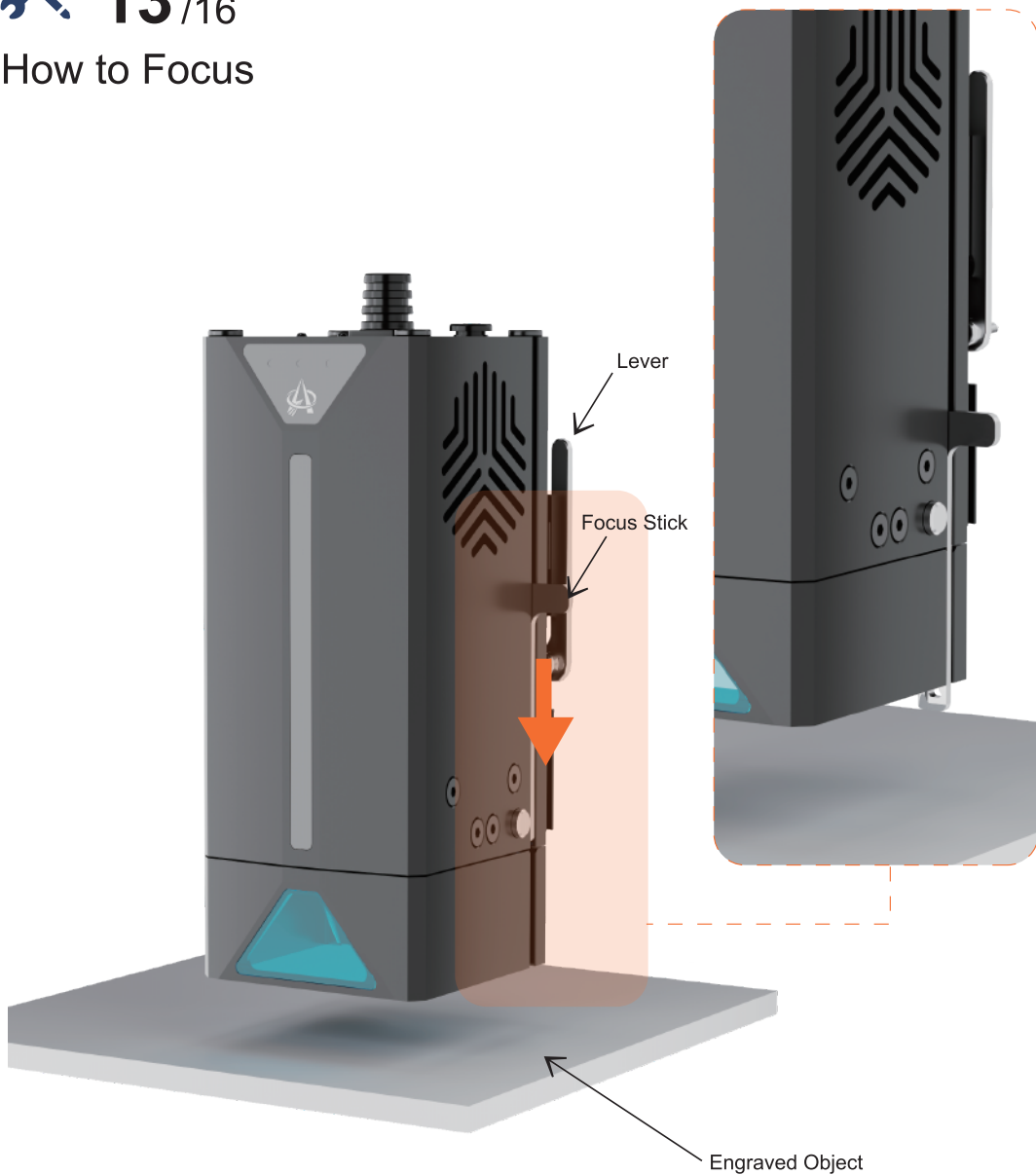

Step 13: Place the engraving object and push the Focus Stick down to fix.



## How to Focus



Step 14: Pull down the lever, let the laser module move down until the Focus Stick is against the engraved object, and then lift up the lever to fix the laser module.



**15** /16

## How to Focus



Step 15: After focusing, please press the small button to reset the Focus Stick to prevent it from being damaged.

 **16** /16

Complete



Step 16: The type-C to USB cable is used to connect the computer and machine. Ensure that the type-C end is plugged into the laser machine, while the USB end is plugged into the computer.

# 03

## How to Use

---

photosensitive epilepsy.  
essentially trigger seizures or  
with care professional if you  
ved by adjustment errors.

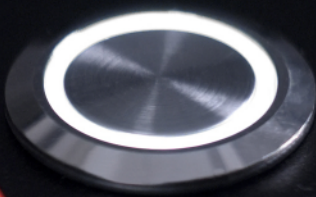

Power



engrave

Setting

## 3.1 Machine status description

State	Operate	Phenomenon	Result
Power On	Press and hold the power button for more than 500ms.	The white LED will transition from dim to bright, and the light strips will gradually illuminate from the center towards both sides.	The machine is now powered on and quickly seeking its zero point.
Power Off	Method 1: Press and hold the power button for more than 3000ms (3 seconds). Method 2: On the home screen, select "Shutdown" from the bottom left corner.	The white LED will transition from bright to dim, and the light strips will gradually dim from both sides towards the center.	The machine will power off and all operations will stop.
Standby	The machine is powered on and in an idle state.	The white LED is constantly on, and the light strips are displaying a colorful and breathing pattern.	The machine is in a standby mode, ready for operation.
In Operation	The machine is powered on and in a working state.	The cyan-blue LED is constantly on, and the light strips have a light blue background with a green progress bar indicating the engraving progress.	The machine is in a processing state, actively working on engraving tasks.
Fault Indicator	The machine has encountered a malfunction and cannot perform engraving motion.	The LED shows no change, and the light strips slowly flash in yellow, accompanied by a <di> sound.	The machine is unable to proceed with engraving, indicating a malfunction.
Screen Feedback	Using the screen.	Upon tapping the screen, it emits a <di> sound.	The screen provides feedback and navigates to the corresponding information.

## 3.2 How to connect the machine to a computer

- Install the driver: Before installing the computer driver, please power on the machine and connect it to the PC using a USB cable. Then, choose the appropriate driver file based on your computer system and proceed with the installation.



Computer System	Driver File	Remarks
WIN 7 / WIN 8	 zadig-2.5.exe	To install this driver, the machine needs to be in the powered-on state and connected to the computer via USB for the installation to proceed.
WIN 10 / WIN 11	No installation required	
Mac	No installation required	

- To check the driver installation, follow these steps:
  - ① Find the Device Manager on your computer.
  - ② Navigate to the Ports section.
  - ③ Disconnect the USB cable from the computer.
  - ④ Observe that the new serial port disappears from the Ports section.
  - ⑤ Reconnect the USB cable.
  - ⑥ Verify that a new serial port appears, indicating successful driver installation.

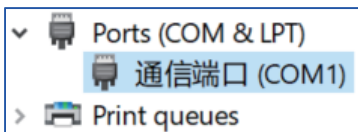

- Connecting the machine:
  - ① Launch the LaserGRBL/LightBurn software.
  - ② Select the COM port that corresponds to the one identified in step two of the installation process.
  - ③ Click on the "Connect" button.
  - ④ If a welcome message appears in the command box, it indicates a successful connection.

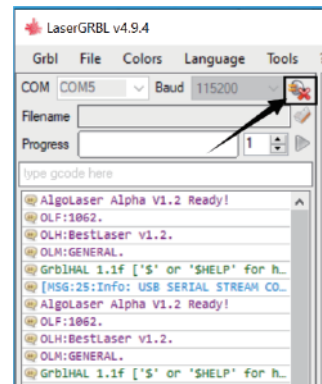
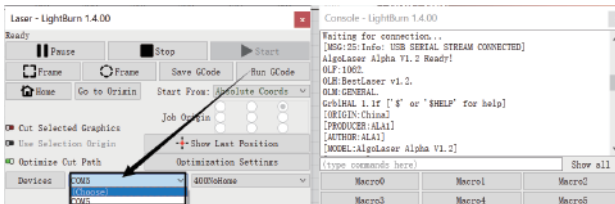

# For resolving driver issues on Windows 7/8, you can follow these steps

Resolution for Driver issues on ESP MCU Espressif CDC Device Error

(Applicable to WINDOWS 7/8 )

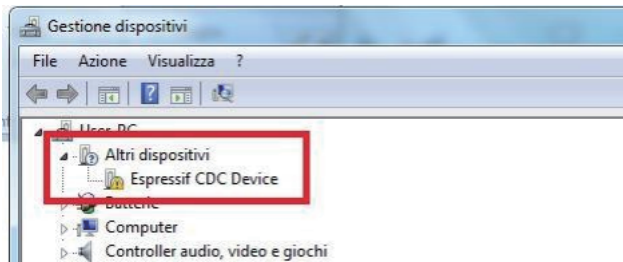

- Click the download link to download the file: [Zadig-2.5.exe](https://zadig.akeo.ie)



Zadig-2.5.exe

**Download:**[https://zadig.akeo.ie/](https://zadig.akeo.ie)

- Once download is complete, please run the application with Administrator Rights.
- Once opened, select List All Devices in Options from the menu.

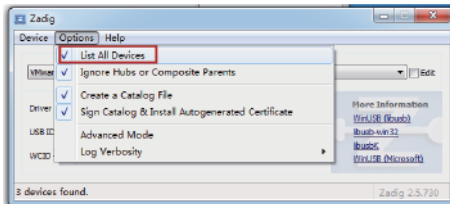

**Wait for the refresh**

- Select Espressif CDC Device (Interface 0) from the drop-down list.

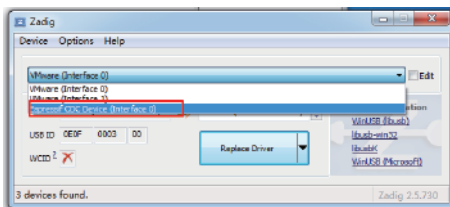

- Select USB Serial (CDC) from the list of drivers available. Click the Install Driver button, and wait for the installation to complete.

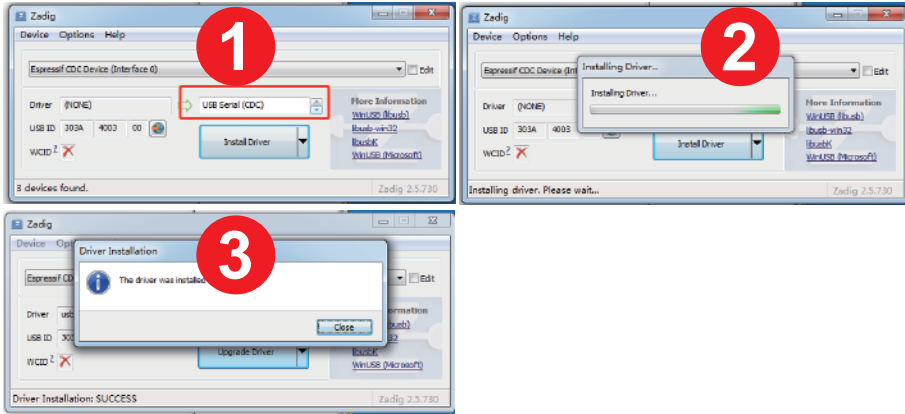

- When you are done, you can close the Zadig software.
- The New Expressif CDC Device (Interface 0) (COM X) port in Device Manager. Note: The COM number might be different in your machine.

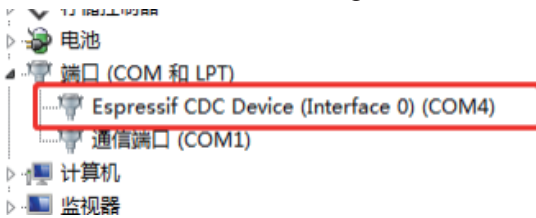

### 3.3 YRR/YRC connection -- Operation description

- Connection: Unplug the Y-Axis motor wire from the Y-Axis motor and connect it to the corresponding motor jack of YRR/YRC.
- Connect the control terminal: Use USB or other methods to connect the computer.
- LaserGRBL: Send "\$22=0" in the "Type gcode here" field.

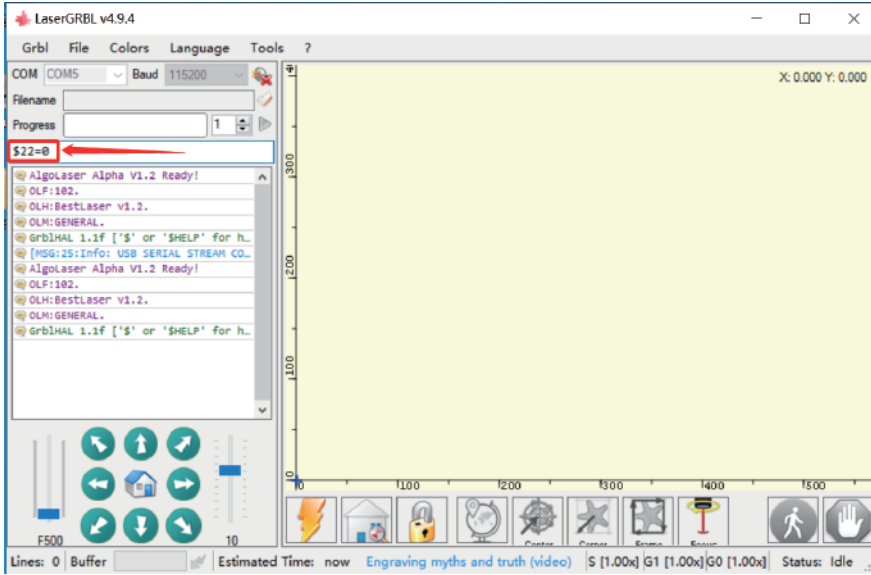

- LightBurn: Send the command "\$22=0" in the "(Type Commands here)" field.

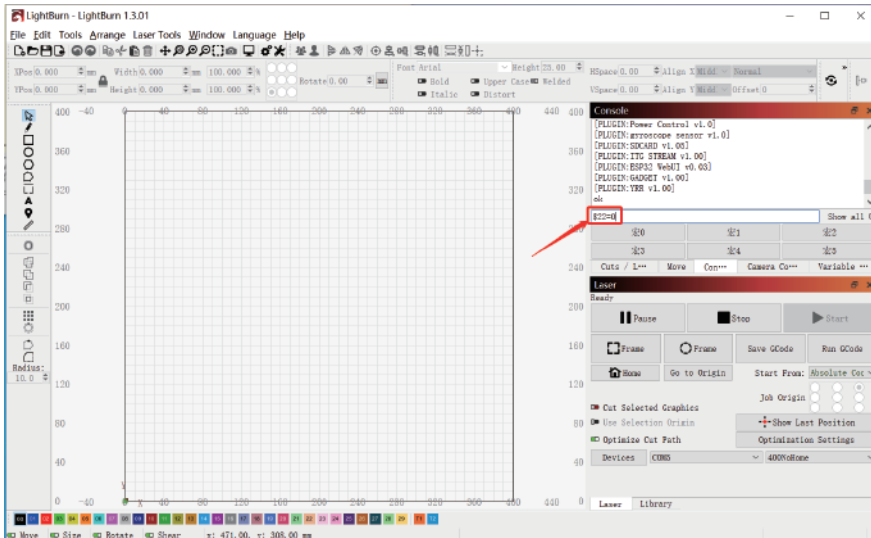

## 3.4 YRR/YRC Connection -- Operation description

- Connection: Unplug the Y-Axis motor wire from the Y-Axis motor and connect it to the corresponding motor jack of YRR/YRC.
- Connect the control terminal: Use USB or other methods to connect the computer.
- LaserGRBL: Send "\$22=0" in the "Type gcode here" field.

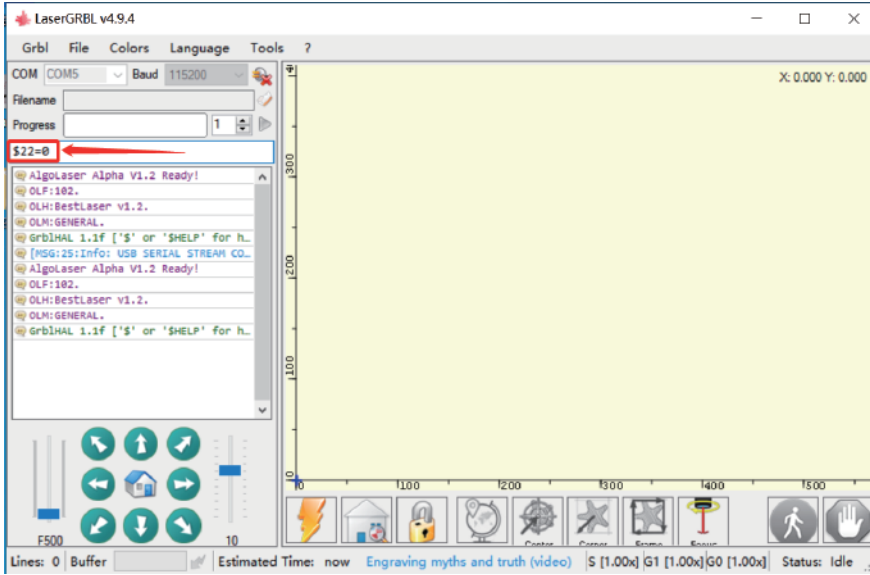

- LightBurn: Send the command "\$22=0" in the "(Type Commands here)" field.

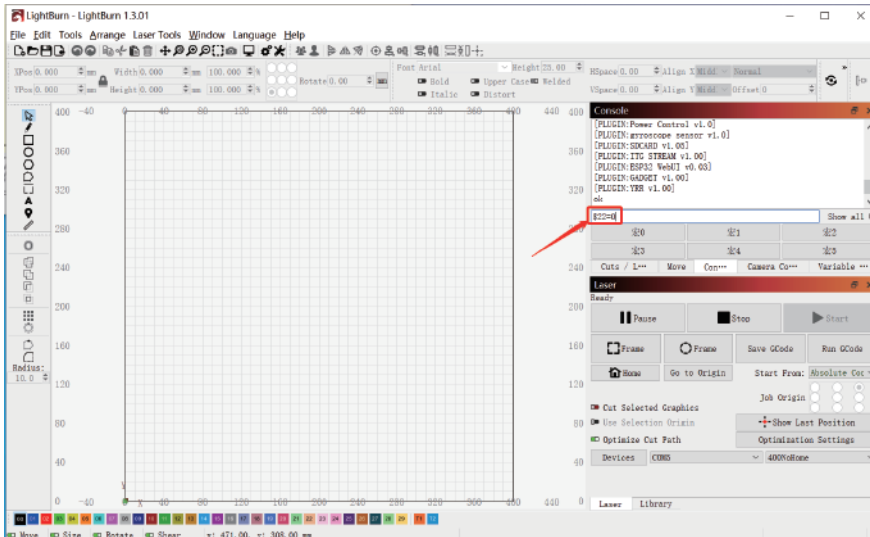

### 3.5 First-time screen usage instructions:

- Screen Switch: The screen will automatically power on and off with the machine.

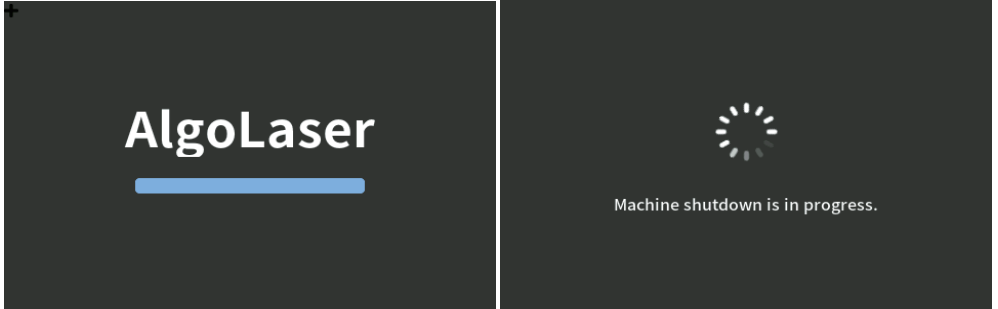

- First-time Use Guide: A. Language Selection: Choose your preferred language to proceed. If you skip this step, you can refer to the user manual to set a new language.



B. Device Naming: Give a unique name to your device. If you have multiple devices, make sure not to use the same name for any of them.

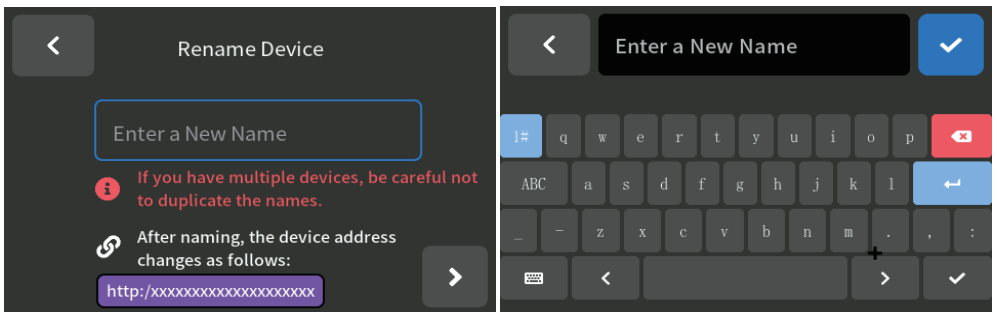



C. Network Connection: Choose the detected WiFi network and connect. If you need to add a WiFi network manually, click on the "+" icon on the left to manually add the WiFi network. Alternatively, you can click "Skip" to bypass the connection setup and proceed to use the device.

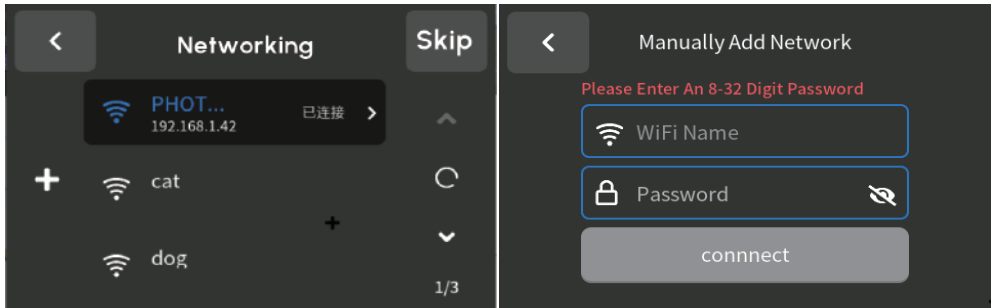

- Engraving via Screen: A. After powering on the machine, click on "Engrave" on the home page to enter the "Engraving Source" page. Select the desired engraving file source, which can be either from the SD card or USB. If using USB, make sure to insert the USB drive to access the data.

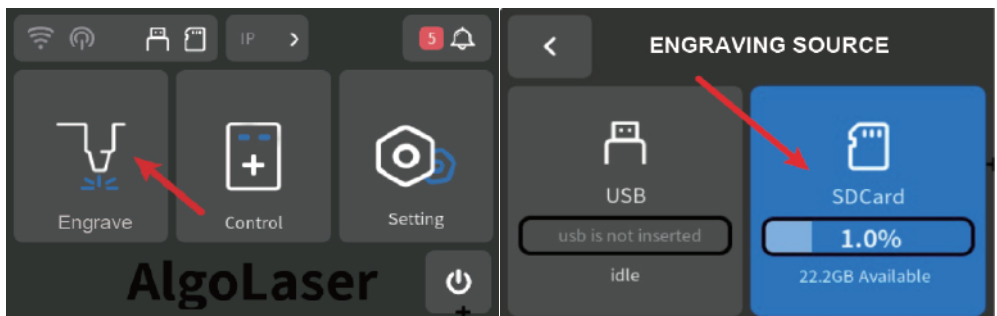

B. Select the file from the USB or SD card (jpg, png, bmp, or Gcode format), preview it, and click "Engrave" to start engraving.

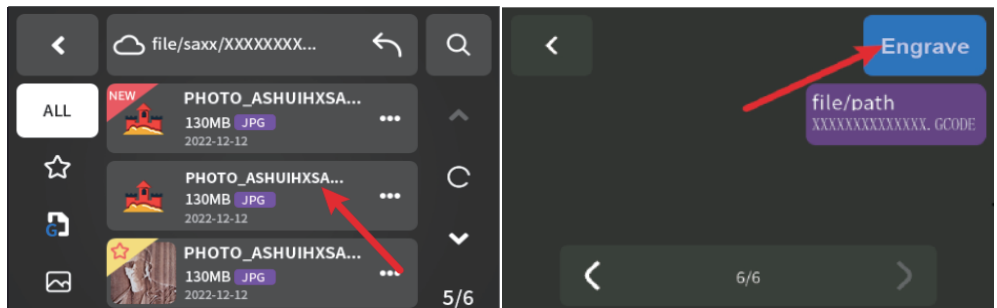

C. On the parameter page, select the engraving quality, power, mode, speed, and number of passes. Once the parameters are confirmed (detailed data available in the published cutting data), click "Start Processing" to enter the engraving preview page. Select "Engrave" to prepare for engraving, and use the right button for image preview.

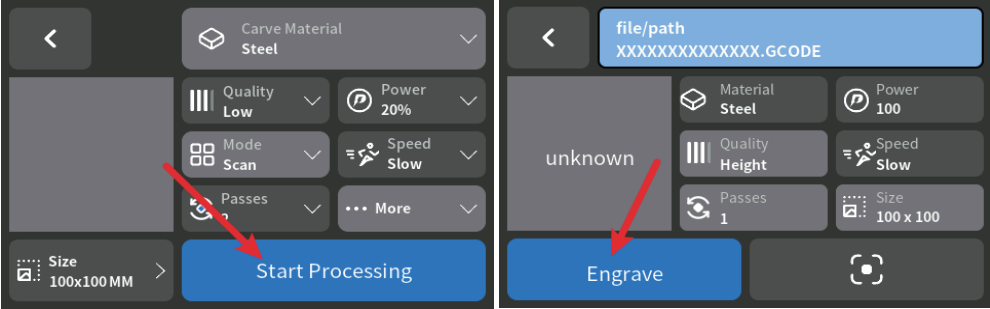

D. Focus verification is essential to ensure the correct focal length. Click "Next Step" once the focus is confirmed. For multiple engravings, adjust the number of passes using the "+" and "-" buttons. Once the desired number of passes is set, click "Next Step."

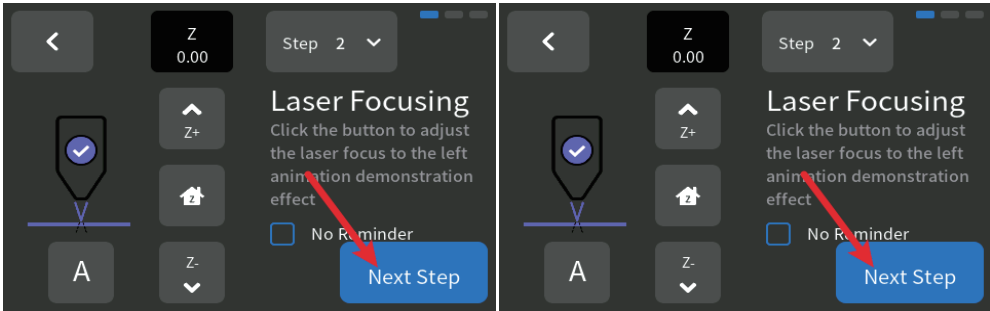

E. Preview the engraving area and set the origin point to ensure the laser module is positioned correctly. Once everything is verified, click "Engrave," and the laser engraving machine will start the process. Wait for the progress to reach 100% to complete the engraving.

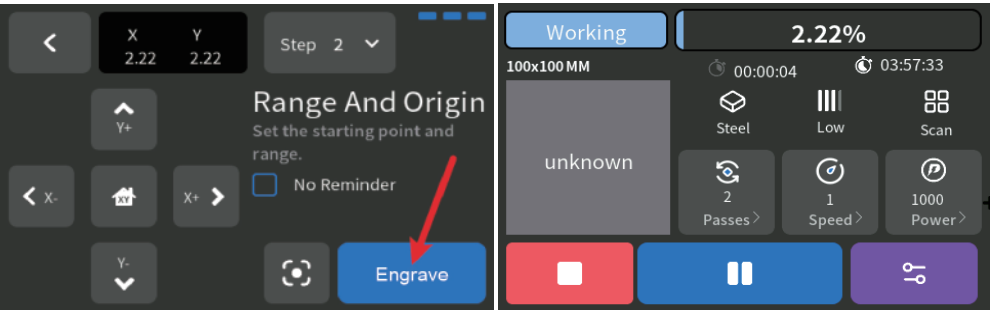

## 3.4 FAQ

### **No response from the machine when being powered on.**

- No power supply: Please check the socket and switch as well as the machine power socket to ensure that they have been correctly plugged with normal power supply.

### **It cannot be connected to computer .**

- USB cable not connected: Please check the USB data cable interface on the machine and computer to ensure it's correctly plugged. The USB interface on the front panel of some desktop computers is invalid, it's better to connect to the interface on the back.
- Driver not properly installed: Install the driver according to the instructions. After the installation is done, the computer will recognize the device as a serial port, which means the hardware connection is OK.
- Other special problems: Pull out the USB data cable and power cable, keep the machine power off for 5 seconds and then try the connection once again.

### **No response from the phone APP when being connected to the machine.**

- Incompatibility: In the case of abnormal connection due to incompatibility of newly-released phone or upgraded system, please contact our customer service with the screenshot of phone configuration so as to get technical support as soon as possible.

### **Shallow engraving effect or no traces.**

- Inaccurate focus: Refer to the "Focus Adjustment" in the User Manual to make the correct focus.
- Engraving speed: Too fast speed is due to short burning time. Please read the "Engraving Parameters" in the Manual to readjust the parameters.
- Photo color is too light: The photo added should be clear. If the line is too thin or the color is too light, the engraving effect will be directly influenced.
- Position of object to be engraved: If the object is placed obliquely, the object should be placed horizontally in parallel to the machine; otherwise, the inaccurate focal length will result in bad engraving effect.

### **Offline engraving unexpectedly stops .**

- The photo is not completely downloaded when being connected to computer, please download the photo once again.

## FCC Compliance Statements

This device complies with Part 15 of the FCC Rules. Operation is subject to the following two conditions: (1) this device may not cause harmful interference, and (2) this device must accept any interference received, including interference that may cause undesired operation.

Caution: Changes or modifications not expressly approved by the party responsible for compliance could void the user's authority to operate the equipment.

Note: This equipment has been tested and found to comply with the limits for a Class B digital device, pursuant to Part 15 of the FCC Rules. These limits are designed to provide reasonable protection against harmful interference in a residential installation. This equipment generates, uses and can radiate radio frequency energy and, if not installed and used in accordance with the instructions, may cause harmful interference to radio communications. However, there is no guarantee that interference will not occur in a particular installation.

If this equipment does cause harmful interference to radio or television reception, which can be determined by turning the equipment off and on, the user is encouraged to try to correct the interference by one or more of the following measures:

- Reorient or relocate the receiving antenna.
- Increase the separation between the equipment and receiver.
- Connect the equipment into an outlet on a circuit different from that to which the receiver is connected.
- Consult the dealer or an experienced radio/TV technician for help.

## ISED Compliance Statements

This device contains licence-exempt transmitter(s)/receiver(s) that comply with Innovation, Science and Economic Development Canada's licence-exempt RSS(s). Operation is subject to the following two conditions:

- (1) This device may not cause interference.
- (2) This device must accept any interference, including interference that may cause undesired operation of the device.

This equipment complies with IC RSS-102 radiation exposure limits set forth for an uncontrolled environment.

L'émetteur/récepteur exempt de licence contenu dans le présent appareil est conforme aux CNR d'Innovation, Sciences et Développement économique Canada applicables aux appareils radio exempts de licence. L'exploitation est autorisée aux deux conditions suivantes :

- (1) L'appareil ne doit pas produire de brouillage;
- (2) L'appareil doit accepter tout brouillage radioélectrique subi, même si le brouillage est susceptible d'en compromettre le fonctionnement.

Cet équipement est conforme aux limites d'exposition aux radiations IC CNR-102 établies pour un environnement non contrôlé.

## RF Exposure Compliance

This equipment complies with FCC/IC RSS-102 radiation exposure limits set forth for an uncontrolled environment. This equipment should be installed and operated with minimum distance 20cm between the radiator and your body. This transmitter must not be co-located or operating in conjunction with any other antenna or transmitter.

Cet équipement est conforme aux limites d'exposition aux radiations IC CNR-102 établies pour un environnement non contrôlé. Cet équipement doit être installé et utilisé avec une distance minimale de 20cm entre le radiateur et votre corps. Cet émetteur ne doit pas être colocalisé ou fonctionner en conjonction avec une autre antenne ou un autre émetteur.





**MADE IN CHINA**

<https://algolaser.com/support/>