

shower *buddy*®



OWNERS MANUAL
SB6c & SB6w

INTENDED USAGE:

The Showerbuddy shower/commode chair is a medical device indicated for use by persons with limited mobility who are unable to stand, walk and/or seat independently. The device is specifically designed for individuals who require additional support and stability during washing, toileting and other hygienic activities. It is a class 1 medical device, which is intended to be used only as a seating option for toilet issues, showering and bathing. Its purpose is to help physically handicapped people during their hygienic activities. Any other use is prohibited.

INDICATIONS:

The device is specifically indicated for individuals who (because of the wide variety of possible health problems) are unable to stand and /or walk and so they need an assistance device to maintain some or all daily hygienic tasks.

CONTRADICTIONS:

This type of device must not be used by a disabled person alone. The user should always be accompanied by a caregiver or assistance person. The device is not recommended for persons with flaccid paralysis or other diseases that cause serious body control problems. Such persons require special wheelchairs designed for extra stability and support of the user's body. The need for this type of specialty wheelchair should be always estimated and indicated by a physician or a physical therapist.

WARNING – Included in this packaging and fitted to the Showerbuddy chair are small parts, plastic wrap and polystyrene packing that could be dangerous to children under 5.

Keep children away from this device and do not let them play with any parts.



Be careful! Fingers or other body parts of a user and/or assistant can be trapped between the device's parts during folding, unfolding or adjusting of the device. Be extremely careful when adjusting the device. Observe the dimensions of gaps between the device's parts to avoid trapping your fingers or other body parts.



Exploded Parts	4
Parts List	5
Assembly & Use	6
Cleaning	11
Safety Instructions	12
Warranty	15

SB6c

Exploded Parts

Arm Design varies - Check Your Model

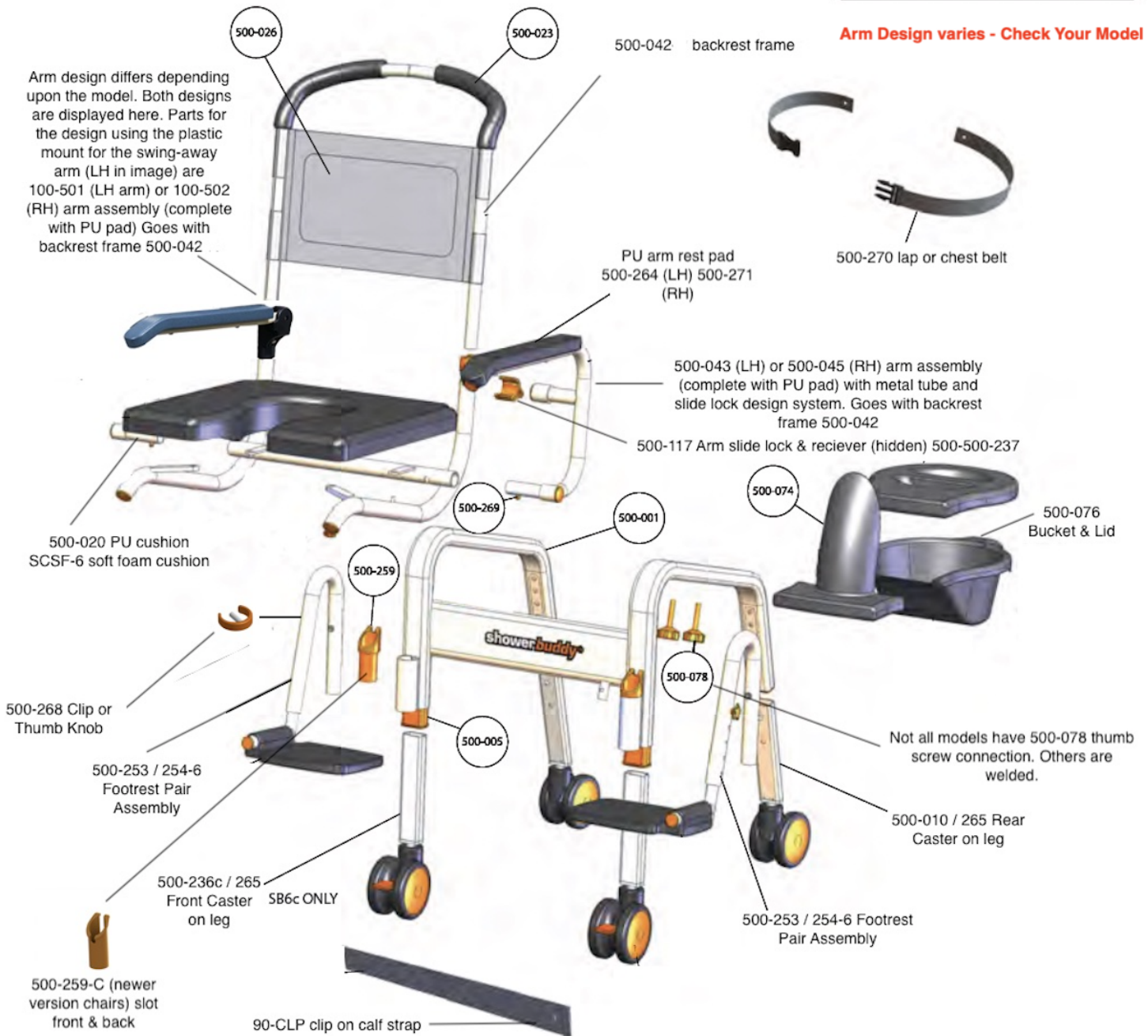

Parts List

SB6w only

500-001 Main Frame, Top & Bottom

500-042 Back Rest Frame

500-052 Wheelchair Axle

500-043 LH Arm Assembly - Metal Tube type

500-045 RH Arm Assembly Metal Tube Type

500-049 Wheelchair Main Bracket

500-270 Safety Harness

500-117 Arm Lock

500-059 Wheelchair Brake Assembly

500-073 Commode Lid

500-237 Arm Lock Clip

500-035 Anti Tip Leg

500-074 Commode Deflector

500-005 Caster Leg Sleeve

500-036 Anti Tip Foot

100-501 LH Arm Assembly - Plastic Mount

100-502 RH Arm Assembly - Plastic Mount

500-275 24" Wheel

500-072 Commode Bucket

500-010 / 265 Caster on Rear Leg

500-236-C / 265 Caster on Front Leg = SB6c ONLY

500-253 / 254-6 Footrest Assembly - PAIR

500-079 Seat Fixing Knob



Body text

500-078 Frame Fixing Knobs

500-255 Deflector Clip

500-268 Footrest Adjustment Clip or Knob

500-259-C Plastic Sleeve

500-269 Push Pin

SCSF-6 Seat Cushion Soft Foam

500-020 Seat Cushion in PU Foam

500-265 4" Caster Wheel

500-023 Foam Hand Grip

90-CLP Clip on Calf Strap

500-026 Sling Seat Back

500-271 RH Arm Pad

500-264 LH Arm Pad

500-236-W / 265
Caster on Front Leg
= SB6w ONLY

This Universal Parts List for SB6c and SB6w includes original and updated design components. Check the exploded parts diagram to obtain the correct part for your chair. if unsure contact your supplier.

ASSEMBLY

STEP 1

The seat cushion is factory fitted.



Unpack all components from the box.

Fit the 4 caster wheels into the leg openings in the main frame. The caster wheels have been factory-fitted to the legs.

Ensure you fit the front casters in the front legs and rear casters in the rear legs. They are not interchangeable and if fitted incorrectly the chair will not roll or rotate as intended.

Unpack all components from the box.

Fit the 4 caster wheels into the leg openings in the main frame. The caster wheels have been factory-fitted to the legs.

Ensure you fit the front casters in the front legs and rear casters in the rear legs. They are not interchangeable and if fitted incorrectly the chair will not roll or rotate as intended.

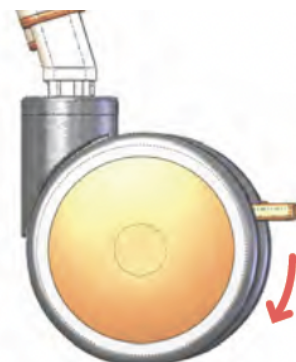

WARNING Always lock the caster wheels before you transfer a user to the chair. **6**

STEP 2

The backrest is supplied with factory fitted arms, fabric backrest and chest safety belt. Note that the chest belt can be relocated to a lap belt using the pre-drilled holes at the rear of the cushion.

To fit the backrest complete with arms, slide the black plastic arm mounts onto and over the tube uprights on the rear of the main frame at the back of the chair.

Push the backrest down over the upright tubes until the pins “pop” out and lock the backrest into position.

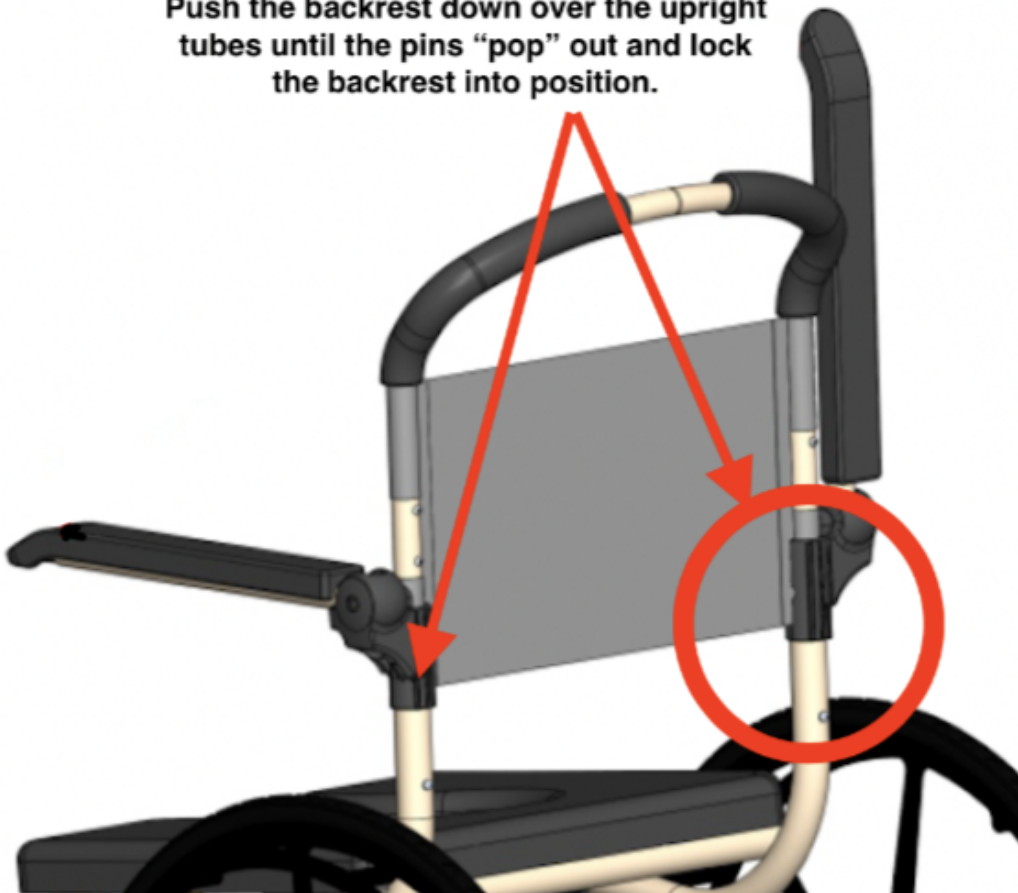

STEP 3

The footrests drop into the holder on each front leg of the chair.

When pushed all the way down the stainless steel pin drops into a slot to lock the footrests into position.



To swing the footrests away just lift them and swing to the side, or to remove - lift completely out of the holder.

STEP 4

The Commode Pail is fitted from the back of the chair by sliding it in into the rails sitting under the seat cushion.



The Pee Guard or Deflector is fitted from the front by sliding it in into the holders sitting under the seat cushion, each side of the opening.

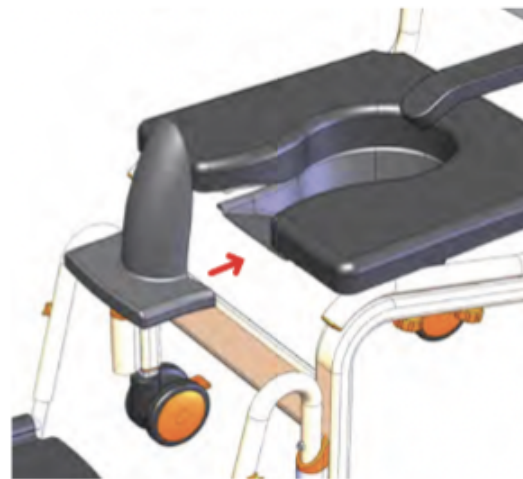

STEP 5

Adjust the Seat height . To raise or lower the seat height depress the push pin in the caster leg and move the leg up or down.

WARNING

If the push pin is not fully popping out into position DO NOT use the chair. Consult with the supplier for adjustment.

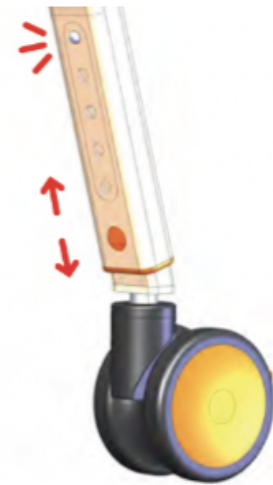

Adjust the Footrests

Adjust the footrest height to suit the user by removing the clip in the footrest cane, or unscrew the knob (depend on the chair model) and raise or lower the footplate.

Footrests can be folded up and swung away when not in use or during transfers.

WARNING

DO NOT STAND ON THE FOOTRESTS

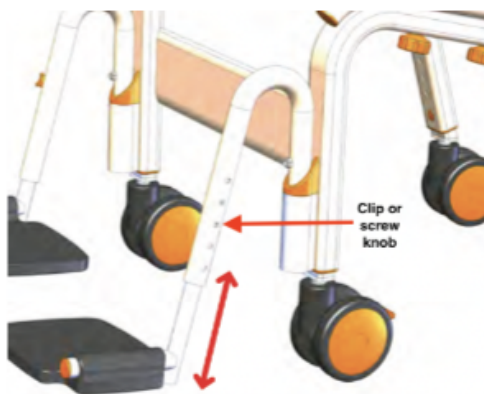

Cleaning and Maintenance

It is recommended that your shower chair is serviced annually by your Showerbuddy Dealer or an authorised, competent service agent. In addition:

1. Regularly inspect all parts of the chair for defects. Any defective part should be attended to promptly by an authorised service agent.
2. Clean the seat using a damp cloth and a mild cleanser. Always read the manufacturers instructions prior to applying the cleanser. When using Sodium Hypochlorite (Bleach) on the seat, a solution of 0.1% Sodium Hypochlorite should have no adverse effects on the cleaning of chairs. However, when using a solution of 1.0%, care should be taken to rinse the chairs thoroughly with clean water after application. Over a period of time bleaching may occur, but the integrity of the product will remain unaffected.
3. Dry off the shower chair after use.
4. Do not oil or grease any parts.
5. Keep the castors free from lime scale, soap residue and hair by cleaning after use in the shower.

Caring for stainless steel.

Stainless steel has excellent corrosion resistance, but it is not stain or rust proof. Regular maintenance will keep stainless steel clean and free of contaminants. In most applications stainless steel will not rust or stain even after many years of service, but when used in certain environments such as concentrated chlorine or other corrosive elements stainless steel requires proper care and maintenance. Do not leave stainless in contact with iron, steel or other metals.

1. Clean stainless steel frequently with soap and water. Any cleaner safe for glass is usually safe for stainless steel; apply with a cotton cloth.
2. Use a coating such as a good wax to help safeguard the stainless steel.
3. Remove discolouration or rust spots as soon as possible with a brass, silver or chrome cleaner. Irreversible pitting will develop under rust that remains on stainless steel for any period of time. Apply a mild cleaner such as Ajax or an equivalent with a wet cotton cloth. Rinse thoroughly and wipe dry. Do not use abrasives such as sandpaper or steel wool on stainless steel.
4. Do not clean with mineral acids or bleaches.
5. Do not store near any chlorine product.

safety instructions

Safety Warning!

Failure to comply with these safety instructions may result in injury or damage!

It is important that the user(s), and/or the caregivers of the user(s), learn how to safely operate the Showerbuddy shower chair.

The following must be read before use of the Showerbuddy shower chair to ensure the safe operation of your Showerbuddy shower chair:

The Owner(s) Manual must be read and understood before using the Showerbuddy shower chair.

If you don't understand any parts of the Owner(s) Manual, clarification should be sought prior to using the product.

For further clarification of any part of the Showerbuddy Owner(s) Manual call your local dealer or visit the website below.

www.shower-buddy.com

Transfers to and from the Showerbuddy shower chair can be dangerous. Consult a physical or occupational therapist to ensure safe and reliable transfer techniques are practiced. Individuals who have not learned these skills must have assistance during transfers.

Do not use the Showerbuddy shower chair for any application outside of the manufacturers intended use, this can result in damage to the shower chair and components. Not complying with the manufacturer's instructions can result in injury to the user(s) or caregiver. Showerbuddy will not be held responsible for any injury or damage resulting from the misuse or inappropriate operation of the Showerbuddy shower chair.

If any part of the Showerbuddy shower chair requires maintenance please don't hesitate to contact your dealer. Any problems that could affect the safe operation of the chair **MUST** be attended to immediately.

Safety instructions:

The **MAXIMUM USER** weight for this Showerbuddy shower chair is: **136kg (300lbs)**

ALWAYS ensure that your Showerbuddy shower chair is capable of maneuvering over the surfaces that will be encountered, prior to operating the shower chair with any user(s). This chair is only intended for use indoors, on flat surfaces, without thresholds, steps, curbs or obstacles.

ALWAYS lock the castor wheels when the chair is stationary. To do this step-on the lever that activates the wheel locks.

DO NOT STAND or step on the footrest, as the chair will tip forward possibly causing injury to the User. The footrests are not load bearing and are not intended or designed as a step.

DO NOT lean forward or sideways out of the shower chair as this may cause the chair to tip.

DO NOT wheel the shower chair down an incline without a caregiver who can control the chair during its descent.

DO NOT use the shower chair castor wheel locks as brakes when travelling down inclines.

DO NOT position the Showerbuddy shower chair sideways on a slope as this could cause it to tip.

Important!

Although every effort has been made by the Showerbuddy team to ensure the stability of the Showerbuddy shower chairs during use, it is important to recognize that the most dangerous part of using any shower chair is the transfer. If you are unsure of how to perform transfers in a way that can be performed safely, then contact a Physical or Occupational Therapist who is familiar with transfer techniques and options.

The wheel locks on the castors are designed to prevent the castor wheels from rotating when the shower chair is stationary. These **DO NOT** and **CANNOT** prevent the wheels from sliding if the floor is slippery. A slippery floor can be caused by dust, water, soap or any substance that doesn't allow the tires (tyres) to grip. Transfers should never be attempted with the Showerbuddy shower chair positioned on slippery surfaces since the wheel locks can only prevent the wheels from rotating. It is recommended that transfers be performed on clean, dry non slippery surfaces. When transferring onto a Showerbuddy Shower Chair always lock all castors in their outward position (front castors positioned in the forward and out position / rear castors positioned to the rearward and out position) for maximum chair stability.

Never use the foot rest to assist with transfers. This could cause the chair to tip forward. The footrest should be folded away during transfers to provide unobstructed access to the shower chair.

DO NOT stand on the footrest as this is designed to provide support for the user's feet while seated and not

to act as a load bearing component when the user mounts or alights from the chair. Standing on the footrests could cause the chair to tip forward.

The fasteners – Knobs, nuts, bolts, washers – should be checked periodically to ensure that they are securely fastened. Your dealer should be called to check the fasteners and other components at least once per year.

All Showerbuddy shower chairs are supplied with chest and lap restraining belts that ensure the correct and safe operation of the shower chair for both the user(s) and the caregiver. It is important that these straps are used every time the shower chair is operated. Your Showerbuddy shower chair is equipped with fitting points so that these can be easily and effortlessly attached.

Important!

ADJUSTMENTS SHOULD NEVER BE ATTEMPTED WITH THE USER(S) IN THE CHAIR!

Your authorized Showerbuddy dealer can help you with any adjustments you may want to make on your Showerbuddy shower chair or can provide clarification on any of the information contained herein.

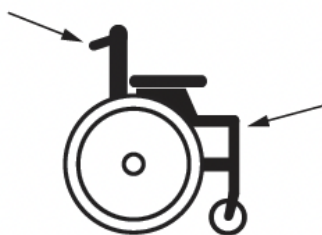

How to lift the chair

Lift the wheelchair up using the push handles and the front upper corners of the wheelchair frame, where the footrests are placed.

WARNING! It is not allowed to lift the wheelchair up by gripping the footrests or armrests! We recommend to detach footrests before lifting the chair

SHOWERBUDDY WARRANTY

CHAIR FRAME

- **Lifetime warranty against corrosion of Structural Frame parts.**
- **2-year warranty against manufacturing defects of original parts.**

ALL OTHER COMPONENTS

- **1-year warranty against manufacturing defects of original parts.**

WARRANTY CONDITIONS

- **The Warranty period starts from the customer purchase date and ends as above.**
- **Any claim made must include the chair serial number, image of the problem and proof of purchase by the customer.**
- **Any claim should be submitted to the retail store or mobility equipment supplier from where the chair was purchased. If the store is unable to service the chair, and the above conditions have been adhered to, parts will be provided by Showerbuddy directly to the chair owner with freight payable by the owner.**

International Office

Showerbuddy New Zealand Ltd

Wellington 6021

New Zealand

For all enquiries

Email: admin@shower-buddy.com

shower-buddy.com

showerbuddy**®**

ACCESS YOUR BATHROOM WITHOUT A REMODEL

**Designed in
New Zealand**



All ShowerBuddy products are CE, TUV, ISO9001 and TGA certified and comply with AS-NZS 3973.
Copyright © 2023 by Showerbuddy New Zealand Ltd, New Zealand. e:admin@shower-buddy.com

All rights reserved