

# INFLATABLE EVENT EQUIPMENT

## TENTS

EASY	6
LITE	8
SQARE	10
TRIPOD	12
HEXA	14
CUBE	16
SPIDER	18
FLOWER	20



## SHAPE

ANGLED	24
ROUNDED	26
ZIP-OFF	28
TUBE	30
CAN	32
BOTTLE	34
BLOCK	36
WALL	38
FLOAT	40



## FURNITURE

TABLE	44
DESK	46
SEAT	48
CHILLOUT	50





# TENTS

the widest range  
of inflatable  
event tents



## HIGH QUALITY TPU SEALED TUBES

All AXION tents are use 250mic seamless TPU bladder tubes ended by using HF welding technologies. All bladders are accommodated in strong 500D HT polyester, so the whole inflatable structure is rigid, but still flexible in a wide temperature range from cold FIS SKI events to the hot DAKAR RALLY.



## SMART INFLATION SYSTEM

Patented one way central inflation system provides the luxury of one point inflation with perfect control of inflation from chamber to chamber. It also provides easy detection of eventual air leak. Smart inflation system is now included in most of AXION models.

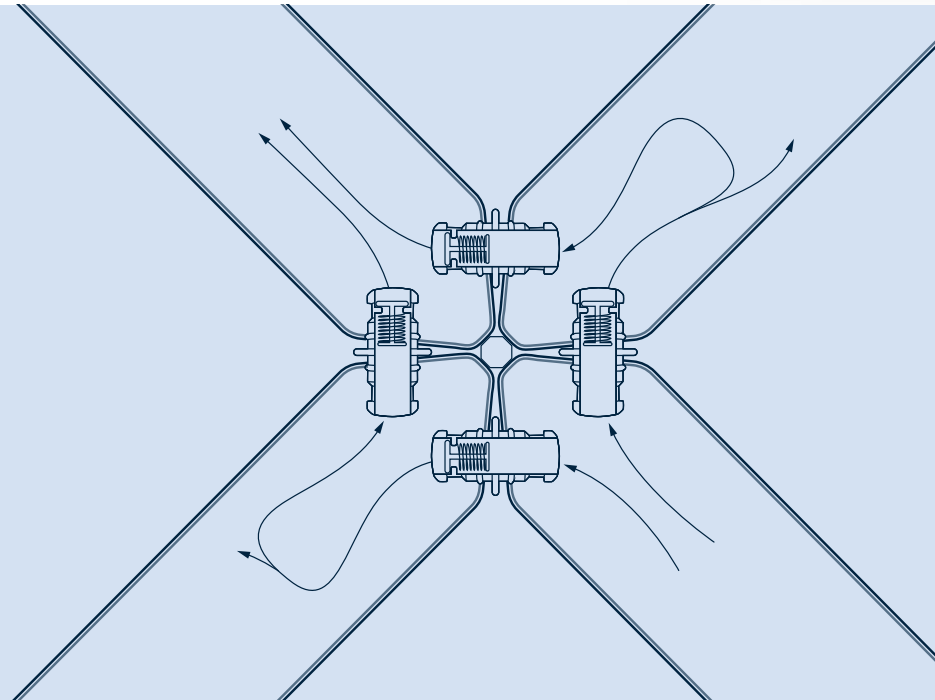

## FULLY SERVICEABLE BY USER

It is a life. Usually you get some damage at the moment, when you need your tent up. If there is ever damage done to your tent, a repair kit is available for all AXION models. Thanks to the zip-off roof and the central tube connector, any user can change the inflatable tube onsite within a few minutes without having to send the tent out for service!

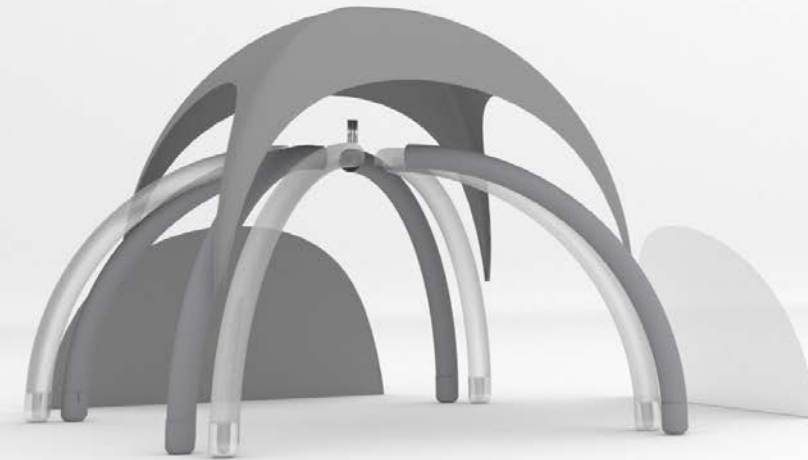

## EXTREME SAFETY

In comparison to metal structure tents there are no dangerous rigid components. In comparison to the old fashioned inflatable tents with permanent blower, sealed inflatable tents or also so called pneumatic tents are independent of power grid. AXION is one of the safest pneumatic tents on the market. Tested for up to 100 km/h and certified for 60 km/h, it can withstand the most extreme of weather conditions. The structure is very flexible and will keep those in the tent safe during strong winds. AXION is designed to bend and twist with the wind and back to its original shape.



## MODULARITY

All sizes of each AXION model can be connected together by tunnels, so a tent village can be created. More over, some sizes of different AXION models can be interconnected by tunnels too.

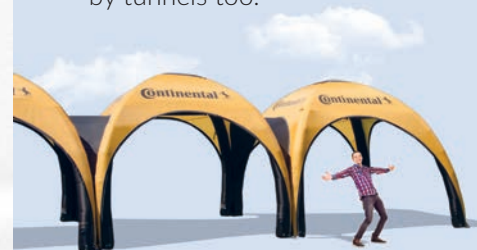

## REVERSIBLE WALLS

All walls are reversible. You can also get double walls with an opaque layer inside, panorama walls, section walls and more.



## EASY TRANSPORT

Packed in an original trolley bag, each AXION tent can be easily transported in any personal car. This is a great advantage of inflatable tents in comparison to metal tents.





# EASY

basic model of promotional inflatable tent

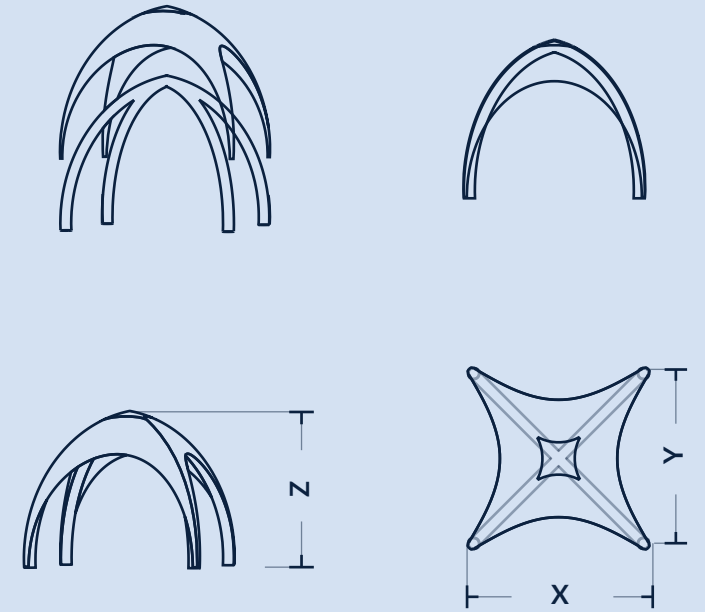

## CONCEPT

AXION Easy is a high quality inflatable tent with simplified structure, respecting financial limits of our clients. Even with limited budget it provides them an opportunity to use a quality brand inflatable tent, made in the EU, without compromises.

An EASY model is an easy concept of four independent inflatable legs nicely forming a roof with a place for four artworks to be printed by sublimation printing without color limits. Similar to other AXION models, there is a possibility to use different branded roofs with one structure, easily changeable by the zip-off technology for better promotion. The zip-off cover, walls, visors and the entire inflatable structure can be printed in full color dye sublimation upon demand.

	easy33	easy44	easy55	easy66
width "X" (cm)	330	400	500	600
length "Y" (cm)	330	400	500	600
height "Z" (cm)	285	290	350	420
Covered area (m2)	11	16	25	36
weight (kg)	20	25	30	42
app. time	0:10	0:10	0:15	0:20
person	1	1	1	1-2
Dye sublimation print		roof/walls/structure		
material		polyester / TPU		
flame retardancy		EN 13501-1		





# LITE

high quality  
inflatable  
promotional tent  
for every budget

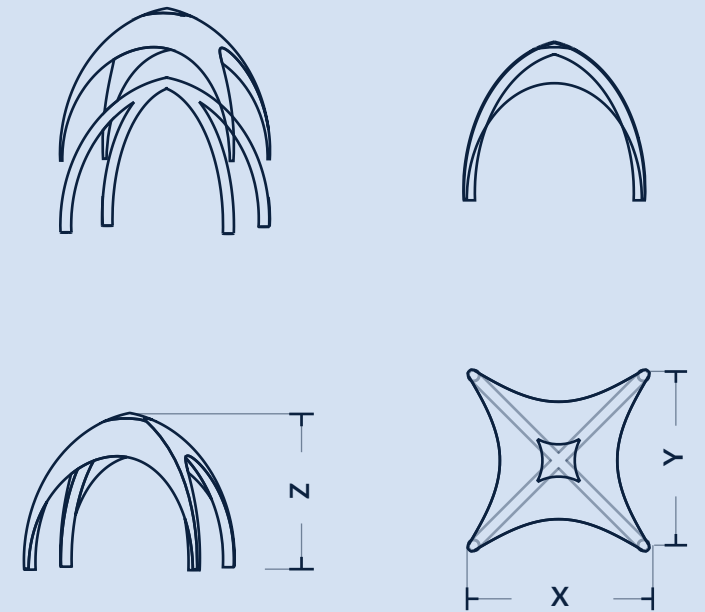

## CONCEPT

The aim with creation of AXION LITE was to provide an easy, budget friendly, but high quality inflatable promotional tent to the market. The LITE model is a simple concept of four sealed inflatable legs forming a roof with a place for four artworks to be printed using sublimation printing without color limits. Brand managers appreciate the option of using different branded roofs with one structure, easily changeable using the zip-off technology for better promotion. The zipoff cover, walls, visors and the entire inflatable structure can be printed in full color dye sublimation upon demand.

## HANDLING and SET UP

The AXION LITE is made of strong, yet lightweight polyester fabric. Using patented AXION Smart Inflation System (that controls the airflow using the central valves system), requires one person to set up within minutes. The entire dome packs down into the original trolley bag that fits into any standard sized car, making it perfect for any roadshow or event.

	lite33	lite44	lite55	lite66
<b>width "X" (cm)</b>	330	400	500	600
<b>length "Y" (cm)</b>	330	400	500	600
<b>height "Z" (cm)</b>	285	290	350	420
<b>Covered area (m2)</b>	11	16	25	36
<b>weight (kg)</b>	20	25	30	42
<b>app. time</b>	0:10	0:10	0:15	0:20
<b>person</b>	1	1	1	1-2
<b>Dye sublimation print</b>		roof/walls/structure		
<b>material</b>		polyester / TPU		
<b>flame retardancy</b>		EN 13501-1		





# SQUARE

sealed inflatable event tent using horizontal inflatable beams

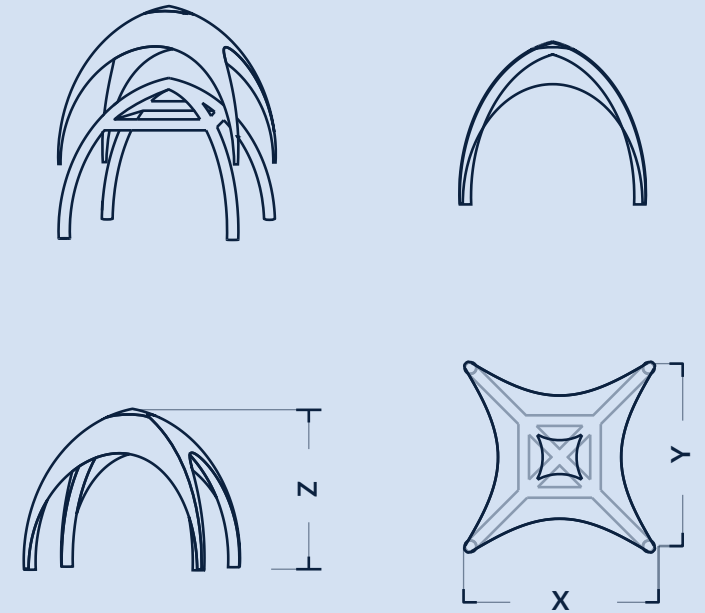

## CONCEPT

As the first member of the AXION family (created in 2010) the AXION SQUARE carries signature features of the AXION brand, like the horizontal stabilization inflatable beams, the central tube connector, the zip-off roof, and its availability in 4 sizes, which makes it one of the most reliable inflatable event tents on the market.

Brand managers love the option of being able to use different branded roofs with one structure, easily changeable by the zip-off technology. The zip-off cover, walls, visors and the entire inflatable structure can be printed in full color dye sublimation on demand.

## WEATHER RESISTANCE

AXION SQUARE is proven to withstand winds up to 100 km/h, ranking the AXION product as one of the safest inflatable tents on the market.

square44

square55

square66

square77

	square44	square55	square66	square77
<b>width "X" (cm)</b>	400	500	600	700
<b>length "Y" (cm)</b>	400	500	600	700
<b>height "Z" (cm)</b>	290	350	420	490
<b>Covered area (m2)</b>	16	25	36	49
<b>weight (kg)</b>	30	35	50	66
<b>time</b>	0:10	0:14	0:17	0:20
<b>Dye sublimation print material</b>	roof/walls/structure polyester / TPU			
<b>flame retardancy</b>	EN 13501-1			





# TRIPOD

open space  
inflatable  
shade for car  
promotion

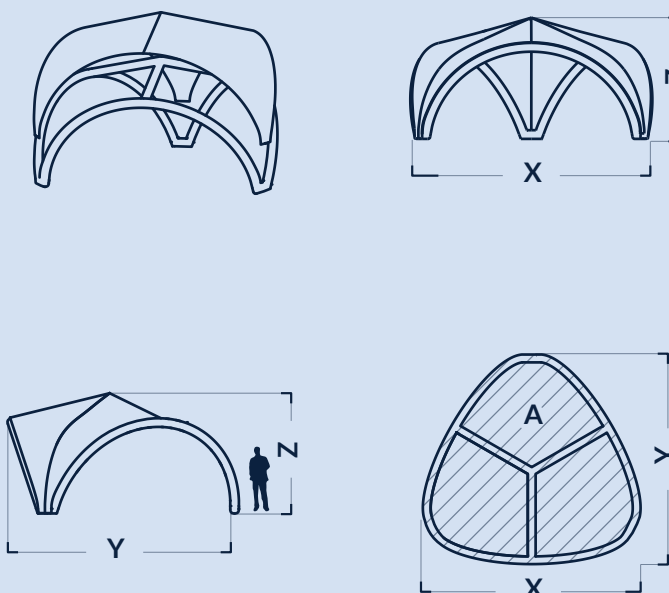

**CONCEPT** - AXION TRIPOD is a great concept for both indoor and outdoor events as an inflatable podium cover, promotional tent or as a stylish sun shade. A zip-off roof and side walls can be sublimation printed. Enjoy it's innovative shape and airy design.

**COVER AREA** - The canopy of TRIPOD shade is made of water resistant fabric, so there is no need to add the water proof layer in case of rain. Thanks to the negative sloped side walls, the efficient usage area is much larger. There is no need to use additional visors, as the internal space is unaffected by rain or sun. More over, it is possible to connect more TRIPODS by tunnels to create an extraordinary tent village.

**HANDLING** - As with our other AXION pneumatic tents, handling is very easy. The TRIPOD is packed into a trolley bag and is easily transportable in any personal car. Just one person can transport and inflate it within minutes by one valve using patented AXION Smart Inflation System.

**SERVICE** - Thanks to the zip-off roof and the central tube connector, any user can change the inner bladder or whole inflatable arch onsite within a few minutes without having to send the tent out for service!

	tripod6	tripod7	tripod8	tripod9
<b>width "X" (cm)</b>	600	700	800	900
<b>length "Y" (cm)</b>	600	700	800	900
<b>height "Z" (cm)</b>	320	370	430	480
<b>covered area "A" (m2)</b>	25	34	45	58
<b>weight (kg)</b>	32	46	60	77
<b>app. time</b>	0:10	0:15	0:20	0:25
<b>person</b>	1	1	1-2	2
<b>dye sublimation print</b>			roof/walls	
<b>material</b>			polyester / TPU	
<b>flame retardancy</b>			EN 13501-1	

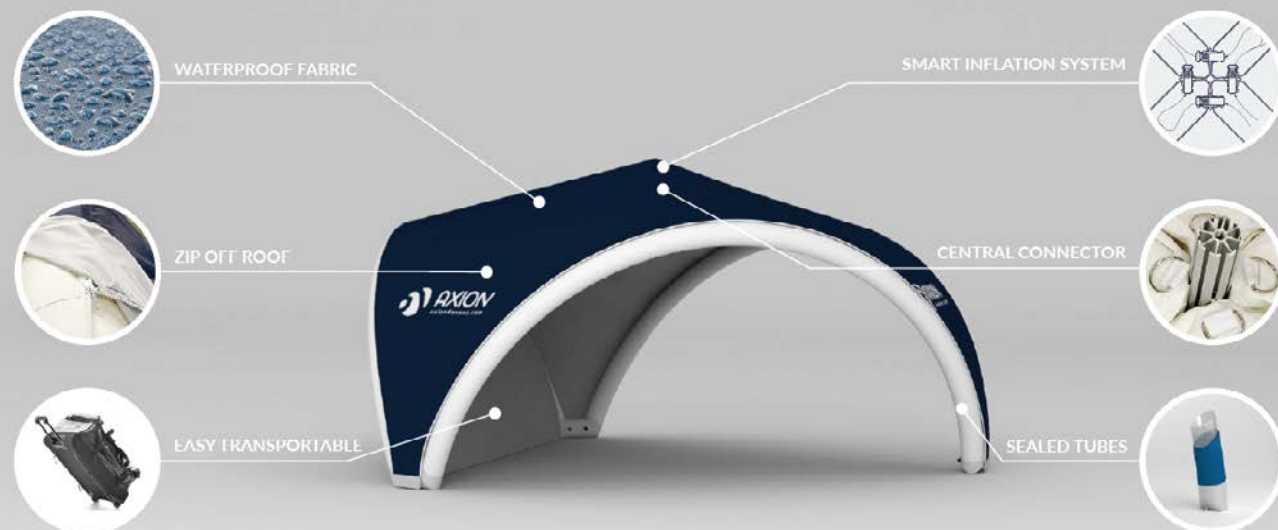



# HEXA

wide space  
hexagonal  
inflatable tent

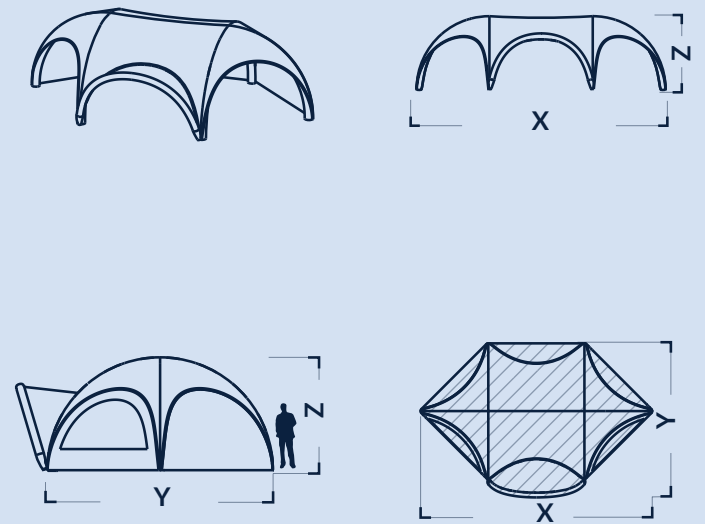

## CONCEPT

The primary idea was to offer wider space inside to all those who do not wish to connect two tents together with a connection tunnel. AXION HEXA meets this task perfectly, without creation of funnel in the middle of the internal space. Similar to the SQUARE model, HEXA is equipped with horizontal beams to provide better side stability.

## COVER AREA, HANDLING and SET UP

According to the diagram, HEXA covers up to 56m<sup>2</sup>. Even at this size, two people can easily inflate it within minutes. The entire dome packs down into the original trolley bag that fits into any standard sized car, making it perfect for any roadshow or event.

hexa44

hexa55

<b>width "X" (cm)</b>	950	1155
<b>length "Y" (cm)</b>	555	685
<b>height "Z" (cm)</b>	290	350
<b>built area (m<sup>2</sup>)</b>	38	56
<b>weight (kg)</b>	52	65
<b>dye sublimation print</b>		roof/walls
<b>material</b>		polyester / TPU
<b>flame retardancy</b>		EN 13501-1

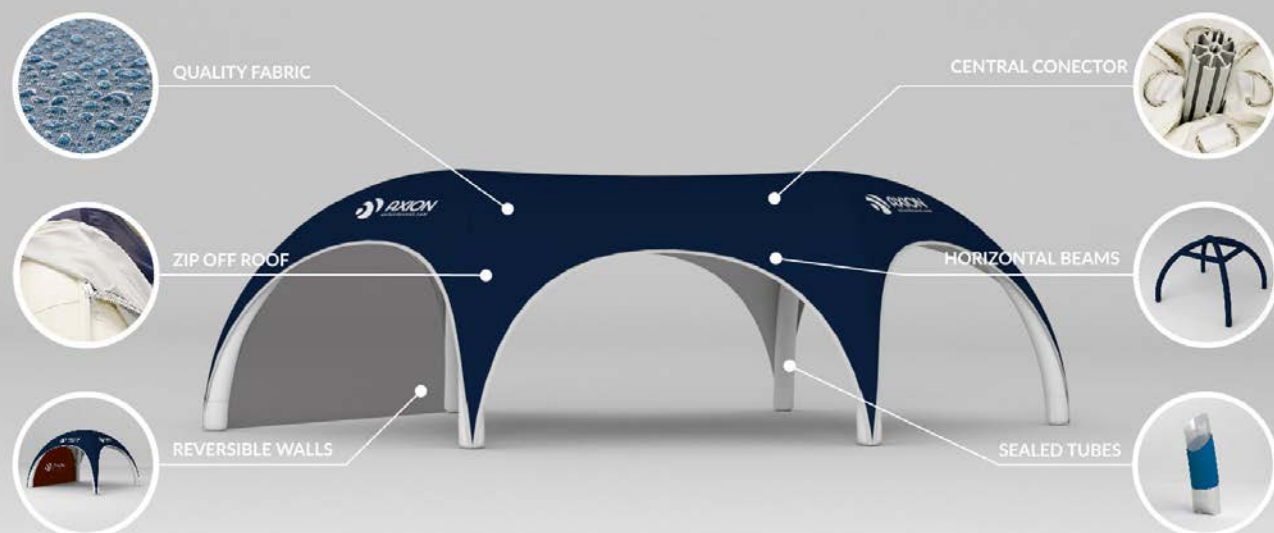



# CUBE

pure form  
inflatable event  
tent

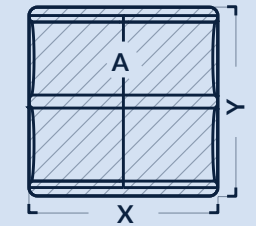
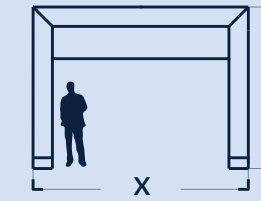
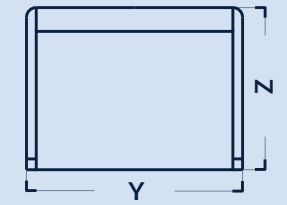
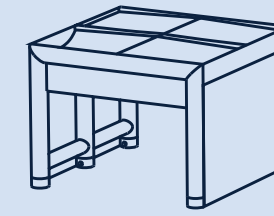

## CONCEPT

CUBE is a solution for all those fed up with traditional inflatable or pop up tents. Thanks to a unique solution (hidden water drain), the roof can stay optically flat and works perfectly outdoor in any rain conditions. As with all AXION products, there is no need for permanent power supply!

## DESIGN

CUBE is a unique inflatable tent designed in a modern cubist style. Different from any other inflatable tent, it offers straight vertical panels - perfect for your branding.

## HANDLING and SET UP

The AXION CUBE is made of strong yet lightweight polyester fabric. An installation requires just one person to set up within minutes. The entire dome packs down into the original trolley bag that fits into any standard sized car, making it perfect for any roadshow or event.

cube3

cube4

cube5

	cube3	cube4	cube5
<b>width "X" (cm)</b>	300	400	500
<b>length "Y" (cm)</b>	300	400	500
<b>height "Z" (cm)</b>	290	350	430
<b>occupied area "A" (m2)</b>	9	16	25
<b>effective area (m2)</b>	9	16	25
<b>weight(kg)</b>	20	25	30
<b>time</b>	0:10	0:15	0:20
<b>person</b>	1	1	1-2
<b>dye sublimation print</b>		roof/walls/structure	
<b>material</b>		FASTEX 100% polyester / TPU	
<b>flame retardancy</b>		EN 13501-1	



INDOOR & OUTDOOR USE

ONE POINT INFLATION

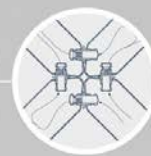

ZIP OFF ROOF

STRAIGHT DESIGN



REVERSIBLE WALLS

SEALED TUBES





# SPIDER

increase your event space with a spider dome

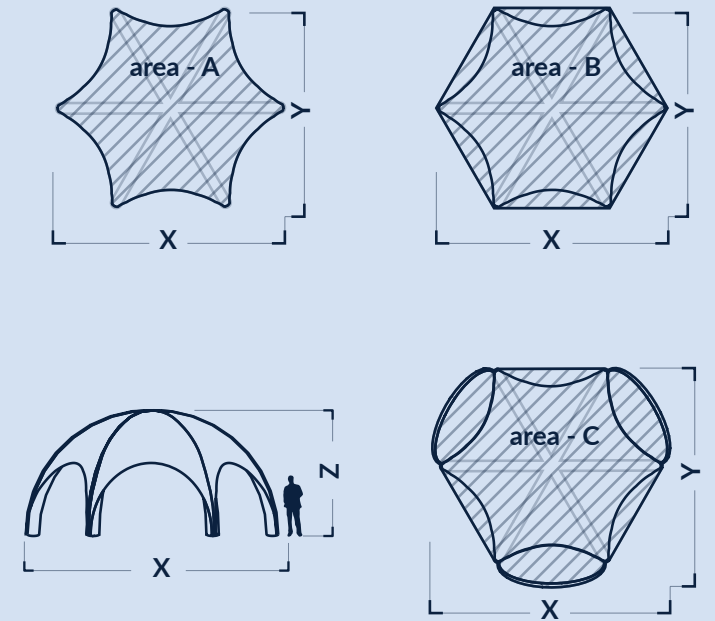

**CONCEPT** - Based on the traditional Spider inflatable dome concept, AXION SPIDER is a combination of a big hexagonal shape dome and the unique AXION system of sealed structures. SPIDER provides a big space and high wind resistance, thanks to more inflatable structure elements. Additionally, it is the only Spider tent on the market available with inflatable visors. All of this without the necessity for permanent power supply!

**COVER AREA** - SPIDER is ideal for large events looking for a contemporary and unique design. It offers a floor space of 42m<sup>2</sup> up to 80 m<sup>2</sup>. Available in a range of sizes and options including zip-off reversible walls, optional visors and branding that would meet your event requirements. A variant of SPIDER 10 with 3 visors (occupying a space of 74 m<sup>2</sup>) provides a contemporary solution which conforms to the legal requirements in most countries (no necessity for local building permissions). The SPIDER is engineered to amaze with the added ease of setting up.

**HANDLING and SET UP** - SPIDER is made of strong yet lightweight polyester fabric with contoured legs. Using our AXION Smart Inflation System (that controls the airflow using the central valves system), requires no more than 2 people to set up and will take less than 20 minutes to assemble. The entire dome packs down into a compact carry bag that fits into any standard sized car, making it perfect for any roadshow or event.

	spider8	spider10
width "X" (cm)	800	1000
length "Y" (cm)	690	860
height "Z" (cm)	420	490
Covered area A / B / C	35 / 42 / 47	54 / 66 / 74
weight (kg)	53	70
time	0:15	0:20
person	2	2
dye sublimation print	roof/walls/structure	
material	polyester / TPU	
flame retardancy	EN 13501-1	





# FLOWER

symbiosis of the design and a technology

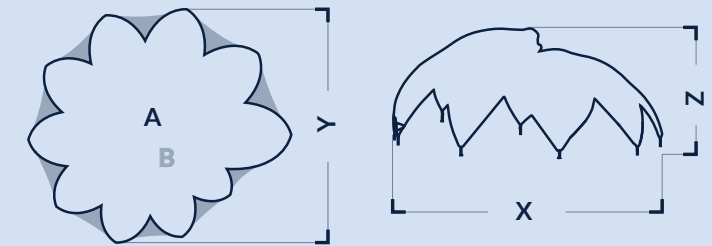
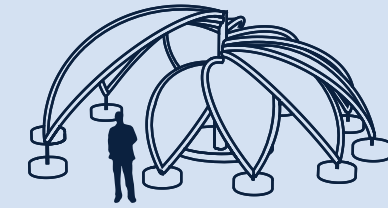

**DESIGN** - The AXION FLOWER is a unique inflatable structure inspired by nature, to bring a fresh new emotion to the traditional event stand industry. The symmetric shape allows fresh air inside with added weather protection from optional triangle shaped inserts. Each petal is an individual part of the structure with individual branding opportunity that can help you make a breath-taking visual impact.

**HANDLING** - Each size variant of the FLOWER is transportable in a van. Depending on its size, a team of 3 to 6 people can completely build it within 3 to 5 hours, depending on terrain and personal experience.

**TECHNOLOGY** - The FLOWER is a combination of three materials. The shape of the petals is guaranteed by a patented system of high pressure pneumatic tubes, inflated to nominal pressure 2,0 bar (10x more than standard pneumatic structures).

**WEATHER RESISTANCE** - The FLOWER is certified according to Eurocode norm for wind up to 100 km/h. In case of thunderstorm or strong wind, the central pole can be retracted to decrease total height of the whole structure by 1,3m. Water floating to the center is drained through central gutter. Optional triangle shades are protecting the inside area against water, as well as giving more shade, increasing efficient size of of the dome by 15%.

	10PRO	12PRO	14PRO	10LITE	12LITE	14LITE
<b>width "X" (m)</b>	10,8	12	14	10,8	12	14
<b>length "Y" (m)</b>	8,6	10,3	12	8,6	10,3	12
<b>height "Z" (m)</b>	4,3	5,2	6	4,0	4,8	5,6
<b>covered area petals only A(m2)</b>	52	82	109	52	82	109
<b>covered area triangle shades B(m2)</b>	64	94	125	64	94	125
<b>st. structure weight</b>	1100	1150	1200	350	400	450
<b>petals weight</b>	400	450	500	400	450	500
<b>water ballast</b>	3000	3500	4000	0	0	0
<b>installation time (hours)</b>	3-4	3,5-4,5	4-5	4-5	4,5-5,5	5-6
<b>installation person</b>	3-4	3-5	4-6	3-4	3-5	4-6

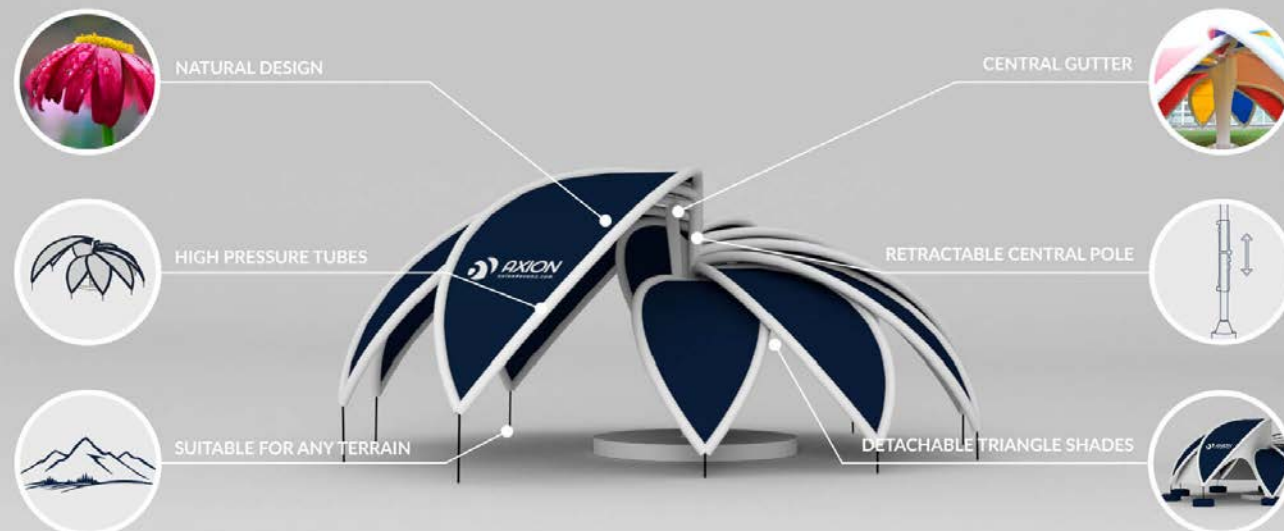



# SHAPE

sealed inflatable  
event objects



## HIGH QUALITY TPU SEALED TUBES

All AXION tents use 250mic seamless TPU bladder tubes finished using HF welding technologies. All bladders are accommodated in strong 500D HT polyester, so the whole inflatable structure is rigid, but still flexible in a wide temperature range from cold FIS SKI events to the hot DAKAR RALLY.



## INTERNAL ILLUMINATION

Take the opportunity to use an internal illumination to the AXION products. Both 230V plug or 12V unplug systems are available in white or RGB version. Thanks to using modern flat LED sources connected to compact click-in Li-Ion batteries, an illumination of the AXION products is easy to be used and effective for any night event.



## SMART INFLATION SYSTEM

Standard inflatable arches are fully dependent on the power source. In a case of power outage an unpleasant or even dangerous situation can occur. Sealed AXION Arches are independent of power and more weather stable as they are inflated to higher pressure. For double safety each arch can be equipped with an automatic pressure control system.

## FULLY SERVICEABLE BY USER

That's life! The moment you need your structure up and running, odds are some damage will occur. If there is ever damage done to your Shape object, a repair kit is available for all AXION models. Thanks to the easy zip-in system, any user can repair or change the inflatable tube on-site within a few minutes without having to send the object out for service!



## COLORS WITHOUT LIMITS

For AXION Shape objects we use the newest technologies in dye sublimation printing, automatic cutting and welding, so each object can have different full color design.



## EXTREME STABILITY

A ballast plate, a ballast bag or even a combination can be used as an accessory to any of the AXION Shape products.



## EASY TRANSPORT

The base of each AXION Shape object works as a transport bag. Just deflate the object and zip-on the top part.





# ARCH ARE

sealed  
pneumatic arch  
angled shape

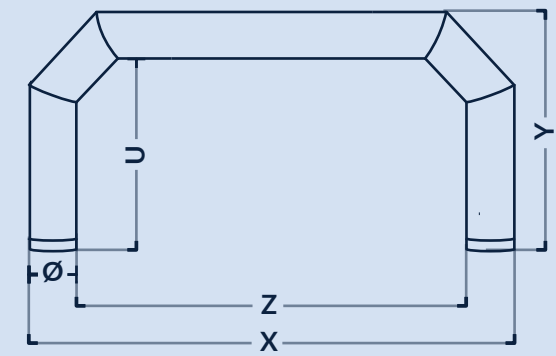

AXION Inflatable Arches are slimmer than traditional arches due to their higher internal pressure. It has better weather resistance, better stability, no collapse risk and no

Angled Inflatable Arch is the most common arch shape for sport events, offering big space for branding. AXION Pneumatic Arch is our variant of the angled shape, already well tested at hundreds of events in many countries around the world.

ARE 400-48t    ARE 500-60    ARE 600-60    ARE 600-80    ARE 800-60    ARE 800-80

width inner "Z" (cm)	304,0	380,0	480,0	440,0	680,0	640,0
width outer "X" (cm)	400,0	500,0	600,0	600,0	800,0	800,0
height inner "U" (cm)	212,0	260,0	320,0	300,0	350,0	380,0
height outer "Y" (cm)	260,0	320,0	380,0	380,0	410,0	460,0
tube diameter "Ø" (cm)	48,0	60,0	60,0	80,0	60,0	80,0
weight (kg)	30,0	35,0	40,0	44,0	46,0	47,3

ARE 800-96    ARE 1000-80    ARE 1000-96    ARE 1000-96H    ARE 1200-96    ARE 1200-96H

width inner "Z" (cm)	608	840	808	808	1008	1008
width outer "X" (cm)	800	1000	1000	1000	1200	1200
height inner "U" (cm)	384	400	384	489	384	489
height outer "Y" (cm)	480	480	480	585	480	585
tube diameter "Ø" (cm)	96	80	96	96	96	96
weight (kg)	51,7	50,5	59,5	63	63,4	66,6

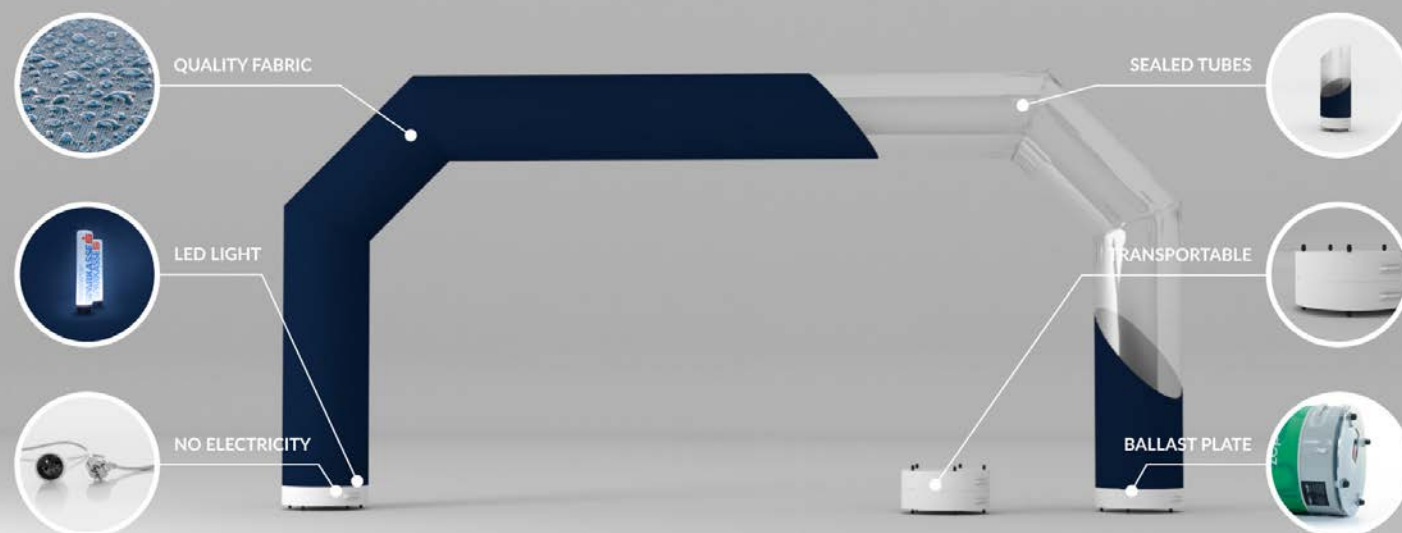



# ARCH ARR

sealed  
pneumatic arch  
rounded shape

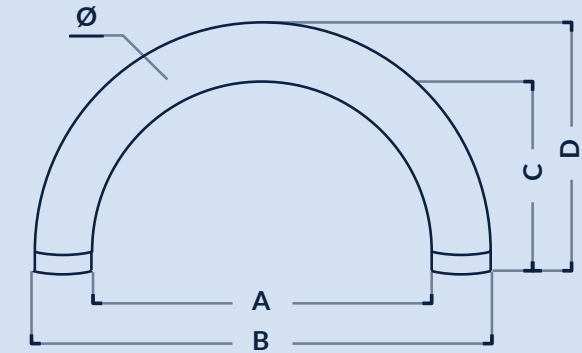

AXION Pneumatic Arches are slimmer than traditional arches due to their higher internal pressure. It has better weather resistance, better stability and no blower noise. Most of our customers choose AXION Arches for their easy installation and safety in use.

The AXION Round Arch provides attractive gate and entrance way to sporting events and festivals. However, with difficult artwork applications, this product is better suited to graphics of a simple nature.

ARR 600-80

ARR 800-96

ARR 1000-96

	ARR 600-80	ARR 800-96	ARR 1000-96
<b>width inner "A" (cm)</b>	440,0	608,0	808,0
<b>width outer "B"(cm)</b>	600,0	800,0	1000,0
<b>height inner "C" (cm)</b>	300,0	384,0	429,0
<b>height outer "D"(cm)</b>	380,0	480,0	525,0
<b>tube diameter "Ø"(cm)</b>	80,0	96,0	96,0
<b>weight (kg)</b>	44,0	51,7	59,5





# ZIP-OFF

multifunctional arch with detachable horizontal beam

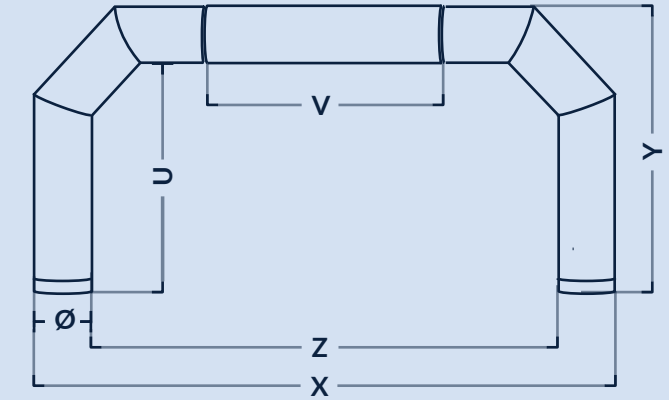

AXION Arches are slimmer than traditional arches due to their higher internal pressure. It has better weather resistance, better stability, no collapse risk and no blower noise. Most of our customers choose AXION Arches for their easy installation and safety in use.

Zip-off Arch is a unique solution for all those using their arch at small events, as well as events where organizers are not allowing full arches due to security reasons. The horizontal beam can be detached and used separately as a vertical or horizontal tube, while the vertical corners work well as half-arches.

	ARH X-60	ARH X-80	ARH X-96	ZIP-OFF 800-80	ZIP-OFF 1000-96
<b>width inner "Z" (cm)</b>	-	-	-	640,0	808,0
<b>width outer "X" (cm)</b>	170,0	223,0	300,0	800,0	1000,0
<b>height inner "U" (cm)</b>	-	-	-	300,0	300,0
<b>height outer "Y" (cm)</b>	320,0	380,0	480,0	380,0	480,0
<b>tube diameter "Ø" (cm)</b>	60,0	80,0	96,0	80,0	96,0
<b>weight (kg)</b>	14,0	18,0	25,0	50,0	62,7





# TUBE

sealed inflatable  
tube simple  
and versatile  
inflatable object



AXION Inflatable Tubes are slimmer than traditional inflatable tubes due to their higher internal pressure. It has better weather resistance, better stability and no blower noise. Most of our customers choose AXION Tubes for their easy installation and safety in use.

AXION Tubes are available in many sizes, but always with the option of simple artwork change by zip-off sock cover. Our customers also appreciate the option of internal illumination and stability with an optional ballast plate. AXION Tube is a simple and reliable product.

	TU 250-38	TU 250-48	TU 300-38	TU 300-48	TU 300-60	TU 400-48
height total "Y" (cm)	250	250	300	300	300	400
height (cm)	230	230	280	280	280	380
diameter "Ø" (cm)	38	48	38	48	60	48
weight (kg)	5	6	7	8	9,1	9

	TU 400-60	TU 400-80	TU 500-60	TU 500-80	TU 500-96
height total "Y" (cm)	400	400	500	500	500
height (cm)	380	380	480	480	480
diameter "Ø" (cm)	60	80	60	80	96
weight (kg)	10,6	15	12,1	16,8	25



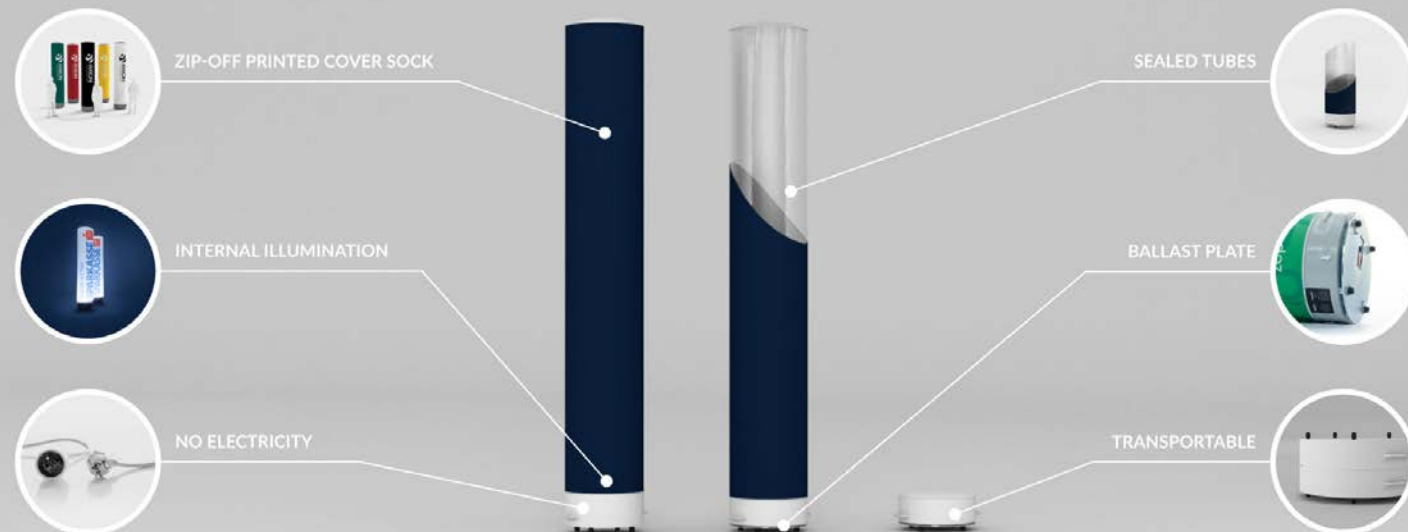

# CAN

shows your drink  
in its real shape

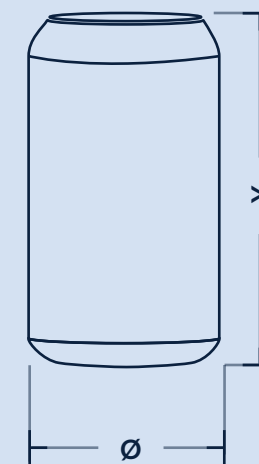

AXION Inflatable Can has the same principle as the AXION Tube, but is patterned in a can shape. It is a sealed inflatable with an internal bladder and higher internal pressure than traditional inflatable cans. It has better weather resistance, better stability and no blower noise.

AXION Cans are available in many sizes and custom shapes. Our customers also appreciate the option of internal illumination and stability with an optional ballast plate.

CA 200-80

CA 240-96

CA 300-120

	CA 200-80	CA 240-96	CA 300-120
height "Y" (cm)	200,0	240,0	300,0
diameter "Ø" (cm)	80,0	96,0	120,0
weight (kg)	8,0	16,0	22,0

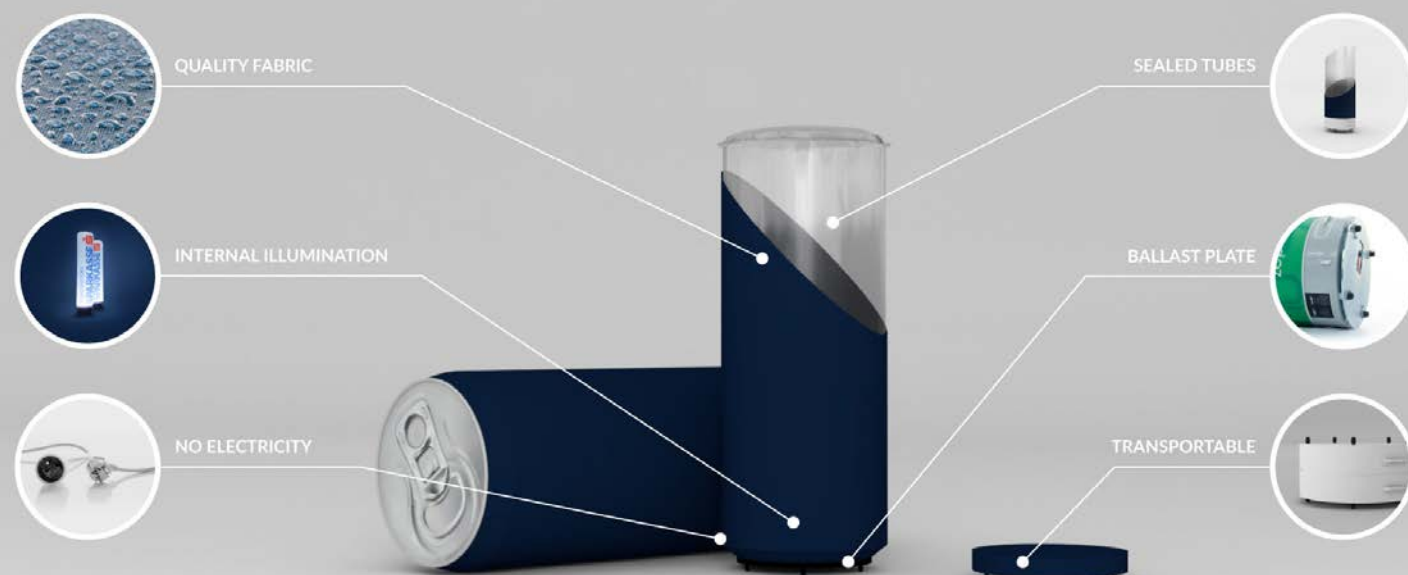



# BOTTLE

shows your drink  
in its real shape

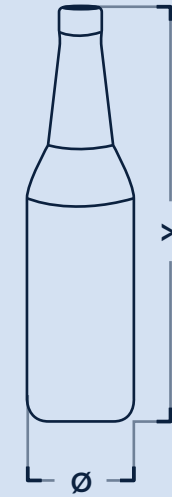

AXION Inflatable Bottle has the same principle as a tube, but is patterned in a bottle shape. It is a sealed inflatable with an internal bladder and higher internal pressure than traditional inflatable bottles. It has better weather resistance, better stability and no blower noise.

AXION Pneumatic Bottles are available in sizes up to 4m and customizable shapes. Our customers also appreciate the option of internal illumination and stability with an optional ballast plate.

	BO 200-55	BO 250-65	BO 300-80	BO 400-110
height "Y" (cm)	200,0	250,0	300,0	400,0
diameter "Ø" (cm)	55,0	65,0	80,0	110,0
weight (kg)	5,0	8,0	11,0	13,2

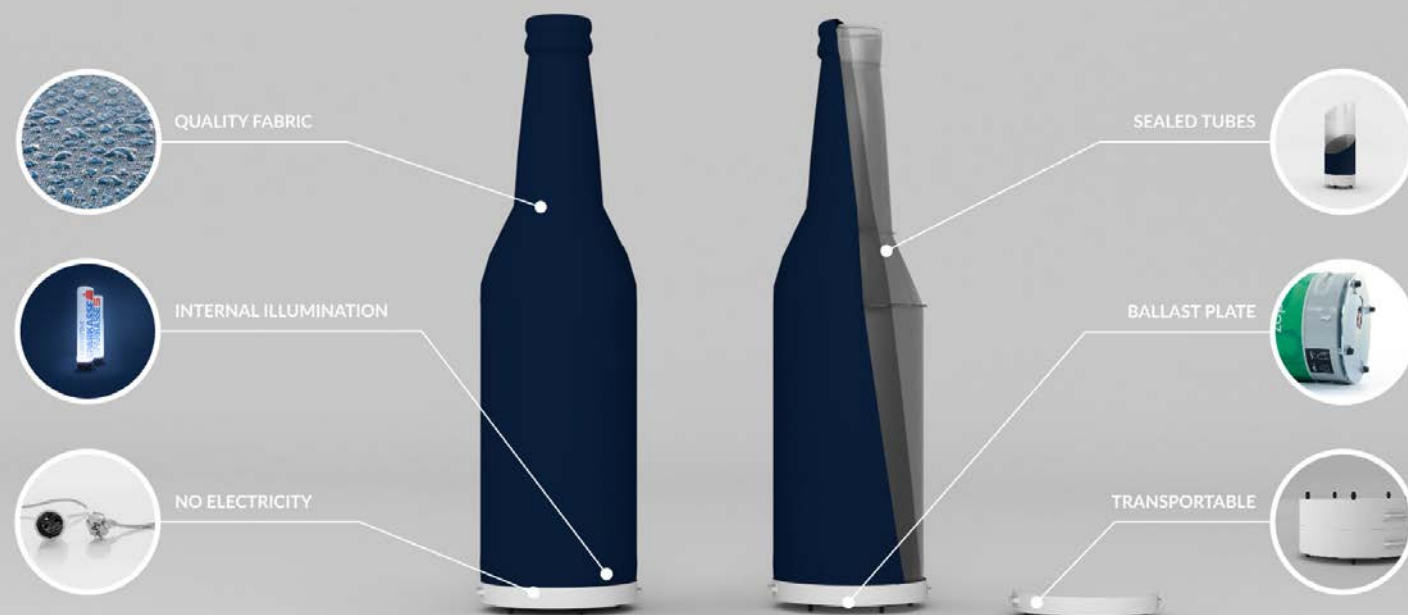



# BLOCK

flat pneumatic  
objects using  
ribbed bladders

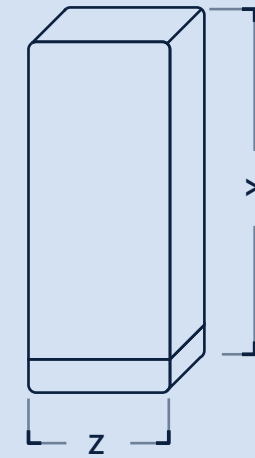

All inflatable objects of the AXION Block category use ribbed bladders, which provide the rectangular shape of this object with a flat surface for your artwork. Inflatable Blocks are suitable for all those who do not like traditional shaped inflatables, or prefer simple, flat surfaces to promote their brand.

AXION Pneumatic Blocks are available in many sizes, but always with an option of simple artwork change by zip-off sock cover. As with other AXION Shape products, customers can enjoy perfect stability with an optional ballast plate.

BL 250-60

BL 300-75

BL 400-100

height total "Y" (cm)	250,0	280,0	380,0
height (cm)	230,0	300,0	400,0
base size "Z" (cm)	60x60	75x75	100x100
weight (kg)	9,0	13,0	16,0

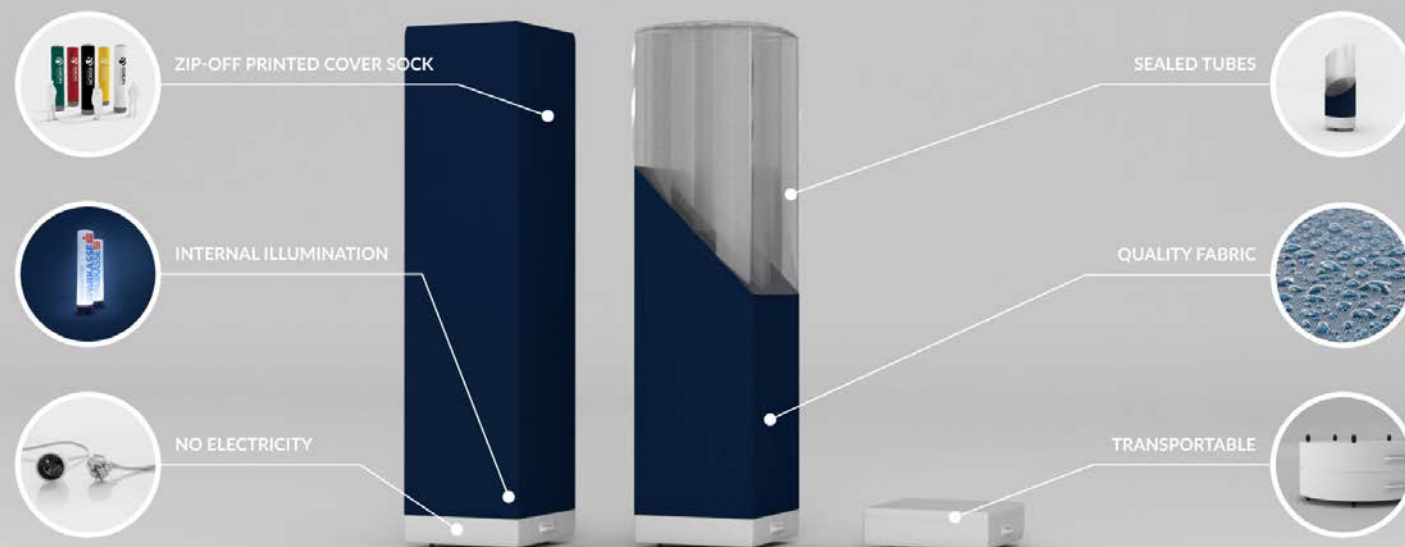



# POP-UP

display wall -  
slim and rigid  
inflatable display

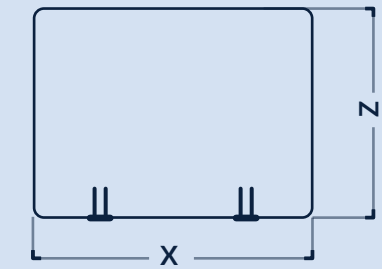
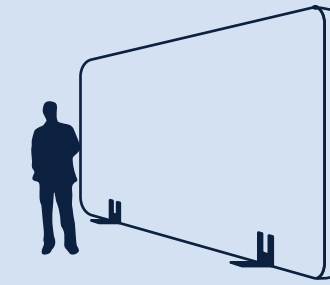

The AXION Wall brings the advantage of pop-up display in combination with sealed inflatable technology, suitable for indoor and outdoor use. Using drop-stitch fabric technology with high pressure inside, after proper anchoring it is able to withstand the same wind as heavy duty solid display with an added advantage - this display is inflatable! For indoor use, there are laser cut feet available, making the whole wall self standing without noise of a fan. As an option there's the possibility of installing LED lights to the top edge of the wall.

The wall is available in 3 size variants with fully dye sublimation printed "sock" or banners.

It is possible to save money by using different "socks" per one wall. This product is perfectly suitable for all kinds of advertising or sport events, as an inflatable billboard, sponsor wall or photoshooting wall.

## WALL 250-320

## WALL 250-410

## WALL 300-410

<b>height (cm)</b>	250,0	250,0	300,0
<b>width (cm)</b>	320,0	410,0	410,0
<b>depth (cm)</b>	10,0	10,0	10,0
<b>Display weight (kg)</b>	23,0	30,0	35,0
<b>Weight incl. bag and accessories (kg)</b>	39,0	46,0	51,0





# FLOAT

inflatable buoys  
- stable floating  
race markers

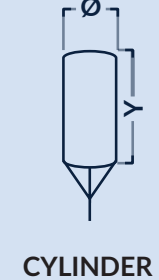
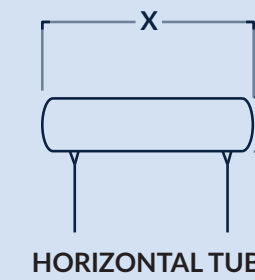
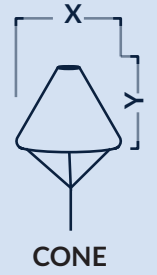

AXION Float creates a special category among AXION products due to its specific purpose. In this category you can choose different shapes and sizes of high quality sealed buoys for all water sports, such as triathlon, aquathlon, sail or boat races etc.

All popular shapes such as Cube, Cylinder, Pyramide, Cone or Sausage tube are available. AXION Floating Buoys are made of heavy duty PVC coated fabric with all over printing possibility.

	FCU 100	FCU 150	FCU 200	FCU 250	FCU 300	FPY 100	FPY 150	FPY 200	FCO 150	FCO 230
<b>width "X" (cm)</b>	cube					pyramide			cone	
	100	150	200	250	300	100	150	200	150	230
<b>height "Y" (cm)</b>	100	150	200	250	300	100	150	200	100	150
<b>digital print</b>	possible									

	FCY 150	FCY 200	FCY 250	FCY 300	FTU 040	FTU 050	FTU 075	FTU 100
<b>width "X" (cm)</b>	cylinder				horizontal tube			
	150	200	250	300	500	300	450	600
<b>height "Y" (cm)</b>	100	100	150	150	40	50	75	100
<b>digital print</b>	possible							

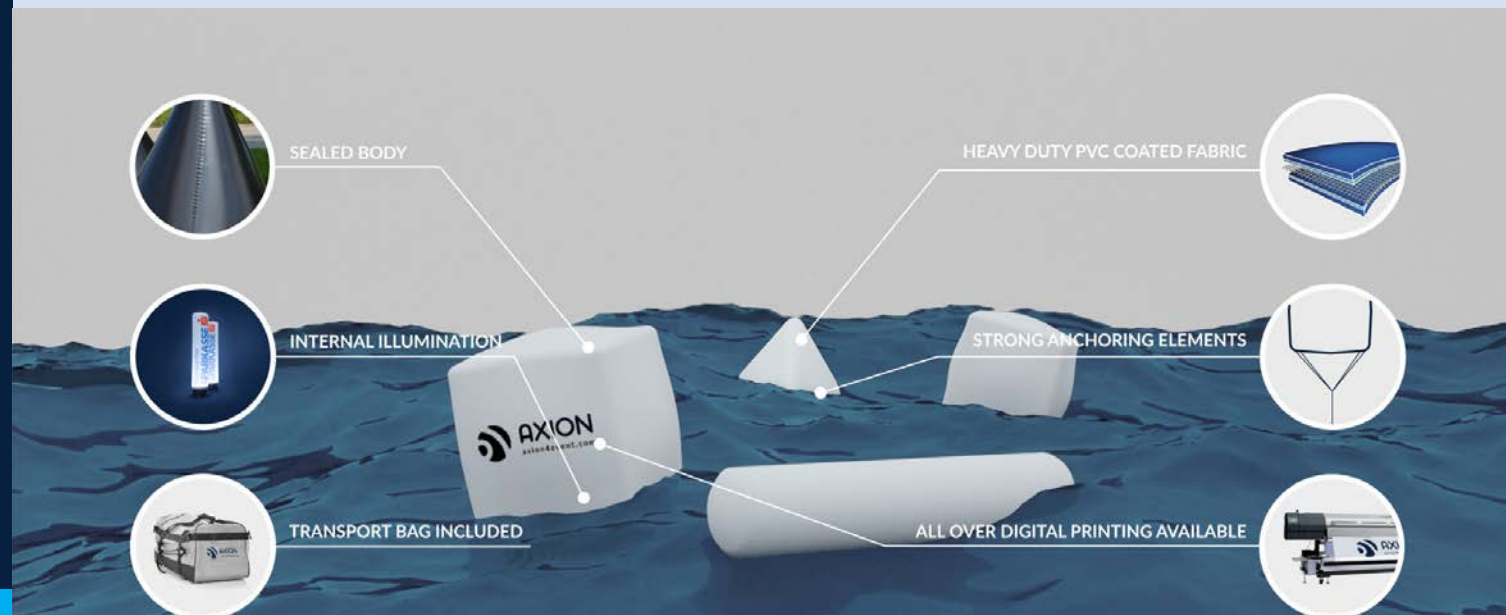



# FURNITURE

inflatable event furniture



## HIGH QUALITY TPU SEALED TUBES

All AXION products use 250mic seamless TPU bladder tubes ended using HF welding technologies. All bladders are accommodated in strong 500D HT polyester, so the whole inflatable structure is rigid, but still flexible in a wide temperature range from cold FIS SKI events to the hot DAKAR RALLY.



## INTERNAL ILLUMINATION

Take the opportunity to use the internal illumination in the Bistro or Bongo inflatable table. Both 230V plug or 12V unplug systems are available in white or RGB version. Thanks to the modern flat LED sources connected to compact click-in Li-Ion batteries, illumination of AXION products is easy to achieve and effective for any night event.



## STABILITY

A ballast plate, a ballast bag or even the combination can be used as an accessory to Bistro or Bongo table. The result is extreme stability. Ballasting of inflatable objects at your events will no longer be an issue.



## INFLATABLE EVENT FURNITURE

AXION Furniture is a great accessory to complete your inflatable event set. Our set of inflatable furniture contains donut seating, puff seating, tables and desks in different shapes and combinations. It is light and easy to transport, but very stable after inflation. The whole installation of your lounge or catering furniture set takes just minutes.



## COLORS WITHOUT LIMITS

We use the newest technologies for dye sublimation printing, automatic cutting and welding, so each object can have different full color design in a photo quality.



## EASY TRANSPORT

Transport of event furniture used to be a nightmare, but it is different with AXION inflatable furniture.



## ACRYLIC GLASS TOP COVER

Acrylic glass top cover - very nice and useful cover especially for showrooms. We don't recommend it for frequent events, because there is risk of scratching or breaking.





# TABLE

bistro & bongo  
simple and  
reliable inflatable  
table for each  
event

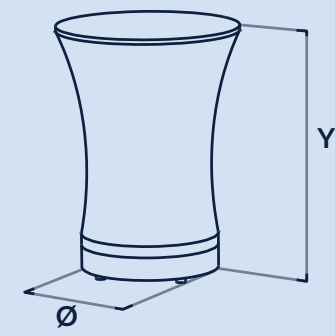

BISTRO TABLE

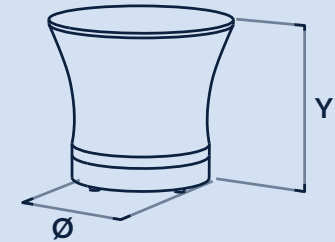

BONGO TABLE

The hour-glass shaped inflatable tables are great to use as solitaire, or to be combined with the Omega inflatable seat. When folded, it is only a disc of 80cm diameter and 12cm height and the weight of the bag is 14kg. In minutes you will get a perfect promotion or catering table. The whole inflatable body is air sealed and no permanent fan is needed after inflation. When the table is well pressurized, it is more stable than any other table on the market. Optional steel ballast plate is available for outdoor events, while internal LED illumination creates a special atmosphere while highlighting your logo printed on the body. AXION Table is a simple and reliable product for any event.

There are two models available – model BISTRO is 110cm high (good for standing catering), model BONGO is 72cm high (good for use in a combination with Omega seat).

	BISTRO	BONGO
Diameter "Ø" (cm)	80	80
Height "Y" (cm)	110	72
Thickness when packed in a bag (cm)	14	12
Weight (w/o shelves) (kg)	13	11
Dye sublimation print all over		possible
Fully serviceable by user		yes

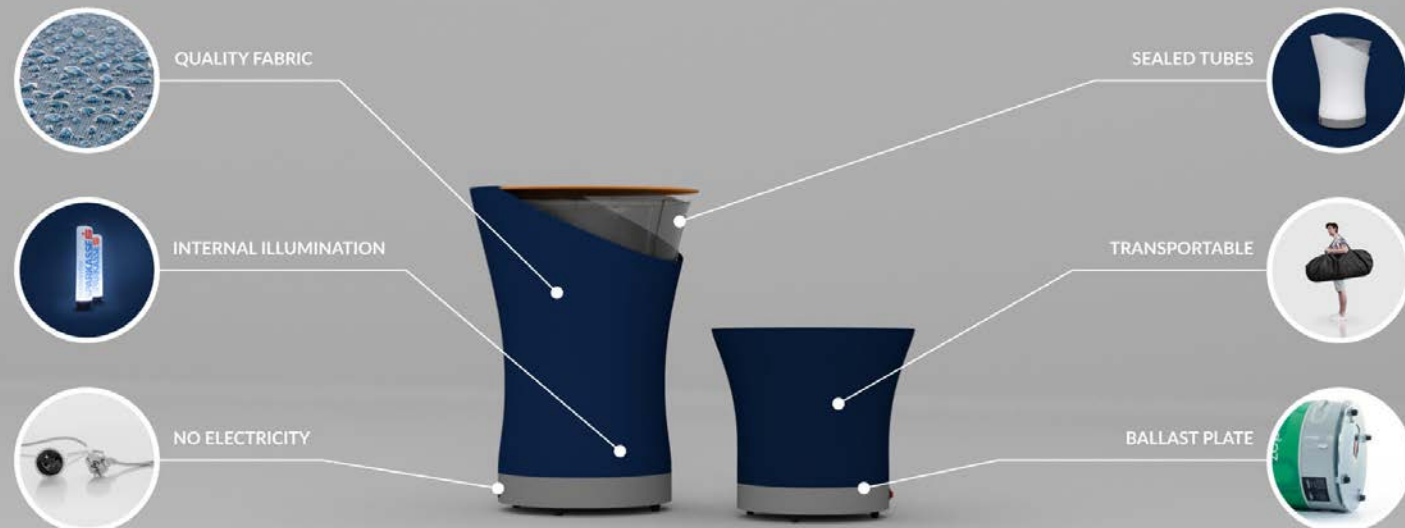



# DESK

inflatable desk  
straight or  
bended shaped

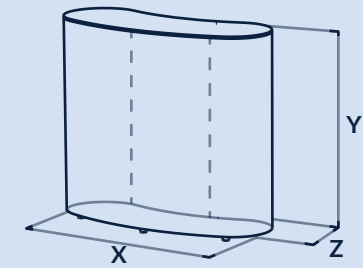

BENDED DESK

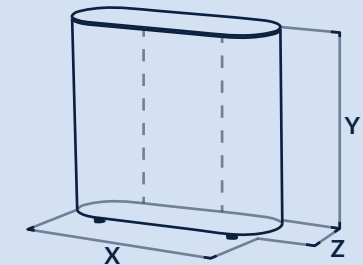

STRAIGHT DESK

AXION Desk is an excellent product for POP / POS campaigns. It comes with an easily transportable bag that is 120x46x12cm in size and weighs only 13kg. One person can inflate the two tubes within 5 minutes resulting in a great desk with a solid top and bottom. Inflatable tubes are air sealed and a permanent fan is not needed after inflation. You have the flexibility to place two shelves in between the inflatable tubes, or add a white or RGB light to illuminate it from the inside. The entire surface area of the desk can be printed in full color dye sublimation upon demand..

There are two models available – BENDED desk or STRAIGHT desk.  
Just choose one that fits your needs

## STRAIGHT DESK

## BENDED DESK

<b>Width "X" (cm)</b>	120	120
<b>Depth "Z"(cm)</b>	40	46
<b>Height "Y" (cm)</b>	105	105
<b>Thickness when packed in a bag (cm)</b>	14	14
<b>Weight (w/o side walls, w. acc.) (kg)</b>	17	18
<b>Dye sublimation print all over</b>		possible
<b>Fully serviceable by user</b>		yes

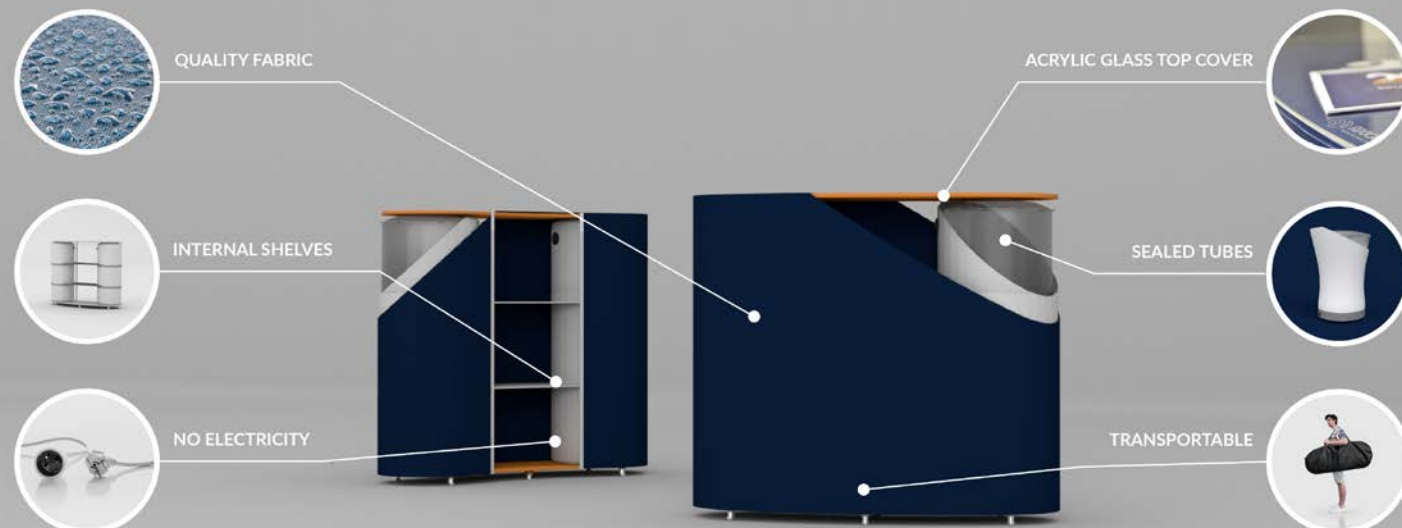



# SEAT

inflatable seat  
for individual or  
groups

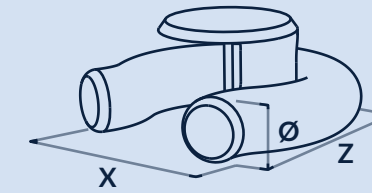

OMEGA SEAT

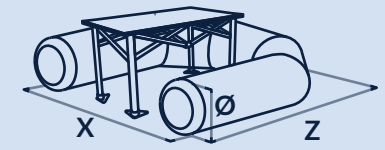

YOU SEAT

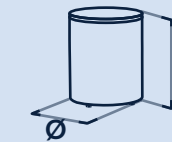

BONGO PUFF

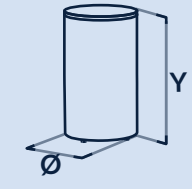

BISTRO PUFF

A standard set of solid table and chairs will not easily fit into a standard sized vehicle. If you are organizing a fair or small event and need even more seating, the AXION Seat can solve this problem easily.

You can choose from different kinds – YOU seat and OMEGA seat or PUFF. YOU or OMEGA are “donut” type seats designed for more seating to be paired with tables. OMEGA fits to the special round fiberglass stackable table or the BONGO table and offers comfortable seating for up to 4 people. YOU seat is designed to fit to the aluminium foldable pop-up table, offering seating for up to 5 people. PUFF is a comfortable individual seat for 1 person, offering a patented combination of air and polystyrol for cushioning in a soft version, or the budget solid version. All types of seats can be printed in full color dye sublimation upon demand.

	OMEGA SEAT	YOU SEAT	BONGO PUFF	BISTRO PUFF
<b>Width "X"(cm)</b>	-	185 - 245	-	-
<b>Depth "Z" (cm)</b>	-	180 - 210	-	-
<b>Diameter "Ø" (cm)</b>	190	-	45	45
<b>Height "Y" (cm)</b>	45	45	50	70
<b>Size of bag (cm)</b>	40 x dia. 20	40 - 50 x dia. 20	15 x dia. 45	15 x dia. 45
<b>Weight (w/o table) (kg)</b>	5	5 - 7	3	4
<b>Dye sublimation print all over</b>			possible	
<b>Fully serviceable by user</b>			yes	

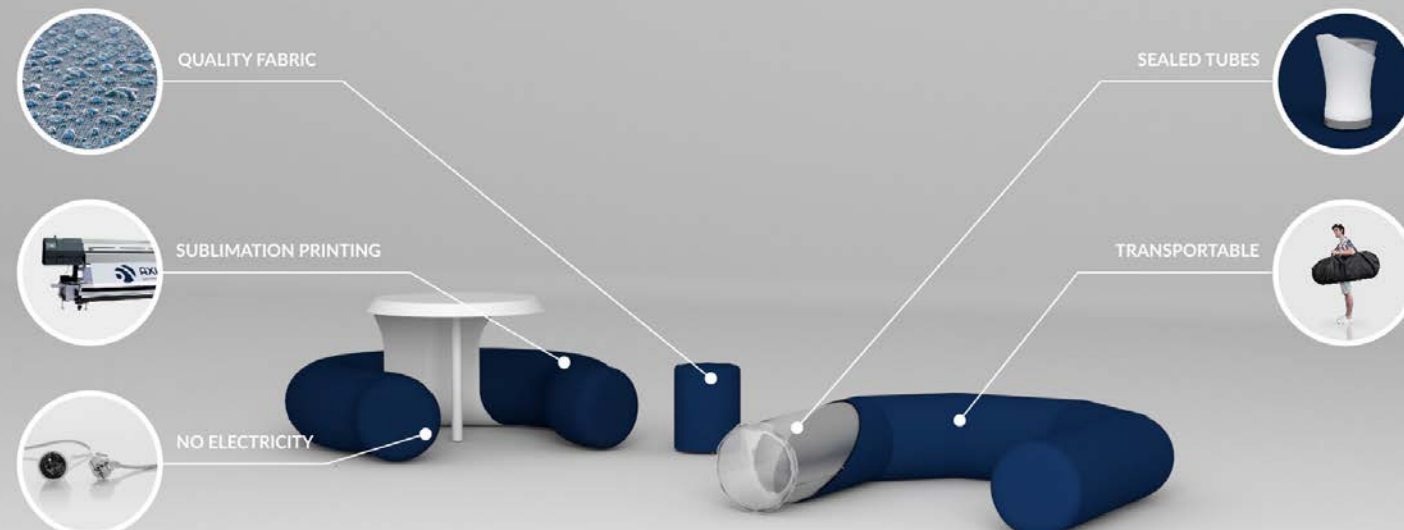



# CHILLOUT

design inflatable furniture for comfort at your event

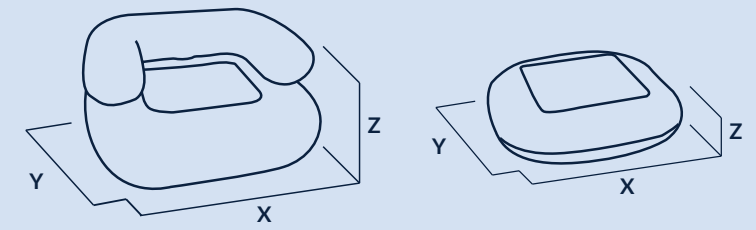

SINGLE CHAIR

TABLE

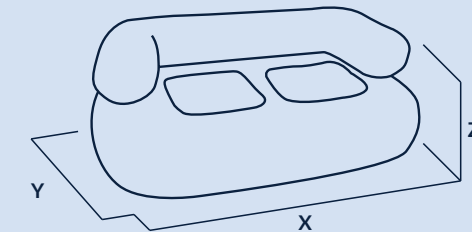

DOUBLE CHAIR

AXION | CHILLOUT is a set of inflatable furniture, containing a single chair, a double chair and a table. Our goal was to make an inflatable furniture, which is really comfortable, so people may relax there for hours. On the other hand we wished to meet budget limits of clients, not willing to spend too much for inflatable furniture. And of course we focused to bring a new design to the market. The result of our development is a great combination of all above.

AXION Chillout is a perfect event solution. Those who would wish to put a branding on it, may combine dye sublimation printed „sock“ on the back support tube, seat mattresses or both. The sock is attached with zippers, so the different one may be used for each event. A table may be equipped with an acrylic glass board, UV printed on the bottom side.

Material used for AXION Chillout is a strong PVC film 0,5mm with „leather look“ embossed surface and reinforced bottom part. Material of chillout furniture is UV stable and easy to be cleaned.

	SINGLE CHAIR	DOUBLE CHAIR	TABLE
Width "X"(cm)	130	180	87
Depth "Z" (cm)	120	120	87
Height "Y" (cm)	72	72	32

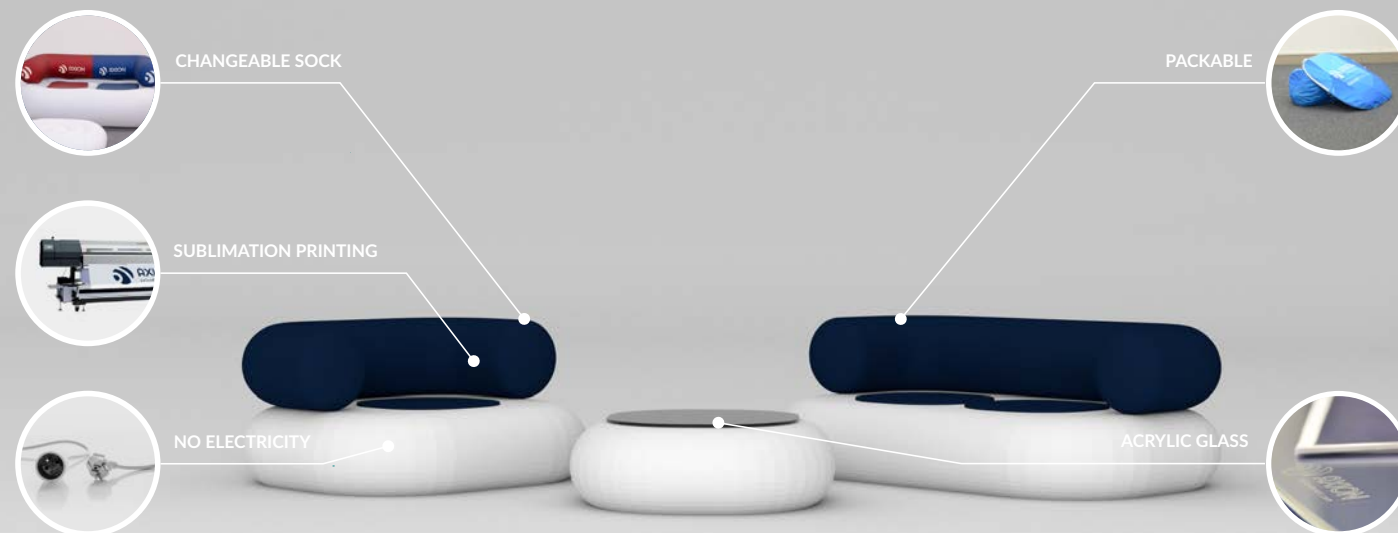





**AXION**  
axion4event.com

e-mail: [info@stretchstructures.com](mailto:info@stretchstructures.com)

web: [stretchstructures.com](http://stretchstructures.com)

Completely developed and produced in E.U.

Quality certificate ISO 9001:2015 and environmental certificate ISO 14001:2015.