



INSPIRING THE WORLD'S KITCHEN



OVER THE RANGE MICROWAVE **COS-30190RM2SS**

INSTALLATION GUIDE

IMPORTANT SAFETY INSTRUCTIONS

Carefully read the following Important information regarding installation safety and maintenance. Keep these instruction for future reference.

COS-30190RM2SS

INSTALL GUIDE

THANK YOU FOR YOUR PURCHASE

Thank you for your purchase. We know that you have many brands and products to choose from and we are honored to know that you have decided to take one of our products into your home and hope that you enjoy it.

COSMO appliances are designed according to the strictest safety and performance standard for the North American market. We follow the most advanced manufacturing philosophy. Each appliance leaves the factory after thorough quality inspection and testing. Our distributors and our service partners are ready to answer any questions you may have regarding how to install, use and care for your products. We hope that this manual will help you learn to use the product in the safest and most effective manner .

If you have any questions or concerns, please contact the dealer from whom you purchased it, or contact our Customer Support at:

1-888-784-3108.

Specifications

Model:	COS-3019ORM2SS
Rated Voltage:	120V~60Hz
Rated Input Power(Microwave):	1550W
Rated Output Power(Microwave):	1000W
Oven Capacity:	53L / 1.9 cu ft
Turntable Diameter:	Ø345mm / 13.6 "
External Dimensions:	29.8" x 16.4" x 15.4"
Net Weight:	Approx. 57.3 lbs

Installation Instructions

CONTENTS

General information

Important Safety Instructions	3
Electrical Requirements	3
Damage - Shipment/Installation	4
Parts Included	4
Tools You Will Need	5
Mounting Space	5

Step-by-step installation guide

Placement of The Mounting Plate	6-8
Removing the Mounting Plate	6
Finding the Wall Studs.....	6
Determining Wall Plate Location	7
Aligning the Wall Plate	8
Installation Types	9-22
Hood Exhaust	10-11

A Outside Top Exhaust	12-15
Attach Mounting Plate to Wall.....	12
Preparation of Top Cabinet.....	13
Adapting Microwave Blower for Outside top Exhaust	13-14
Checking for Proper Damper Operation.....	14
Mount the Microwave Oven	14-15
Adjust the Exhaust Adaptor	15
Connecting Ductwork.....	15

B Outside Back Exhaust.....	16-19
Preparing Rear Wall for Outside Back Exhaust.....	16
Remove Blower Plate.....	16
Attach Mounting Plate to Wall	17
Preparation of Top Cabinet	17

Adapting Microwave Blower
for Outside Back Exhaust.....17-18

Mount the Microwave Oven19

C Recirculating

 Attach Mounting Plate to Wall

 Preparation of Top Cabinet

 Check Blower Plate

 Mount the Microwave Oven

 Installing or Change the
 Charcoal Filter

Before You Use Your Microwave

Template Information.....

IMPORTANT SAFETY INSTRUCTIONS

This product requires a three-prong grounded outlet. The installer must perform a ground continuity check on the power outlet box before beginning the installation to ensure that the outlet box is properly grounded. If not properly grounded, or if the outlet box does not meet electrical requirements noted (under ELECTRICAL REQUIREMENTS), a qualified electrician should be employed to correct any deficiencies.

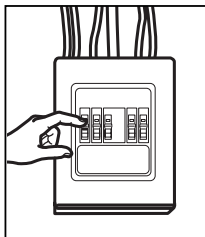

CAUTION: For personal safety, remove house fuse or open circuit breaker before beginning installation to avoid severe or fatal shock injury.

CAUTION: For personal safety, the mounting surface must be capable of supporting the cabinet load, in addition to the added weight of this 63–85 pound (28.5–38.5 kg) product, plus additional oven loads of up to 50 pounds (22.7 kg) or a total weight of 113–135 pounds (51.3–61.2 kg).

CAUTION: For personal safety, this product cannot be installed in cabinet arrangements such as an island or a peninsula. It must be mounted to BOTH a top cabinet AND a wall.

NOTE: For easier installation and personal safety, it is recommended that two people install this product.

IMPORTANT – PLEASE READ CAREFULLY. FOR PERSONAL SAFETY, THIS APPLIANCE MUST BE PROPERLY GROUNDED TO AVOID SEVERE OR FATAL SHOCK.

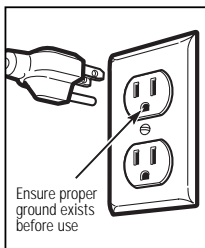

The power cord of this appliance is equipped with a three-prong (grounding) plug which mates with a standard three-prong (grounding) wall receptacle to minimize the possibility of electric shock hazard from this appliance.

You should have the wall receptacle and circuit checked by a qualified electrician to make sure the receptacle is properly grounded.

Where a standard two-prong wall receptacle is encountered, it is very important to have it replaced with a properly grounded three-prong wall receptacle, installed by a qualified electrician.

DO NOT, UNDER ANY CIRCUMSTANCES, CUT, DEFORM OR REMOVE ANY OF THE PRONGS FROM THE POWER CORD. DO NOT USE WITH AN EXTENSION CORD.

ELECTRICAL REQUIREMENTS





Product rating is 120 volts AC, 60 Hertz, 15 amps and 1.6 kilowatts. This product must be connected to a separate and dedicated supply circuit of the proper voltage and frequency. Wire size must conform to the requirements of the National Electrical Code or the prevailing local code for this kilowatt rating. The power supply cord and plug should be brought to a separate and dedicated 20 ampere branch circuit single grounded outlet. The outlet box should be located in the cabinet above the microwave oven. The outlet box and supply circuit should be installed by a qualified electrician and conform to the National Electrical Code or the prevailing local code.

DAMAGE—SHIPMENT/ INSTALLATION

- If the unit is damaged in shipment, return the unit to the store in which it was bought for repair or replacement.
- If the unit is damaged by the customer, repair or replacement is the responsibility of the customer.
- If the unit is damaged by the installer (if other than the customer), repair or replacement must be made by arrangement between customer and installer.

PARTS INCLUDED









HARDWARE PACKET

PART		QUANTITY
	Wood Screws (1/4" x 2")	2
	Toggle Bolts (and wing nuts) (3/8" x 3")	2
	Self-Aligning Machine Screws (1/4"-28 x 3 1/4")	3
	Nylon Grommet (for metal cabinets)	1

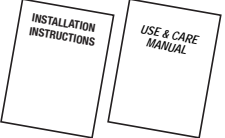
You will find the installation hardware contained in a packet with the unit. Check to make sure you have all these parts.

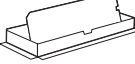
NOTE: Some extra parts are included.

PARTS INCLUDED (CONT.) ADDITIONAL PARTS

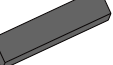
PART		QUANTITY
	Top Cabinet Template	1
	Rear Wall Template	1
	Installation Instructions	1
	Use & Care Manual	1
	Separately Packed Grease Filters	2
	Exhaust adaptor	1
	Glass Tray	1
	Turntable Ring	1
For some models 	Convection wire rack	1
For some models 	Shelf	1
For some models 	PureAir® Microwave Filter	1

Installation Instructions

TOOLS YOU WILL NEED

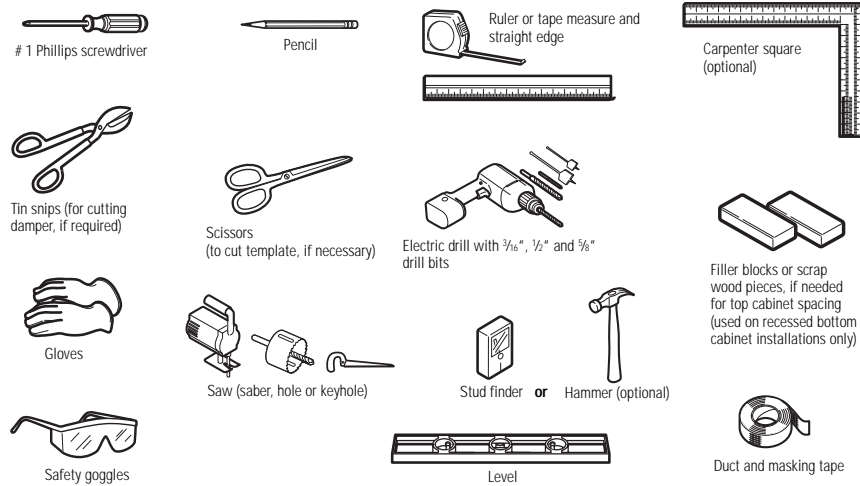

MOUNTING SPACE

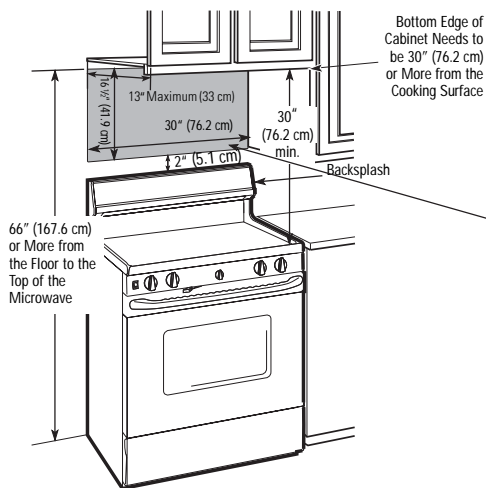

NOTES:

- The space between the cabinets must be 30" (76.2 cm) wide and free of obstructions.
- If you are going to vent your microwave oven to the outside, see Hood Exhaust Section for exhaust duct preparation.
- When installing the microwave oven beneath smooth, flat cabinets, be careful to follow the instructions on the top cabinet template for power cord clearance.
- As a guide to installation, see page 25 for Mounting Template Information.
- If the cabinet depth including the cabinet doors is more than 13" then the unit must be spaced out from wall using adequate materials supporting 150 lbs to allow proper top vent air exhaust/intake.

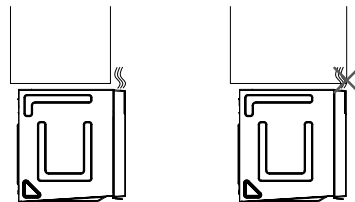

Installation Instructions

1 PLACEMENT OF THE MOUNTING PLATE

A. REMOVING THE MICROWAVE OVEN FROM THE CARTON/ REMOVING THE MOUNTING PLATE

- 1 Remove the top cover board, installation instructions, use and care, exhaust adapter, turntable ring, shelf, filters, glass tray and the small hardware bag. Do not remove the Styrofoam protecting the front of the oven.

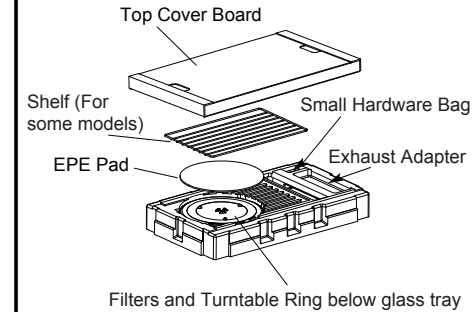

- 2 Fold back all 4 carton flaps fully against carton sides. Then carefully roll the oven and carton over onto the top side. The oven should be resting in the Styrofoam.

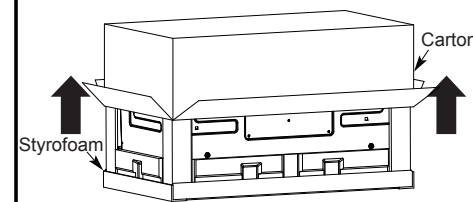

- 3 Pull the carton up and off the oven.

- 4 Cut the middle of the outer protective plastic bag to remove the mounting plate

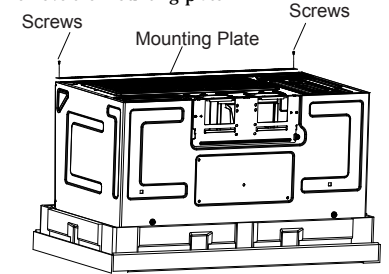

- 5 Remove the screws from each end of the mounting plate. This plate will be used as the rear wall template and for mounting. Reinstall the screws into the holes where they were removed.

B. FINDING THE WALL STUDS

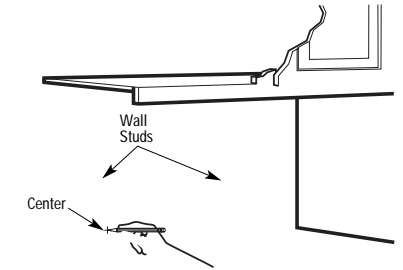

- 1 Find the studs, using one of the following methods:
 - A. Stud finder – a magnetic device which locates nails.
 - B. Use a hammer to tap lightly across the mounting surface to find a solid sound. This will indicate a stud location.
- 2 After locating the stud(s), find the center by probing the wall with a small nail to find the edges of the stud. Then place a mark halfway between the edges. The center of any adjacent studs should be 16" (40.6 cm) or 24" (61 cm) from this mark.
- 3 Draw a line down the center of the studs.

THE MICROWAVE MUST BE CONNECTED TO AT LEAST ONE WALL STUD.

C. DETERMINING WALL PLATE LOCATION UNDER YOUR CABINET

Plate position-beneath flat bottom cabinet

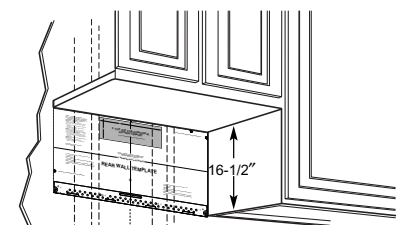

Draw a vertical line on the wall at the center of the 30" wide space. Tape the Rear Wall Template onto the wall matching the centerline and touching the bottom of the cabinet.

Plate position-beneath framed recessed cabinet bottom

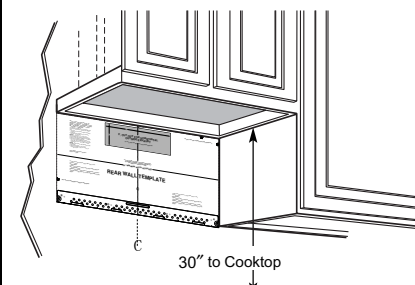

Draw a vertical line on the wall at the center of the 30" space. Tape the Rear Wall Template onto the wall matching the centerline and touching the bottom cabinet frame.

Plate position-beneath recessed bottom cabinet with front overhang

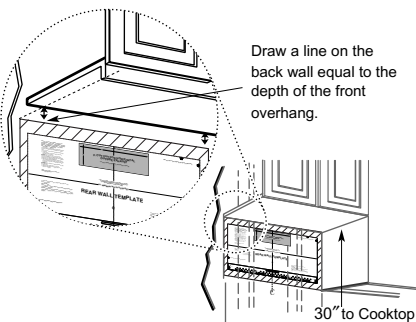

Draw a line on the back wall equal to the depth of the front overhang.

Your cabinets may have decorative trim that interferes with the microwave installation. Remove the decorative trim to install the microwave properly and to make it level.

THE MICROWAVE MUST BE LEVEL.

Use a level to make sure the cabinet bottom is level. If the cabinets have a front overhang only, with no back or side frame, install the mounting plate down the same distance as the front overhang depth. This will keep the microwave level.

- 1 Measure the inside depth of the front overhang.
- 2 Draw a horizontal line on the back wall an equal distance below the cabinet bottom as the inside depth of the front overhang.
- 3 For this type of installation with front overhang only, align the mounting tabs with this horizontal line, not touching the cabinet bottom as described in Step D.

D. ALIGNING THE WALL PLATE

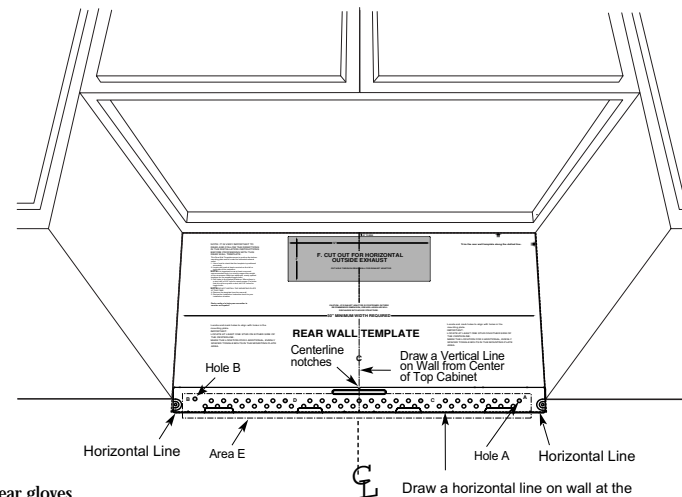

CAUTION: Wear gloves to avoid cutting fingers on sharp edges.

Draw a horizontal line on wall at the bottom of "Rear Wall Template".

- 1 Draw a vertical line on the wall at the center of the 30" wide space.
- 2 Draw a horizontal line on the wall at the bottom of "Rear Wall Template".
- 3 Find a wall stud in area "E" of mounting plate. Refer to section 1B. Finding the wall studs.
- 4 For attaching the mounting plate into stud drill a 3/16" hole into wood stud. Drill a 5/8" hole for toggle bolt in 1 other location (Hole A or Hole B)

NOTE: Holes A and B are inside area E. If neither of Holes A and B are not in a stud, find a stud somewhere in area E and draw a circle to line up with the stud. It is important to have **at least one wood screw** mounted **firmly in a stud** to support the weight of the microwave. **Set the mounting plate aside.**

NOTE: DO NOT MOUNT THE PLATE AT THIS TIME.

Installation Instructions

2 INSTALLATION TYPES

This microwave oven is designed for adaptation to the following three types of ventilation:

- A. Outside Top Exhaust (Vertical Duct)
- B. Outside Back Exhaust (Horizontal Duct)
- C. Recirculating (Non-Vented Ductless)

(Choose A, B or C)

NOTE: This microwave is shipped assembled for Recirculating. Select the type of ventilation required for your installation and proceed to that section.

A OUTSIDE TOP EXHAUST (VERTICAL DUCT)

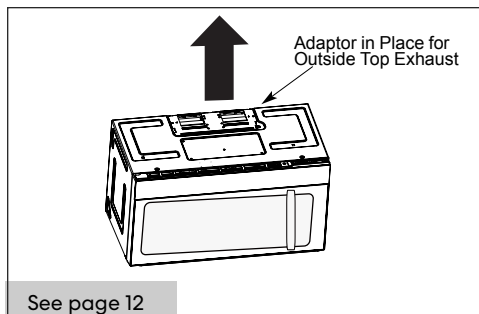

B OUTSIDE BACK EXHAUST (HORIZONTAL DUCT)

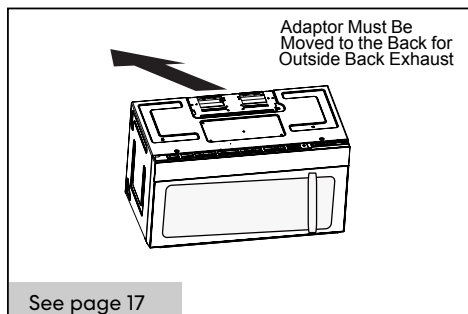

C RECIRCULATING (NON-VENTED DUCTLESS)

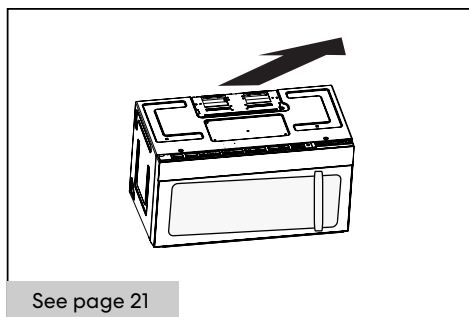

NOTE: Read the next two pages only if you plan to vent your exhaust to the outside. If you plan to recirculate the air back into the room, proceed to page 20.

Installation Instructions

INSTALLATION INSTRUCTIONS FOR EXTERNAL EXHAUST DUCTING

NOTE: If you need to install ducts, note that the total duct length of 3/4" x 10" (8.2 x 25.4 cm) rectangular or 5" (12.7 cm) diameter / 6" (15.2 cm) diameter round duct **should not exceed 120 equivalent feet (36.5 m).**

Outside ventilation requires an EXTERNAL EXHAUST DUCT. Read the following carefully.

NOTE: It is important that venting be installed using the most direct route and with as few elbows as possible. This ensures clear venting of exhaust and helps prevent blockages. **Also, make sure dampers swing freely and nothing is blocking the ducts.**

Exhaust connection:

The exhaust adaptor has been designed to mate with a standard 3/4" x 10" (8.2 x 25.4 cm) rectangular duct.

If a round duct is required, a rectangular-to-round transition adaptor must be used. **A 5" (12.7cm) / 6" (15.2cm) diameter duct is acceptable to use.**

Maximum duct length:

For satisfactory air movement, the total duct length of 3/4" x 10" (8.2 x 25.4 cm) rectangular or 5" (12.7 cm) diameter / 6" (15.2 cm) diameter round duct **should not exceed 120 equivalent feet (36.5 m).**

Elbows, transitions, wall and roof caps, etc., present additional resistance to airflow and are equivalent to a section of straight duct which is longer than their actual physical size. When calculating the total duct length, add the equivalent lengths of all transitions and adaptors plus the length of all straight duct sections. The chart below shows you how to calculate total equivalent ductwork length using the approximate feet of equivalent length of some typical ducts.

DUCT PIECES		EQUIVALENT LENGTH	x	NUMBER USED	=	EQUIVALENT LENGTH
	Rectangular-to-Round Transition Adaptor*	5 Ft. (1.5 m)	x	()	=	Ft. or m
	Wall Cap	40 Ft. (12.2 m)	x	()	=	Ft. or m
	90° Elbow	10 Ft. (3 m)	x	()	=	Ft. or m
	45° Elbow	5 Ft. (1.5 m)	x	()	=	Ft. or m
	90° Elbow	25 Ft. (7.6 m)	x	()	=	Ft. or m
	45° Elbow	5 Ft. (1.5 m)	x	()	=	Ft. or m
	Roof Cap	24 Ft. (7.3 m)	x	()	=	Ft. or m
	Straight Duct 6" (15.2 cm) Round or 3/4" x 10" (8.2 x 25.4 cm Rectangular)	1 Ft. (0.3 m)	x	()	=	Ft. or m
Total Ductwork					=	Ft. or m

* **IMPORTANT:** If a rectangular-to-round transition adaptor is used, the bottom corners of the damper will have to be cut to fit, using the tin snips, in order to allow free movement of the damper.

Equivalent lengths of duct pieces are based on actual tests and reflect requirements for good venting performance with any vent hood.

EXTERNAL EXHAUST DUCTING

OUTSIDE TOP EXHAUST (EXAMPLE ONLY)

The following chart describes an example of one possible ductwork installation.

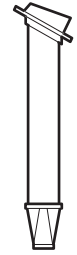

DUCT PIECES		EQUIVALENT LENGTH	x	NUMBER USED	=	EQUIVALENT LENGTH	
	Roof Cap	24 Ft. (7.3 m)	x	(1)	=	24 Ft. (7.3 m)	
	12 Ft. (3.6 m) Straight Duct (6"/15.2 cm Round)	12 Ft. (3.6 m)	x	(1)	=	12 Ft. (3.6 m)	
	Rectangular-to-Round Transition Adaptor*	5 Ft. (1.5 m)	x	(1)	=	5 Ft. (1.5 m)	
Equivalent lengths of duct pieces are based on actual tests and reflect requirements for good venting performance with any vent hood.						Total Length =	41 Ft. (12.4 m)

* **IMPORTANT:** If a rectangular-to-round transition adaptor is used, the bottom corners of the damper will have to be cut to fit, using the tin snips, in order to allow free movement of the damper.

OUTSIDE BACK EXHAUST (EXAMPLE ONLY)

The following chart describes an example of one possible ductwork installation.



DUCT PIECES		EQUIVALENT LENGTH*	x	NUMBER USED	=	EQUIVALENT LENGTH	
	Wall Cap	40 Ft. (12.2 m)	x	(1)	=	40 Ft. (12.2 m)	
	3 Ft. Straight Duct (3/4" x 10"/8.2 x 25.4 cm Rectangular)	3 Ft. (0.9 m)	x	(1)	=	3 Ft. (0.9 m)	
	90° Elbow	10 Ft. (3 m)	x	(2)	=	20 Ft. (6 m)	
Equivalent lengths of duct pieces are based on actual tests and reflect requirements for good venting performance with any vent hood.						Total Length =	63 Ft. (19.1 m)

NOTE: For back exhaust, care should be taken to align exhaust with space between studs, or wall should be prepared at the time it is constructed by leaving enough space between the wall studs to accommodate exhaust.

Installation Instructions

A OUTSIDE TOP EXHAUST

(Vertical Duct)

INSTALLATION OVERVIEW

- A1. Attach Mounting Plate to wall
- A2. Prepare Top Cabinet
- A3. Configure Microwave Blower for Outside / Top Exhaust
- A4. Check Damper Operation
- A5. Mount Microwave Oven
- A6. Adjust Exhaust Adapter
- A7. Connect Duct-work

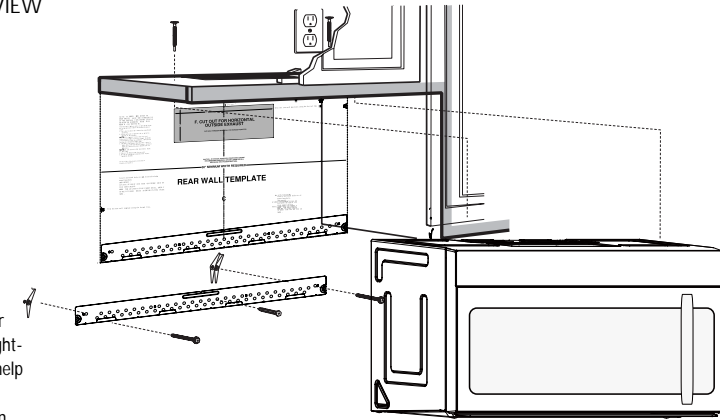

IMPORTANT NOTE

- Make sure the screws for the Blower Motor and Blower Plate are securely tightened when they are installed. This will help to prevent excessive vibration.
- Make sure the Motor wiring has been properly routed and secured, and that the wires are not pinched.

A1. ATTACH THE MOUNTING PLATE TO THE WALL

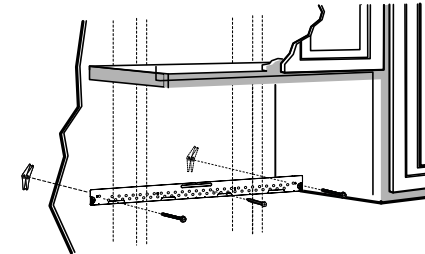

To use toggle bolts:

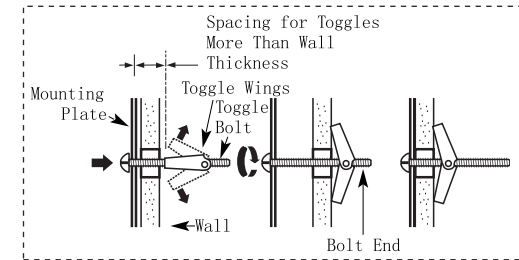

[3] Place the mounting plate against the wall and insert the toggle wings into the holes in the wall to mount the plate.

NOTE: Before tightening toggle bolts and wood screw, make sure the bottom of the mounting plate touches the bottom of the cabinet when pushed flush against the wall and the plate is properly centered under the cabinet.

CAUTION: Be careful and avoid pinching fingers between the back of the mounting plate and the wall.

[4] Tighten all bolts. Pull the plate away from the wall to help tighten the bolts.

- Attach the plate to the wall using toggle bolts.
 - At least one wood screw must be used to attach the plate to a wall stud.
- [1] Remove the toggle wings from the bolts
 - [2] Insert the bolts into the mounting plate through the holes designated to go into drywall and reattach the toggle wings to 3/4" (19mm) onto each bolt.

A2. USE TOP CABINET TEMPLATE FOR PREPARATION OF TOP CABINET

You need to drill holes for the top support screws, a hole large enough for the power cord to fit through, and a cutout large enough for the exhaust adaptor.

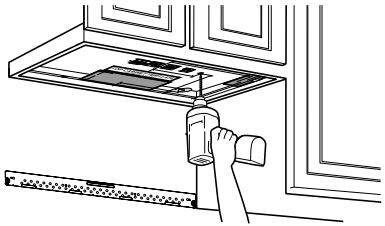

- Read the instructions on the TOP CABINET TEMPLATE.
- Tape it underneath the top cabinet.
- Drill the holes, following the instructions on the TOP CABINET TEMPLATE.

CAUTION: Wear safety goggles when drilling holes in the cabinet bottom.

A3. ADAPTING MICROWAVE BLOWER FOR OUTSIDE TOP EXHAUST

- 1 Place the microwave in its upright position, with the top of the unit facing up.

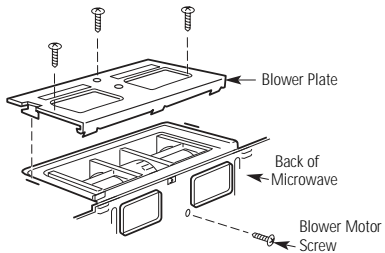

Remove the screw that holds the blower plate to the microwave. Remove and save the screw holding the blower motor to the microwave.

- 2 Carefully pull out the blower unit. The wires will extend far enough to allow you to adjust the blower unit.

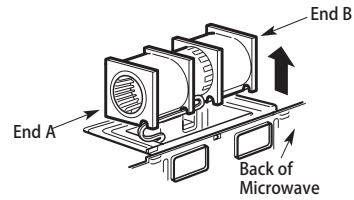

- 3 Roll the blower unit 90° so that fan blade openings are facing out the top of the microwave.

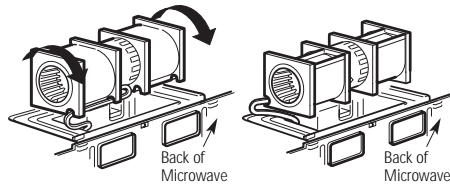

- 4 Place the blower unit back into the opening.

AFTER: Fan Blade Openings Facing Top

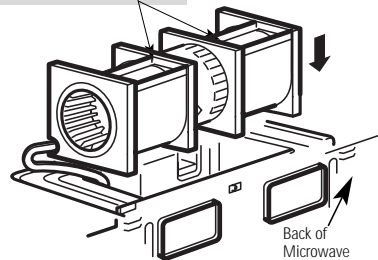

CAUTION: Do not pull or stretch the blower unit wiring. Make sure the wires are not pinched, and that they are properly secured.

A3. ADAPTING MICROWAVE BLOWER FOR OUTSIDE TOP EXHAUST

- 5 Secure blower unit to microwave with the screw removed in Step 1. Make sure the screw is tight.
- 6 Replace blower plate with the screw removed in Step 1. Make sure the screw is tight.

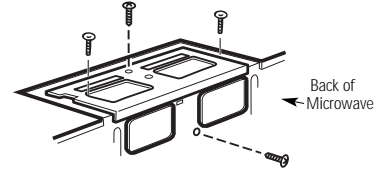

- 7 Attach the exhaust adaptor to the top of the blower plate by sliding it into the guides of the blower plate.

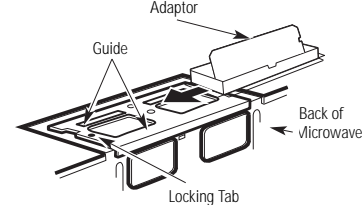

Push in securely until it is in the locking tabs. Take care to assure that the damper hinge is installed so that the damper swings freely.

A4. CHECK FOR PROPER DAMPER OPERATION

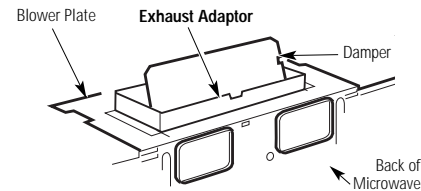

- Make sure tape securing damper is removed and damper pivots easily before mounting microwave.
- You will need to make adjustments to assure proper alignment with your house exhaust duct after the microwave is installed.

A5. MOUNT THE MICROWAVE OVEN

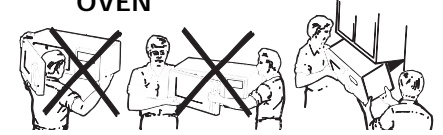

FOR EASIER INSTALLATION AND PERSONAL SAFETY, WE RECOMMEND THAT **TWO PEOPLE** INSTALL THIS MICROWAVE OVEN. **IMPORTANT: Do not grip or use the handle or heat shield during installation. Do not remove the cardboard spacers between the heat shield and door.**

NOTE: If your cabinet is metal, use the nylon grommet around the power cord hole to prevent cutting of the cord.

NOTE: We recommend using filler blocks if the cabinet front hangs below the cabinet bottom shelf.

IMPORTANT: If filler blocks are not used, case damage may occur from overtightening screws.

NOTE: When mounting the microwave oven, thread power cord through hole in bottom of top cabinet. Keep it tight throughout Steps 1-3. Do not pinch cord or lift oven by pulling cord.

- 1 Lift microwave, tilt it forward, and hook slots at back bottom edge onto four lower tabs of mounting plate.

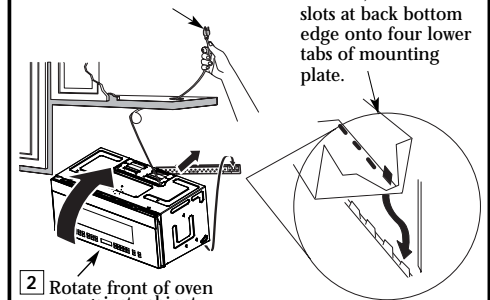

- 2 Rotate front of oven up against cabinet bottom.
- 3 Insert a self-aligning screw through top center cabinet hole. Temporarily secure the oven by turning the screw at least **two full turns** after the threads have engaged. (It will be completely tightened later.) **Be sure to keep power cord tight. Be careful not to pinch the cord, especially when mounting flush to bottom of cabinet.**

A5. MOUNT THE MICROWAVE (cont.)

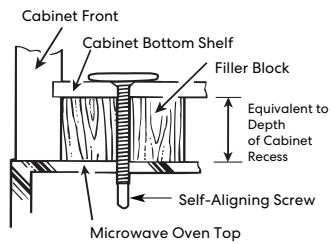

4 Attach the microwave oven to the top cabinet.

5 Insert 2 self-aligning screws through outer top cabinet holes. Turn two full turns on each screw.

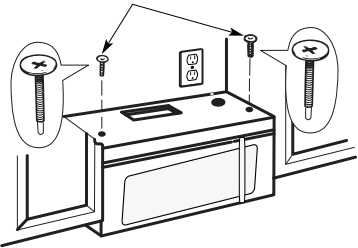

7 Tighten the outer two screws to the top of the microwave oven. (While tightening screws, hold the microwave oven in place against the wall and the top cabinet.)

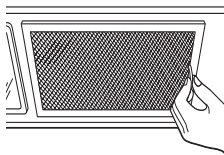

8 Install grease filters. See the Use & Care Guide packed with the microwave.

A6. ADJUST THE EXHAUST ADAPTOR

Open the top cabinet and adjust the exhaust adaptor to connect to the house duct.

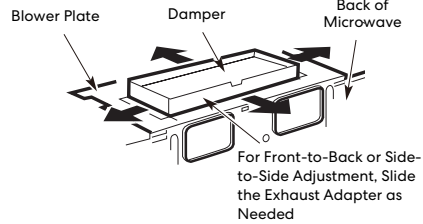

A7. CONNECTING DUCTWORK

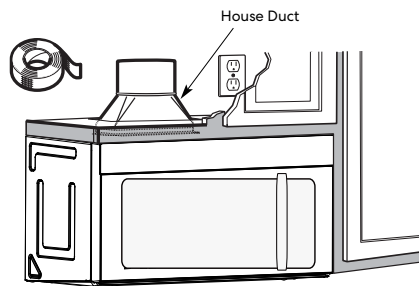

- 1 Extend the house duct down to connect to the exhaust adaptor.
- 2 Seal exhaust duct joints using furnace duct tape for high temperature applications

B OUTSIDE BACK EXHAUST (Horizontal Duct)

INSTALLATION OVERVIEW

- B1. Prepare Rear Wall
- B2. Remove Blower Plate
- B3. Attach Mounting Plate to Wall
- B4. Prepare Top Cabinet
- B5. Adjust Blower
- B6. Mount the Microwave Oven

IMPORTANT NOTES

- Make sure the screws for the blower motor and blower plate are securely tightened when they are reinstalled. This will help prevent excessive vibration.
- Make sure the motor wiring has been properly routed and secured and that the wires are not pinched.

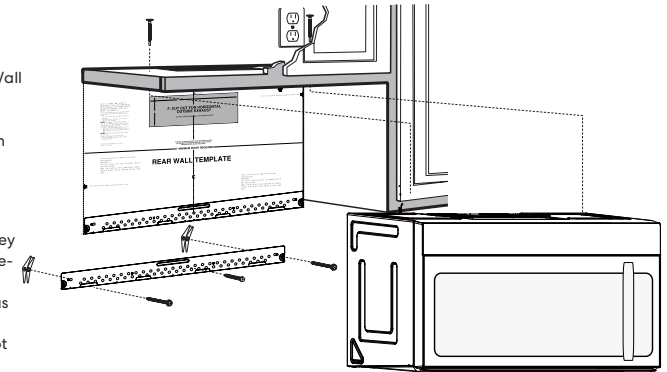

B1. PREPARING THE REAR WALL FOR OUTSIDE BACK EXHAUST

You need to cut an opening in the rear wall for outside exhaust.

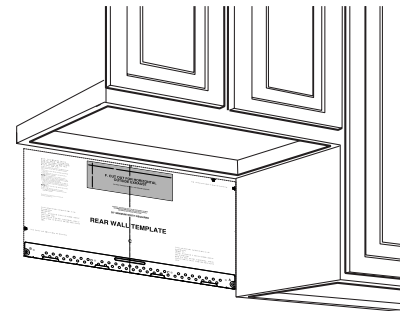

- Read the instructions on the REAR WALL TEMPLATE. Tape it to the rear wall.
- Cut the opening, following the instructions of the REAR WALL TEMPLATE.

B2. REMOVE BLOWER PLATE

Remove and save the screw that holds the blower plate to the microwave. Lift off the blower plate.

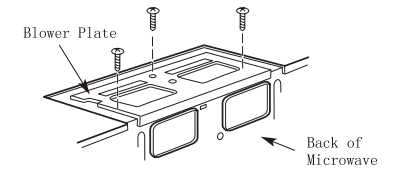

B3. ATTACH THE MOUNTING PLATE TO THE WALL

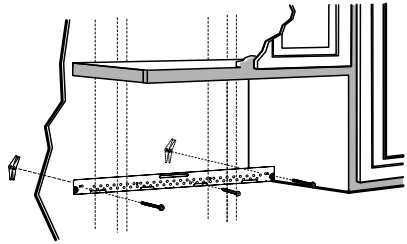

Attach the plate to the wall using toggle bolts. At least one wood screw must be used to attach the plate to a wall stud.

- 1 Remove the toggle wings from the bolts.
- 2 Insert the bolts into the mounting plate through the holes designated to go into drywall and reattach the toggle wings to 3/4" (19 mm) onto each bolt.

To use toggle bolts:

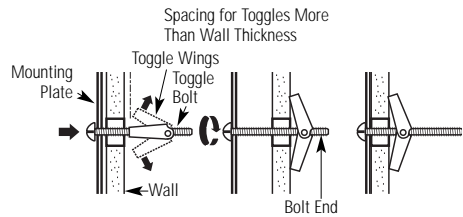

- 3 Place the mounting plate against the wall and insert the toggle wings into the holes in the wall to mount the plate.

NOTE: Before tightening toggle bolts and wood screw, make sure the bottom of the mounting plate touch the bottom of the cabinet when pushed flush against the wall and that the plate is properly centered under the cabinet.

CAUTION: Be careful to avoid pinching fingers between the back of the mounting plate and the wall.

- 4 Tighten all bolts. Pull the plate away from the wall to help tighten the bolts.

B4. USE TOP CABINET TEMPLATE FOR PREPARATION OF TOP CABINET

You need to drill holes for the top support screws and a hole large enough for the power cord to fit through.

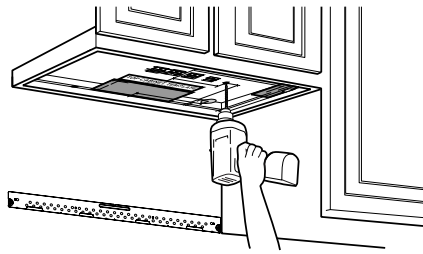

- Read the instructions on the TOP CABINET TEMPLATE.
- Tape it underneath the top cabinet.
- Drill the holes, following the instructions on the TOP CABINET TEMPLATE.

CAUTION: Wear safety goggles when drilling holes in the cabinet bottom.

B5. ADAPTING MICROWAVE BLOWER FOR OUTSIDE BACK EXHAUST

- 1 Remove and save screw that holds blower motor to microwave.

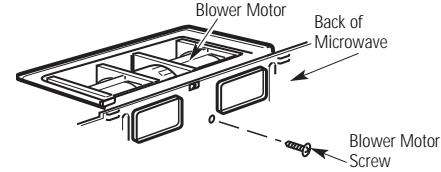

- 2 Carefully pull out the blower unit. The wires will extend far enough to allow you to adjust the blower unit.

Before: Fan Blade Openings Facing Forward

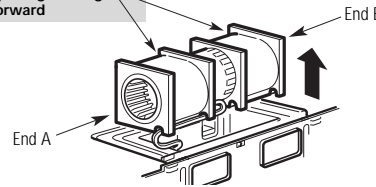

- 3 Roll the blower unit 90°

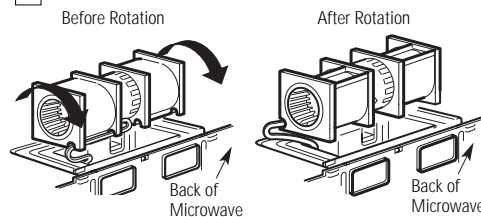

B5. ADAPTING MICROWAVE BLOWER FOR OUTSIDE BACK EXHAUST (cont.)

- 4 Rotate blower unit counterclockwise 180°.

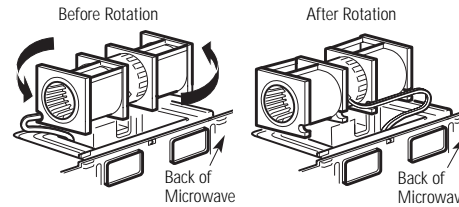

- 5 Gently remove the wires from the grooves. Reroute the wires through grooves on other side of the blower unit.

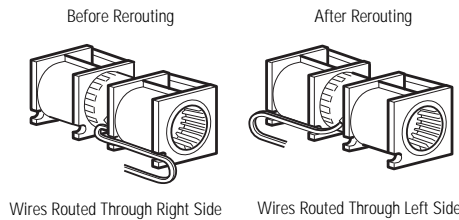

- 6 Rotate the blower unit 90° so that fan blade openings are facing out the back of the microwave.

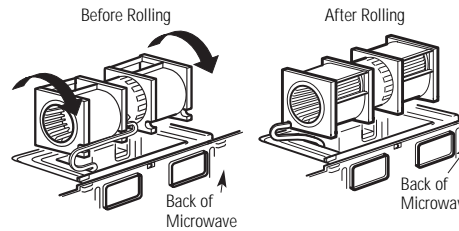

- 7 Remove the knockout plates in the back of the unit with snips. (for some models)

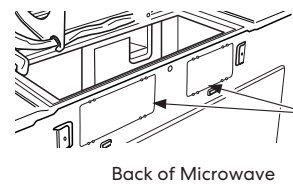

Knockout Plates: Snip all 4 webs on each knockout panel and remove the metal knockouts for rear airflow. Please take care to remove any sharp edges created from removing the knockout plates.

- 8 Place the blower unit back into the opening.

AFTER: Fan Blade Openings Facing Back

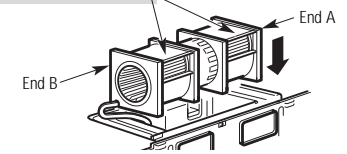

CAUTION: Do not pull or stretch the blower unit wiring. Make sure the wires are not pinched, and that they are properly secured.
NOTE: The blower unit exhaust openings should match exhaust openings on rear of microwave oven.

- 9 Secure the blower unit to the microwave with the original screw.

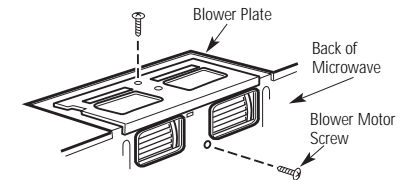

- 10 Replace the blower plate in the same position as before with the screw. Make sure the screw is tight.

- 11 Attach the exhaust adaptor to the rear of the oven by sliding it into the guides at the top center of the back of the oven.

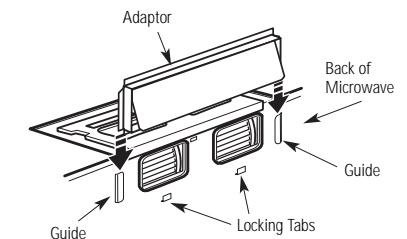

Push in securely until it is in the lower locking tabs. Take care to assure that the damper hinge is installed so that it is at the top and that the damper swings freely.

B. Outside Back Exhaust (Horizontal Duct)

B6. MOUNT THE MICROWAVE OVEN

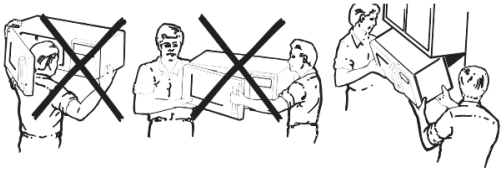

FOR EASIER INSTALLATION AND PERSONAL SAFETY, WE RECOMMEND THAT TWO PEOPLE INSTALL THIS MICROWAVE OVEN.

IMPORTANT: Do not grip or use the handle or heat shield during installation. Do not remove the cardboard spacers between the heat shield and door.

NOTE: If your cabinet is metal, use the nylon grommet around the power cord hole to prevent cutting of the cord.

NOTE: We recommend using filler blocks of the cabinet front hangs below the cabinet bottom shelf.

IMPORTANT: If filler blocks are not used, case damage may occur from over tightening screws.

NOTE: When mounting the microwave oven, thread power cord through hole in bottom of top cabinet. Keep it tight throughout steps 1-3. Do not pinch cord or lift oven by pulling cord.

- 1 Lift microwave, tilt it forward, and hook slots at back bottom edge onto four lower tabs of mounting plate.

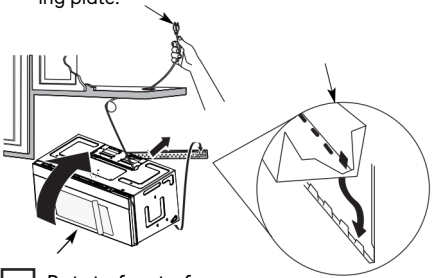

- 2 Rotate front of oven up against bottom.

- 3 Insert self-aligning screw through top center cabinet hole. Temporarily secure the oven by turning the screw at least two full turns after the threads have engaged (it will be completely tightened later). Be sure to keep the power cord tight. Be careful not to pinch the cord, especially when mounting flush to bottom of cabinet.

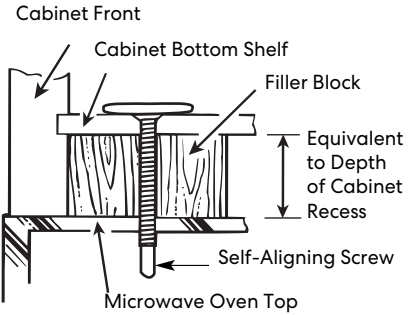

- 4 Attach the microwave oven to the top cabinet.

- 5 Insert 2 self-aligning screws through outer top cabinet holes. Turn two full turns on each screw.

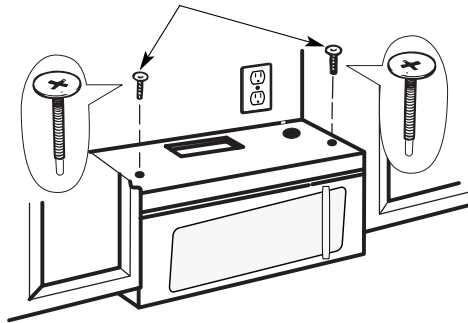

- 6 Tighten the outer two screws to the top of the microwave oven. (While tightening screws, hold the microwave oven in place against the wall and the top cabinet.)

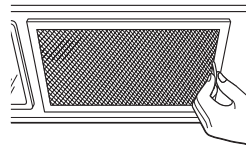

- 7 Install grease filters. See the Use & Care Guide that came with the microwave for more information.

C RECIRCULATING (non vented ductless)

INSTALLATION OVERVIEW

- C1. Attach Mounting Plate to Wall
- C2. Prepare Top Cabinet
- C3. Check Blower Plate
- C4. Mount the Microwave Oven
- C5. Install or change Charcoal Filter

IMPORTANT NOTES

- Make sure the screws for the blower motor and blower plate are securely tightened when they are reinstalled. This will help prevent excessive vibration.
- Make sure the motor wiring has been properly routed and secured and that the wires are not pinched.

- C1 ATTACH THE MOUNTING PLATE TO THE WALL

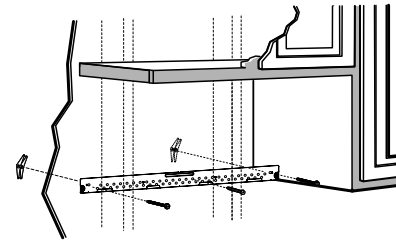

Attach the plate to the wall using toggle bolts. At least one wood screw must be used to attach the plate to a wall stud.

If the cabinet depth including the cabinet doors is more than 13", then the unit must be spaced out from wall using adequate materials supporting 150 lbs to allow proper top vent air exhaust/intake.

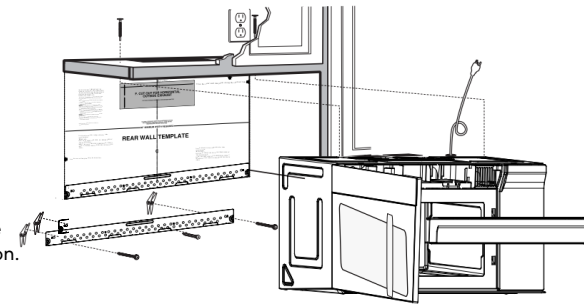
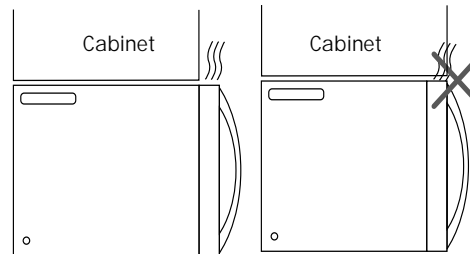

- 1 Remove the toggle wings from the bolts.
- 2 Insert the bolts into the mounting plate through the holes designated to go into drywall and reattach the toggle wings 3/4" to (19mm) onto each bolt.

To use toggle bolts:

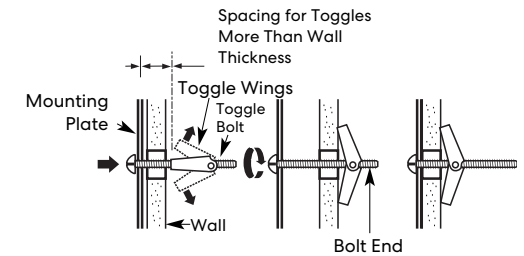

- 3 Place the mounting plate against the wall and insert the toggle wings into the holes in the wall to mount the plate.

NOTE: Before tightening toggle bolts and wood screw, make sure the bottom of the mounting plate touch the bottom of the cabinet when pushed flush against the wall and that the plate is properly centered under the cabinet.

CAUTION: Be careful to avoid pinching fingers between the back of the mounting plate and the wall.

- 4 Tighten all bolts. Pull the plate away from the wall to help tighten the bolts.

C. Recirculating (Non Vented Ductless)

C2. USE TOP CABINET TEMPLATE FOR PREPARATION OF TOP CABINET

You need to drill holes for the top support screws and a hole large enough for the power cord to fit through.

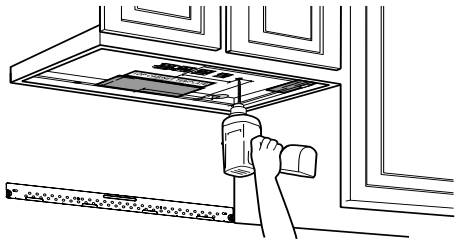

- Read the instructions on the TOP CABINET TEMPLATE.
- Tape it underneath the top cabinet.

NOTE: Adjust top template accordingly if the microwave is being spaced out from the wall due to cabinet depth (including cabinet doors) of more than 13".

Drill the holes following instructions on the TOP CABINET TEMPLATE.

CAUTION: Wear safety goggles when drilling holes in the cabinet bottom.

C3. CHECK BLOWER PLATE

Blower Plate

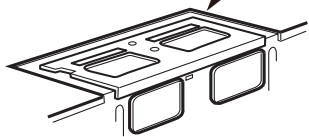

Place the microwave in its upright position, with the top of the unit facing up. Check to see that the blower plate is correctly installed on the unit.

C4. MOUNT THE MICROWAVE OVEN



FOR EASIER INSTALLATION AND PERSONAL SAFETY, WE RECOMMEND THAT TWO PEOPLE INSTALL THIS MICROWAVE OVEN.

IMPORTANT: Do not grip or use the handle or heat shield during installation. Do not remove the cardboard spacers between the heat shield and door.

NOTE: If your cabinet is metal, use the nylon grommet around the power cord hole to prevent cutting of the cord.

NOTE: We recommend using filler blocks if the cabinet front hangs below the cabinet bottom shelf. **IMPORTANT:** If filler blocks are not used, case damage may occur from over tightening screws.

NOTE: When mounting the microwave oven, thread power cord through hole in bottom of top cabinet. Keep it tight throughout Steps 1-3. Do not pinch cord or lift oven by pulling cord.

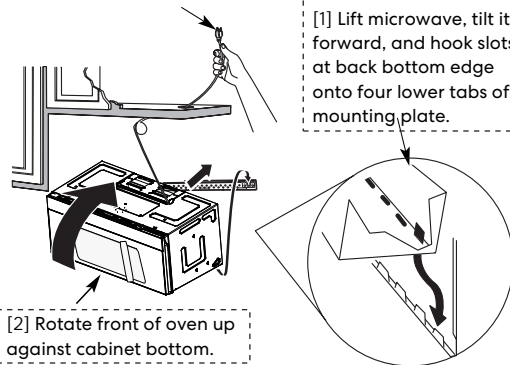

[1] Lift microwave, tilt it forward, and hook slots at back bottom edge onto four lower tabs of mounting plate.

[2] Rotate front of oven up against cabinet bottom.

[3] Insert a self-aligning screw through top center cabinet hole. Temporarily secure the oven by turning the screw at least two full turns after the threads have engaged (It will be completely tightened later.) Be sure to keep power cord tight. Be careful not to pinch the cord, especially when mounting flush to bottom of cabinet.

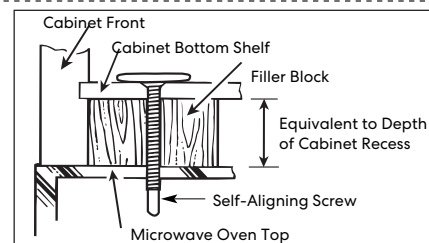

[4] Attach the microwave oven to the top cabinet.

C. Recirculating (Non Vented Ductless)

C4. MOUNT THE MICROWAVE OVEN (cont.)

[5] Insert 2 self-aligning screws through outer top cabinet holes. Turn two full turns on each screw.

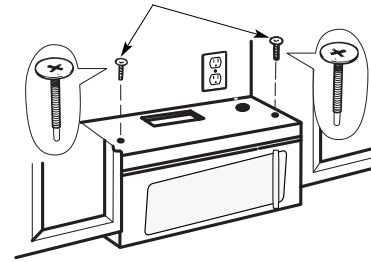

[6] Tighten the outer two screws to the top of the microwave oven. (While tightening screws, hold the microwave oven in place against the wall and the top cabinet.)

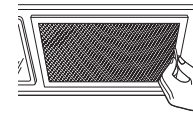

[7] Install grease filters. See the Use & Care Guide packed with the microwave.

C5. INSTALLING OR CHANGING THE CHARCOAL FILTER (Some Models)

NOTE: The charcoal filter is factory installed in some models. Refer to the Use & Care Guide to see if yours is factory installed and for replacement information.

For models without the recirculation filter access door, follow these steps to replace or install a charcoal filter:

[2] Open the microwave door and remove the two vent mounting screws located on top of the microwave using a #1 Phillips screwdriver.

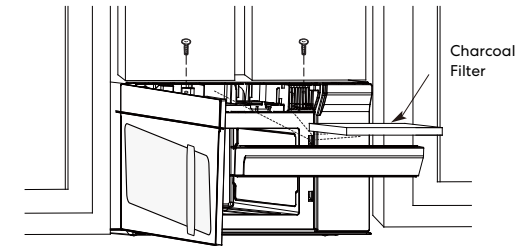

[3] Remove the charcoal filter by pushing the top of the filter inwards, then pull it forward out from the unit.

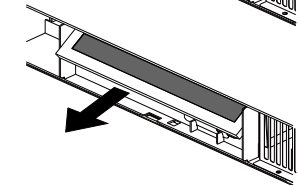
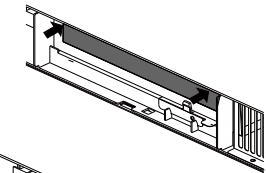

[4] Slide the top of the new charcoal filter into the top of the filter cavity.

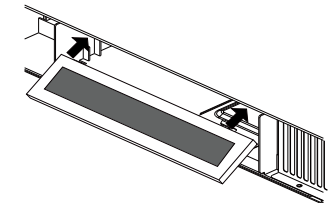

[1] Unplug microwave oven or disconnect power.

- 5 Press the bottom of charcoal filter to place it into the correct position.

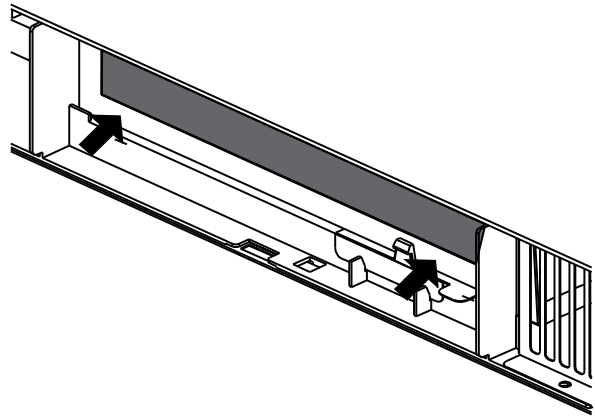

- 6 Reinstall the vent by sliding the bottom of the vent into place. Push the vent top into position and slide right into place. Replace the two vent mounting screws located on top of the microwave using a #1 Phillips screwdriver.

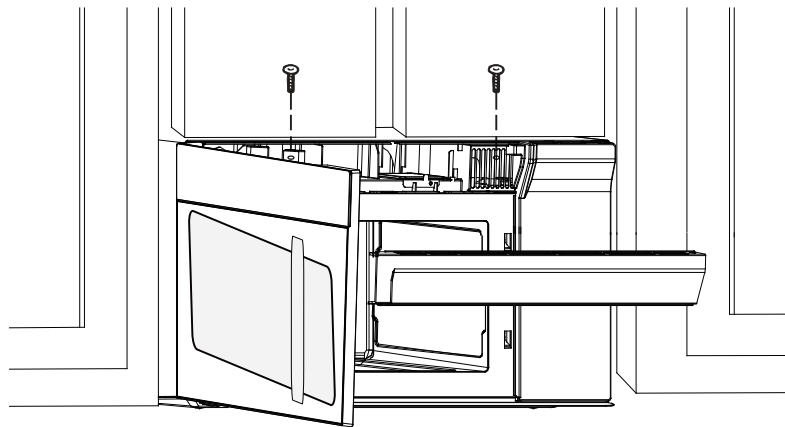

- 7 Close the microwave door. Plug in microwave oven or reconnect power.

BEFORE YOU USE YOUR MICROWAVE

1. Make sure the microwave oven has been installed according to instructions.



2. Remove all packing material from the microwave oven.

3. Install turntable ring and glass tray in cavity.

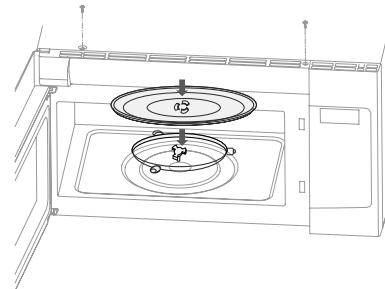

4. Plug power cord into a separate and dedicated 15- to 20-amp electrical outlet.

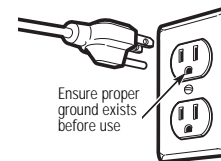

5. Replace house fuse or turn breaker back on.



6. Read the USE & CARE Manual.



7. KEEP INSTALLATION INSTRUCTIONS FOR THE LOCAL INSPECTOR'S USE.



8. FILL OUT PRODUCT REGISTRATION CARD AND SEND IN.



Operational check

1. Make sure the unit has been installed according to these instructions.
2. Remove all packing materials from the oven.
3. Replace house fuse or turn circuit breaker back on.
4. Plug power cord into receptacle .
5. Read operating instructions before testing the product.
6. Turn on the exhaust fan at Turbo speed and confirm it is operating by using a tissue (it will stick to the filter). 7. Confirm the outdoor exhaust flapper has opened.
8. Set the microwave oven for 1 minute and confirm the oven is operating normally using a cup of water.
9. Keep these installation instruction for the local electrical inspector's use.

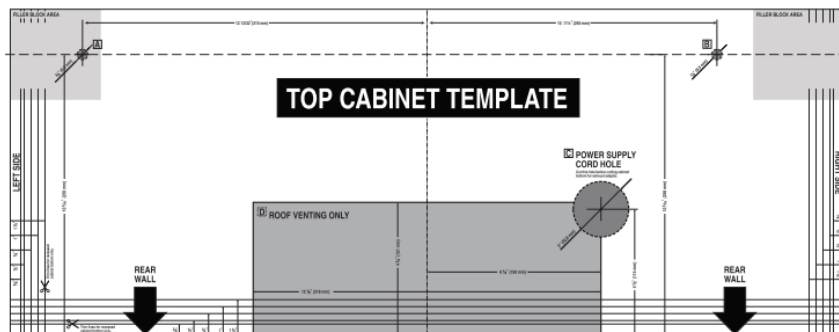
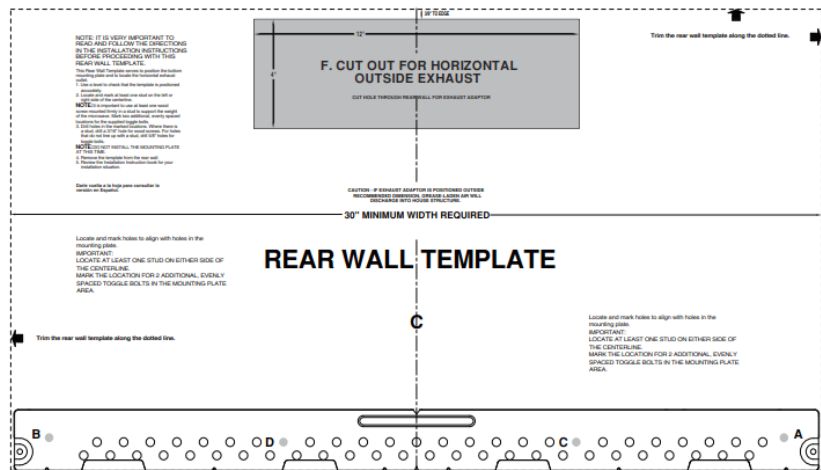



APPLIANCES

WARRANTY AND SERVICE

For full warranty details on this product please visit:
<http://www.cosmoappliances.com/warranty>

TO RECEIVE WARRANTY SERVICE, YOUR
PRODUCT MUST BE REGISTERED. TO REGISTER, VISIT:

WWW.COSMOAPPLIANCES.COM/WARRANTY

SCAN TO REGISTER



IMPORTANT

Do Not Return This Product To The Store If
you have a problem with this product, please contact

Cosmo Customer Support at

+1(888)784-3108

DATED PROOF OF PURCHASE, MODEL #, AND SERIAL #
REQUIRED FOR WARRANTY SERVICE

IMPORTANT

Ne pas Réexpédier ce Produit au Magasin
Pour tout problème concernant ce produit, veuillez contacter
le service des consommateurs Cosmo Customer Support au

+1(888) 784-3108

UNE PREUVE D'ACHAT DATEE EST REQUISE POUR BENEFICIER DE
LA GARANTIE.

IMPORTANTE

No regrese este producto a la tienda
Si tiene algún problema con este producto, por favor contacte el
AYUDA AL CLIENTE COSMO al

+1(888)784-3108

(Válido solo en E.U.A).

NECESITA UNA PRUEBA DE DE COMPRA FECHADA, NÚMERO DE
MODELO Y DE SERIE PARA EL SERVICIO DE LA GARANTÍA

Correct Disposal of this product:

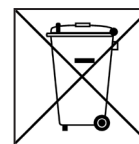

This marking indicates that this appliance should not
be disposed with other household wastes. To prevent
possible harm to the environment or human health
from uncontrolled waste disposal, recycle it responsibly to
promote the sustainable reuse of material resources.



Cosmo is constantly making efforts to improve the quality and performance of our products, so we may make changes to our appliances without updating this manual.

Electronic version of this manual is available at:
www.cosmoappliances.com