

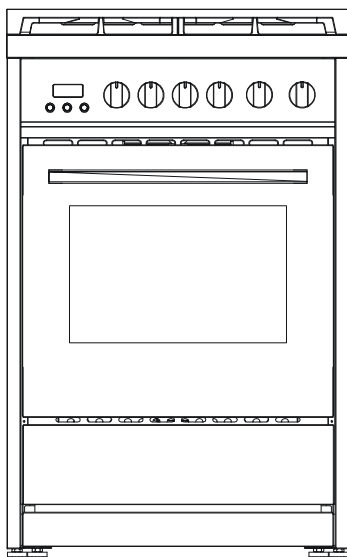

GAS RANGE

COS-244AGC



24-IN FREESTANDING RANGE

INSTALLATION MANUAL

IMPORTANT: READ AND SAVE THESE INSTRUCTIONS.
FOR RESIDENTIAL USE ONLY.

INSTALLER: PLEASE LEAVE THIS GUIDE WITH THE HOMEOWNER.

HOMEOWNER: PLEASE KEEP THIS GUIDE FOR FUTURE REFERENCE.

THANK YOU FOR YOUR PURCHASE

Thank you for your purchase. We know that you have many brands and products to choose from and we are honored to know that you have decided to take one of our products into your home and hope that you enjoy it.

COSMO Appliances are designed according to the strictest safety and performance standard for the North American market. We follow the most advanced manufacturing philosophy. Each appliance leaves the factory after thorough quality inspection and testing. Our distributors and our service partners are ready to answer any questions you may have regarding how to install, use and care for your products. We hope that this manual will help you learn to use the product in the safest and most effective manner.

Before using this product, please read through this manual carefully. Keep this user manual in a safe place for future reference. Please ensure that other persons using this product are familiar with these instructions as well.

If you have any questions or concerns, please contact the dealer from whom you purchased the product, or contact our Customer Support at:

1-888-784-3108

Reach us online at:

www.cosmoappliances.com

TABLE OF CONTENTS

RANGE SAFETY	3
Anti-tip Device	4
INSTALLATION REQUIREMENTS	6
Tools and Parts	6
Location Requirements	8
Product Dimensions	10
Clearances.....	11
Venting Requirements.....	12
Electrical Requirements.....	13
Gas Supply Requirements	16
INSTALLATION INSTRUCTIONS	19
Unpack Range	19
Install Anti-tip Device	20
Install Backsplash.....	22
Gas Connection	23
Complete Connection	25
Adjust Flame Height	27
Level Range	28
GAS CONVERSION	30
Convert Gas Pressure Regulator	31
Convert Surface Burners	32
Convert Oven Bake Burner.....	34
Convert Oven Broil Burner.....	35
Complete Gas Conversion.....	35

RANGE SAFETY

WARNING



Fire Hazard

If the information in this manual is not followed exactly, a fire or explosion may result causing property damage, personal injury or death.

- Do not store or use gasoline or other flammable vapors and liquids in the vicinity of this or any other appliance.
- WHAT TO DO IF YOU SMELL GAS
 - Do not try to light any appliance.
 - Do not touch any electrical switch.
 - Do not use any phone in your building.
 - Clear the room, building, or area of all occupants.
 - Immediately call your gas supplier from a neighbor's phone. Follow the gas supplier's instructions.
 - If you cannot reach your gas supplier, call the fire department.
- Installation and service must be performed by a qualified installer, service agency or the gas supplier.

WARNING

Never Operate the Top Surface Cooking Section of this Appliance Unattended.

- Failure to follow this warning statement could result in fire, explosion, or burn hazard that could cause property damage, personal injury, or death.
- If a fire should occur, keep away from the appliance and immediately call your fire department.

DO NOT ATTEMPT TO EXTINGUISH AN OIL/GREASE FIRE WITH WATER

⚠ WARNING

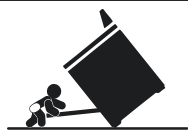

Tip Over Hazard

- A child or adult can tip the range and be killed.
- Install anti-tip bracket to floor or wall per installation instructions.
- Slide range back so rear range foot is engaged in the slot of the anti-tip bracket.
- Re-engage the anti-tip bracket if range is moved.
- Do not operate the range without anti-tip bracket installed and engaged.
- Failure to follow these instructions can result in death or serious burns to children and adults.

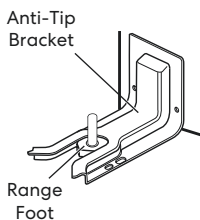

Making sure the anti-tip bracket is installed:

- Slide range forward.
- Look for the anti-tip bracket securely attached to floor and wall.
- Slide range back so rear range foot is under anti-tip bracket.

WARNING: Gas leaks cannot always be detected by smell.

Gas suppliers recommend that you use a gas detector approved by UL or CSA.

For more information, contact your gas supplier.

WARNING: Do not install a ventilation system that blows air downward toward this cooking appliance. This type of ventilation system may cause ignition and combustion problems with this cooking appliance resulting in personal injury or unintended operation.

Your safety and the safety of others are very important.

We have provided many important safety messages in this manual and on your appliance. Always read and obey all safety messages.



This is the safety alert symbol.

This symbol alerts you to potential hazards that can kill or hurt you and others.

All safety messages will follow the safety alert symbol and either the word "DANGER," "WARNING" or "CAUTION." These words mean:

 **DANGER**

You can be killed or seriously injured if you don't immediately follow instructions.

 **WARNING**

You can be killed or seriously injured if you don't follow instructions.

 **CAUTION**

A potentially hazardous situation which, if not avoided, could result in minor or moderate injury.

All safety messages will tell you what the potential hazard is, tell you how to reduce the chance of injury, and tell you what can happen if the instructions are not followed.

In the State of Massachusetts, the following installation instructions apply:

- Installations and repairs must be performed by a qualified or licensed contractor, plumber, or gasfitter qualified or licensed by the State of Massachusetts.
- If using a ball valve, it shall be a T-handle type.
- A flexible gas connector, when used, must not exceed 3 feet.

California Proposition 65 Warning

 **WARNING:**

Cancer and Reproductive Harm - www.P65Warnings.ca.gov.

INSTALLATION REQUIREMENTS

TOOLS AND PARTS

Gather the required tools and parts before starting installation. Read and follow the instructions provided with any tools listed here.

Tools Needed

- Tape measure
- Flat-blade screwdriver
- Phillips screwdriver
- Level
- Drill
- Adjustable wrench or pliers
- Pipe wrench
- 1/8" (3.2 mm) drill bit (for wood floors)
- Masonry drill bit (for concrete/ceramic floors only)
- Marker or pencil
- Pipe-joint compound resistant to Propane gas
- Noncorrosive leak-detection solution

For Propane/Natural Gas Conversions

- Combination wrench
- Nut drive
- Masking tape

Parts Supplied

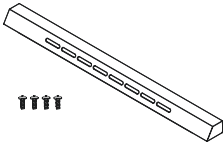

Backsplash with screws

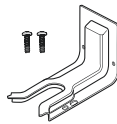

Anti-tip bracket with screws



Gas pressure regulator



Gas pipe adapter with washers

Parts Needed



Gas supply line kit
(supply line and 2 adapters)

Optional Parts

To purchase these or any other accessories, please visit www.cosmoappliances.com or reference the contact information at the end of this manual.

- LP conversion kits



Scan to find
available LP kits

LOCATION REQUIREMENTS

IMPORTANT: Observe all governing codes and ordinances. Do not obstruct flow of combustion and ventilation air.

- It is the installer's responsibility to comply with installation clearances specified on the model/serial rating plate. The model/serial rating plate is located behind the oven door on the oven frame.

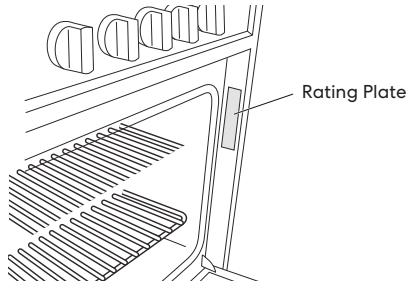

- The range should be located for convenient use in the kitchen.
- Recessed installations must provide complete enclosure of the sides and rear of the range.
- To eliminate the risk of burns or fire by reaching over heated surface units, cabinet storage space located above the surface units should be avoided. If cabinet storage is to be provided, the risk can be reduced by installing a range hood or microwave hood combination that projects horizontally a minimum of 5" (12.7 cm) beyond the bottom of the cabinets.
- All openings in the wall or floor where range is to be installed must be sealed.
- Do not seal the range to the side cabinets.
- Cabinet opening dimensions that are shown must be used.
- Grounded electrical supply is required. See "Electrical Requirements" section.
- Proper gas supply connection must be available. See "Gas Supply Requirements" section.
- Contact a qualified floor covering installer to check that the floor covering can withstand at least 200°F (93°C).
- Use an insulated pad or 1/4" (0.64 cm) plywood under range if installing range over carpeting.

Mobile Home - Additional Installation Requirements

- The installation of this range must conform to the Manufactured Home Construction and Safety Standard, Title 24 CFR, Part 3280 (formerly the Federal Standard for Mobile Home Construction and Safety, Title 24, HUD Part 280). When such standard is not applicable, use the Standard for Manufactured Home Installations, ANSI A225.1/NFPA 501A or with local codes.

In Canada, the installation of this range must conform with the current standards CAN/CSA-A240-latest edition, or with local codes.

Mobile Home Installations Require:

- When this range is installed in a mobile home, it must be secured to the floor during transit. Any method of securing the range is adequate as long as it conforms to the standards listed above.
- Four-wire power supply cord or cable must be used in a mobile home installation. The appliance wiring will need to be revised. See "Electrical Connection" section.

PRODUCT DIMENSIONS

This manual covers several models. Your model may appear different from the models depicted. Dimensions given are maximum dimensions across all models.

COS-244AGC

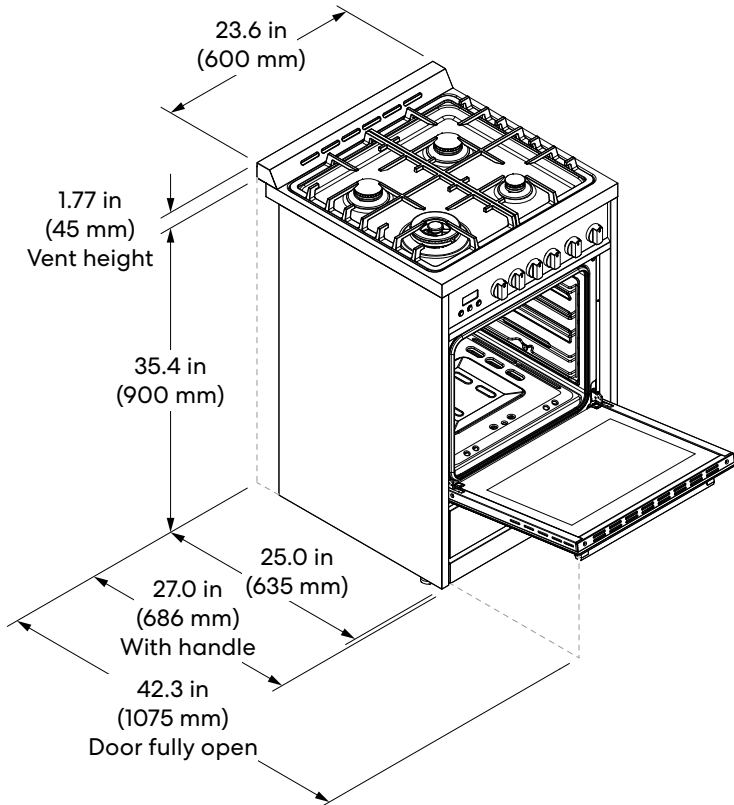

CLEARANCES

IMPORTANT: Some cabinet and building materials are not designed to withstand the heat produced by the oven for baking and self-cleaning. Check with your builder or cabinet supplier to make sure that the materials used will not discolor, delaminate or sustain other damage.

GIVEN DIMENSIONS ARE MINIMUM CLEARANCES.

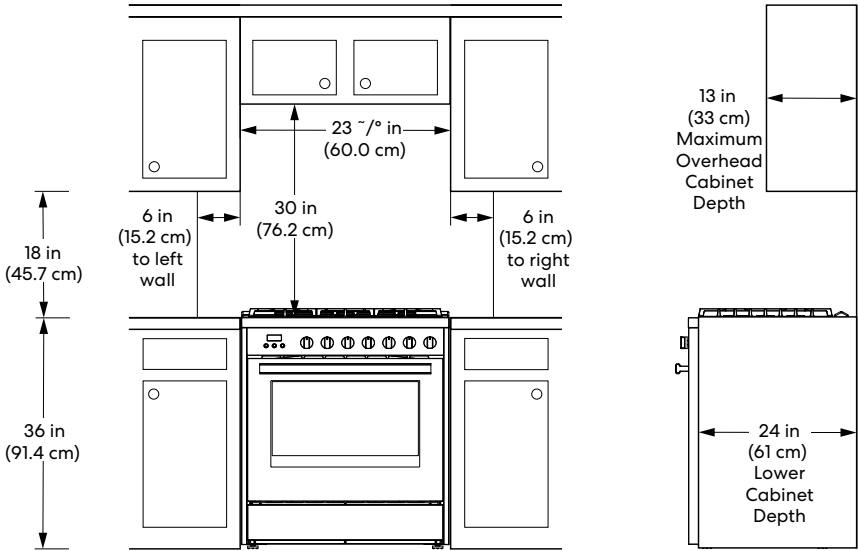

NOTE:

- 30" (76.2 cm) minimum clearance between cooking surface and bottom of the overhead cabinet.
- 18" (45.7 cm) minimum clearance from upper cabinet to countertop on either side of unit.

Power Supply Location

IMPORTANT: An electrical outlet in the floor, may be either recessed or surface mounted, but an electrical outlet in the wall must be recessed to make the connection. For Direct Wiring, the electrical box should be mounted to the wall.

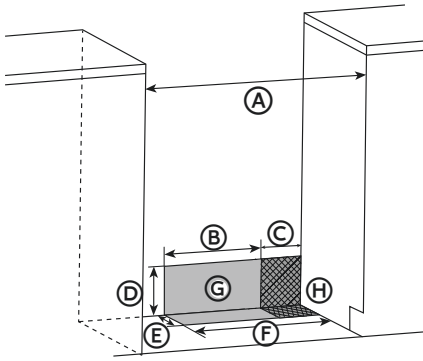

- (A) 30" (76 cm)
- (B) 11½" (29.2 cm)
- (C) 6" (15.2 cm)
- (D) 7¼" (18.4 cm)
- (E) 3" (7.6 cm)
- (F) 17½" (44 cm)
- (G) Recommended Location for Electrical Outlet
- (H) Recommended Location for Gas Supply Connection

VENTING REQUIREMENTS

IMPORTANT: This range must be exhausted outdoors unless you are using ductless venting. Observe all governing codes and ordinances. Do not obstruct flow of combustion and ventilation air.

- Do not terminate the vent system in an attic or other enclosed area.
- Use an approved vent cap for proper performance. If an alternate wall or roof cap is used, be certain the cap size is not reduced and that it has a backdraft damper.
- Vent system must terminate to the outside unless you are using a ductless vent kit.
- Rigid metal vent is recommended. For best performance, do not use plastic or metal foil vent.
- If a joist or stud must be cut, then a supporting frame must be constructed.
- The size of the vent should be uniform.
- The vent system must have a damper.
- Seal all joints in the vent system.
- Use caulking to seal exterior wall or roof opening around the cap.
- Determine which venting method is best for your application.

Makeup Air

Local building codes may require the use of makeup air systems when using ventilation systems greater than specified CFM of air movement. The specified CFM varies from locale to locale. Consult your HVAC professional for specific requirements in your area.

ELECTRICAL REQUIREMENTS

WARNING



Electrical Shock Hazard

Electrically ground range.

Failure to do so can result in death, fire or electrical shock.

Electrical Grounding Instructions

This appliance is equipped with a three-prong grounding plug for your protection against shock hazard and should be plugged directly into a properly grounded receptacle. Do not cut or remove the grounding prong from this plug.

This range is equipped with an electronic ignition system that will not operate if plugged into an outlet that is not properly polarized.

If codes permit and a separate ground wire is used, it is recommended that a qualified electrical installer determine that the ground path is adequate and wire gauge is in accordance with local codes.

Do not use an extension cord.

WARNING: Improper connection of the equipment-grounding conductor can result in a risk of electric shock. Check with a qualified electrician or service technician if you are in doubt as to whether the appliance is properly grounded. Do not modify the power supply cord plug. If it will not fit the outlet, have a proper outlet installed by a qualified electrician.

ELECTRICAL REQUIREMENTS - U.S.A. ONLY

Be sure that the electrical connection and wire size are adequate and in conformance with the National Electrical Code, ANSI/ NFPA No. 70-latest edition and all local codes and ordinances.

A copy of the above code standards can be obtained from:

National Fire Protection Association
1 Batterymarch Park
Quincy, MA 02169

Electrical Connection

- Check local codes and consult gas supplier. Check existing electrical supply and gas supply. It is recommended that all electrical connections be made by a licensed, qualified electrical installer.
- Range must be connected to the proper electrical voltage and frequency as specified on the model/serial rating plate. The plate is located behind the oven door on the oven frame. Refer to the illustrations in the "Location Requirements" section.
- A 120 volt, 60 Hz, AC only, 15-amp fused, electrical circuit is required. A time- delay fuse or circuit breaker is also recommended. It is recommended that a separate circuit serving only this range be provided.
- Electronic ignition systems operate within wide voltage limits, but proper grounding and polarity are necessary. Check that the outlet provides 120-volt power and is correctly grounded.
- This gas range is not required to be plugged into a GFCI (Ground-Fault Circuit Interrupter) outlet. It is recommended that you not plug an electric spark ignition gas range or any other major appliance into a GFCI wall outlet as it may cause the GFCI to trip during normal cycling.
- Performance of this range will not be affected if operated on a GFCI-protected circuit. However, occasional nuisance tripping of the GFCI breaker is possible due to the normal operating nature of electronic gas ranges.
- The wiring diagram is located on the back of the range in a clear plastic bag.

NOTE: The metal chassis of the range must be grounded in order for the control panel to work. If the metal chassis of the range is not grounded, no keypads will operate. Check with a qualified electrician if you are in doubt as to whether the metal chassis of the range is grounded.

ELECTRICAL REQUIREMENTS - CANADA ONLY

Be sure that the electrical connection and wire size are adequate and in conformance with the CSA Standard C22.1, Canadian Electrical Code, Part 1 - latest edition and all local codes and ordinances.

A copy of the above code standards can be obtained from:

Canadian Standards Association
178 Rexdale Blvd.
Toronto, ON M9W 1R3 CANADA

Electrical Connection

- Check local codes and consult gas supplier. Check existing electrical supply and gas supply. It is recommended that all electrical connections be made by a licensed, qualified electrical installer.
- Check with a qualified electrical installer if you are not sure the range is properly grounded.
- A time-delay fuse or circuit breaker is recommended.
- This range is equipped with a CSA International Certified Power Cord intended to be plugged into a standard 14-50R wall receptacle. Be sure the wall receptacle is within reach of range's final location.
- Do not use an extension cord.
- The wiring diagram is located on the back of the range in a clear plastic bag.

NOTE: The metal chassis of the range must be grounded in order for the control panel to work. If the metal chassis of the range is not grounded, no keypads will operate. Check with a qualified electrician if you are in doubt as to whether the metal chassis of the range is grounded.

GAS SUPPLY REQUIREMENTS

WARNING



Explosion Hazard

Use a new CSA International approved gas supply line.

Install a shut-off valve.

Securely tighten all gas connections.

If connected to LP, have a qualified person make sure gas pressure does not exceed the maximum pressure listed in this section.

Examples of a qualified person include:

- licensed heating personnel
- authorized gas company personnel
- authorized service personnel

Failure to do so can result in death, explosion or fire.

IMPORTANT:

- Observe all governing codes and ordinances.
- This installation must conform with all local codes and ordinances. In the absence of local codes, installation must conform with American National Standard, National Fuel Gas Code ANSI Z223.1 - latest edition or, in Canada, CAN/CGA B149 - latest edition.
- Leak testing of the range must be conducted according to the manufacturer's instructions. Do not use a flame to check for leaks.

TYPE OF GAS

Natural Gas:

This range is design-certified by CSA International for use with natural gas or, after proper conversion, for use with LP gas.

This range is factory-set for use with Natural gas. The model/serial rating plate located on the right side oven door trim has information on the types of gas that can be used. If the types of gas listed do not include the type of gas available, check with the local gas supplier.

LP Gas Conversion:

Conversion must be performed by a qualified service technician. The qualified agency performing this work assumes the gas conversion responsibility.

No attempt shall be made to convert the appliance from the gas specified on the model/serial rating plate for use with a different gas without consulting the serving gas supplier. See "GAS CONVERSION" section.

GAS SUPPLY LINE

Provide a gas supply line of 3/4" (1.9 cm) rigid pipe to the range location. A smaller size pipe on longer runs may result in insufficient gas supply. Pipe-joint compounds that resist the action of LP gas must be used. With LP gas, piping or tubing size can be 1/2" (1.3 cm) minimum. Usually, LP gas suppliers determine the size and materials used in the system.

Flexible metal appliance connector:

- If local codes permit, a new CSA design-certified, 4 - 5 ft (122 - 152.4 cm) long, 1/2" (1.3 cm) or 3/4" (1.9 cm) I.D., flexible metal appliance connector may be used for connecting range to the gas supply line.

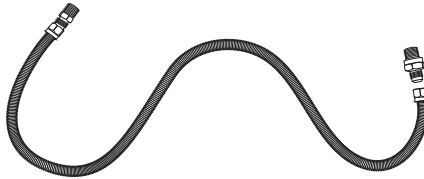

- A 1/2" (1.3 cm) male pipe thread is needed for connection to the female pipe threads of the inlet to the appliance pressure regulator.
- Do not kink or damage the flexible metal tubing when moving the range.

Rigid pipe connection:

Since the range must be pulled away from the installation space to provide access to the gas regulator connections, and because hard piping restricts movement of the range, the range can only be installed using a CSA International-certified flexible metal appliance connector.

If local codes require a hard-piped connection, a combination of pipe fittings must be used to connect the range to the existing gas line and maintain an accessible working space behind the range. Consult with a qualified local technician for an optimal connection suitable for your installation.

Gas shutoff valve:

A manual gas line shut-off valve must be installed in an easily accessible location. Do not block access to shut-off valve. The valve is for turning on or shutting off gas to the range.

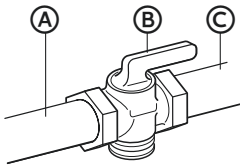

- Ⓐ Gas Supply Line
- Ⓑ Shutoff Valve "Open" Position
- Ⓒ To Range

GAS PRESSURE REGULATOR

The gas pressure regulator supplied with this range must be used. The inlet pressure to the regulator should be as follows for proper operation:

	Natural gas	LP gas
Minimum pressure	4" WCP	10" WCP
Maximum pressure	7" WCP	11" WCP

Contact local gas supplier if you are not sure about the inlet pressure.

Burner Input Requirements

Input ratings shown on the model/serial rating plate are for elevations up to 2,000 ft (609.6 m).

For elevations above 2,000 ft (609.6 m), ratings are reduced at a rate of 4% for each 1,000 ft (304.8 m) above sea level (not applicable for Canada).

GAS SUPPLY PRESSURE TESTING

Gas supply pressure for testing regulator must be at least 1" (2.5 cm) water column pressure above the manifold pressure shown on the model/serial rating plate.

Line pressure testing above 0.5 psi gauge (14" WCP)

The range and its individual shutoff valve must be disconnected from the gas supply piping system during any pressure testing of that system at test pressures in excess of 0.5 psi (3.5 kPa).

Line pressure testing at 0.5 psi gauge (14" WCP) or lower

The range must be isolated from the gas supply piping system by closing its individual manual shutoff valve during any pressure testing of the gas supply piping system at test pressures equal to or less than 1/2 psi (3.5 kPa).

INSTALLATION INSTRUCTIONS

IMPORTANT: This appliance shall be installed only by authorized persons and in accordance with the manufacturer's installation instructions, local gas fitting regulations, municipal building codes, electrical wiring regulations, local water supply regulations.

UNPACK RANGE

WARNING

Excessive Weight Hazard

Use two or more people to move and install range.

Failure to do so can result in back or other injury.

1. Remove shipping materials, tape and film from the range. Keep cardboard bottom under range. Do not dispose of anything until the installation is complete.
2. Remove oven racks and parts package from oven and shipping materials.
3. To remove cardboard bottom, first take 4 cardboard corners from the carton. Stack one cardboard corner on top of another. Repeat with the other 2 corners. Place them lengthwise on the floor behind the range to support the range when it is laid on its back.
4. Using two or more people, firmly grasp the range and gently lay it on its back on the cardboard corners.
5. Remove cardboard bottom.

NOTES:

- The leveling legs can be adjusted while the range is on its back.
- To place range back up into a standing position, put a sheet of cardboard or hardboard on the floor in front of range to protect the flooring. Using two or more people, stand range back up onto the cardboard or hardboard.

INSTALL ANTI-TIP DEVICE

⚠ WARNING



Tip Over Hazard

- A child or adult can tip the range and be killed.
- Install anti-tip bracket to floor or wall per installation instructions.
- Slide range back so rear range foot is engaged in the slot of the anti-tip bracket.
- Re-engage the anti-tip bracket if range is moved.
- Do not operate the range without anti-tip bracket installed and engaged.
- Failure to follow these instructions can result in death or serious burns to children and adults.

IMPORTANT:

- An anti-tip bracket is provided with the range. The anti-tip bracket uses a rear range foot to secure the range to the floor or wall.
- Attach the anti-tip bracket to the floor or wall so that the rear range foot will be centered within the bracket when the range is pushed into its final position.

1. Remove the anti-tip bracket and screws from the parts bag.

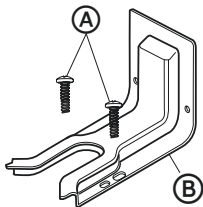

- Ⓐ 16 x 1 $\frac{1}{8}$ " Screws (2)
- Ⓑ Anti-tip Bracket

NOTE: The anti-tip bracket must be securely mounted to the subfloor or wall. The flooring's thickness may require longer screws to anchor bracket to subfloor.

- Place the bracket so that the back of the bracket is against the rear wall and the side edge of the bracket is $3/8"$ to $1/2"$ from the adjacent cabinet.

NOTE: If there is no adjacent cabinet, place the bracket so that the edge of the bracket is $3/8"$ to $1/2"$ in from the range side panel. If the countertop overhangs the cabinet, offset the bracket from the cabinet by the depth of the overhang plus an additional $3/8"$ to $1/2"$.

- Using the anti-tip bracket as a template, mark the two holes for either a Floor Wood, Floor Concrete, or Wall installation, as shown.

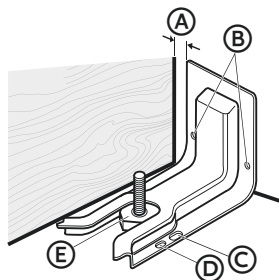

- (A) Distance from Adjacent Cabinet ($3/8"$ to $1/2"$ [0.95 cm to 1.27 cm])
- (B) Wall Holes
- (C) Concrete Floor Holes
- (D) Wood Floor Holes
- (E) Rear Range Foot

- Drill two pilot holes where marked. Follow the instructions specific to your construction.

NOTE: A nail or awl may be used to create a pilot hole, if a drill is not available. For concrete construction $1/4" \times 1\ 1/2"$ Lag Bolts and $1/2"$ O.D. Sleeve Anchors are required.

Wood

- Floor - Drill a $1/8"$ pilot hole, as shown.

NOTE: Contact a qualified floor covering installer for the best procedure for drilling mounting holes through your type of floor covering.

- Wall - Drill an angled $1/8"$ pilot hole, as shown.

Concrete

- Drill the size hole recommended for the anchors into the concrete at the center of the holes identified as Floor Concrete or Wall.

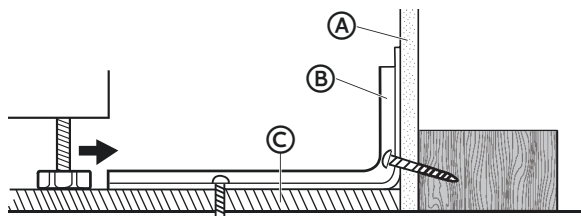

- (A) Wall
- (B) Anti-tip Bracket
- (C) Floor

5. Install the anti-tip bracket.

Wood

- Using the two screws (provided) fasten the anti-tip bracket to the floor or wall.

NOTE: The screw must enter wood or metal.

Concrete

- Insert the sleeve anchor into the drilled holes and then insert the lag bolts through the anti-tip bracket and into the floor or wall. The bolts must be properly tightened as recommended for the hardware.

INSTALL BACKSPLASH

- Install the backsplash to rear of range with the screws provided.

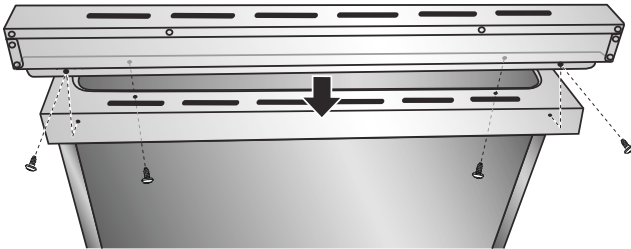

GAS CONNECTION

WARNING



Explosion Hazard

Use a new CSA International approved gas supply line and install a shut-off valve for new installations.

Securely tighten all gas connections.

If connected to LP, have a qualified person make sure gas pressure does not exceed the maximum pressure listed in the "Gas Supply Requirement" section.

Examples of a qualified person include:

- licensed heating personnel
- authorized gas company personnel
- authorized service personnel

Failure to do so can result in death, explosion or fire.

This appliance shall be installed only by authorized persons and in accordance with the manufacturer's installation instructions, local gas fitting regulations, municipal building codes, electrical wiring regulations, local water supply regulations. The agency performing this work assumes responsibility for the quality of work performed, including checking for leaks and ensuring installation meets code requirements.

This range is factory-set for use with Natural gas. To use this range with Propane gas, see the "GAS CONVERSION" section before connecting this range to the gas supply. Gas conversions from Natural gas to Propane gas or from Propane gas to Natural gas must be done by a qualified installer.

TYPICAL FLEXIBLE CONNECTION

1. Apply pipe-joint compound made for use with LP gas to the smaller thread ends of the flexible connector adapters.

- Attach one adapter to the gas pressure regulator and the other adapter to the gas shutoff valve. Tighten both adapters, being certain not to move or turn the gas pressure regulator.

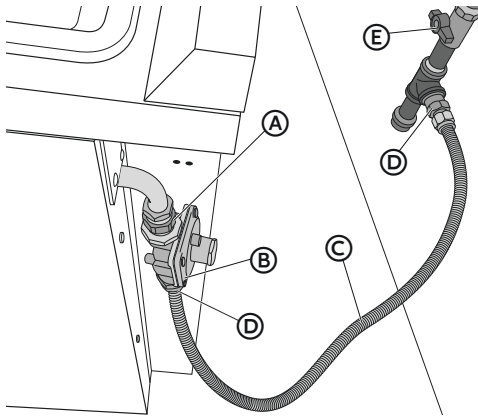

- (A) Adapter (provided)
- (B) Gas Pressure Regulator
- (C) Gas Supply Line
- (D) Adapters (From Gas Supply Line Kit)
- (E) Gas Shutoff Valve

- Use a 15/16" (2.4 cm) combination wrench and channel lock pliers to attach the flexible connector to the adapters. Check that connector is not kinked.

TYPICAL RIGID PIPE CONNECTION

A combination of pipe fittings must be used to connect the range to the existing gas line and maintain an accessible working space behind the range. Your connections may be different according to the supply line type, size and location. Consult with a qualified local technician for an optimal connection suitable for your installation.

- Apply pipe-joint compound made for use with LP gas to all pipe thread connections.
- Using a pipe wrench to tighten, connect the gas supply to the range.

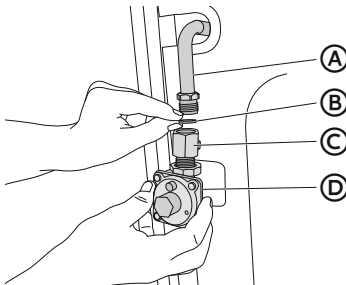

- (A) Gas Line from Range
- (B) Washer (provided)
- (C) Adapter (provided)
- (D) Gas Pressure Regulator (provided)

CONVERT TO LP GAS (OPTIONAL)

This range is shipped from the factory set up to use natural gas. It can be converted to use LP gas by a qualified service technician.

The LP conversion kit is sold separately. The conversion to LP requires all surface burner orifices and, if applicable, gas oven orifices to be changed. In addition, the nozzle on the gas pressure regulator needs to be reversed.

See "GAS CONVERSION" section for detailed instructions.

NOTE: All replaced orifices must be left with the consumer, including the instructions and retrofit sizes and orifice indication.

COMPLETE INSTALLATION

WARNING



Electrical Shock Hazard

Disconnect power before servicing.

Plug into a grounded 3-prong outlet.

Do not use an adapter or an extension cord.

Failure to do so can result in death, fire, or electrical shock

1. Open the manual shutoff valve in the gas supply line. The valve is open when the handle is parallel to the gas pipe.
2. Test all connections by brushing on an approved noncorrosive leak-detection solution. If bubbles appear, a leak is indicated. Correct any leak found.

- Remove, if any, packaging tapes securing the burners on the surface. If the cooktop burner bases and caps are not pre-installed, remove them from package containing parts, align and place the burner bases and caps accordingly.

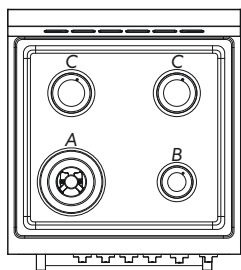

- A. Triple Ring (X-Large)
- B. Auxiliary (Small)
- C. Semi Rapid (Medium)

Note: Align notches in burner caps with pins in burner base. Burner caps should be level when properly positioned. If burner caps are not properly positioned, surface burners will not light.



Auxiliary Burner
Semi Rapid Burner
Rapid Burner



Triple Ring Burner

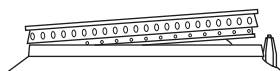

Incorrectly Positioned

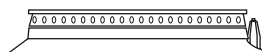

Correctly Positioned

- Place burner grates over burners and caps.
- Plug in range or reconnect power.

ADJUST FLAME HEIGHT

Check and adjust the height of top burner flames. The cooktop "low" burner flame should be a steady blue flame approximately 1/4" (6 mm) high. Propane gas flames have a slightly yellow tip.

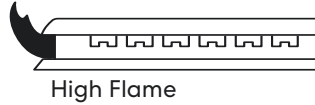
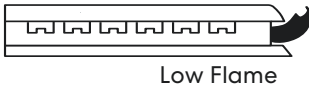

If burners do not light properly:

1. Turn burner control knob to the "OFF" position.
2. Check that the range is plugged in. Check that the circuit breaker has not tripped or the household fuse has not blown.
3. Check that the gas shutoff valves are set to the "open" position.
4. Check that burner caps are properly positioned on burner bases.

To adjust standard burner:

IMPORTANT: Adjustments must be made with two other burners in operation on a medium setting. This prevents the upper row of flames from being set too low, resulting in the flame being extinguished when other burners are turned on.

The flame can be adjusted using the adjustment screw in the center of the valve stem. The valve stem is located directly behind the control knob.

1. Light the burner and turn the knob to the lowest setting (MIN).
2. Pull and remove the control knob.
3. Insert a small, flat-blade screwdriver into the adjustment screw, and slowly turn the screw until the flame appearance is correct.
 - Open the valve more if the flames are too small or fluttered.
 - Close the valve more if the flames are too large.

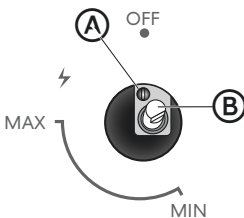

- (A) Adjustment Screw
- (B) Control Knob Stem

4. Replace the control knob.
5. Test and check the flame by turning the control knob from the lowest to the highest settings.

NOTE: For burners (on some models) with safety valve, make sure that the regulation obtained is sufficient to maintain heating of the thermocouple. If it is not, increase the minimum flame.

ABNORMAL OPERATION

ANY OF THE FOLLOWING ARE CONSIDERED TO BE ANBORMAL OPERATION AND MAY REQUIRE SERVICING:

- Yellow burner flames.
- Sooting up of cooking utensils.
- Burners not igniting properly.
- Burners failing to remain lit.
- Burners extinguished by oven door.
- Gas valves, which are difficult to turn.

IN CASE THE APPLIANCE FAILS TO OPERATE CORRECTLY, CONTACT THE AUTHORIZED SERVICE PROVIDE IN YOUR AREA.

THE BURNERS REQUIRE NO REGULATION OF THE PRIMARY AIR.

LEVEL RANGE

IMPORTANT: Do not operate the range if its rear foot is not completely engaged in the anti-tip bracket. Never completely remove the leveling legs or the range will not be secured to the anti-tip device properly.

1. Slide range into final location, making sure rear leveling leg slides into the anti- tip bracket. Leave a 1" (2.5 cm) gap between the back of the range and the back wall.
2. Check that the range is level by placing a level on the oven bottom. If needed, use a wrench to adjust the height of the leveling legs until the range is level from side to side and from front to back.

NOTE: The range must be level for optimum cooking and baking performance.

VERIFY ANTI-TIP BRACKET ENGAGEMENT

1. Place the outside of your foot against the bottom of the front panel to keep the range from moving, and then grasp the back of the range, as shown.

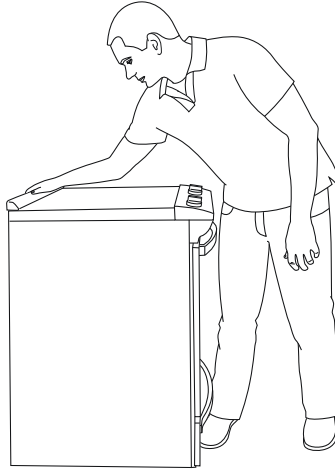

2. Slowly attempt to tilt the range forward.

- If you encounter immediate resistance, the range foot is engaged in the anti-tip bracket. Range installation is completed.
- If the rear of the range lifts more than 1/2" (1.3 cm) off the floor without resistance, stop tilting the range and lower it gently back to the floor. The range foot is not engaged in the anti-tip bracket. Proceed to Steps 3 and 4.

IMPORTANT: If there is a snapping or popping sound when tilting the range, the range may not be fully engaged in the bracket. Check to see if there are obstructions keeping the range from sliding to the wall or keeping the range foot from sliding into the bracket. Verify that the bracket is held securely in place by the mounting screws.

3. Slide the range forward, and verify that the anti-tip bracket is securely attached to the floor or wall.
4. Slide range back so the rear range foot is inserted into the slot of the anti-tip bracket.

IMPORTANT: If the range is pulled away from the wall for any reason, always verify anti-tip bracket engagement again.

GAS CONVERSION

WARNING



Explosion Hazard

Use a new CSA International approved gas supply line and install a shut-off valve for new installations.

Securely tighten all gas connections.

If connected to LP, have a qualified person make sure gas pressure does not exceed the maximum pressure listed in the "Gas Supply Requirement" section.

Examples of a qualified person include:

- licensed heating personnel
- authorized gas company personnel
- authorized service personnel

Failure to do so can result in death, explosion or fire.

WARNING



Tip Over Hazard

- A child or adult can tip the range and be killed.
- Install anti-tip bracket to floor or wall per installation instructions.
- Slide range back so rear range foot is engaged in the slot of the anti-tip bracket.
- Re-engage the anti-tip bracket if range is moved.
- Do not operate the range without anti-tip bracket installed and engaged.
- Failure to follow these instructions can result in death or serious burns to children and adults.

LP/PROPANE GAS CONVERSION

IMPORTANT: Gas conversions must be done by a qualified service technician in accordance with the manufacturer's instructions and all codes and requirements of the authority having jurisdiction. The qualified agency performing this work assumes the gas conversion responsibility.

Convert Gas Pressure Regulator

1. Turn manual shutoff valve to the closed position.
2. Unplug range or disconnect power.
3. Locate the gas pressure regulator on the back of the range.

IMPORTANT: Do not remove the gas pressure regulator.

4. Unscrew the regulator cap with the wrench.

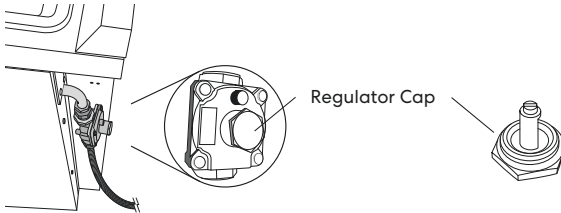

5. Remove the retainer pin that is currently positioned for use with natural gas.

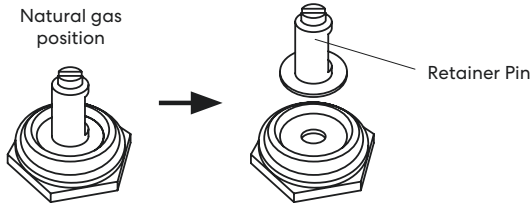

6. Turn the retainer pin upside down and place it back into the regular cap. The regular cap is now positioned for use with LP gas.

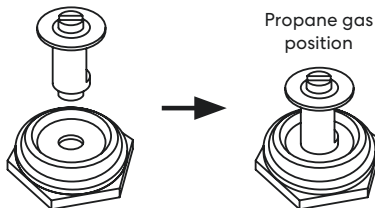

7. Screw and tighten the regulator cap back into the gas pressure regulator with the wrench.

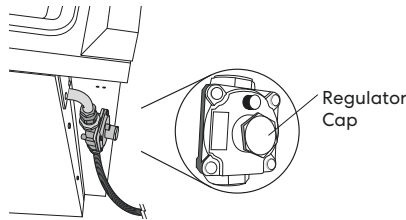

Convert Surface Burners

1. If installed, remove the burner grates.
2. Remove the burner grates, burner caps, and the burner base.

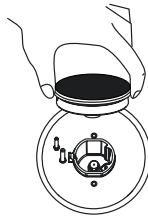

3. Remove the natural gas orifices with a 9/32" (7 mm) nut driver.

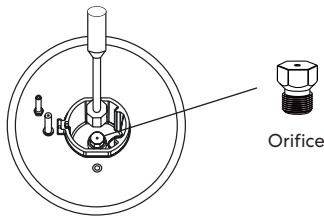

4. Replace the natural gas orifices with the correct LP gas orifices from the LP conversion kits. LP gas orifices are stamped with a size. Refer to the following chart for correct LP gas orifice ratings and sizes for proper placement.

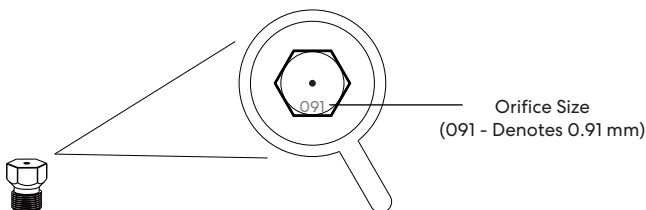

Orifice Chart for Surface and Oven Burners: COS-244AGC

Burner	Placement	Orifice Type	Orifice Size (mm)	Burner Rating
Triple Ring	Front Left	NG	2.10	18,000 BTU
		LP	1.22	17,000 BTU
Auxiliary	Front Right	NG	1.05	5,000 BTU
		LP	0.70	
Semi Rapid	Rear Left	NG	1.29	6,900 BTU
		LP	0.80	
Semi Rapid	Rear Right	NG	1.29	6,900 BTU
		LP	0.80	
Broil	Oven Top	NG	1.15	5,800 BTU
		LP	0.72	
Bake	Oven Bottom	NG	1.85	8,500 BTU
		LP	1.10	

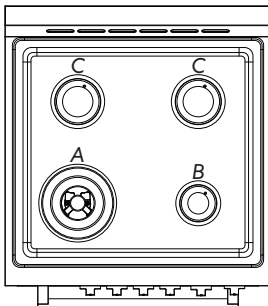

- A. Triple Ring (X-Large)
- B. Auxiliary (Small)
- C. Semi Rapid (Medium)

5. Keep and store natural gas orifices in case of re-installation with natural gas.
6. Replace the burner base, the burner caps, and the burner grates.

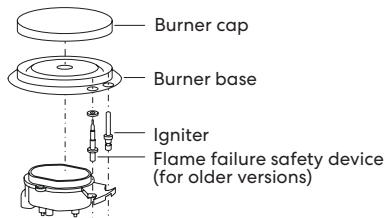

Convert Oven Bake Burner

1. Remove Bake Burner Cover

Open your oven door and unscrew the back two screws of bake burner cover. Remove the bake burner cover.

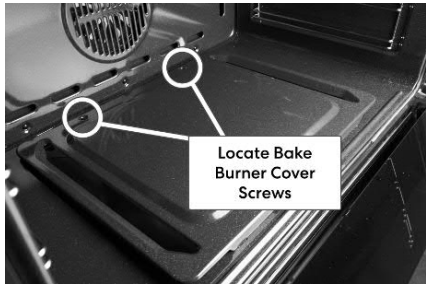

2. Remove Flame Spread Plate

Unscrew the four screws of the flame spread plate. Remove the flame spread plate.

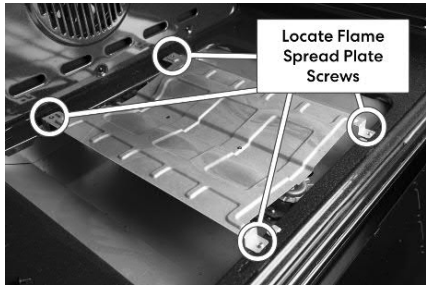

3. Slide Out Burner

Unscrew the front two screws holding the burner in place. Slide out the burner up and towards oven door out of the socket, careful not to sever or pull on the wire.

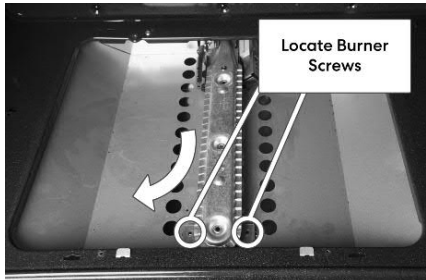

4. Change the Burner Orifice

Move the burner carefully to gain access to the burner orifice, careful not to sever or pull on the wire. Proceed with changing the orifice.

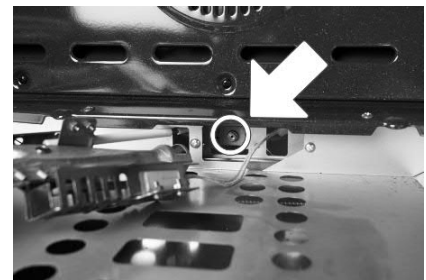

Convert Oven Broil Burner

1. Unscrew Front Bracket

Locate the bracket at the front of the broiler. Remove the screw.



2. Remove the Burner

Carefully slide the burner forward and out of the socket, without severing or damaging the wire attached. Carefully lay the burner down as shown in the image to the right.



3. Change the Burner Orifice

With the burner out of the way look for the orifice as shown. Continue with changing the orifice.

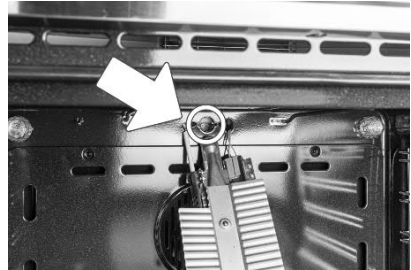

Complete Gas Conversion

1. Open shutoff valve in the gas supply line.

2. Plug in cooktop or reconnect power.

- Refer to "Gas Connection" section in the "Installation Instructions" section for proper connection of the range to the gas supply.
- Refer to "Complete Installation" section to complete this procedure.
- Refer to the "Adjust Flame Height" section for burner flame adjustments.

IMPORTANT: You may have to adjust the low setting for each cooktop burner.

IMPORTANT

Do Not Return This Product To The Store

If you have a problem with this product, please contact COSMO Customer Support at

+1 (888) 784-3108

DATED PROOF OF PURCHASE, MODEL #, AND SERIAL # REQUIRED FOR WARRANTY SERVICE.

IMPORTANT

Ne pas Réexpédier ce Produit au Magasin

Pour tout problème concernant ce produit, veuillez contacter le service des consommateurs Cosmo Customer Support au

+1 (888) 784-3108

UNE PREUVE D'ACHAT DATEE EST REQUISE POUR BENEFICIER DE LA GARANTIE.

IMPORTANTE

No regrese este producto a la tienda

Si tiene algún problema con este producto, por favor contacte el ayuda al cliente COSMO al

+1 (888) 784-3108

(Válido solo en E.U.A.)

NECESITA UNA PRUEBA DE DE COMPRA FECHADA, NÚMERO DE MODELO Y DE SERIE PARA EL SERVICIO DE LA GARANTÍA.



Correct Disposal of this product:

This marking indicates that this appliance should not be disposed with other household wastes. To prevent possible harm to the environment or human health from uncontrolled waste disposal, recycle it responsibly to promote the sustainable reuse of material resources.

MEMO

MEMO



APPLIANCES

Cosmo is constantly making efforts to improve the quality and performance of our products, so we may make changes to our appliances without updating this manual.

Electronic version of this manual is available at:
www.cosmoappliances.com