



**CATALOGO
GENERALE**



ENJOY YOUR FREE TIME



LA NOSTRA AZIENDA

K39 Srl è una giovane realtà con sede nell'immediato hinterland milanese, a Garbagnate Milanese.

Fondata nel 2016, l'azienda parte da un pedigree importante nel settore degli accessori auto. I fondatori provengono da aziende di produzione e commercializzazione di accessori e ricambi con esperienza pluridecennale. L'azienda produce e commercializza barre portatutto, porta bici e porta sci. La costruzione degli stampi trancia e stampi iniezione materia plastica per la produzione dei propri articoli avviene interamente all'interno di K39 SRL grazie ad un reparto macchine a controllo numerico.

Recentemente K39 Srl è entrata a far parte del gruppo industriale facente capo a Profilati Alluminio Srl, azienda storica italiana attiva nell'estrusione di profili in alluminio, che comprende anche R.C. Srl specializzata nelle lavorazioni meccaniche su alluminio. Questo passaggio importante ha permesso a K39 Srl di portare avanti numerosi nuovi progetti che vedranno la luce nei prossimi mesi oltre a potersi avvalere, come unico player del settore accessori, ad una produzione "interna" di profilati di alluminio, garanzia quindi di un costante approvvigionamento di materiale direttamente dal produttore. L'azienda è operativa sia sul mercato nazionale che su quello europeo grazie ad una rete di funzionari di Vendita e di distributori.

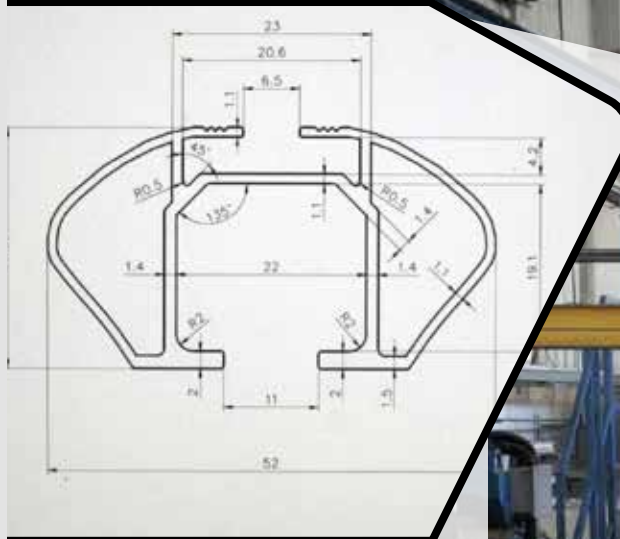

K39

carpa



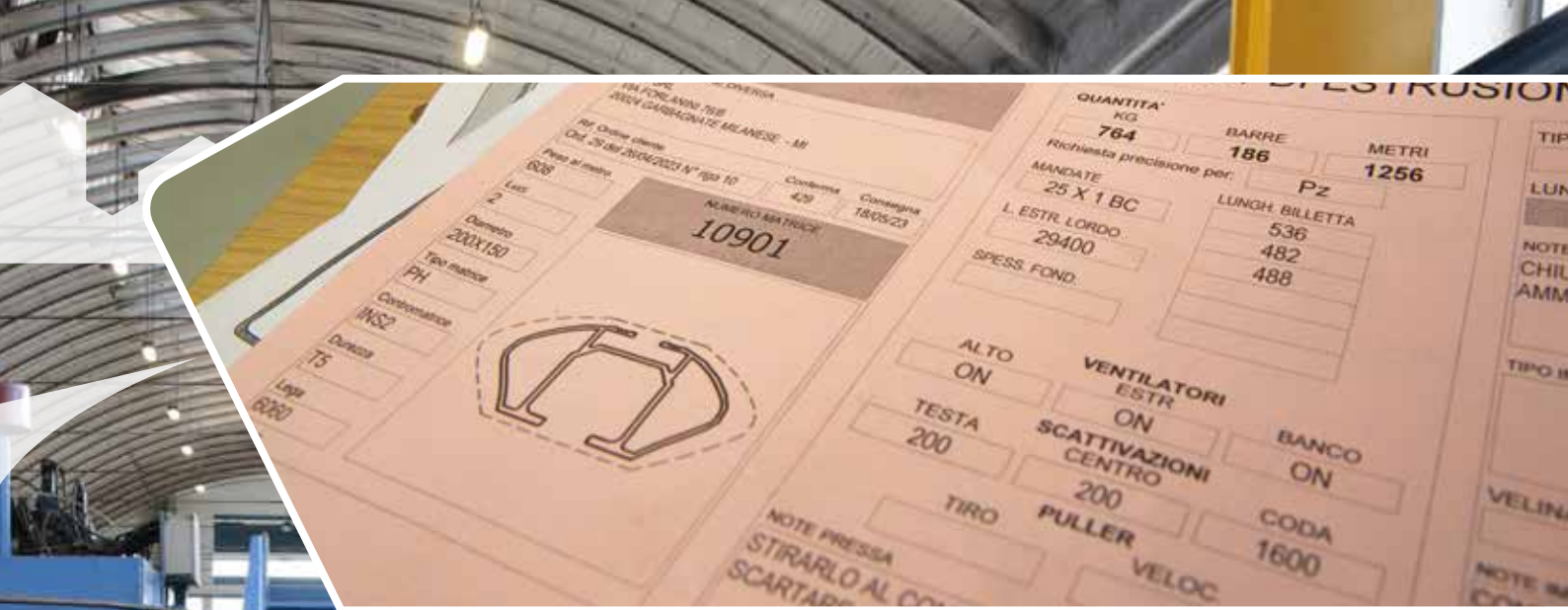

9
rts



K39
carparts



OUR COMPANY

K39 Srl is a young company based in the immediate Milan hinterland, in Garbagnate Milanese.

Founded in 2016, the company starts from an important pedigree in the car accessories sector. The founders come from companies producing and marketing accessories and spare parts with decades of experience.

The company manufactures and sells roof bars, bike racks and ski racks.

The construction of shearing molds and plastic injection molds for the production of its own articles takes place entirely within K39 SRL thanks to a CNC department.

Recently K39 Srl became part of the industrial group headed by Profilati Alluminio Srl, historic Italian company active in the extrusion of aluminum profiles, which also includes R.C. srl specialized in mechanical processing of aluminium. This important step allowed K39 Srl to carry out various new projects that will see the light in the coming months as well as be able to avail itself, as the only player in the car accessories sector, of an own production of aluminium profiles, therefore guaranteeing a constant supply of material directly from the producer.

The company operates on both national and European markets thanks to a network of official Sales points and distributors.







BARRE PORTATUTTO
per auto senza railings

ROOF BARS
for cars without railings

PRODOTTI
PRODUCTS



K1
K1 MEDIUM
K1 PRO
K1 PRO ALU
K1 VENTO

K1



MADE IN
ITALY

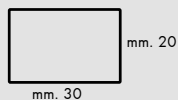

MAX 55/75 KG



ART. BS112 - M. 112

ART. BS130 - CM. 130

ART. BS150 - CM. 150



K1 MEDIUM



MADE IN
ITALY

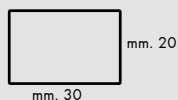

MAX 55/75 KG



ART. BSM112 - M. 112

ART. BSM130 - CM. 130

ART. BSM150 - CM. 150



K1 PRO



MADE IN
ITALY

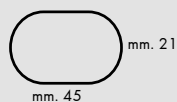

MAX 55/75 KG



ART. BSP112 - M. 112

ART. BSP130 - CM. 130

ART. BSP150 - CM. 150



K1 PRO ALU



MADE IN
ITALY

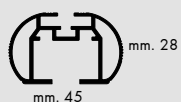

MAX 55/75 KG



ART. BAP112 - M. 112

ART. BAP30 - CM. 130

ART. BAP50 - CM. 150



K1 VENTO



MADE IN
ITALY



MAX 55/75 KG



ART. BAV112 - M. 112

ART. BAV130 - CM. 130

ART. BAV150 - CM. 150

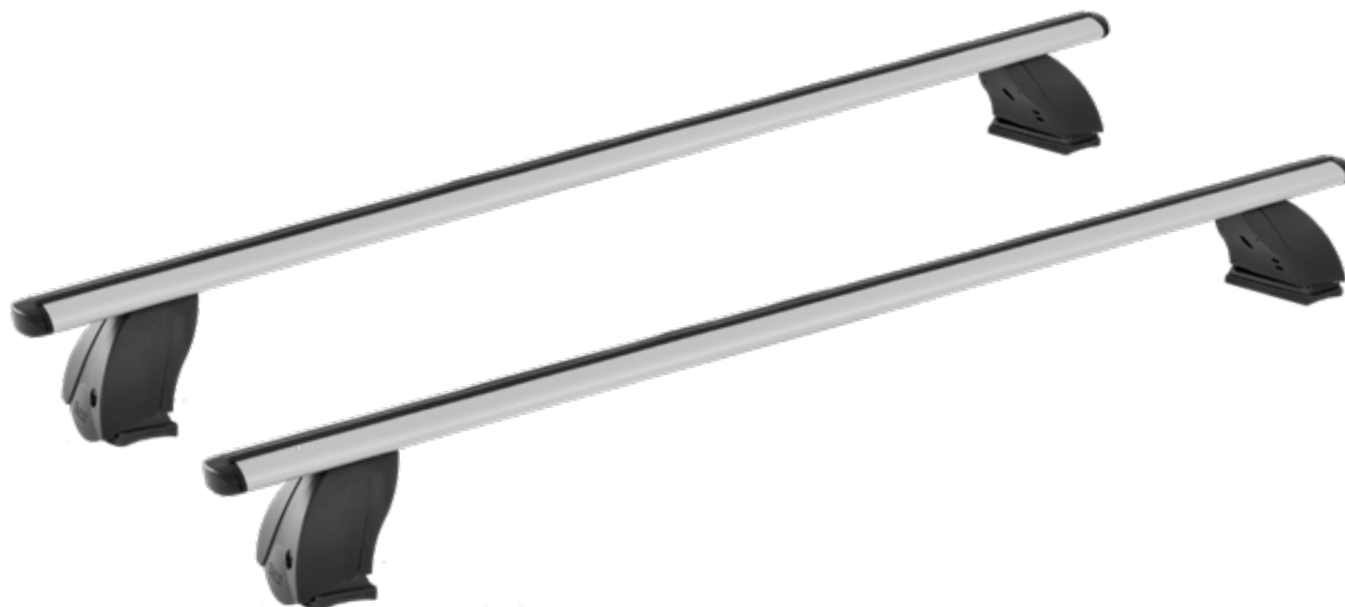

KIT DI FISSAGGIO FASTENING KIT

MOD. K  55 KG



PER:	KI
	KI MEDIUM
	KI PRO
FOR:	KI PRO ALU
	KI VENTO

KIT DI FISSAGGIO FASTENING KIT

MOD. KFP  75 KG



PER:	KI
	KI MEDIUM
	KI PRO
FOR:	KI PRO ALU
	KI VENTO

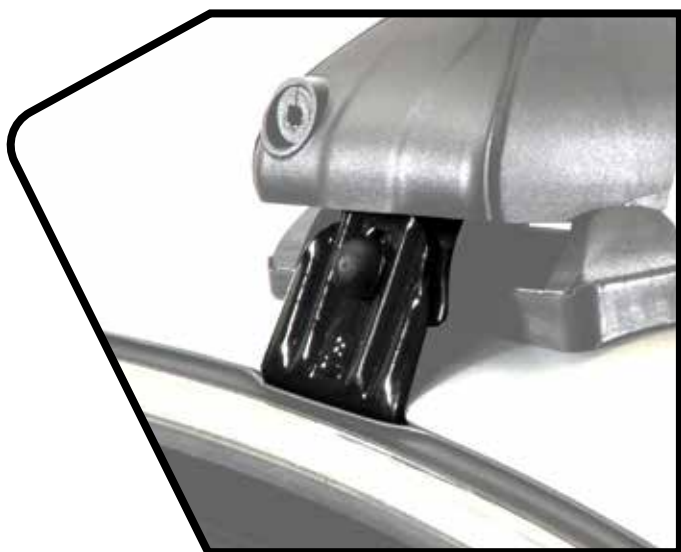

OPTIONAL

PER:	KI
	KI MEDIUM
	KI PRO
FOR:	KI PRO ALU
	KI VENTO



ART. K100B

PER:	KI
	KI MEDIUM
FOR:	KI PRO
	KI PRO ALU



ART. K101L



K39
carparts



BARRE PORTATUTTO

per auto con railings

ROOF BARS

for cars with railings

PRODOTTI
PRODUCTS



Aperto:
Open:
RAPID
LION
SIOPE

Integrato:
Flush:
KING
ZEFIRO

RAPID

RAILING APERTO
RAILING OPEN



DESIGNED IN
ITALY

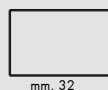

mm. 22

mm. 32



60/90 KG



ART. 831 - CM. 85-135

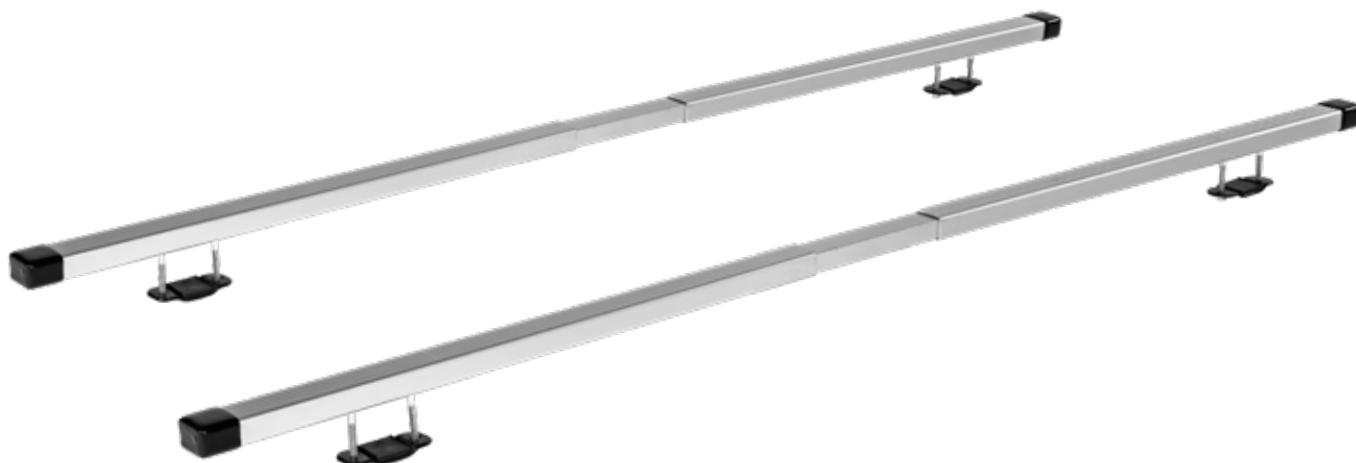

LION

RAILING APERTO
RAILING OPEN



MADE IN
ITALY



mm. 28

mm. 52



75 KG



ART. 801 - CM. 120

ART. 802 - CM. 135



SIOPE

RAILING APERTO
RAILING OPEN



MADE IN
ITALY



75 KG



ART. 851 - CM. 120

ART. 852 - CM. 135



KING



MADE IN
ITALY



75 KG



ART. 821 - CM. 112

ART. 822 - CM. 120



ZEFIRO



MADE IN
ITALY

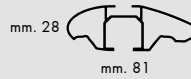

75 KG



ART. 841 - CM. 112

ART. 842 - CM. 120



OPTIONAL

PER:	LION
FOR:	KING

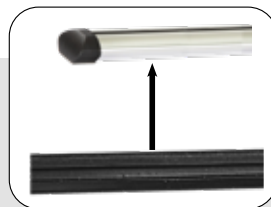

ART. 800G



PORTABICI BIKE CARRIER

PRODOTTI
PRODUCTS



Posteriore:

TRAVEL
HOLIDAY
MAK 3

Da gancio
traino:

JUPITER
ETRA

Da tetto:

ORION
SAGITTAR

TRAVEL



DESIGNED IN
ITALY



 X 3

 45 KG



A: min mm. 22
A: max mm. 45



A: min mm. 35
A: max mm. 60

ART. 401



HOLIDAY



DESIGNED IN
ITALY



 X 3

 45 KG



A: min mm. 22
A: max mm. 45



A: min mm. 35
A: max mm. 60

ART. 402



MAK 3



DESIGNED IN ITALY



 X 3

 45 KG



 A: min mm. 20
A: max mm. 50

 A: min mm. 50
A: max mm. 70

 A: max mm. 51

ART. 403



JUPITER



DESIGNED IN
ITALY



 X 3

 45 KG



ART. 501



ETRA



DESIGNED IN
ITALY



 X 2

 60 KG



ART. 502



E-BIKE



ORION



DESIGNED IN
ITALY



15 KG



A: min mm. 15
A: max mm. 65



A: max mm. 60
B: max mm. 100



A: max mm. 55

ART. 301



SAGITTAR



DESIGNED IN
ITALY



15 KG



X 2



A: min mm. 15
A: max mm. 65



A: max mm. 60
B: max mm. 100



A: max mm. 51

ART. 302



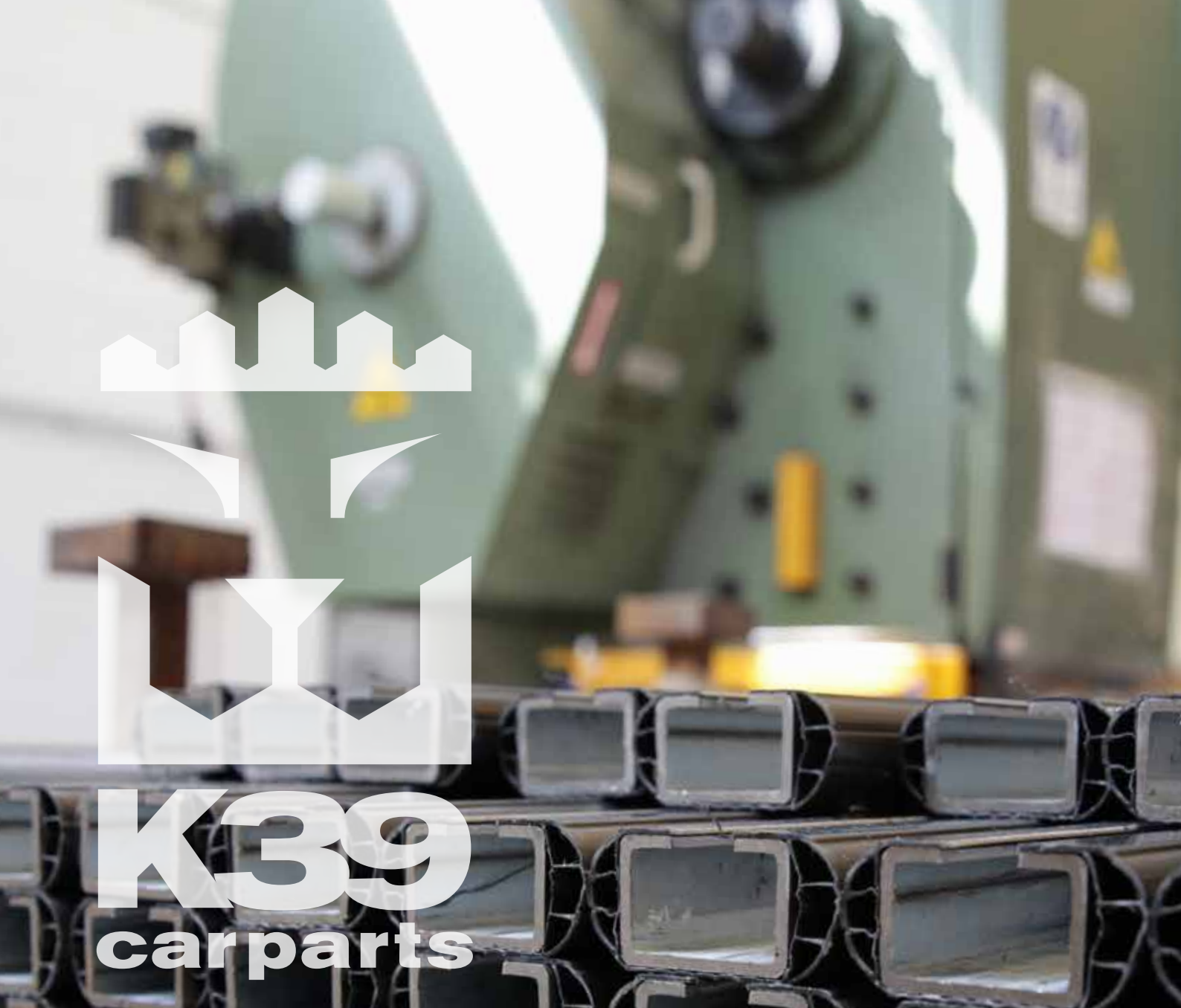

K39

carparts





PORTASCI SKI RACK

PRODOTTI
PRODUCTS



EVEREST 3
EVEREST 5
TRIVOR 5 SLIDE

EVEREST 3



DESIGNED IN
ITALY

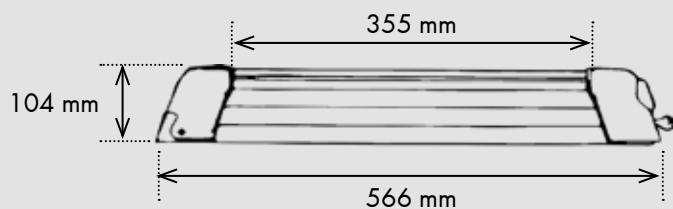

ART. 601



EVEREST 5



DESIGNED IN
ITALY

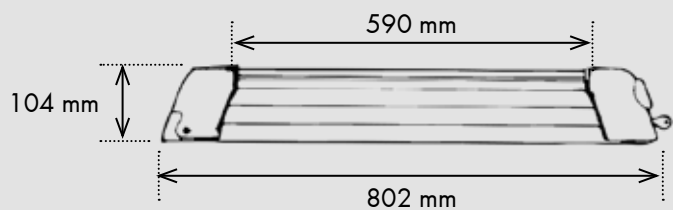

ART. 602



TRIVOR 5 SLIDE



DESIGNED IN
ITALY

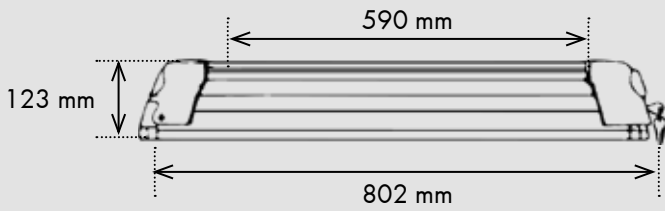

ART. 603



OPTIONAL

PER:	EVEREST 3
FOR:	EVEREST 5
	TRIVOR 5 SLIDE

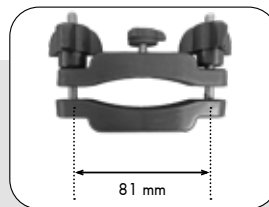

ART. 610



K39

carparts





BOX DA TETTO

ROOF BOX

PRODOTTI
PRODUCTS



COMETA 330

COMETA 330



MADE IN ITALY



50 KG



ART. 701 - BLACK

ART. 702 - BLACK MATT



Dimensioni esterne - External dimensions: 1410 mm
Dimensioni interne - Internal dimensions: 1330 mm

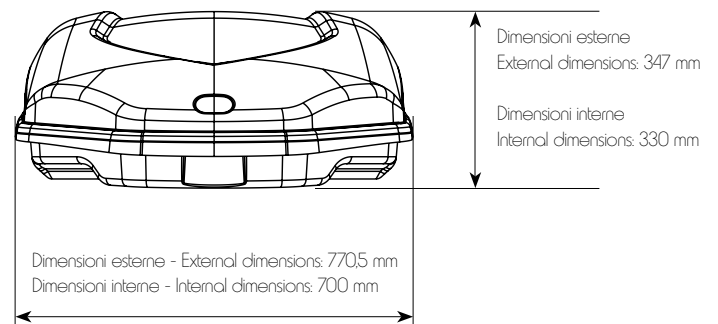
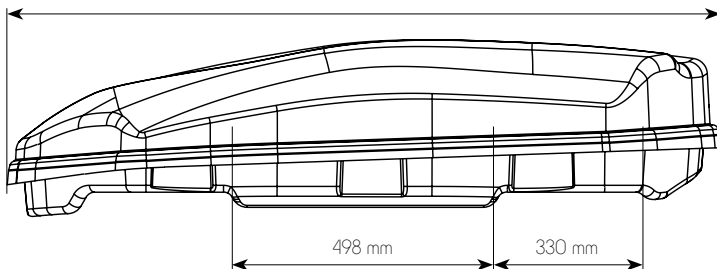

Peso prodotto Product weight	8KG	
Materiale Material	ABS	
Sistema di montaggio alle barre Fixing system to the roof bars		INCLUSO / INCLUDED (LXH) MAX 60X35MM
Sistema di montaggio alle barre Fixing system to the roof bars		OPTIONAL KIT ART. 14.01 T-SYSTEM X: MIN 8,5MM W: 13/20MM
Sistema di montaggio alle barre Fixing system to the roof bars		OPTIONAL KIT ART. 14.02 (LXH) MAX 80X35MM



BARRE PORTATUTTO
per veicoli professionali

ROOF BARS
for commercial vehicles

PRODOTTI
PRODUCTS



CARGO BAR
CARGO BAR ALU
KIT CARGO BAR

CARGO BAR

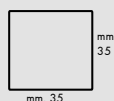

MAX 200 KG



ART. 260 - CM. 125	ART. 261 - CM. 135	ART. 262 - CM. 145
	ART. 263 - CM. 165	ART. 264 - CM. 175



CARGO BAR ALU

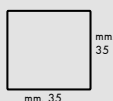

MAX 200 KG



ART. 270 - CM. 125	ART. 271 - CM. 135	ART. 272 - CM. 145
	ART. 273 - CM. 165	ART. 274 - CM. 175



KIT CARGO BAR



PER:	CARGO BAR
FOR:	CARGO BAR ALU



OPTIONAL CARGO SPOILER

ART. 280 - CM. 90

ART. 281 - CM. 120



CARGO FERMA SCALE CARGO LADDER FASTENING

ART. 282 - 2 PCS



CARGO RULLO + SUPPORTO CARGO ROLLER + SUPPORT

ART. 283 - CM. 60

ART. 284 - CM. 90



K39 S.r.l.

Tel +39 02.50309218

e-mail: info@k39.it

C.F. e P.I. 13970771005

Via Carlo Forlanini, 76B-C
20024 Garbagnate Milanese (MI)
ITALY

www.k39.it



ENJOY YOUR FREE TIME