

# CHRONO



USER MANUAL

PAUL HEWITT  
ANCHORED TO THE OCEAN

ENGLISH

<b>CONTENT</b>	<b>PAGE</b>
1. materials and technology	<b>4</b>
1.1 MARINIUM® Ocean Steel	4
1.2 Solar movements	4
1.3 Sapphire crystal	5
2. operating elements and functions	<b>6</b>
2.1 Start/stop function	7
2.2 Size adjustment mesh bracelet	8
2.3 Changing watch strap	9
2.4 Charging control display	10
2.5 Charging times	11
2.6 Water resistance	12
3. general information	<b>13</b>
3.1 Technical data	13
3.2 Operational readiness	14
3.3 Disposal	14

# 1. materials and technology

## 1.1 MARINIUM® OCEAN STEEL

Introducing MARINIUM® Ocean Steel, our own stainless steel that is fully recycled and meets the highest quality standards (304L and 316L surgical steel). MARINIUM® reduces the CO2 emissions of our products by more than 60% and is therefore an important factor in reducing our carbon footprint. The metallic components are primarily made of MARINIUM® Ocean Steel.

## 1.2 SOLAR MOVEMENTS

The sun - the energy that powers our world and, in the future, all PAUL HEWITT watches. Enduring, virtually inexhaustible and, above all, precise. In the future, our watches will need nothing but a natural or artificial light source to tell you the time. The solar cell in the dial converts the incident light into the required energy. And if there is no light available? No problem because our clocks run and run and run. With up to 6 months of dark power reserve, no adventure will stop you.

## 1.3 SAPPHIRE CRYSTAL

Only super scratch-resistant sapphire crystal is considered as protection for our watches. This will allow your watch to look like the first day for years to come and accompany you on all your adventures.

## 2. operating elements and functions

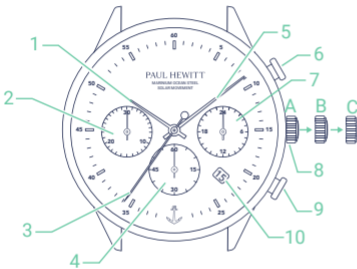

- 1 Hour hand
- 2 Stop minute
- 3 Second hand
- 4 Stop second
- 5 Minute hand
- 6 Start/stop pusher
- 7 24h display
- 8 Crown
- 9 Reset pusher
- 10 Date display

### SETTING THE TIME

Release the crown and pull it to position C. This stops the movement. Now you can set the time by rotating the crown. To reactivate the movement, push the crown back in the direction of the case.

## SETTING THE DATE

Pull the crown to position B. You can set the date by turning the crown counterclockwise. If the month has less than 31 days, set the date manually to the first day of the following month.

### 2.1 START/STOP FUNCTION

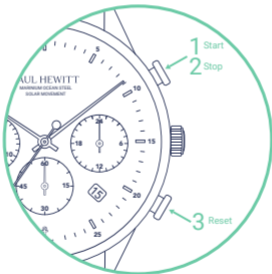

Press the start/stop pusher to start or stop the chrono's stopwatch (1)(2). Press the reset pusher to return the hands of the watch to their initial position (3).

## 2.2 SIZE ADJUSTMENT MESH BRACELET

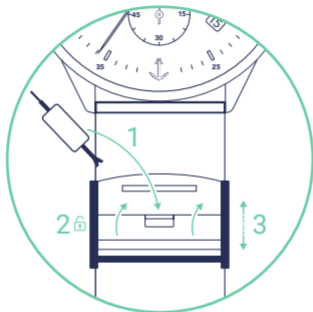

Insert a tool or another narrow object into the opening (1) of the slider. Release the locking mechanism (2) with a slight lever movement. You can then easily adjust the slider to the preferred size (3) and then lock it again (2).



## 2.3 CHANGING WATCH STRAP

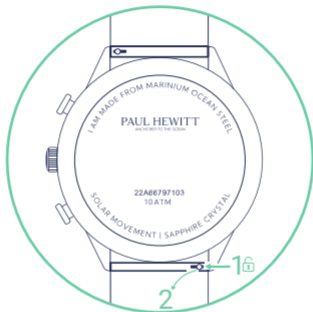

Press the bracelet lock inwards to unlock (1) and simultaneously move the bracelet away from the watch (2). Interchangeable bracelets can then be reattached in reverse order.



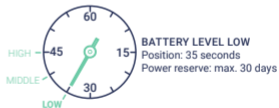
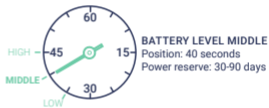
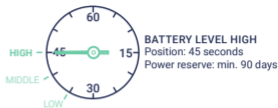

## 2.4 CHARGING CONTROL DISPLAY



To display the battery charge level of your solar watch, press the reset button and hold it for two seconds. The hand of the stop second (2) will then show you the current charge level.

## 2.5 CHARGING TIMES

For normal operation, it is completely sufficient if you wear your solar watch in everyday life and it charges itself through the different light sources. The following chart shows you the different charging times for our solar watches. These charging times depend on the intensity of the light source. The data are approximate values.

SOURCE OF LIGHT	ENVIRONMENT	TIME TO CHARGE FOR DAILY USE	TIME REQUIRED FOR STEADY OPERATION	TIME REQUIRED FOR FULL CHARGE
	Direct sunlight	2 minutes	30 minutes	5 hours
	Cloudy	5 minutes	1,5 hours	16 hours
	Direct fluorescent lighting	15 minutes	4 hours	52 hours
	Fluorescent lighting (indoors)	69 minutes	18 hours	-
	Without a source of light	The VR42 solar movement can run with a fully charged battery for 4 months without being further charged by light sources (dark power reserve)		

## 2.6 WATER RESISTANCE

The following chart shows which activities are possible without damaging your watch. Operating the crown on the watch can affect the water resistance, because the crown only provides protection when it is screwed on tightly or when it sits on the case. Activating the pushers of a chronograph under water can influence the water resistance, as water can enter the case in this way. **Very important: crown and pushers should not be used under water.**

MARKING	WASHING, RAIN, SPLASHES	SHOWER	SWIMMING	DIVING *
5 ATM	YES	NO	NO	NO
10 ATM	YES	YES	YES	NO
20 ATM	YES	YES	YES	YES

\*without equipment

### 3. general information

External influences can affect the water resistance of your watch, which may allow moisture to enter. Therefore, we recommend that you have your watch serviced on a regular basis. Other service operations or bracelet repairs should also be done by a professional. Your watch is equipped with a quality strap that has been tested several times by us. However, if you need to change your bracelet, please use a bracelet of the same quality, preferably an original PAUL HEWITT watch bracelet. Watch and bracelet can be cleaned with a dry or slightly damp cloth. Attention: Do not use any chemical cleaning agents (e.g. benzine or paint thinner). This can cause severe damage to the surface.

#### 3.1 TECHNICAL DATA

EPSON calibre cal. VR42B

Quarz solar movement

Dark power reserve up to 4 months

Operating temperature -5° to +50° C

10 ATM water resistance

## 3.2 OPERATIONAL READINESS

To keep your solar watch running, you should keep it in a place that is as bright as possible. Please make sure that the solar dial is not permanently covered by clothing, as this may reduce the operability of your watch. If the energy storage is discharged, keep your watch in bright light for a quick recharge. The charging time of your solar watch depends on the intensity of the light source and the design of the solar dial. The guide data given in the chart (p. 11) can be used as an orientation.

Important: Do not hold your solar watch too close to light sources that are too warm! Do not leave your watch in direct sunlight for a longer period of time! Temperatures above 50° C can damage the watch!

## 3.3 DISPOSAL

The crossed-out wheeled garbage can symbol is a reminder that electronic equipment, batteries and accumulators should not be disposed of in household waste. If you cannot reuse or recycle your item, it should be disposed of at a recycling facility or returned to us at your own costs.

Updated version: 10/2022  
Subject to alterations



PAUL HEWITT GmbH

Heiligengeistwall 12  
26122 Oldenburg, Germany

Phone +49 441 379 48 930  
Mail [shop@paul-hewitt.com](mailto:shop@paul-hewitt.com)

[www.paul-hewitt.com](http://www.paul-hewitt.com)

PAUL HEWITT  
ANCHORED TO THE OCEAN