

UV OZONE CLEANER USER MANUAL

Manual Version: 2.0.E

Product Code: L2002A2

Product Version: 2.0

Software Version: 2.0

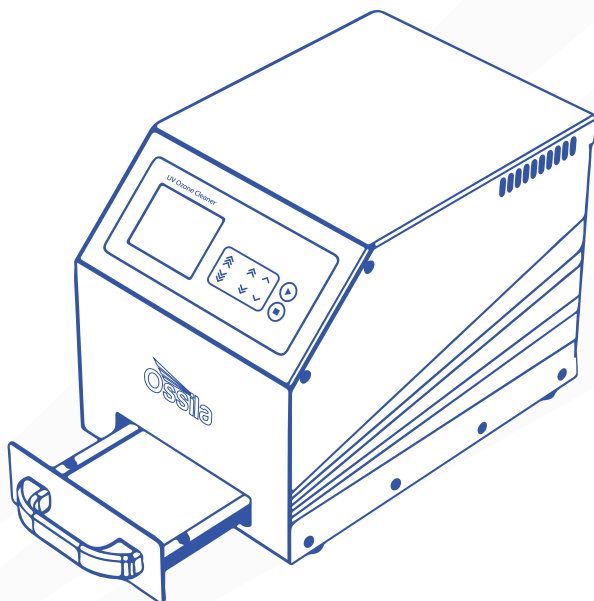

Contents

1. Overview	4
1.1 Applications	4
1.2 Contaminants	4
2. EU Declaration of Conformity (DoC)	5
3. Safety	8
3.1 Warning	8
3.2 Use of Equipment	8
3.3 Hazard Icons	8
3.4 General Hazards	9
3.5 Power Cord Safety	10
3.6 Servicing	10
3.7 Health and Safety – Installation	10
3.8 Health and Safety – Operation	10
3.9 Health and Safety – Servicing	11
4. Unpacking	11
4.1 Packing List	11
4.2 Damage Inspection	11
5. Specifications	12
6. System Components	12
7. Installation	13
8. Operation	14
8.1 Overview	14
8.2 User Interface	15
8.3 Practical Operation	15
8.4 Program Operation	16
8.5 Operational Safety	19
9. Maintenance	20
9.1 Cleaning	20
9.2 Repair and Service	21
9.3 Storage Conditions	21
10. Troubleshooting	21
11. Related products	22
11.1 Compatible Substrates	22
11.2 Related Equipment	22

1. Overview

The UV Ozone Cleaner is part of the Institute of Physics award-winning Solar Cell Prototyping Platform*. It provides a simple, inexpensive, and efficient method of obtaining ultra-clean surfaces free of organic contaminants. The UV Ozone Cleaner can clean a wide range of substrates, such as quartz, silicon, gold, nickel, aluminium, gallium arsenide, alumina, and glass slides.

The UV ozone cleaning process can produce an atomically-clean surface in only a few minutes. However, the substrate surface must be nominally clean beforehand. The cleaning rate of UV ozone using atmospheric oxygen at ambient conditions depends on the nature of the contaminant molecules, but is typically of the order of 0.1 - 1.0 Å/s. The exact exposure times and methods required to remove various contaminants will vary and should be determined empirically.

*The Ossila Solar Cell Prototyping Platform is a complementary collection of substrates, materials, and equipment as part of a high-performance standard photovoltaic reference architecture. This platform enables researchers to produce high-quality, fully-functional solar cells which can be used as a reliable baseline.

For more information: ossila.com/pages/solar-cell-prototyping-platform

1.1 Applications

- Improving surface hydrophilicity
- Surface cleaning
- Preparation for thin-film deposition and surface treatment
- Ultraviolet curing
- Surface sterilization
- Removal of surface monolayers
- Surface oxidation

1.2 Contaminants

- Photoresist
- Resins
- Human skin oils
- Cleaning solvent residues
- Plastic surface/silicon oil residues
- Solder flux

2. EU Declaration of Conformity (DoC)

We

Company Name: Ossila Limited
Postal Address: Solpro Business Park, Windsor Street.
Postcode: S4 7WB
City: Sheffield
Telephone number: +44 (0)114 2999 180
Email Address: info@ossila.com

declare that the DoC is issued under our sole responsibility and belongs to the following product:

Product: UV Ozone Cleaner (L2002A2)
Serial number: L2002A-2000-2000-2000- xxxx
Object of declaration:
UV Ozone Cleaner (L2002A2)

The object of declaration described above is in conformity with the relevant Union harmonisation legislation:

Low Voltage Directive 2014/35/EU
EMC Directive 2014/30/EU
RoHS Directive 2011/65/EU

The following harmonised standards and technical specifications have been applied:

BS EN 61010-1:2010 Safety requirements for electrical equipment for measurement, control, and laboratory use.

Signed:



Name: Dr James Kingsley
Place: Sheffield
Date: 01/02/2018

[Декларация] за съответствие на ЕС

Производител: Ossila Ltd., Solpro Business Park, Windsor Street, S4 7WD, Великобритания

Декларира с цялата си отговорност, че посоченото оборудване съответства на приложимото законодателство на ЕС за хармонизиране, посочено на предходната(-ите) страница(-и) на настоящия документ.

[Čeština] Prohlášení o shodě EU

Výrobce: Ossila Ltd., Solpro Business Park, Windsor Street, S4 7WD, Spojené Království

Prohlášíme na vlastní odpovědnost, že uvedené zařízení je v souladu s příslušnými harmonizačními předpisy EU uvedenými na předchozích stranách tohoto dokumentu.

[Dansk] EU-overensstemme I seserklæring

Producent: Ossila Ltd., Solpro Business Park, Windsor Street, S4 7WD, UK

Erklærer herved, at vi alene er ansvarlige for, at det nævnte udstyr er i overensstemmelse med den relevante EU-harmoniseringslovgivning, der er anført på den/de foregående side(r) i dette dokument.

[Deutsch] EU-Konformitätserklärung

Hersteller: Ossila Ltd., Solpro Business Park, Windsor Street, S4 7WD, Vereinigtes Königreich

Wir erklären in alleiniger Verantwortung, dass das aufgeführte Gerät konform mit der relevanten EU-Harmonisierungsgesetzgebung auf den vorangegangenen Seiten dieses Dokuments ist.

[Eesti keel] Eli vastavusavaldus

Tootja: Ossila Ltd., Solpro Business Park, Windsor Street, S4 7WD, UK

Kinnitame oma ainuvastutuse, et loetletud seadmed on kooskõlas antud dokumendi eelmisel leheküljel / eelmistel lehekülgedel ära toodud asjaomaste ELi ühtlustamise õigusaktidega.

[Ελληνικά] Δήλωση πιστότητας ΕΕ

Κατασκευαστής: Ossila Ltd., Solpro Business Park, Windsor Street, S4 7WD, Ηνωμένο Βασίλειο

Δηλώνουμε υπεύθυνα ότι ο αναφερόμενος εξοπλισμός συμμορφώνεται με τη σχετική νομοθεσία εναρμόνισης της ΕΕ που υπάρχει στις προηγούμενες σελίδες του παρόντος εγγράφου.

[Español] Declaración de conformidad UE

Fabricante: Ossila Ltd., Solpro Business Park, Windsor Street, S4 7WD, Reino Unido

Declaramos bajo nuestra única responsabilidad que el siguiente producto se ajusta a la pertinente legislación de armonización de la UE enumerada en las páginas anteriores de este documento.

[Français] Déclaration de conformité UE

Fabricant: Ossila Ltd., Solpro Business Park, Windsor Street, S4 7WD, Royaume-Uni

Déclarons sous notre seule responsabilité que le matériel mentionné est conforme à la législation en vigueur de l'UE présentée sur la/ les page(s) précédente(s) de ce document.

[Hrvatski] E.U izjava o sukladnosti

Proizvođač: Ossila Ltd., Solpro Business Park, Windsor Street, S4 7WD, Velika Britanija

Izjavljujemo na vlastitu odgovornost da je navedena oprema sukladna s mjerodavnim zakonodavstvom EU-a o usklađivanju koje je navedeno na prethodnoj(nim) stranici(ama) ovoga dokumenta.

[Italiano] Dichiarazione di conformità UE

Produttore: Ossila Ltd., Solpro Business Park, Windsor Street, S4 7WD, UK

Si dichiara sotto la propria personale responsabilità che l'apparecchiatura in elenco è conforme alla normativa di armonizzazione UE rilevante indicata nelle pagine precedenti del presente documento.

[Latviešu] ES atbilstības deklarācija

Ražotājs: Ossila Ltd., Solpro Business Park, Windsor Street, S4 7WD, UK

Ar pilnu atbildību paziņojam, ka uzskaitītais aprīkojums atbilst attiecīgajiem ES saskaņošanas tiesību aktiem, kas minēti iepriekšējās šī dokumenta lapās.

[Lietuvių k.]**ES atitikties deklaracija**

Gamintojas: Ossila Ltd., Solpro Business Park, Windsor Street, S4 7WD, UK

atsakingai pareiškia, kad išvardinta įranga atitinka aktualius ES harmonizavimo teisės aktus, nurodytus ankstesniuose šio dokumento

[Magyar]**EU-s megfeleléségi nyilatkozat**

Gyártó: Ossila Ltd., Solpro Business Park, Windsor Street, S4 7WD, UK

Kizárólagos felelősségünk mellett kijelentjük, hogy a felsorolt eszköz megfelel az ezen dokumentum előző oldalán/oldalain található EU-s összehangolt jogszabályokra vonatkozó rendelkezéseinek.

[Nederlands]**EU-Conformiteitsverklaring**

Fabrikant: Ossila Ltd., Solpro Business Park, Windsor Street, S4 7WD, UK

Verklaart onder onze uitsluitende verantwoordelijkheid dat de vermelde apparatuur in overeenstemming is met de relevante harmonisatiewetgeving van de EU op de vorige pagina(s) van dit document.

[Norsk]**EU-samsvarserklæring**

Produsent: Ossila Ltd., Solpro Business Park, Windsor Street, S4 7WD, UK

Erklærer under vårt enansvar at utstyret oppført er i overholdelse med relevant EU-harmoniseringslovverk som står på de(n) forrige siden(e) i dette dokumentet.

[Polski]**Deklaracja zgodności Unii Europejskiej**

Producent: Ossila Ltd., Solpro Business Park, Windsor Street, S4 7WD, UK

Oświadczamy na własną odpowiedzialność, że podane urządzenie jest zgodne ze stosownymi przepisami harmonizacyjnymi Unii Europejskiej, które przedstawiono na poprzednich stronach niniejszego dokumentu.

[Por tuguês]**Declaração de Conformidade UE**

Fabricante: Ossila Ltd., Solpro Business Park, Windsor Street, S4 7WD, Reino Unido

Declara sob sua exclusiva responsabilidade que o equipamento indicado está em conformidade com a legislação de harmonização relevante da UE mencionada na(s) página(s) anterior(es) deste documento.

[Română]**Declarație de conformitate UE**

Producător: Ossila Ltd., Solpro Business Park, Windsor Street, S4 7WD, Regatul Unit

Declară pe proprie răspundere că echipamentul prezentat este în conformitate cu prevederile legislației UE de armonizare aplicabile prezentate la pagina/paginile anterioare a/ale acestui document.

[Slovensky]**Vyhlasenie o zhode pre EÚ**

Výrobca: Ossila Ltd., Solpro Business Park, Windsor Street, S4 7WD, Spojené kráľovstvo

Na vlastnú zodpovednosť prehlasuje, že uvedené zariadenie je v súlade s príslušnými právnymi predpismi EÚ o harmonizácii uvedenými na predchádzajúcich stranách tohto dokumentu.

[Slovenščina]**Izjava EU o skladnosti**

Proizvajalec: Ossila Ltd., Solpro Business Park, Windsor Street, S4 7WD, UK

s polno odgovornostjo izjavlja, da je navedena oprema skladna z veljavno uskladitveno zakonodajo EU, navedeno na prejšnji strani/ prejšnjih straneh tega dokumenta.

[Suomi]**EU-vaatimusten mukaisuusvakuutus**

Valmistaja: Ossila Ltd., Solpro Business Park, Windsor Street, S4 7WD, UK

Vakuutamme täten olemme yksin vastuussa siitä, että tässä asiakirjassa luetellut laitteet ovat tämän asiakirjan sivuilla edellisillä sivuilla kuvattujen olennaisten yhdenmukaistamista koskevien EU-säädösten vaatimusten mukaisia.

[Svenska]**EU-försäkran om överensstämmelse**

Tillverkare: Ossila Ltd., Solpro Business Park, Windsor Street, S4 7WD, Storbritannien

Vi intygar härmed att den utrustning som förtecknas överensstämmer med relevanta förordningar gällande EU-harmonisering som finns på föregående sidor i detta dokument.

3. Safety

3.1 Warning

- Operate within fume cupboard in a room with suitable air ventilation at all times
- Only use the power cord (and transformer) supplied with the unit
- Mains inlet rated for 230V ± 10%. For 110V mains supplies, use the transformer supplied
- Do not cover the ventilation slots
- If the lamp breaks, leave the room ventilating for at least 15 minutes & contact Ossila
- The unit must be connected to a grounded power outlet

3.2 Use of Equipment

The UV Ozone Cleaner is designed to be used as instructed. It is intended to be operated in a laboratory environment under a fume cupboard/hood and is designed to be used in the following environmental conditions:



- Indoors in a laboratory environment (pollution degree 2)
- Altitudes up to 2000 m
- Temperatures of 5°C to 40°C; maximum relative humidity of 80% up to 31°C.



The cleaner is supplied with a power cord (and if necessary an additional power transformer) for the country of purchase, in accordance with European Commission regulations and British Standards. Use of any other electrical power cables, adaptors, or transformers is not recommended.

3.3 Hazard Icons

The symbols shown in **Table 3.1** can be found at points throughout the manual. Note each warning before attempting any associated operations.

Table 3.1. Hazard warning labels used in this manual.

Symbol	Associated Hazard
	General warning or caution, which accompanying text will explain
	Electrical shock
	Severe injury or death by electrical shock

	UV radiation
	Ozone inhalation
	Explosion

3.4 General Hazards

Before installing or operating the UV Ozone Cleaner, there are several health and safety precautions which must be followed and executed to ensure safe installation and operation.

WARNING: Improper handling when operating or servicing this equipment can result in serious injury. Read this manual before operating or servicing this equipment.



- I. DANGER: DO NOT use the UV Ozone Cleaner in the presence of an explosive atmosphere.



- II. WARNING: To avoid electrical shock or injury, do not remove tray or try to access any internal parts. Servicing should only be carried out by a trained professional. Before servicing, disconnect the power cord and wait 10 minutes (high voltage may persist in capacitors for some time after removal of power).



- III. CAUTION: The UV Ozone Cleaner uses a ground-type power plug, which must be connected to a grounded outlet to prevent electrical shock. The UV Ozone Cleaning unit will be supplied with an earthed plug appropriate for the country of purchase.



- IV. The UV lamp is a mercury vapour lamp. The user may be exposed to mercury if the lamp glass breaks. If this happens, please abide by the following rules to minimise exposure:
- Ensure the power is disconnected to avoid the risk of electrocution.
 - Store the container and UV Ozone Cleaner in a fume hood and leave the room under ventilation for at least 15 minutes.
 - Using cut-resistant gloves, collect any stray pieces of glass in a sealed container. Dispose of the glass at a suitable collection point.



- V. The UV Ozone Cleaner has a high voltage source. Do not attempt to open the unit.

3.5 Power Cord Safety



- I. Emergency power disconnect options: Use the power cord as a disconnecting method and remove it from the power source. To facilitate disconnect, make sure the power outlet for this cord is readily accessible to the operator.



- II. Only use the power cord (and transformer if using 110 V mains supply) supplied with the UV Ozone Cleaner. Using an unearthed plug may result in serious injury or death.

3.6 Servicing

If servicing is required, please return the unit to Ossila Ltd. Any other action will void the warranty.

3.7 Health and Safety – Installation



- I. High-intensity, mercury vapour lamps can generate extreme heat and temperatures. Furthermore, ozone is a powerful oxidising agent and can react explosively with combustible materials. Keep flammable materials a minimum of three feet away from operating equipment.



- II. The UV Ozone Cleaner is intended for operation inside a fully-functioning fume hood or fume cupboard only. There is no ozone filtration system incorporated into the UV Ozone Cleaner.

3.8 Health and Safety – Operation



- I. UV radiation can cause severe burns to the eyes and skin. An integrated safety interlock prevents the lamp from being powered on whilst the tray is open. As a precaution, never look directly into the sample chamber when the UV ozone cleaner unit is powered on.



- II. Ozone is a highly reactive substance and can cause adverse health effects at the sites of initial contact: The respiratory tract, lungs — and at higher concentrations, the eyes. The principal health effects are caused by irritation or damage to the small airways of the lungs, and symptoms include coughing and a feeling of tightness in the chest. Uncontrolled exposure to high levels of ozone could lead to more severe health effects.



III. When operating the UV Ozone Cleaner, air flow in and around the unit must remain unobstructed to prevent the unit from overheating. If the temperature inside the sample chamber reaches above 65 °C, the unit will automatically switch off to prevent overheating. Allow the system to cool down to room temperature before resuming use.



IV. IMPORTANT NOTE: Excessive cooling will diminish the lamp's operating voltage and effectiveness, whereas inadequate cooling may cause damage to system components.



V. The UV Ozone Cleaner has a high voltage source. Do not attempt to open the unit.

3.9 Health and Safety – Servicing



I. Service or installation work that includes integrating electrical components should only be performed by an Ossila engineer. Never alter the wiring of any purchased equipment. If changes are made, such alterations may damage the equipment, cause injury, or even death. At the very least, such alterations will void your warranty.

4. Unpacking

4.1 Packing List

The standard items included with the UV Ozone Cleaner are:

- UV Ozone Cleaner unit
- Power cord set (specific for country of operation)
- User manual

4.2 Damage Inspection

Examine the components for evidence of shipping damage. If damage has occurred, please contact Ossila directly for further action. The UV lamp is a mercury vapour lamp and the user may be exposed to mercury only if the glass of the lamp is cracked or broken. If this happens, please contact Ossila after abiding by these rules to minimise exposure:

1. Ensure the power is disconnected to avoid the risk of electrocution.
2. Store the container and UV Ozone Cleaner in a fume hood and leave the room under ventilation for at least 15 minutes.
3. Using cut-resistant gloves, collect any stray pieces of glass in a sealed container. Dispose of the glass at a suitable collection point.

5. Specifications

The UV Ozone Cleaner specifications are shown in **Table 5.1**

Table 5.1. UV Ozone Cleaner specifications.

UV Ozone Cleaner	Specifications
UV Lamp	Synthetic quartz 4 x 4 grid UV lamp
UV lamp key wavelengths	185 nm and 254 nm
Power supply	230V ± 10 %; 50/60Hz, 50 VA
Class of protection	Class I
Degree of protection	IP20
Maximum run time	59 minutes and 59 seconds
Safety features	Interlock; thermal cut-out
Unit dimensions	Width: 193 mm Height: 230 mm Depth: 300 mm
Tray dimensions	100 mm x 100 mm
Fuses	1 A slow blow
Weight	5 kg

6. System Components

The UV Ozone Cleaner comprises two items:

- UV Ozone Cleaner unit (**Figure 6.1**).
- Power supply cord (**Figure 6.2**). The UV Ozone Cleaner unit is powered by 230V, 50/60Hz supply, Countries with a 110V power supply are supplied with an additional power transformer.

Figure 6.1. UV Ozone Cleaner.

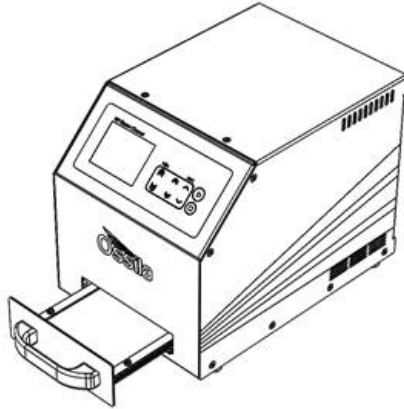
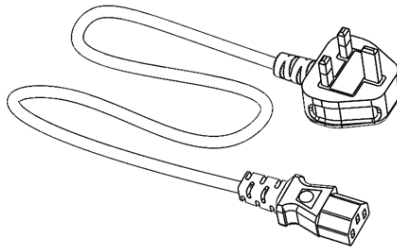

Figure 6.2. Main power cord adapter. The UV Ozone Cleaner ships with a suitable plug for the country of purchase.



7. Installation

1. Place the unit on a solid, level surface inside a fume cupboard.
 - i. Ensure the area is free from vibrations, temperature extremes and highly flammable or explosive materials.
2. Before plugging in the UV Ozone Cleaner, ensure the power switch on the unit is switched to the '0' position (off).
3. Connect the power cord to the UV Ozone Cleaner unit.
 - i. See **Figure 7.1** to see how to connect the UV Ozone Cleaner to the power supply cable.
4. Switch the UV Ozone Cleaner power switch to the 'I' position to turn on.

Figure 7.1. Plugging in the UV Ozone Cleaner power cord cable.

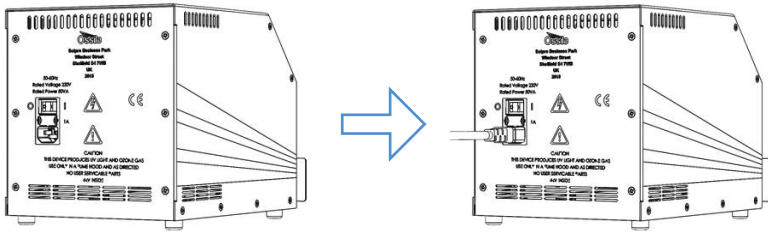

8. Operation

8.1 Overview

A top-down view of the UV Ozone Cleaner is shown in **Figure 8.1**, with all the relevant components highlighted. **Figure 8.2** shows the power cord socket, fuse socket, and the power switch.

Figure 8.1. Components of the UV Ozone Cleaner

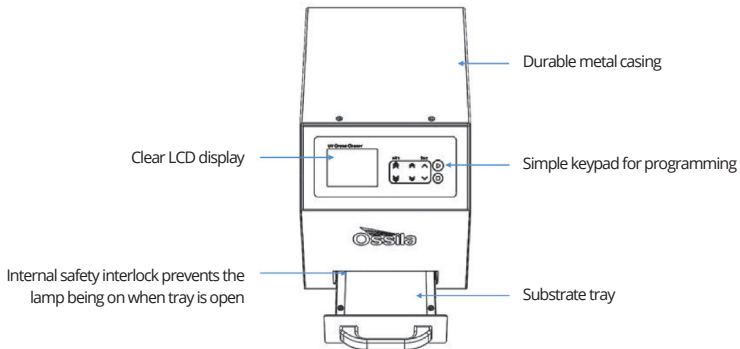
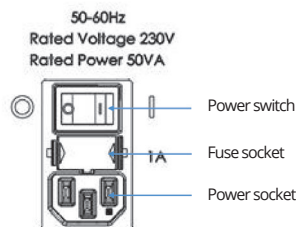

Figure 8.2 UV Ozone power switch, fuse socket, and power socket position on the back panel.



8.2 User Interface

Figure 8.3 shows the front panel of the UV Ozone Cleaner. The function of each of the keypad buttons is explained in **Table 8.1**.

Figure 8.3. UV Ozone Cleaner LCD screen and keypad.

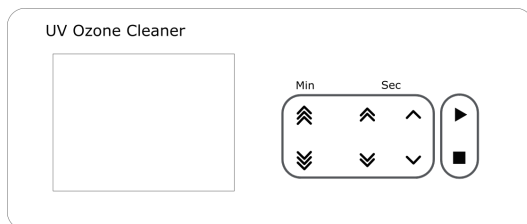

Table 8.1. Operational buttons and their associated functions.

Button		Function
START		Starts operation for the Set Time programmed
STOP		Terminates the running program and resets the Set Time to zero
MIN		Increase the set time by 1 minute
		Decrease the set time by 1 minute
SEC		Increase the set time by 10 seconds
		Decrease the set time by 10 seconds
		Increase the set time by 1 second
		Decrease the set time by 1 second

8.3 Practical Operation



Operate within fume cupboard in a room with suitable air ventilation at all times.



1. Open the tray door.
2. Carefully load your sample to be cleaned onto the tray.
 - I. The tray surface may become slippery with use of the UV Ozone Cleaner; take care to avoid your sample sliding off the surface.



- II. **WARNING:** Should your sample fall inside of the UV Ozone Cleaner unit, do not attempt to retrieve it. Doing so may result in damage to the unit or personal injury. The UV Ozone Cleaner can operate safely should small objects fall into the tray (providing the tray door can be fully closed).
3. Program the UV Ozone Cleaner with the desired **Set Time** and press the start button (see section below).
4. Once the program has finished, open the tray door and remove your sample.

8.4 Program Operation



WARNING! High voltage

The internal UV lamp can operate at a maximum of 4000 V. Make sure the unit is connected to a grounded power outlet. Ensure the area around the back of the unit is kept clear. It is good practice to keep any cables around the unit in a tidy manner. Avoid keeping any solvents around this piece of equipment.



WARNING! Ultraviolet light

The low-pressure mercury vapour grid lamp inside this equipment emits harmful UV radiation. Avoid exposure at all times. Avoid keeping any solvents around this piece of equipment.



WARNING! Inhalation hazard

Ozone is produced by this equipment during operation. Use only inside a fume cupboard and in an area where appropriate ventilation is available.

1. Turn the UV Ozone Cleaner power switch on (position 'I'); the bootup screen is shown **Figure 8.4**.

Figure 8.4. Bootup screen.



2. During the bootup time, the user can enter the buzzer setting and temperature reading menu screens for the UV Ozone Cleaner.

- I. Press and hold both **single-increment second buttons**  at the same time to see the temperature readings display as in **Figure 8.5**.

Figure 8.5. Temperature readings display.



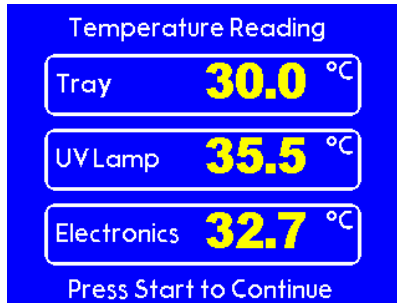

- II. Press and hold both **double-increment second buttons**  at the same time to enter the buzzer settings as in **Figure 8.6**.
- III. To change the buzzer settings, press the **single-increment up second button**  to turn the buzzer sound on, or the **single-increment down second button**  to turn the buzzer sound off.

Figure 8.6. Buzzer settings menu.



- 3. To exit the Settings page, press the **START** button to proceed to continue.
- 4. The user must read the caution message and press **START** to enter the main screen of the UV Ozone Cleaner as shown in **Figure 8.7**.

Figure 8.7. Caution screen

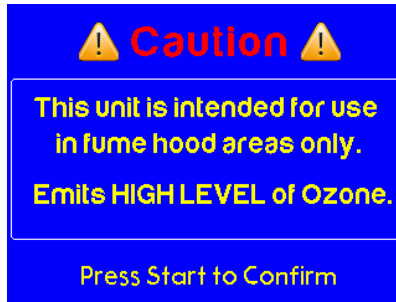

5. Modify the **Set Time** using the **Minute (MIN)** and **Second (SEC)** buttons on the keypad. The maximum value of the timer is 59 min 59 secs (as shown in **Figure 8.8**).

Figure 8.8 Set Time screen.

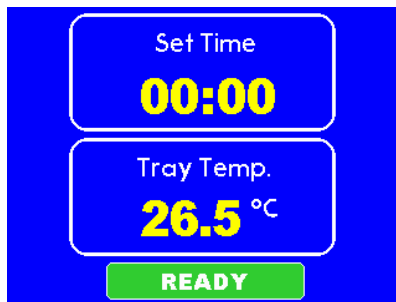

6. Once the timer has been set, press the **START** button to run the program. The LCD will display the following information (as shown in **Figure 8.9**).
 - I. The **Elapsed** timer will begin and the LED indicator light will switch on.
 - II. When the **Elapsed** time matches the **Set Time**, the one-note buzzer will sound — indicating the program has finished.
 - III. While the program is running, the user can stop the program by pressing the **STOP** button. This will also reset the **Set Time** to 00:00.

Figure 8.9. Run screen

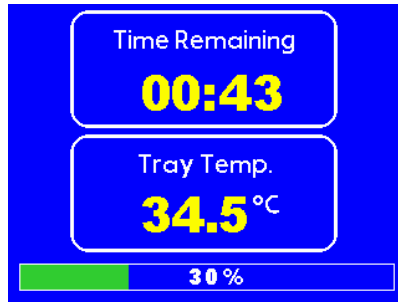

8.5 Operational Safety

(I) Safety Interlock

If the tray is opened while the system is running the program will automatically stop. Turn the lamp OFF and reset the **Set Time** to 00:00. The display will indicate **TRAY OPEN** (as shown in **Figure 8.10**).

Figure 8.10. TRAY OPEN warning.

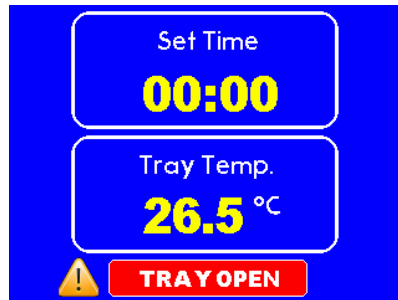

(II) High Temperature Safety Warning

If one or more of the internal temperature sensors reads above certain temperature value, a high temperature warning will appear on the screen. **Table 8.2** shows the different warnings for this unit for given temperatures. The error code that is displayed when the tray or electronics sensor exceeds 65 °C indicates which sensor is at a high temperature and is used for troubleshooting.

(III) Temperature Error

If one of the temperature sensors gives an error reading, a warning (as shown in **Figure 8.11**) will appear and the user is required to restart the unit. The error code that is displayed indicates which sensor is in error and is used for troubleshooting.

Table 8.2. High temperature warning.



Warning	Display
HIGH TEMP (if tray or electronics is > 50°C)	 The display shows a blue background with a white rounded rectangle at the top containing the text 'Set Time' and '00:00' in yellow. Below this is a red rounded rectangle containing 'Tray Temp.' and '55.0 °C' in yellow, flanked by two yellow warning triangles. At the bottom is a green rounded rectangle containing the word 'READY' in white.
VERY HIGH TEMP (if tray or electronics is > 65°C)	 The display shows a blue background with a central red rounded rectangle containing the text 'TEMP HIGH!' in white, '0x2' in white, and 'Please Turn OFF' in white.

Figure 8.11. Temperature error warning.

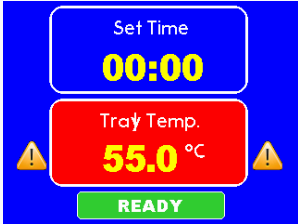

9. Maintenance

9.1 Cleaning

Maintenance consists of periodic cleaning. The exterior of the instrument can be cleaned with a clean, dry cloth to remove any oil, grease, or grime. Never use liquid solvents or detergents. Repairs or servicing not covered in this manual should only be performed by qualified personnel.

9.2 Repair and Service

There are no user-serviceable parts in this unit except for the fuse which is accessible externally. If the unit is faulty, return it to Ossila Limited. Our service department will promptly quote to repair any faults that occur outside the warranty period.

9.3 Storage Conditions

The UV Ozone Cleaner should be kept in dry conditions; away from direct sources of heat or sunlight, and in such a manner as to preserve the working life of the instrument.

10. Troubleshooting

Table 10.1. Troubleshooting guidelines for the Ossila UV Ozone Cleaner

Problem	Possible cause	Action
No power / display	<ul style="list-style-type: none">a. The power switch on the unit is in the OFF positionb. The power supply may not be connected properlyc. The fuse on the rear panel has blownd. If the unit was supplied with a transformer, it may be faultye. Fault on circuit board	<ul style="list-style-type: none">a. Check the connection and ensure the power is turned ONb. Ensure the unit is firmly plugged in to the power supply and the plug is firmly connected to both the power inlet and the power socketc. Ensure the unit is unplugged. Check the fuse on the rear panel. If it has blown, replace with a suitably rated 1A slow blow fused. Contact Ossila for a replacement transformere. If all the above causes have been considered, there may be a fault on the board. Please contact Ossila for information
Power but timer does not operate	The tray door has not been closed properly 'TRAY OPEN' will display	Ensure the tray door is fully closed. The drawer should hold firmly in position when this is the case.
Continuous buzzer	Error in temperature reading UV Ozone Cleaner temperature is extremely high	Check the temperature reading by entering the settings mode (referred to Section 8.4) If the temperature is extremely high, turn the unit OFF and allow sufficient time for it to cool down

11. Related products

11.1 Compatible Substrates

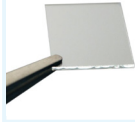

ITO Substrates

Our range of 15 x 20 mm ITO substrates for OPV, OLED and sensing applications.

Product codes: S111 / S101 / S211 / S281 / S171



Pre-patterned ITO OFET Substrates

Designed to enable fabrication and characterisation without the need for vacuum evaporations or probe stations.

Product codes: S161 / S162



Silicon Oxide OFET Substrates

Silicon substrates with thermal oxide layer pre-cut to fit the Ossila OFET fabrication systems.

Product code: S146

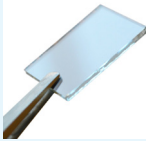

Synthetic Quartz Coated Substrates

Flat glass substrates coated with 20 nm of SiO₂ to help with surface wetting and prevent ion migration.

Product code: S151

11.2 Related Equipment



Spin Coater

Produce high-quality coatings without any substrate warping. Perfect for busy labs with limited space.

Product code: L2001A3



Syringe Pump

High-precision, programmable single and dual syringe pumps for the automatic dispensing of solutions.

Product codes: L2003S1 / L2003D1



Four-Point Probe Test System

Quick, easy, and accurate characterisation and sheet resistance measurements for various materials.

Product code: T2001A3



Source Measure Unit

Source voltage, measure current, get data. Simplify and accelerate your data collection!

Product code: P2005A2



THE QUEEN'S AWARDS
FOR ENTERPRISE:
INTERNATIONAL TRADE
2018

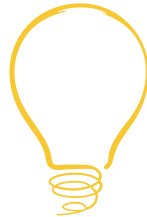

**INNOVATION
AWARD 2017**
IOP Institute of Physics

Copyright © Ossila 2019

Ossila.com