

# Lawn Mower User Manual



Read Carefully Before Use  
Keep for Future Reference

# Contents

<b>1. Safety Information</b>	<b>1</b>
1.1 General Safety	1
1.2 Workspace Safety	1
1.3 Personal Safety	2
1.4 Electrical Safety	3
1.5 Engine Safety	3
1.6 Mowing Safety	4
1.7 Maintenance Safety	4
<b>2. Specifications</b>	<b>5</b>
<b>3. Product Diagram</b>	<b>6</b>
3.1 Front and Left	6
3.2 Right	6
3.3 Rear	7
3.4 Bottom	8
<b>4. Package List</b>	<b>8</b>
<b>5. Preparation</b>	<b>10</b>
5.1 Unpacking	10
5.2 Inspecting the Components	10
5.3 Filling the Fuel Tank	11
5.4 Checking the Engine Oil	11
5.5 Preparing Your Lawn	12
5.6 Personal Protective Equipment	12
<b>6. Operation</b>	<b>13</b>
6.1 Powering on the Mower	13
6.2 Driving the Mower to Your Lawn	14

6.2.1	Activating the Remote Control .....	14
6.2.2	Selecting a Running Speed .....	14
6.2.3	Driving and Managing the Direction .....	14
6.2.4	Cruise Control.....	15
6.3	Initiating the Engine .....	16
6.4	Mowing .....	17
6.4.1	Adjusting the Cutting Height .....	17
6.4.2	Activating the Front Warning Lights.....	17
6.5	After Mowing.....	18
<b>7.</b>	<b>Maintenance.....</b>	<b>19</b>
7.1	Replacing the Engine Oil.....	19
7.2	Replacing the Engine Filter .....	20
7.3	Replacing the Cutting Blades .....	21
7.4	Replacing the Fuses.....	22
7.5	Charging the Battery.....	23
7.6	Maintaining the Tracks.....	23
7.6.1	Testing the Tension.....	23
7.6.2	Retightening a Track.....	24
7.7	Cleaning .....	25
7.8	Overall Check.....	25
7.9	Storage.....	25
<b>8.</b>	<b>Troubleshooting .....</b>	<b>26</b>
8.1	Engine .....	26
8.2	Mowing .....	27
8.3	CNAOM Light .....	27
8.4	Remote Control .....	28
<b>9.</b>	<b>Disposal.....</b>	<b>28</b>

# 1. Safety Information



## Warning!

### 1.1 General Safety

- Read **ALL** these instructions carefully before use, keep them in a safe and easily accessible place for future reference, provide them to anyone who will operate, maintain, or repair this mower, and provide them with this mower if it is ever given or sold to a third party. If any point is unclear, contact customer service or your local dealer for clarification and assistance. Failure to do so may result in equipment damage and personal injury.
- **ONLY** use this mower for its intended purpose, trimming grass to a desired height and creating a neat and well-kept appearance for lawns. It is **NOT** a toy and should **NOT** be used playfully, carelessly, or for any other purposes.
- **ALWAYS** observe **ALL** applicable local and national laws and regulations when using this mower.

### 1.2 Workspace Safety

- **ONLY** use this mower outdoors. Indoor use can be dangerous, as the gasoline-powered engine may produce carbon monoxide and other harmful emissions, posing a serious health hazard.
- **ALWAYS** familiarize yourself with the layout of your lawn and yard. Understand the contours, potential obstacles, and any hidden hazards in your mowing area. Take note of the locations of trees, rocks, precipices, pools, holes, toys, ropes, supply lines, or any other objects that can obstruct your mowing path, create tripping or stumbling risks, potentially damage this mower, or pose other safety concerns.
- **DO NOT** drive this mower to slopes exceeding 45 degrees.
- **DO NOT** use this mower in misty or foggy conditions. Poor visibility makes it challenging to detect obstacles, uneven terrains, or other potential hazards in your path, which may lead to accidents.
- **DO NOT** use this mower in snowy conditions. Snow and ice can disrupt its cutter's functionality, damage the blades, create hazardous slippery surfaces, and makes it difficult to see obstacles or other potential hazards.
- **DO NOT** use this mower in rainy or other wet conditions. Damp grass can be slippery, increasing the risk of slips and falls, and can clog the blades, resulting in an uneven and messy cut. Mowing wet grass can also lead to ruts and damage to the soil, potentially causing long-term harm to your lawn. **MOREOVER**, wet conditions can create electrical hazards and pose the risk of electric shock.
- Keep your workspace clean and well lit. Cluttered or dark areas invite accidents. **DO NOT** use this mower on graveled surfaces, as hard sharp stones can damage the blades and loose debris propelled by the rotating cutter can be dangerous.

- **DO NOT** allow children or pets to enter the workspace during use. If necessary, restrict access to the area using appropriate barriers or warning signs.
- **NEVER** operate or maintain this mower in the presence of explosive or flammable gases, liquids, or dust. Fuel containers, aerosol cans, firecrackers, paper piles, open flames, and other similar objects **MUST** be kept away from the workspace.

## 1.3 Personal Safety

- **DO NOT** allow use by children, anyone who has not read these instructions, or any person whose mental or physical impairment precludes safe use. **ANY** bystanders should be made aware of the potential dangers and maintain a safe distance from your workspace.
- **DO NOT** leave children playing with **ANY** packaging materials, which may cause accidents and injury.
- **DO NOT** use this mower while you are tired or under the influence of drugs, alcohol, or strong medication.
- **ALWAYS** wear appropriate personal protective equipment (PPE) including hearing protection and nonslip footwear. Additional PPE such as breathing, eye, hand, leg, and skin protection may also be necessary, depending on the weather and lawn conditions. Breathing protection **MUST** be able to filter all particles generated by your work. A dust mask or respirator is highly recommended. Anyone allowed nearby during use should wear equivalent PPE.
- Maintain a safe distance from this mower while it is running. Exercise caution to avoid being in its path as it moves toward you.
- **NEVER** insert any body parts or foreign objects under this mower when the engine is starting or running. The cutter begins once the engine initiates.
- **NEVER** place any body parts near or on the tracks, wheels, or any moving parts in the main bay during use.
- **NEVER** sit or stand on this mower, whether it is in operation or not.
- **NEVER** place any body parts or other objects in the area that this mower may cover when it is lowered back from its upright position. Use **EXTREME** care to avoid the risk of crush injury while raising or lowering its left side to access its cutting blades.
- **DO NOT** touch any heated parts with bare skin during or shortly after use, as they can be hot and cause burn. These parts include the engine, its filter, electric generator, battery, fuse holder, exhaust fan, and cutter.
- If the battery is ever damaged, avoid **ALL** contact with it or any leaking fluid. Remove contaminated clothing and flush with copious amounts of water if contact accidentally occurs with the skin. If contact accidentally occurs with eyes, **IMMEDIATELY** flush them with copious amounts of water for at least 15 minutes while seeking medical attention.

## 1.4 Electrical Safety

- **DO NOT** get any electrical components wet or operate them with wet hands. **DO NOT** rinse this mower or expose it to rain. **ALWAYS** avoid direct pressurized spray towards the main bay, control panel, charging port, and electrical compartment's air inlet and outlet. If any electrical components accidentally become wet, turn off the power and wait for them to dry completely before further use.
- **ALWAYS** power off this mower between uses and before opening its electrical compartment.
- **NEVER** disassemble or modify this mower's battery. **NEVER** expose the battery to explosives, flammables, radiation, heat sources, or excessive pressure.
- **ONLY** use this mower with the provided charger. **DO NOT** charge its battery using other equipment. **NEVER** get the charger wet or operate it with wet hands.
- **ONLY** charge this mower in locations with an ambient temperature of 32–104°F (0–40°C). For best results, charge it at temperatures within 77–86°F (25–30°C). **DO NOT** leave it unattended for an extended period of time during charging. **DO NOT** overcharge the battery or allow it to drain completely.
- **ONLY** use the provided fuses to replace their identical ones inside the electrical compartment. **DO NOT** mix them up or install them to incorrect positions.
- **ONLY** allow servicing by trained technicians for the other electrical components.

## 1.5 Engine Safety

- **NEVER** disconnect, disassemble, or modify the engine by yourself or untrained persons.
- **ONLY** rely on trained technicians for engine servicing.
- **ALWAYS** turn off the engine and throttle before filling the fuel tank.
- **DO NOT** leave the engine or throttle on when adding or replacing the engine oil.
- After the engine stops, wait at least two minutes before removing its fuel filler cap. The residual heat may cause the gasoline vapor to ignite, posing fire and explosion hazards. Also, follow this rule for the engine oil filler to prevent hot oil splattering.
- **DO NOT** use fuels or engine oils other than those specified in the **Specifications** section.
- **DO NOT** overfill the fuel tank. This may lead to fuel leakage, vapor emissions, and reduced engine performance.
- **DO NOT** overfill or underfill the engine oil tank. Both may result in abnormal pressure and overheating within the engine.
- **NEVER** run the engine without oil or filter.
- Be careful **NOT** to spill fuel or oil to prevent the risks of fire, explosion, and contamination.
- To raise this mower to its upright position, ensure that **BOTH** the fuel and oil fillers **ARE** completely closed. Avoid raising the right side to prevent the carburetor from facing downward, which may cause engine flooding and fuel leakage.

## 1.6 Mowing Safety

- **ALWAYS** ensure that **ALL** components and fasteners **ARE** intact and securely tightened before and after each use.
- Stop use **IMMEDIATELY** if detecting **ANY** misalignment or binding of parts, breakage of components, or any other condition that may affect this mower's safe operation. **DO NOT** resume use until the issue is totally addressed.
- Stay focused but alert while mowing. Avoid distractions and maintain awareness of potential obstacles and people in the vicinity.
- Be mindful of terrains and any slopes or uneven areas. Adjust your mowing technique accordingly to maintain stability and prevent slips or loss of control.
- **DO NOT** force this mower. If the blades strike any firm obstacle during use and begins to vibrate or gets stuck in any way, stop the mower **IMMEDIATELY** and reverse it from the obstacle carefully.
- **DO NOT** allow **ANY** foreign objects to enter **ALL** exposed ports or vents on this mower.
- **DO NOT** place other objects on this mower during use.
- **DO NOT** leave this mower unattended during use.

## 1.7 Maintenance Safety

- **ALWAYS** shut off the electric power, engine, and throttle before performing cleaning, refilling, inspection, replacement, repair, or other maintenance.
- Dress properly. **DO NOT** wear loose clothing or jewelry when performing maintenance or repair. Keep your hair, clothing, and gloves away from any moving parts when testing or adjusting them. To handle sharp or heated parts, wear proper hand protection.
- **DO NOT** clean this mower with harsh abrasives or caustic chemicals.
- For cutter maintenance, use two or more persons to raise this mower. **DO NOT** raise its front or rear side, which may cause damage to the control panel or front warning lights. **NEVER** turn the mower upside down. When returning the mower to its original position, go slowly and with great care.
- **NEVER** replace **ANY** components with nonidentical ones.
- Maintain **ALL** labels on this mower. If any of them comes loose or becomes illegible, re-affix it or ask your local dealer for a replacement before further use.
- **DO NOT** unlock the remote control's function buttons for **ANY** random adjustment. If such adjustment accidentally happens, resume the original settings and relock the buttons as soon as possible.
- Store this mower and its accessories out of the reach of children and other untrained persons.

# 2. Specifications

Overall	Model		HT550CF	
	Average Noise Level		100 dB(A)	
	Dimensions		35.8×36.6×21.7 in.	91×93×55 cm
	Net Weight		298 lb.	135 kg
Cutter	Blade Material		Manganese Steel	
	Cutting Width		21.7 in.	55 cm
	Cutting Height Range		0.4–5.1 in.	1–13 cm
	Max. Cutting Area*		1196 sq. yd.	1000 m <sup>2</sup>
Tracks	Material		Rubber	
	Slope Capacity		45°	
	Width		5.9 in.	15 cm
	Speed*	Low	1.8 mph	3 km/h
High		3.6 mph	6 km/h	
Fuel	Compatible Types		≥92 Octane Gasoline, E0 or E10	
	Tank Volume		0.4 gal.	1.5 L
	Consumption		0.2 gal.	0.8 L/h
Engine	Model		Loncin 1P70FC	
	Type		4-Stroke, Single-Cylinder, Forced Air Cooling	
	Max. Torque		7.5 lbf•ft. at 2500 rpm	10.2 N•m at 2500 rpm
	Max. Power		7.5 HP at 3600 rpm	3.5 kW at 3600 rpm
	Displacement		12 cu. in.	196 cc
	Oil	Compatible Types	SAE 10W-30 at -4 to 104°F SAE 5W-30 at -22 to 32°F	SAE 10W-30 at -20 to 40°C SAE 5W-30 at -30 to 0°C
		Tank Volume	0.85 qt.	0.8 L
Speed	Idle	2200±150 rpm		
	Max.	3600 rpm		
Electric Generator	Rated Power		1500 W	
	Max. Output Voltage		12 V	
	Max. Output Current		125 A	
Battery	Type		12V 12AH Lead-Acid	
	Cruising Distance*		109 yd.	100 m
	Charging Temp. Range		32–104°F	0–40°C
Charger	Input Voltage & Freq.		110–240 V AC~ 50/60 Hz	
	Output Voltage & Current		12–14.8 V DC~ 1.7 A	
Remote Control	Compatible Battery Type		AA (×4)	
	Max. Distance**		109–545 yd.	100–500 m

\* Based on full battery power on a level soil surface

\*\* Affected by variables such as battery power, obstacles, weather, and other radio signals



# 3. Product Diagram

## 3.1 Front and Left

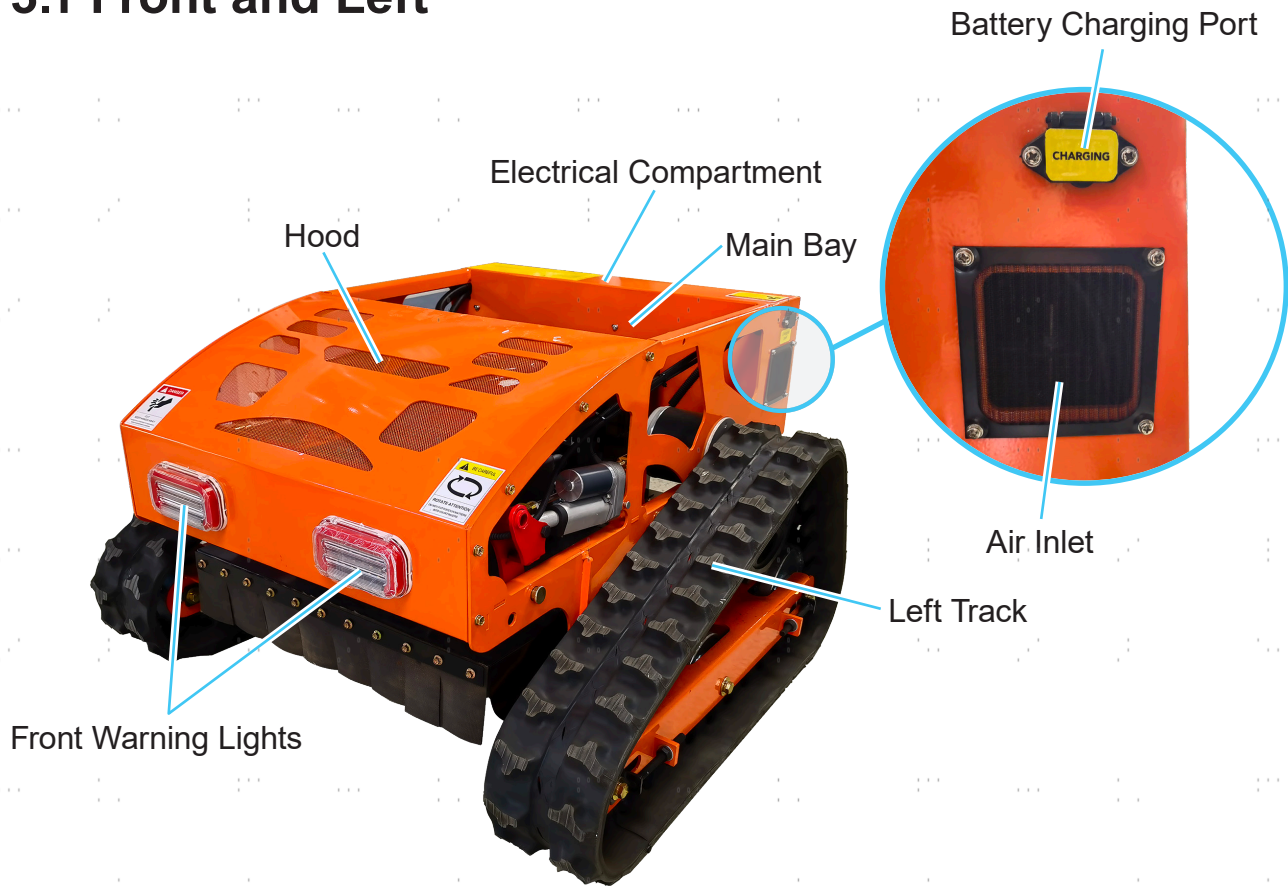

## 3.2 Right

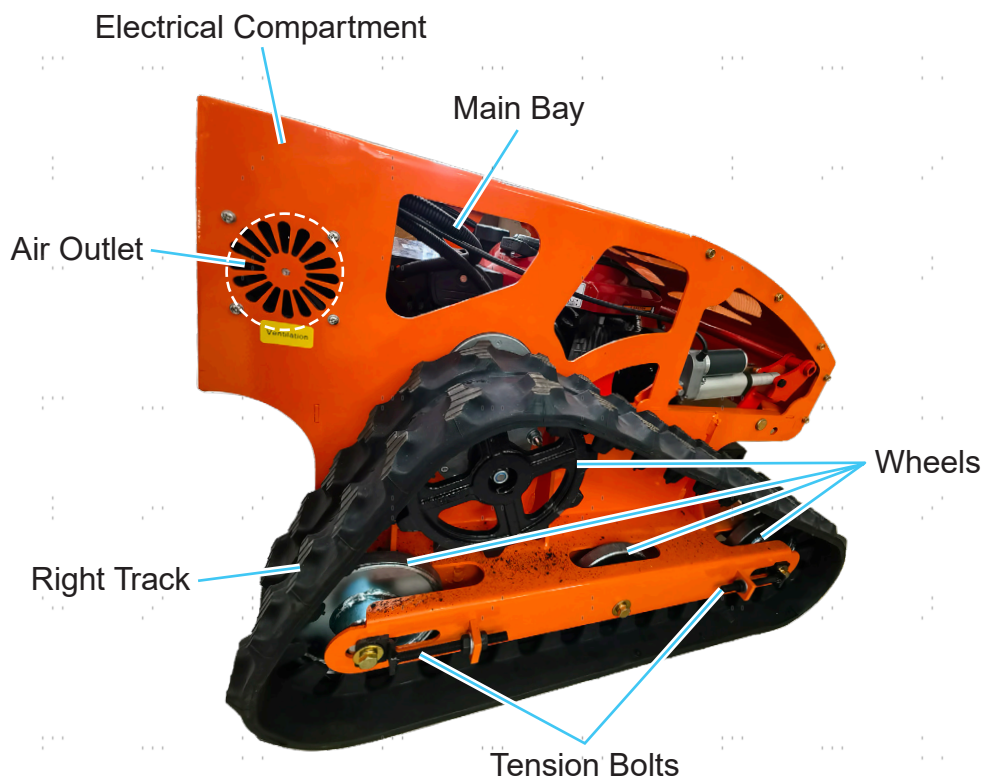

### 3.3 Rear

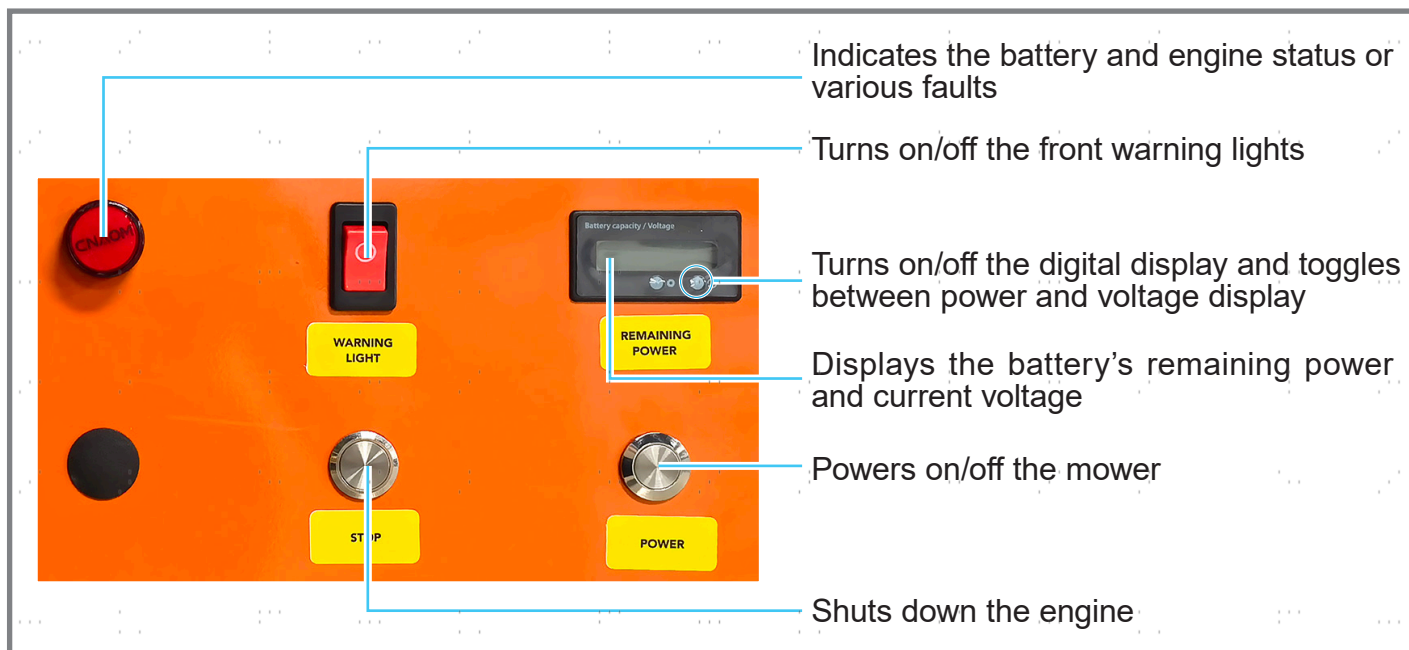
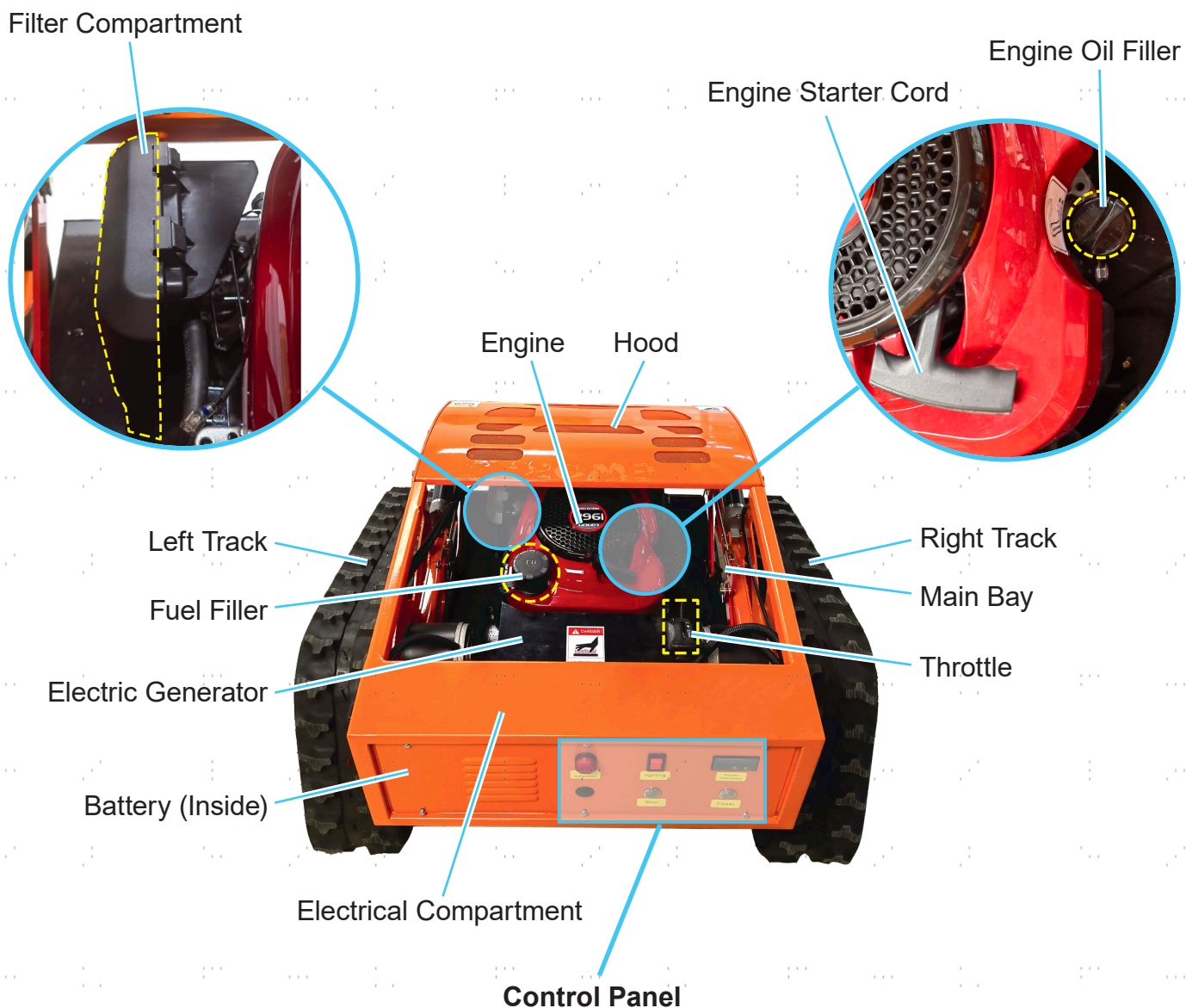

### 3.4 Bottom (Rotational Cutter)

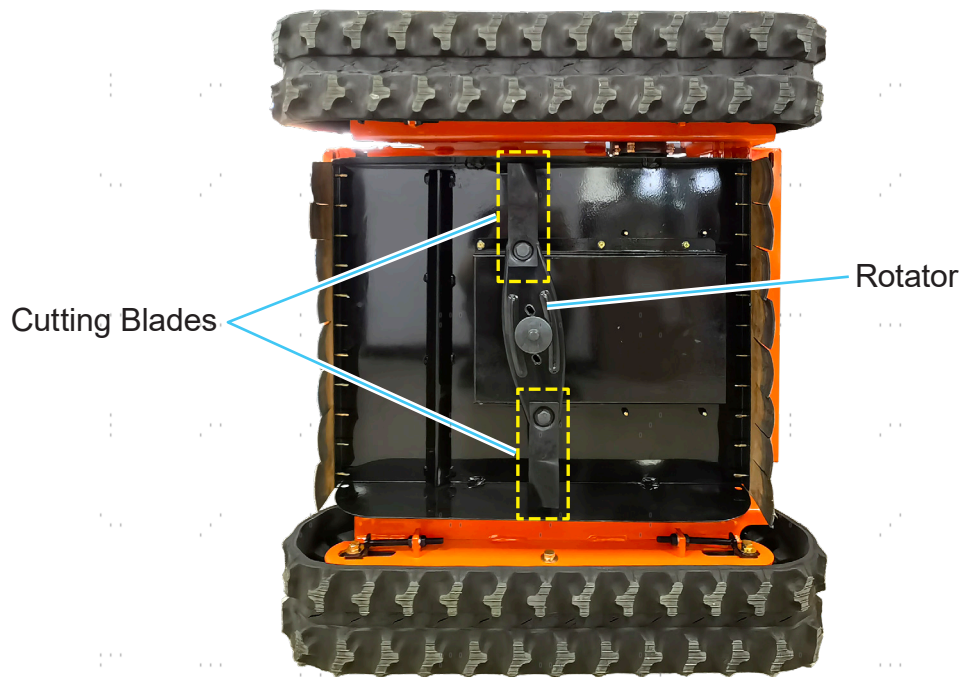



## 4. Package List







### Essentials

<p>A      Lawn Mower</p>  <p>× 1</p>	<p>B      Remote Control</p>  <p>× 1</p>	<p>C      Battery Charger</p>  <p>× 1</p>
---	---	--

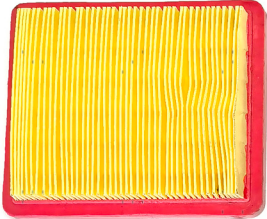
## Tools

<p>D Dual-Purpose Screwdriver</p>  <p style="text-align: right;">× 1</p>	<p>E Socket Wrench</p>  <p style="text-align: right;">× 1</p>	<p>F Handle</p>  <p style="text-align: right;">× 1</p>
---	--	---

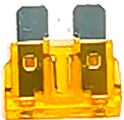
## Spares

<p>G Engine Filter</p>  <p style="text-align: right;">× 1</p>	<p>H Cutting Blades</p>  <p style="text-align: right;">× 2</p>	
<p>I Blade Bolts</p>  <p style="text-align: right;">× 2</p>	<p>J Blade Nuts</p>  <p style="text-align: right;">× 2</p>	<p>K Blade Washers</p>  <p style="text-align: right;">× 2</p>
<p>L 5A Fuses (Yellow)</p>  <p style="text-align: right;">× 2</p>	<p>M 15A Fuses (Blue)</p>  <p style="text-align: right;">× 4</p>	<p>N 50A Fuses (Red)</p>  <p style="text-align: right;">× 4</p>

### Not Included but Necessary or Helpful:

- AA Batteries ×4
- ≥92 Octane Gasoline, E0 or E10
- SAE 5W-30 Engine Oil
- Oil Extractor Pump
- Funnel
- Adjustable Wrench
- Force Gauge
- Tape Measure
- Jack Stand

# 5. Preparation

## 5.1 Unpacking

1. Unpack your new mower (A), **FULLY** disassembling the packaging crate's top and walls. Perform this near your lawn for future convenience.
2. Remove the remote control (B), battery charger (C), as well as all tools and spares specified in the **Package List** section from the main bay. Check that they are **ALL** intact and in good condition. If necessary, ask the local dealer for supplements or replacements.



**DO NOT** allow children or pets to play with any packaging without close and constant supervision.

3. Open the battery box at the remote's back by pulling its tab. Insert four AA batteries (not included) into place and then close the box.

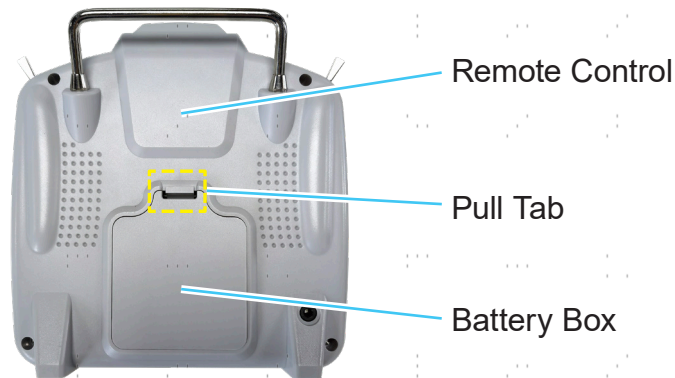

4. Power on the mower and remote control, drive it away from the crate's bottom, and turn off the power. For more details, refer to the **Operation** section.

**Note:** The battery inside the electrical compartment only allows for a maximum travel of 109 yards (100 m) at its full power.

## 5.2 Inspecting the Components

Inspect the front warning lights, tracks, control panel, main bay, and the rotational cutter for any signs of looseness or breakage. Correct any problematic parts or seek professional assistance from your local dealer as needed.

To access the cutter beneath the mower, have 2 to 3 persons assist in raising and supporting the **LEFT** side of the mower.



**DO NOT** raise the mower's rear or front side, which may result in damage to the front warning lights or items on the control panel.



**DO NOT** turn the mower **COMPLETELY** upside down.



**NEVER** place any body parts or other objects within the area that the mower may cover when it is lowered back in place. Exercise **EXTREME** caution when raising or lowering it to prevent accidental crushing.

## 5.3 Filling the Fuel Tank

### **DANGER!**

Ensure that **ALL** of the following conditions **ARE** fulfilled **BEFORE** filling the fuel tank.

- The area is well-lit and ventilated.
- **NO** open flames or sparks are nearby.
- The throttle lever is **FULLY** pulled back.
- Your fuel is correct ( $\geq 92$  Octane Gasoline, E0 or E10).

1. Unscrew the cap of the fuel filler.
2. Carefully pour your fuel into the filler. For best results, use a clean funnel (not included) or other similar tools to avoid spilling the fuel around.
3. Stop pouring when the fuel level reaches 1.5 inches (4 cm) below the filler port. **DO NOT** overfill.
4. Replace and **FULLY** tighten the cap. Wipe the area clean if needed.

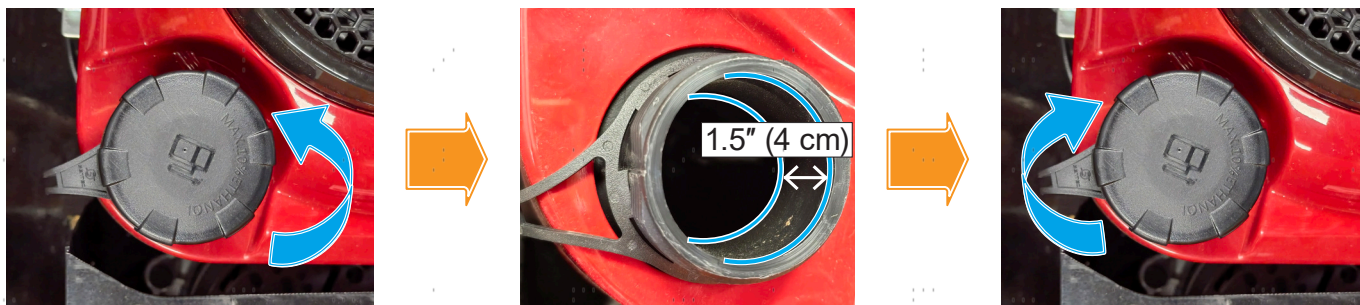

## 5.4 Checking the Engine Oil (Optional)

The engine is already filled with SAE 10W-30 oil, which is effective in most conditions. **HOWEVER**, it is recommended to use SAE 5W-30 oil (not included) on very cold days, especially when the ambient temperature is below  $-4^{\circ}\text{F}$  ( $-20^{\circ}\text{C}$ ). For replacement instructions, refer to **Replacing the Engine Oil** in the **Maintenance** section.

 **DO NOT** run the engine without oil or with insufficient or excessive oil.

## 5.5 Preparing Your Lawn

- If your lawn is rather wet, allow time for the grass to dry.
- Use barriers or warning signs to restrict access for bystanders, children, and animals.
- Remove obstacles from the lawn, such as branches, stones, snow, ice, toys, and potted plants.
- Mark or enclose the locations of waters, precipices, and hidden objects like hoses, pipes, and electric wires.

## 5.6 Putting on Personal Protective Equipment

- **Eyes:** Safety glasses or goggles to protect your eyes from flying debris
- **Hearing:** Earplugs or earmuffs to guard against the noise generated by the mower
- **Breathing:** Dust masks or respirators to prevent inhaling airborne particles
- **Legs:** Long pants to protect your legs from flying debris, which might be sharp
- **Feet:** Sturdy and closed-toe shoes or boots with slip-resistant soles to protect your feet and provide good traction
- **Sun Protection:** Wide-brimmed hats and sunscreen to protect against sunburn if you are going to mow in the sun

# 6. Operation

## 6.1 Powering on the Mower

On the control panel, press the **POWER** button to power on the mower. The digital display should light up; the **CNAOM** light should come on; the exhaust fan inside the electrical compartment should start working.

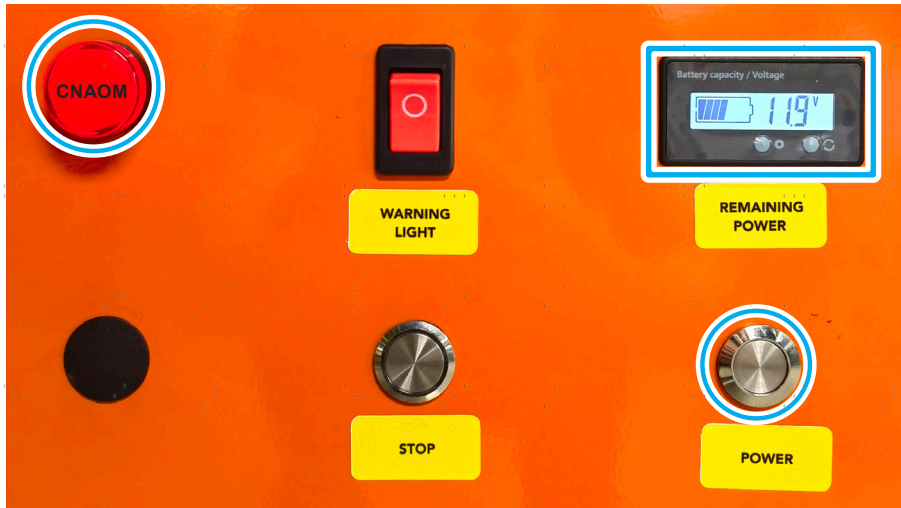

If needed, use the  button to toggle between the battery voltage and power display or to shut off and reactivate either display.

 The battery enables a maximum travel of 109 yards (100 m) at its full power. If you need to drive a longer distance to reach your lawn, closely monitor the battery power display and recharge it before it falls to 20%. **DO NOT** allow the battery to drain completely. For more details, refer to **Charging the Battery** in the **Maintenance** section.

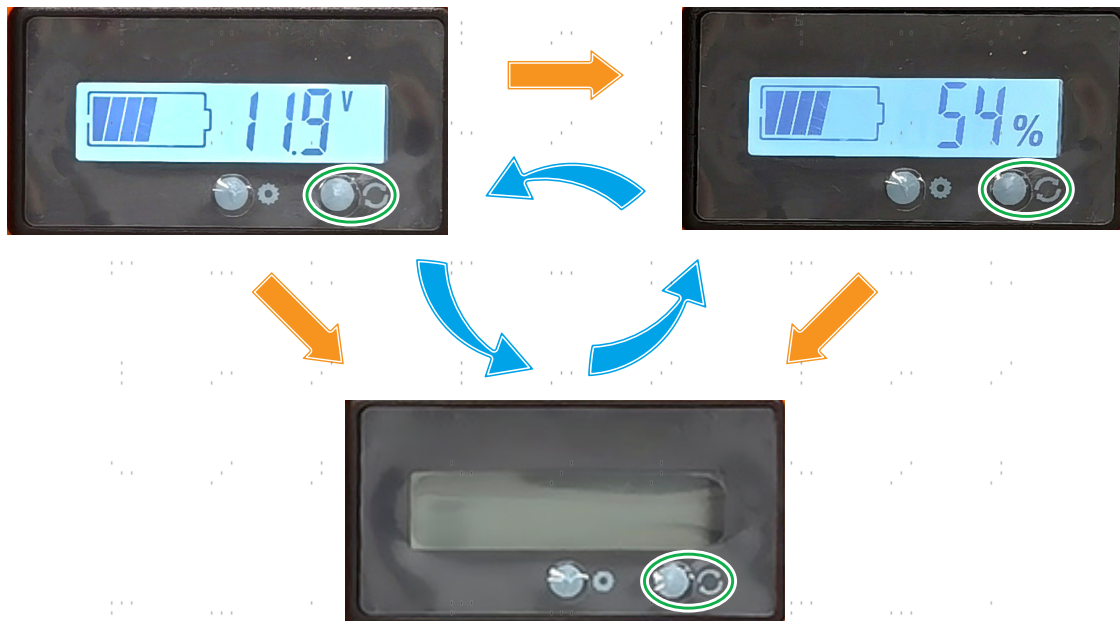



## 6.2 Driving the Mower to Your Lawn

### 6.2.1 Activating the Remote Control

On the remote control, hold the **POWER** button until four consecutive clicks go off. The **POWER** and **RF** lights should come on; the digital display should light up.



### 6.2.2 Selecting a Running Speed

Choose a running speed using the front left corner bar. Push down for low speed and pull up for high speed.

#### Speed Selector ("SW-C")



### 6.2.3 Driving and Managing the Direction

Drive the mower to your lawn using the direction control levers. Push the left lever for forward motion or pull it back for reverse. To turn left, pull the right lever to the left; for a right turn, pull it to the right. Keep holding a lever for continuous motion and release it to stop the motion.



## 6.2.4 Cruise Control (Optional)



Cruise control allows you to drive the mower at a constant speed without holding the left lever.

1. Hold the left lever forward or backward while pulling up the front right corner bar.
2. When the **RF** light flashes, release the lever to activate cruise control for automatic forward or reverse motion.
3. Use the right lever to turn left or right as needed.
4. To cancel cruise control, pull the switch bar again. The mower will stop and **RF** cease flashing.



### CAUTION!

The remote's function buttons (**MENU**, **EXIT**, **MONITOR**, **▲**, and **▼**) were pre-locked at the factory, except . To unlock them, hold  until the  icon disappears from the display's lower right corner.

However, **ALL** factory settings **ARE** already optimized for seamless compatibility between your remote and mower. Making random adjustments may lead to inaccurate responses from your remote control. If such adjustment happens accidentally, resume the original settings **IMMEDIATELY** and use  to lock these buttons again. For best results, **NEVER** unlock at **ANY** time and ensure  remains during each use.

## 6.3 Initiating the Engine

1. Activate the throttle by pushing its handle forward. The further it goes, the higher the throttle level is.



2. Pull the engine starter cord **quickly** and **forcefully**. Then, release the cord. This should start the engine, turn off the **CNAOM** light, and activate the rotational cutter underneath the mower. If it does not work on the first attempt, try this action again.



## 6.4 Mowing

Use the remote control to drive the mower as described above, allowing its rotating blades to mow each desired area of your lawn.

 Be attentive **BUT** stay alert during work. In case of excessive vibration, stop the mower, inspect the situation, and address the problem before continuing use.

### 6.4.1 Adjusting the Cutting Height

To suit your lawn, use the **SW-A** bar for cutting height adjustment. Push the bar forward to lower the cutter; pull the bar back to raise it. Holding the bar continues the rising or descending movement; releasing the bar stops either movement.

Cutting Height Adjustment  
("SW-A")



### 6.4.2 Activating Front Warning Lights

For optimal safety, turn on the front lights to warn people or animals about the upcoming mower, especially at night or on cloudy days when visibility is limited.

 Again, it is **NOT** advisable to mow after dark or under poor visibility. Also obey local laws and regulations.

Flip the **WARNING LIGHT** switch on the control panel to **O** and the front lights should begin to flash. To deactivate the lights, flip the switch back in place.

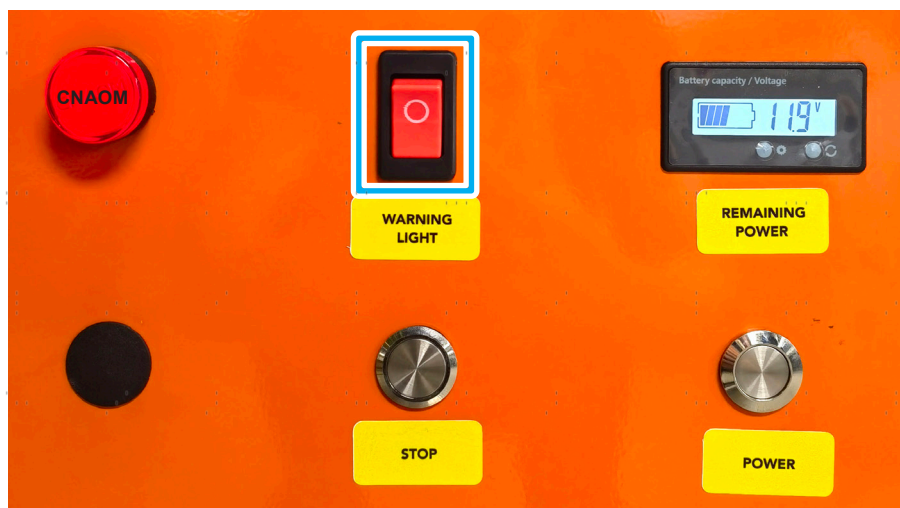

## 6.5 After Mowing

1. Raise the cutter, drive the mower to an appropriate location, and then stop it using the remote control.
2. On the control panel, hold the **STOP** button until the engine ceases operation. The cutter should stop rotating and the **CNAOM** light come on again.
3. Shut down the throttle by pulling its lever completely back.
4. On the remote control, hold the **POWER** button until its display and lights turn off.
5. On the control panel, press the **POWER** button to power off the mower. The digital display, exhaust fan, and **CNAOM** should turn off.

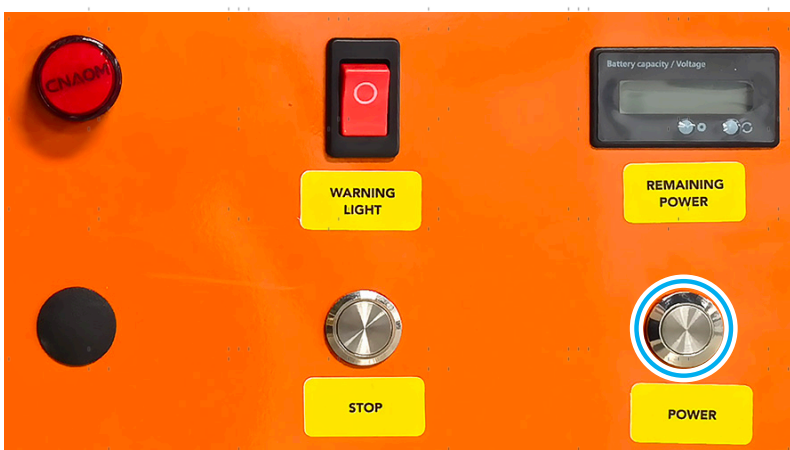
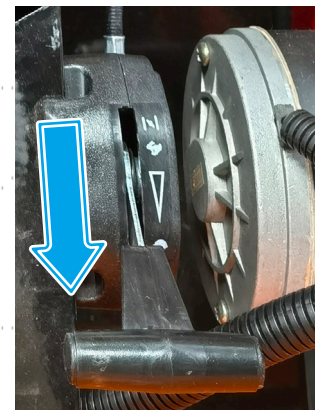
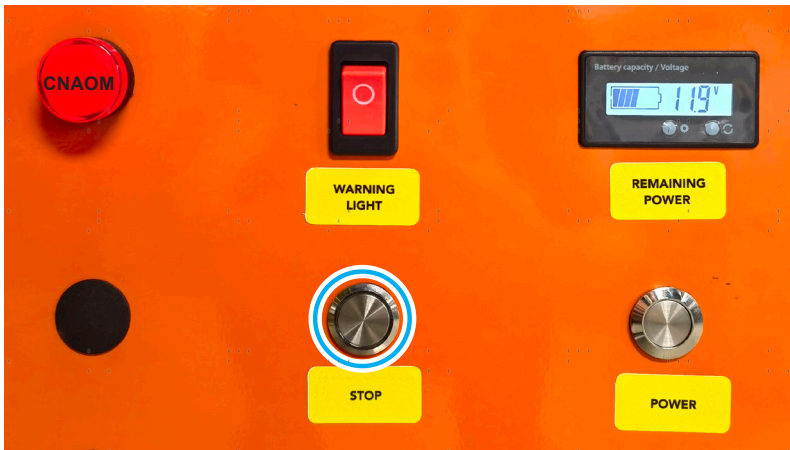

# 7. Maintenance

## DANGER!

Ensure that **ALL** of the following conditions **ARE** fulfilled before performing any maintenance or repair.

- The engine, throttle, and electric power are **COMPLETELY** shut off.
- **ALL** heated parts to be touched have cooled, especially the engine, oil dipstick, electric generator, and cutting blades.
- The maintenance area is clean, ventilated, well-lit, and free from sources of ignition.
- **ALL** proper PPE necessary for your work is put on.

## 7.1 Replacing the Engine Oil

As you continue use, the engine oil will go dark or turbid, leading to reduced lubrication, overheating, sludge buildup, decreased fuel efficiency, and increased emissions for the engine. To maintain optimal performance, replace the engine oil every 25 to 50 hours of operation.

1. Unscrew the cap of the engine oil filler, wipe its dipstick clean, and place it on a paper towel or cloth or in a dedicated container nearby.
2. Remove the old oil using a hand extractor pump (not included). Direct the oil into a suitable container and dispose of it properly.
3. Add your new engine oil slowly and carefully, using a funnel to avoid spills.

 **ONLY** use the correct engine oil as described in the **Specifications** section.

4. After adding a certain amount, replace the cap, reinserting its dipstick.
5. Unscrew the cap again and check the dipstick's threaded tip. If it is not oiled, continue to add. If it is partially or fully oiled, the oil is sufficient. If the oil line exceeds the threading, extract excess amount. If necessary, repeat this step several times. **DO NOT** overfill or underfill.
6. When finished, replace and tighten the cap.

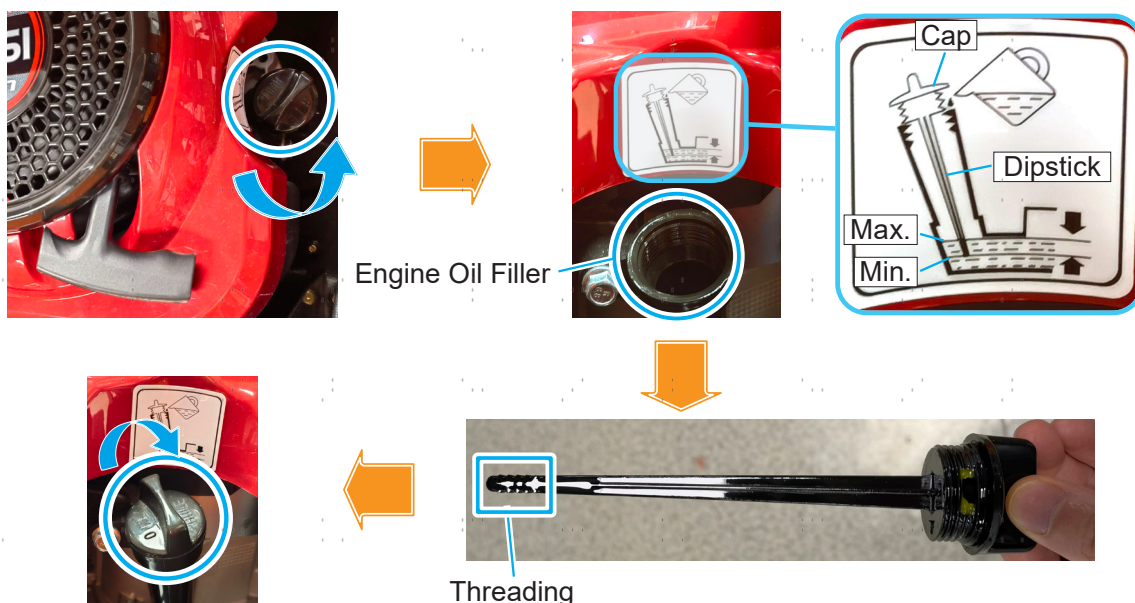

## 7.2 Replacing the Engine Filter

A dirty filter restricts air flow to the engine's carburetor, reducing the engine's performance, increasing fuel consumption, and even causing excessive smoke or unusual odors. Periodically check the filter located at the engine's front left corner. Clean or replace the filter as needed.

1. Press down on the two latches until the filter compartment opens.
2. Take the filter out of its compartment.
3. If the filter is lightly contaminated, tap it clean or use compressed air ( $\leq 30$  psi or 2 bar) to blow through its base until dirt is removed. When finished, fit the filter back in place.

If the filter is heavily contaminated or blocked, replace it with the provided spare (G).

4. Close the compartment, pushing until its cover clicks into place.

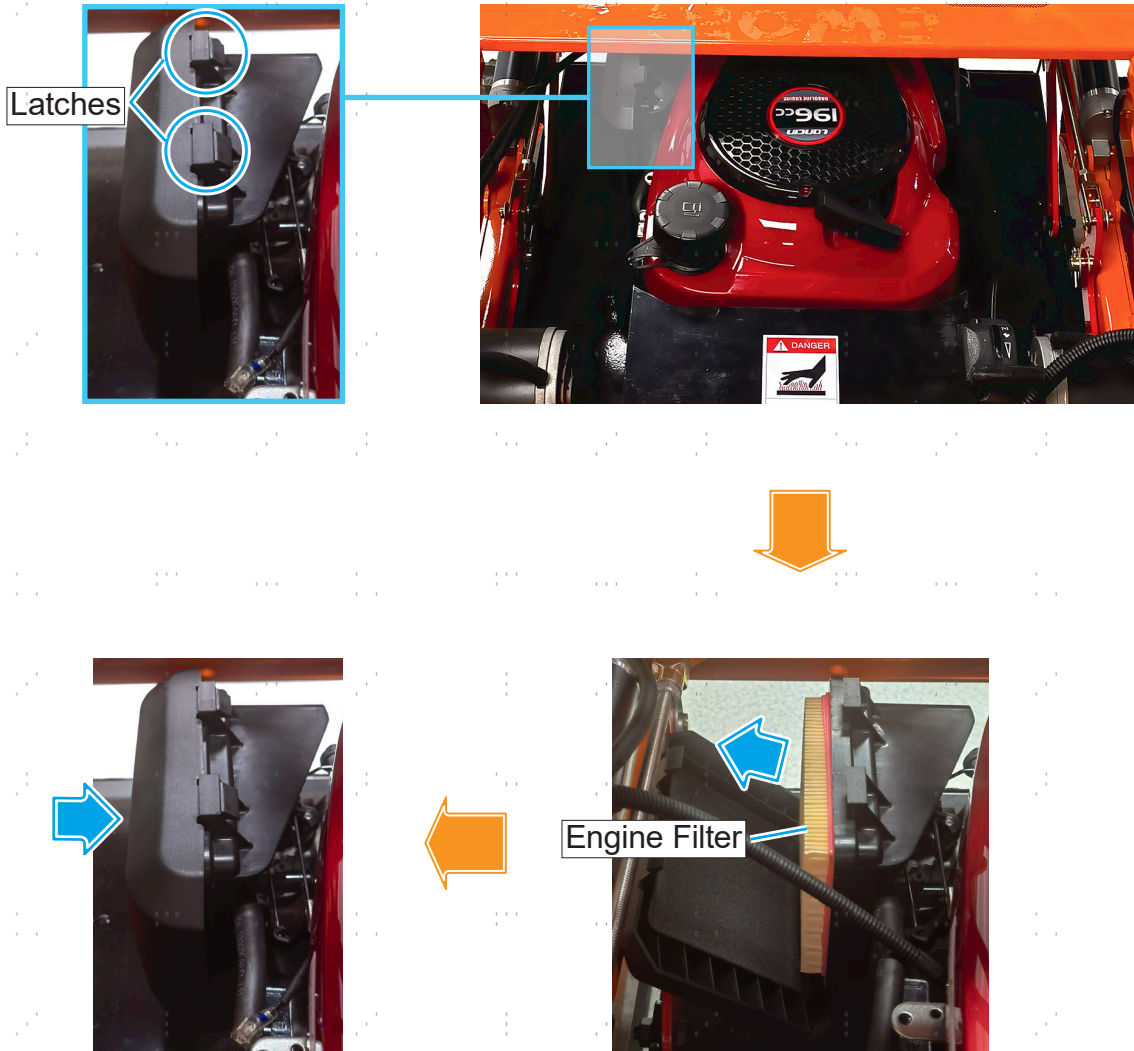

## 7.3 Replacing the Cutting Blades

Replace the blades when they no longer provide quick or smooth cuts.

1. Carefully raise the mower on its **LEFT** side so that the engine's carburetor and filter are facing up. Use two or three persons for assistance as needed.



Again, **DO NOT** turn the mower **COMPLETELY** upside down.

2. Pass the provided handle (F) through the socket wrench (E).
3. Unscrew the locking bolt from a cutting blade using the wrench.
4. Disconnect the blade from the cutter and remove its washer and nut.
5. Fix a spare blade (H) in its correct position on the cutter with the removed nut, washer, and bolt, following their original placement on the old blade. (See **Blade Mounting** below.) If necessary, use the spare fasteners (I, J, & K). Ensure that the blade's cutting edge is positioned in a way that allows it to cut in its counterclockwise rotation. For best results, apply specialized lubricant to enhance the blade's longevity and performance.
6. Repeat Steps 3–5 for the other blade as needed.
7. When finished, set the mower back in its horizontal position.

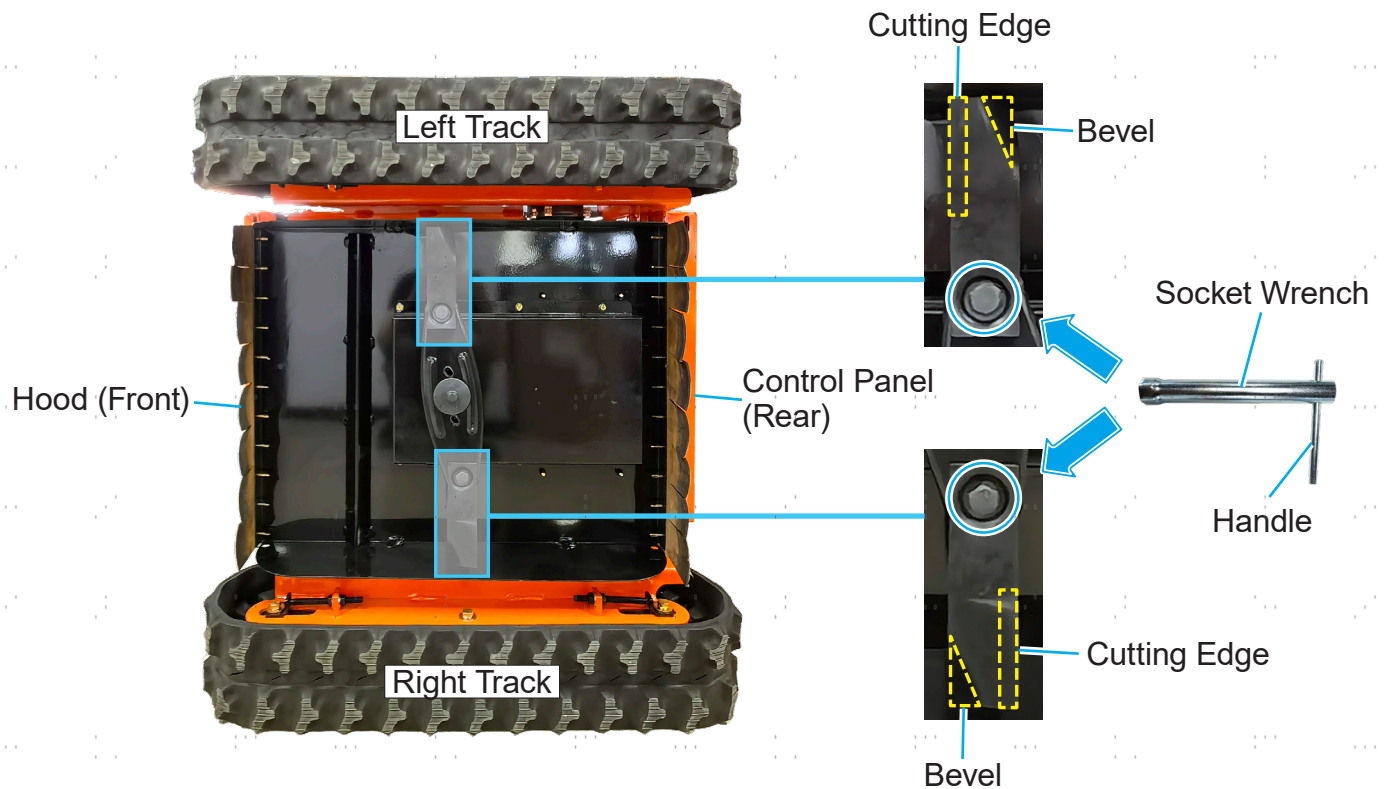

### Blade Mounting

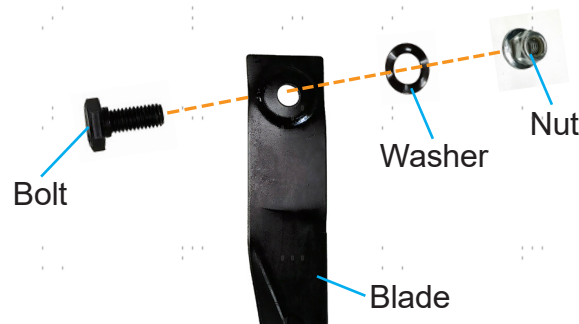



## 7.4 Replacing the Fuses

Replace the fuses to address the issues listed in the **Troubleshooting** section.

1. Unscrew the six Phillips bolts around the mower's control panel using the provided dual-purpose screwdriver (D).
2. Remove the panel, exposing the inside of the electrical compartment.
3. Pull out the fuse you are going to check. If it needs to be replaced, insert its **IDENTICAL** spare into the correct socket on the fuse holder.

 Using nonidentical fuses or incorrectly installing them **WILL** lead to inadequate or ineffective circuit protection, posing the risks of equipment damage and safety hazards.

4. When finished, replace the panel and secure it using the removed bolts.

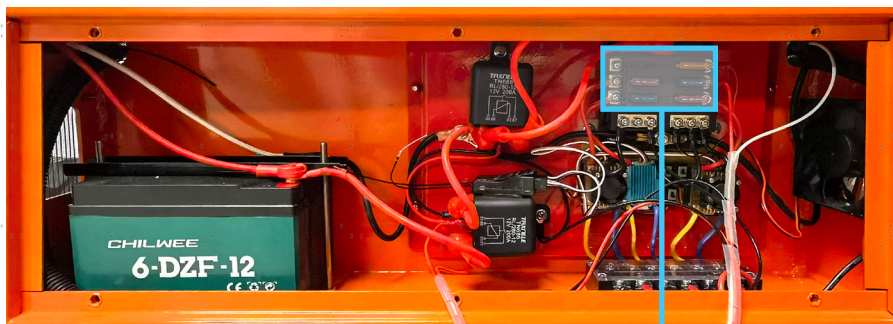
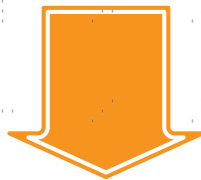

Fuse Holder

	Yellow (5)
Red (50)	Blue (15)
Blue (15)	Red (50)

## 7.5 Charging the Battery

Check the battery's remaining power as described in **Powering on the Mower** in the **Operation** section. When you find that recharging is necessary:

1. Connect the provided charger to a stable and compatible power source. The charger's indicator light should turn green.
2. Flip up the charging port's cover and connect the charger to this port. The light should turn red and charging begin.
3. When the light turns green again, the battery is fully charged. Disconnect the charger from the battery and power source.

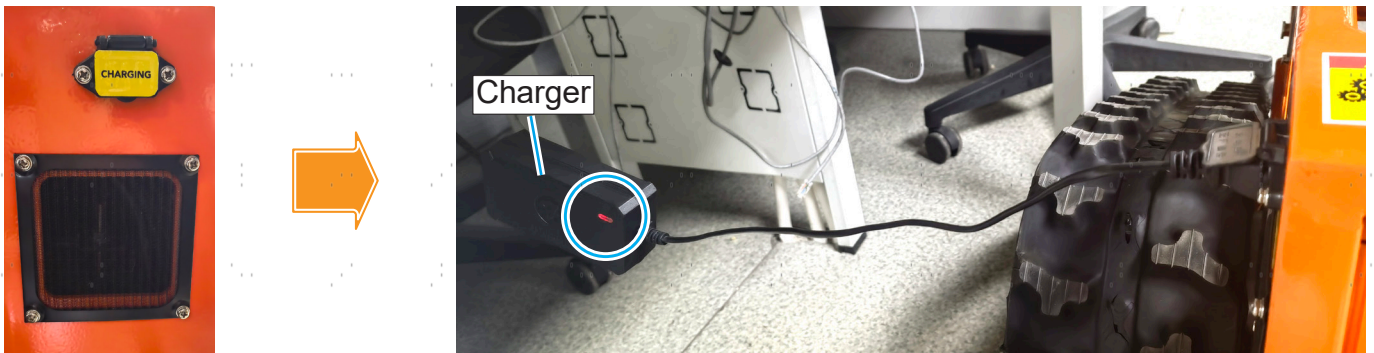

## 7.6 Maintaining the Tracks

### 7.6.1 Testing the Tension

Frequent mowing and varied terrains can gradually loosen the tracks, leading to misalignment with the wheels or even track dislodgment. To ensure safe use, regularly test the track tension as follows:

1. Place a tape measure (not included) at the center of a track's top section and then slide it down.
2. Position a force gauge (not included) near the tape measure's point on the track, ensuring that they are well aligned and vertical to the track.
3. Press down on the gauge until it reads 13.5 lbf (60 N). If the pressed point sags at 0.6 inches (15 mm) or more, the track is loose and **MUST** be retightened before further use.

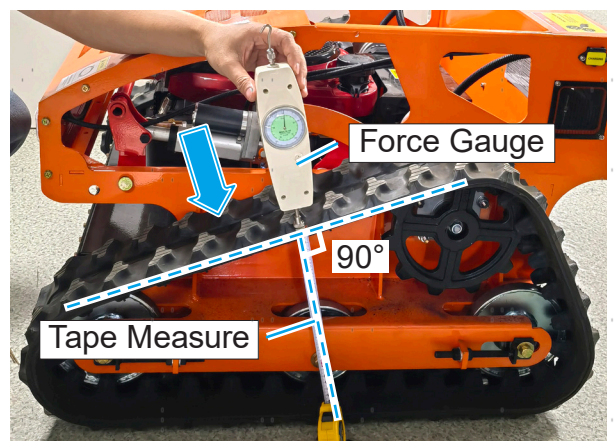

## 7.6.2 Retightening a Track

1. Reposition the loose track until it is well aligned with its wheels. If necessary, elevate and support the whole mower using jack stands (not included) or other appropriate tools beforehand.
2. On either the front or rear wheel, loosen the axle nuts at both sides using an adjustable wrench (not included).
3. Loosen the inner nut on the tension bolt in the same fashion.
4. Tighten the outer nut using your wrench, which pushes the tension bolt and wheel outwards to tighten the track. Meanwhile, the inner nut is moving back as the tension bolt goes.
5. Test the track tension as described above.

A sag of 0.3–0.5 inches (8–12 mm) is the optimal range for the correct track tension. If the sag exceeds the range, loosen the inner nut and continue to tighten the outer nut to increase the tension. If it is less than the range, loosen the outer nut and retighten the inner nut to reduce the tension. **DO NOT** overtighten.

It may require multiple attempts to achieve your ideal tension. Fine-tune the nuts one by one until they both return to the slot in between.

6. When finished, **FULLY** retighten the inner and axle nuts to secure the track in place. If necessary, adjust the tension bolt on the other wheel following the same steps.

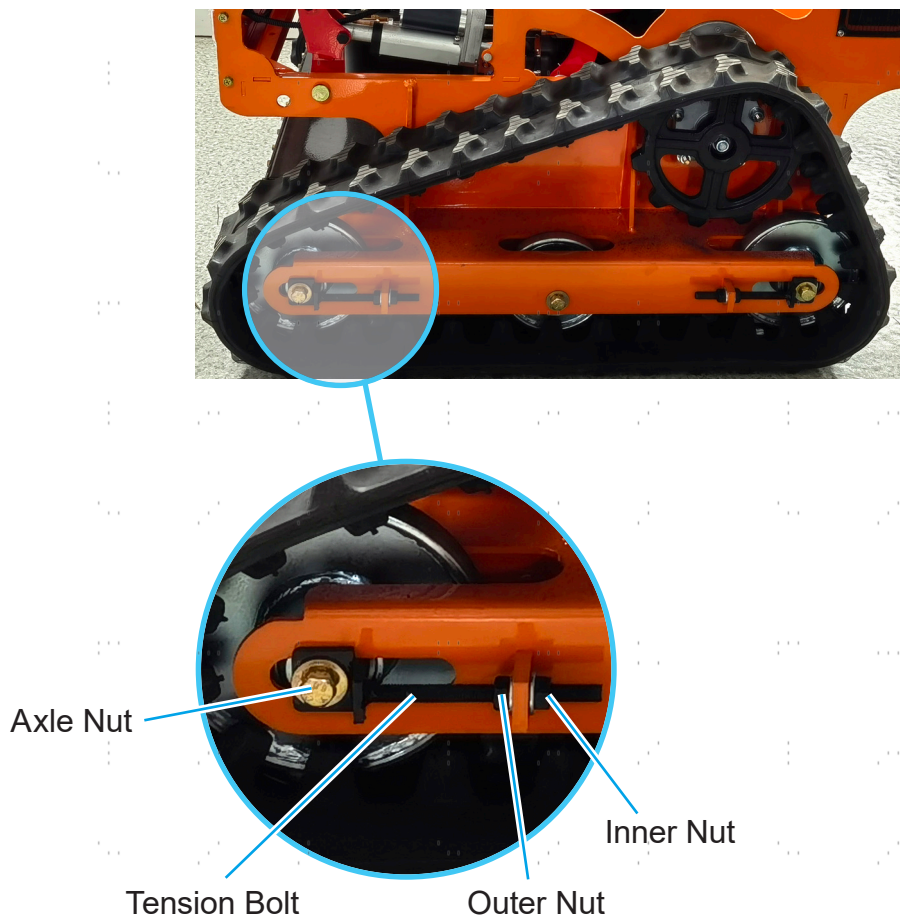

## 7.7 Cleaning

Clean the external surface of this mower after each use.

- **Hood, Tracks, Main Bay, and Control Panel:** Wipe off grass clippings and other debris using a soft cloth or brush or blow them away using OSHA-compliant levels of compressed air. For stubborn stains or dirt, apply mild detergent as needed.



**DO NOT** use harsh abrasives or caustic chemicals.



**DO NOT** rinse, as this may lead to rust or other damage.

- **Rotational Cutter and Undercarriage:** Elevate the mower as described above. Gently scrape off debris, wipe clean using a soft cloth wetted with warm water, and dry completely. If necessary, disconnect the blades before cleaning them.

## 7.8 Overall Check

Periodically check the mower for looseness, wear, damage, and any signs of malfunction. Retighten, repair, or replace any problematic components before further use. For the engine and electrical parts, seek professional assistance from trained technicians as needed.

## 7.9 Storage

If the mower is not to be used for a prolonged period of time, turn off its power, engine, and throttle, clean its surface, and empty its fuel tank before storing in a cool dry location inaccessible to children and away from direct sunlight and rain. For best results, use dedicated stabilizers to prevent the stored gasoline from going bad.

# 8. Troubleshooting

## 8.1 Engine

Possible Problems	Usual Solutions
The engine cannot start.	Ensure that the fuel type is correct.
	Ensure that the fuel tank has sufficient gasoline.
	Ensure that the engine filter is clean and unclogged.
	Ensure that the throttle is currently in its active position.
	Ensure that the starter cord is pulled quickly and forcefully. Try this multiple times as needed.
	Have the engine inspected, repaired, or replaced with a new identical one (Loncin 1P70FC). Seek professional assistance as needed.
The engine starts but immediately stops.	Ensure that the engine oil level is <b>NOT</b> below the minimum mark. (See <b>Replacing the Engine Oil</b> in the <b>Maintenance</b> section.)
	Have the engine inspected, repaired, or replaced with a new identical one (Loncin 1P70FC). Seek professional assistance as needed.
The engine emits smoke or excessive exhaust.	Ensure that the engine oil level is <b>NOT</b> above the maximum mark. (See <b>Replacing the Engine Oil</b> in the <b>Maintenance</b> section.)
	Check the engine filter and replace it if needed.
	Stop use <b>IMMEDIATELY</b> . Have a trained technician inspect for any leaks and address the issue.
Using the <b>STOP</b> button on the control panel cannot shut down the engine.	Hold <b>STOP</b> for a longer time.
	Use a trained technician to inspect the engine and all related internal components. Have any problematic parts repaired or replaced.

## 8.2 Mowing

Possible Problems	Usual Solutions
The mower vibrates excessively.	Ensure that the tracks and wheels are properly aligned and securely attached.
	Ensure that the cutting blades are not bent or damaged.
	Retighten the locking bolts that secure the cutting blades.
The mower leaves unkempt grass.	Readjust the cutting height using the remote control.
	Ensure that the cutting blades are sharp and balanced.
	Mow at a slower pace to allow enough time to cut the grass evenly.

## 8.3 CNAOM Light

When power is on, the **CNAOM** light should turn off automatically once the engine starts. If it does not turn off, refer to the following chart, inspect the mower, find out the problem, and address the issue.

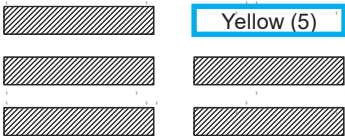
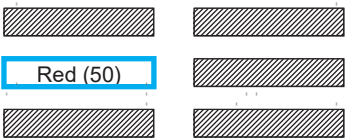
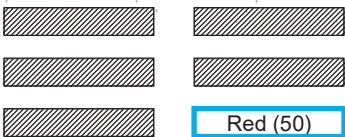
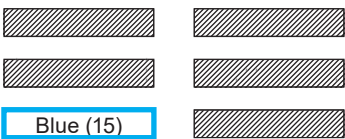
Possible Problems	Usual Solutions
The exhaust fan inside the air outlet ("VENTILATION") does not work.	 <p>Remove the control panel and check the <b>yellow</b> fuse marked with "5" in the <b>upper right</b> socket. If it is burnt out, replace it with its spare (L).</p>
	Have the fan or other related components repaired or replaced.
The left track and wheels do not work.	 <p>Remove the control panel and check the <b>red</b> fuse marked with "50" in the <b>middle left</b> socket. If it is burnt out, replace it with either of its spares (N).</p>
The right track and wheels do not work.	 <p>Remove the control panel and check the <b>red</b> fuse marked with "50" in the <b>lower right</b> socket. If it is burnt out, replace it with either of its spares (N).</p>
The cutter cannot rise or descend.	 <p>Remove the control panel and check the <b>blue</b> fuse marked with "15" in the <b>lower left</b> socket. If it is burnt out, replace it with either of its spares (M).</p>
The digital display shows the battery draining while the engine operates and powers the electric generator.	Have a trained technician inspect and repair the electric generator in the main bay and all the related components in the electrical compartment.

## 8.4 Remote Control

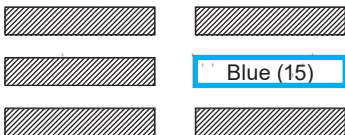
Possible Problem	Usual Solutions
The remote cannot control the mower.	Ensure that <b>BOTH</b> the remote and mower <b>ARE</b> powered on.
	Use the remote control in a location nearer to the mower.
	 <p>Remove the control panel and check the <b>blue</b> fuse marked with “<b>15</b>” in the <b>middle right</b> socket. If it is burnt out, replace it with either of its spares (M).</p>
	Contact your local dealer for a new identical one.

## 9. Disposal



Electrical products should not be disposed of with household products. In the EU and UK, according to the European Directive 2012/19/EU for the disposal of electrical and electronic equipment and its implementation in national laws, used electrical products must be collected separately and disposed of at the collection points provided for this purpose. Locations in Australia, Canada, and the United States may have similar regulations. Contact your local authorities or dealer for disposal and recycling advice.

## Contact Us

Thank you for choosing our products! If you have any questions or comments, contact us at [contact@b2ccsgroup.com](mailto:contact@b2ccsgroup.com) and we'll resolve your issue ASAP!

For a .pdf copy of the latest version of these instructions, use the appropriate app on your smartphone to scan the QR code to the right.

