

**SAMSUNG**



## **Cassette Air Conditioning**

**360 Cassette and WindFree™ 4 Way Cassette**  
Comfortable cool, not unpleasantly cold



## More than a trusted air conditioning solution

At Samsung, we imagine all sorts of innovative ways to improve how your space functions and help it run smoothly – giving you the environment you deserve. We are proud to say Samsung products are designed to be intuitive and to fit seamlessly into your life.

Samsung air conditioners have been designed with the same passion for innovation and quality that has helped make Samsung one of the world's top electronics producers and one of the Interbrand 2021 Best Global Brands.

Samsung air conditioning systems are held in high esteem, used in apartments, housing, shopping centres, airports, stadiums and hotels around the world. Samsung continues to invest heavily in research and development, performance testing and quality control to deliver quality air conditioning systems to market.



\*Source: Interbrand Best Global Brands 2021 rankings.

## Control your climate with intelligent Samsung technology

The Samsung Cassette air conditioning system offers intelligent air flow control, maintaining good comfort control, whilst combining energy efficiency and reliability to deliver outstanding performance in a space-saving design.

### Low GWP refrigerant

Uses the next generation R32 refrigerant, which has an Ozone Depletion Potential (ODP) of zero and lower Global Warming Potential (GWP) than conventional refrigerants.\*

\* Comparing to R410A

### Reliable performance

Reliability is a key factor when choosing an air conditioning system. Samsung air conditioners offers robust design and reliability to help ensure consistent performance.

### Exceptional design and innovation

Samsung system air conditioners are lauded industry wide for their innovative technology and exquisitely beautiful, yet high functioning design. From prestigious institutions and exhibitions across the globe, Samsung units have garnered copious awards, including the Galeria de Innovacion Award, iF Product Design Award, Comfort & Design Award, and Good Design Award.

## Thoughtful design

Samsung has added the new eco-friendly R32 refrigerant to its air conditioning range. Refrigerants are an essential part of air conditioning, and it is important to choose a refrigerant that has a low environmental impact. R32 Refrigerant has a lower Global Warming Potential (GWP)\* of 675 compared to R410A GWP of 2,088. R32 is also a zero Ozone Depletion Potential (ODP) refrigerant- which minimises the effects on the ozone layer.



\*Product images may be different to actual product, product size varies depending on model.



## Maintaining comfort whilst keeping your style

Samsung innovative 360 Cassette and **WindFree™** Cassette technology takes Cassette technology to the next level, not only providing good comfort where you need it when you need it, it also has a neat, tidy look with an aesthetic flair that blends with virtually any ambience.



# 360 Cassette

## Well rounded

A truly circular cassette



Enjoy even airflow from a beautifully sleek design that fits into almost any setting

### Better airflow distribution via omni-directional outlet

The innovative 360 degree airflow provides consistent conditions and minimises hot and cold spots – designed to provide even temperature across the room\*.

### Directional airflow control

360 Cassette features an innovative Booster Fan technology, which enables cool air to be directed at selected angles. The booster fans can be individually set at the same or different angles within a 10-60° range. The swing function is available when all 3 booster fans are operating in unison.

### Bladeless design

Standard 4-Way Ceiling Cassettes use blades on 4 sides of the unit to distribute air. This 4-sided distribution can cause up to 25% reduction in airflow and creates uneven room temperature, resulting in hot and cold spots. With bladeless technology and the use of 3 booster fans, the 360 Cassette provides even, horizontal airflow.

\* Within a 9.3m radius, temperature difference is less than 0.6°C. Actual effect may vary depending on installation environment.



### Style options

The 360 Cassette is offered in both black and white for open-type (circle) and ceiling-type (square) fascia panel options (panel sold separately).

### Easy access

All internal components and field wiring connections are accessible from the bottom of the unit.



## A beautiful circle ensures perfect harmony with your own style

The 360 Cassette is available in a wide range of heating and cooling capacities to fit commercial and light commercial applications. Its innovative circular design can match a multitude of interior designs.

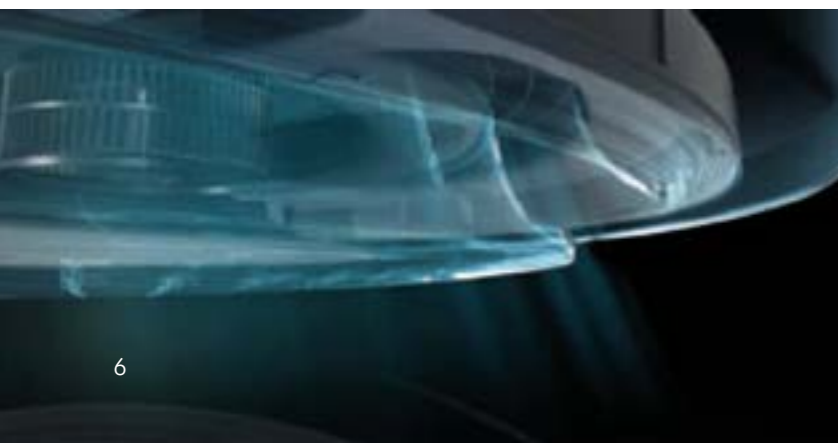

# 360 Cassette

## Hygiene

### Even more comfort with even cleaner air

Staying cool is one thing, but to be really comfortable you also need to be breathing clean air. So the Samsung 360 Cassette incorporates an air purifier that is designed to improve the air quality with its advanced filtration system.

## An air conditioner and an air purifier rolled into just one unit

### Air Purification Panel (PC6EUCMAN)\*

The Samsung 360 Cassette offers an optional Purifying Panel that keeps the indoor air fresh and clean. It consists of 2 types of filter – a Pre-Filter and a PM1.0 Filter. This 2-step filtration system is designed to ensure that you can breathe in pure, fresh air all day long. And its Air Purity Level Display clearly shows the pollution level.

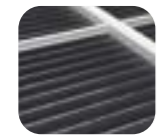

#### PM1.0 Filter

Has an electrostatic charge that gives ultrafine dust, up to 0.3µm in size, a positive charge, so it becomes strongly attached to the ground plates.

PM1.0 Ultrafine particles		PM2.5 Fine particles		PM10 Coarse particles	
Virus	0.005 – 0.3µm	Powder	0.1 – 30µm	Red blood cells	5 – 10µm
Bacteria	0.3 – 60µm	Printer toner	0.5 – 15µm	Car emissions	1 – 150µm
Cigarette smoke	0.001 – 4µm	Atmospheric	0.001 – 40µm	Pollen	6 – 100µm
		House dust	0.05 – 100µm	Hair	5 – 200µm
		Cobweb width	2 – 3µm	Human hair	40 – 300µm
				Sand	62 – 500µm
				Fog	70 – 350µm
				Glass wool	1000µm

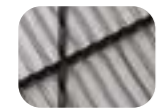

#### Pre-Filter

Blocks large particles, such as household dust, fibers, etc.



#### Korea Air Cleaning Association

The filtration system of Samsung 360 Cassette has been certified by Korea Air Cleaning Association, based on testing using the standard KACA-CAC-2011.

\* Air Purification Panel model PC6EUCMAN is sold separately.

## Keep using for longer with a simple wash

### Washable Filters

The semi-permanent PM1.0 Filter and Pre-Filter are washable and reusable. It means you can continue enjoying clean, fresh air, while also saving on maintenance costs as you don't need to buy new filters.

#### STEP 01/ Wash

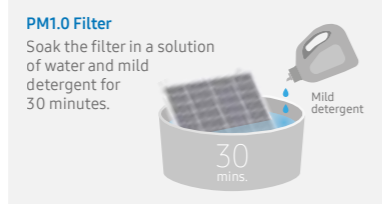
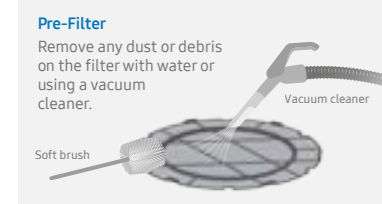

#### STEP 02/ Rinse and Air Dry



## Keeps your air hygienic by capturing dust, airborne contaminants and allergens

### Pre-Filter

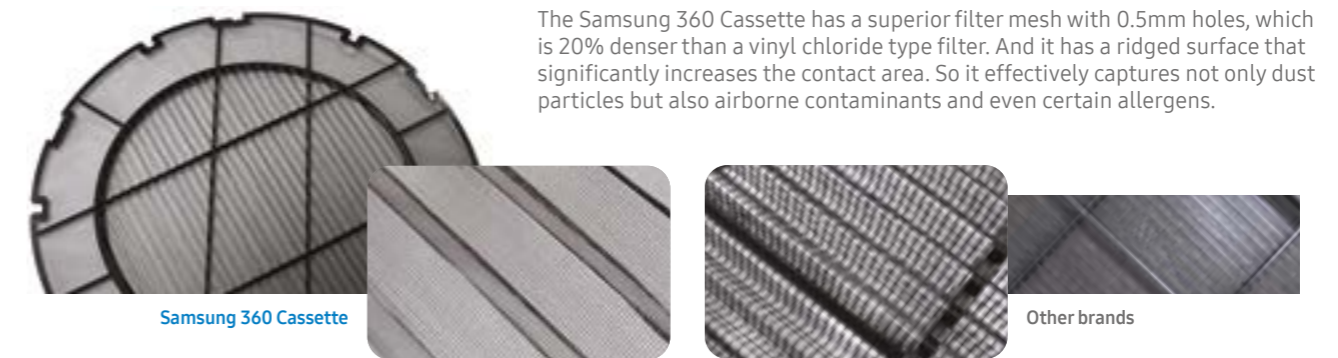

The Samsung 360 Cassette has a superior filter mesh with 0.5mm holes, which is 20% denser than a vinyl chloride type filter. And it has a ridged surface that significantly increases the contact area. So it effectively captures not only dust particles but also airborne contaminants and even certain allergens.

## Proven capability to sterilize bacteria

### PM1.0 Filter

The PM1.0 filter is not only effective at capturing ultrafine dust of up to 0.3µm in size, but it also sterilizes up to 99% of the bacteria trapped by the filter using an electrostatic precipitator. Its effectiveness in sterilizing bacteria has been verified by Intertek\*.

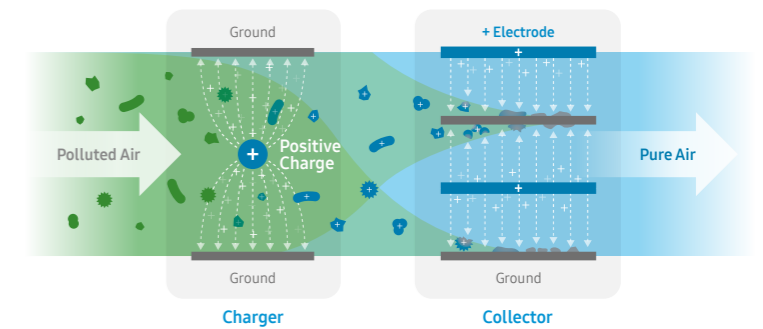

\* Based on the Intertek test report (No.: RT20E-S0010-R).  
Test bacteria: Escherichia coli, Staphylococcus aureus.



“The PM 1.0 filter of Samsung Electronics can sterilize more than 99% of the microorganisms that are collected on the filter.”

Intertek is a British multinational company specializing in product assurance, inspection, testing and certification. This test was rigorously conducted by Intertek, and the test result was reported officially.



#### Test method & measurement

1. Run the air conditioner while operating the PM1.0 Filter using high voltage power and a low fan speed. Spray bacteria towards the filter using a nebulizer, so that the bacteria are captured in the filter.
2. Stop spraying bacteria and keep the filter operating for an additional 10 minutes to allow the sterilization process to happen.
3. Calculate the sterilization rate by comparing the number of bacteria remaining on the filter with the number of bacteria cultivated on the source medium.

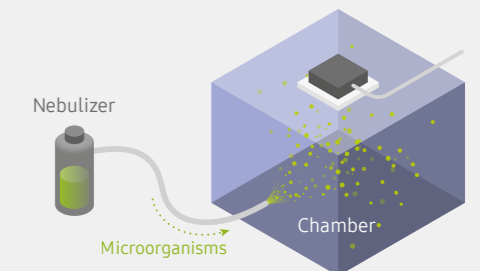

#### Conclusion

More than 99% of the microorganisms, such as Escherichia coli and Staphylococcus aureus, in the PM1.0 filter were destroyed by static electricity.



# 360 Cassette

1-phase, 220-240V, 50Hz

Model	Indoor Unit		AC071TN4PKG/SA	AC100TN4PKG/SA	AC120TN4PKG/SA	AC140TN4PKG/SA
	Outdoor Unit		AC071TXAPKG/SA	AC100TXAPKG/SA	AC120TXAPKG/SA	AC140TXAPKG/SA
Capacity <sup>1</sup>	Refrigerant		R32	R32	R32	R32
	Cooling (Min/Std/Max)	kW	2.00 / 7.10 / 8.00	4.3 / 10.0 / 12.0	4.5 / 12.5 / 14.0	4.7 / 13.6 / 15.5
	Heating (Min/Std/Max)	kW	1.50 / 8.00 / 9.00	3.6 / 11.2 / 15.5	3.8 / 14.0 / 16.2	4.0 / 16.0 / 18.0
Efficiency	Cooling	EER	3.70	3.90	3.52	3.20
	Heating	COP	4.00	3.80	3.50	3.30
	Cooling	AEER	3.69	3.89	3.51	3.19
	Heating	ACOP	3.99	3.78	3.49	3.29
Electrical	Power Supply	Φ, #, V, Hz	1-phase, 220-240V, 50Hz			
	MCA <sup>2</sup>	A	18.0	25.5	33.5	33.5
	MFA	A	20.6	30.0	40.0	40.0
Indoor Unit	Air Flow Rate (H, M, L)	l/s	350/300/250	500/433/367	533/450/383	550/467/400
	Sound Pressure <sup>3</sup> @ 1.5m (H/M/L)	dB(A)	35 / 32 / 28	43 / 37 / 32	44 / 39 / 34	44 / 40 / 36
	Sound Power <sup>4</sup>	dB(A)	53	60	61	61
	Unit Dimensions (WxHxD)	mm	947 x 365 x 947	947 x 365 x 947	947 x 365 x 947	947 x 365 x 947
	Net Weight	kg	23.5	25.5	25.5	25.5
	Drain Pump		Built In	Built In	Built In	Built In
	Drain Lift / Displacement	mm / L/hr	750 / 24	750 / 24	750 / 24	750 / 24
	Drain connection size	mm	OD 32 / ID 25	OD 32 / ID 25	OD 32 / ID 25	OD 32 / ID 25
	Internal unit height from ceiling (Standard installation)	With Circular panel	mm	289	289	289
With Square panel		mm	317	317	317	317
Panel (order separately)	Model (Square, White)		PC4NUDMAN	PC4NUDMAN	PC4NUDMAN	PC4NUDMAN
	Unit Dimensions (WxHxD)	mm	1000 x 66 x 1000	1000 x 66 x 1000	1000 x 66 x 1000	1000 x 66 x 1000
	Net Weight	kg	3.6	3.6	3.6	3.6
	Model (Round, White)		PC4NUNMAN	PC4NUNMAN	PC4NUNMAN	PC4NUNMAN
	Unit Dimensions (WxHxD)	mm	1050Ø x 94H	1050Ø x 94H	1050Ø x 94H	1050Ø x 94H
Air Purification Panel (sold separately)	Model (Round, White)		PC6EUCMAN	PC6EUCMAN	PC6EUCMAN	PC6EUCMAN
	Unit Dimensions (WxHxD)	mm	1050Ø x 102H	1050Ø x 102H	1050Ø x 102H	1050Ø x 102H
	Net Weight	kg	6	6	6	6
Outdoor Unit	Compressor Type		Twin BLDC	Rotary	Rotary	Rotary
	Sound Pressure <sup>3</sup> @ 1m (Cool/Heat)	dB(A)	50 / 52	51 / 53	53 / 55	54 / 56
	Sound Power <sup>4</sup>	dB(A)	66	68	69	70
	Net Weight	kg	51.0	97.5	100.5	100.5
	Shipping weight	kg	55.0	106.5	109.5	109.5
	Unit Dimensions (WxHxD)	mm	880 x 798 x 310	940 x 1420 x 330	940 x 1420 x 330	940 x 1420 x 330
Installation	Liquid Pipe	mm / in	6.35, 1/4"	9.52, 3/8"	9.52, 3/8"	9.52, 3/8"
	Gas Pipe	mm / in	15.8, 5/8"	15.8, 5/8"	15.8, 5/8"	15.8, 5/8"
	Max. Allowable Piping Length	m	50	85	85	85
	Max. Allowable Piping Height	m	30	30	30	30
	Pre-charged Length	m	20	30	30	30
Operating Range	Cooling	°C	-15 to 50	-15 to 50	-15 to 50	-15 to 50
	Heating	°C	-20 to 24	-20 to 24	-20 to 24	-20 to 24

Note: specification may be subject to change without prior notice.

- Capacities are based on (equivalent refrigerant pipe length 5m, Level differences 0m);  
Cooling: Indoor temperature 27°C DB / 19°C WB, Outdoor temperature 35°C DB / 24°C WB  
Heating: Indoor temperature 20°C DB / 15°C WB, Outdoor temperature 7°C DB / 6°C WB
- Select wire size based on the value of MCA and in accordance of local electrical regulation standards.
- Sound pressure level is obtained in an anechoic room, thus actual noise level may be different depending on the installation conditions.
- Sound power level is an absolute value that a sound source generates.  
dBA = A-weighted sound power level. Reference power: 1pW. Measured according to ISO 3741.

### Optional Accessories (sold separately)



Images are for illustration purposes. Product images may be different to actual product, product size varies depending on model.



**Design Award**  
360 Cassette awarded for design excellence.



### Circular Design

Its full-circle design allows it to be placed beautifully to meet your aesthetic interior designs.



### Bladeless

Bladeless design means no louver vanes to obstruct air flow, increasing air flow delivery. The Samsung booster fan design enables directional air flow settings without the need of louver blades.



### Balanced Air Conditioning

Innovative 360 degree airflow provides balanced air conditioning, minimising hot spots and cold spots, contributing to fast and even temperature control.



### LED Display

Circular LED displays airflow direction setting of horizontal and vertical airflow operation.

Model	Type	Finish	Dimensions (mm)	Net Weight (kg)
PC4NUDMAN	Square	White	1000W x 66H x 1000D	3.6
PC4NBDMAN	Square	Black	1000W x 66H x 1000D	3.6
PC4NUNMAN	Circular	White	1050Ø x 66H	2.7
PC4NBNMAN	Circular	Black	1050Ø x 66H	2.7
PC6EUCMAN	Circular - Air Purification	White	1050Ø x 102H	6.0

### Optional Accessories (sold separately)



Images are for illustration purposes. Product images may be different to actual product, product size varies depending on model.

# Samsung's Innovative WindFree™ Technology



Its lack of wind  
will blow you away

Stay comfortably cool  
without feeling cold

WindFree™ Cooling technology maintains the desired temperature and eliminates cold drafts by delivering air through micro holes on the unit's fascia panel when the louvers are closed, producing a dispersed and gentle flow of air defined as "still air." The WindFree™ fascia panel includes a humidity sensor to prevent condensation by restricting WindFree™ operation in high humidity conditions. WindFree™ operation is available in cooling mode only.

\*Creates a "Still Air" environment. ASHRAE defines "Still Air" as air currents at speeds below 0.15m/s which lacks the presence of cold drafts. The device provides cooling at or below this speed in WindFree Cooling mode. Illustration indicative only, actual effect will vary.



# WindFree™\* 4-Way Cassette

Samsung's WindFree™ 4-Way Cassette is the latest in air conditioning innovation. With its specialised blades, adjustable operation and seamless blend of style and utility, the 4-Way Cassette can sustain cooling comfort in a plethora of environments.



<b>15,700</b> Micro Holes WindFree™ 4-Way (840 x 840mm) Cassette	<b>9,000</b> Micro Holes WindFree™ Compact 4-Way (600 x 600mm) Cassette
---	--

## WindFree™\* cooling with micro holes

The WindFree™ 4-Way Cassette pushes air out through 15,700 micro holes in the panel, producing a dispersed and gentle flow called "still air". The uniform air distribution effortlessly keeps a room cool while avoiding the conventional discomfort of cold drafts\*.

\*ASHRAE (American Society of Heating, Refrigeration, and Air-Conditioning Engineers) defines 'Still Air' as air currents at speeds below 0.15m/a which lacks the presence of cold drafts. The device provides cooling below this speed in WindFree Cooling mode.

## Wide cooling range

The large, optimised blades enable a wide cooling range, resulting in good air circulation. In this way, a room can be cooled fast and with limited dead zones.

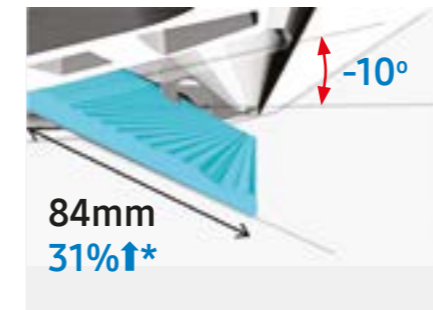

Illustration indicative of modes. Actual effect will vary.

\*Comparing WindFree 4-Way Cassette (840x840mm) to Standard 4-Way Cassette (840x840mm).

## Smart comfort operation

The WindFree™ 4-Way Cassette cools a room to your comfort zone fast, before switching to WindFree™ Cooling mode automatically to help maintain that comfortable temperature.

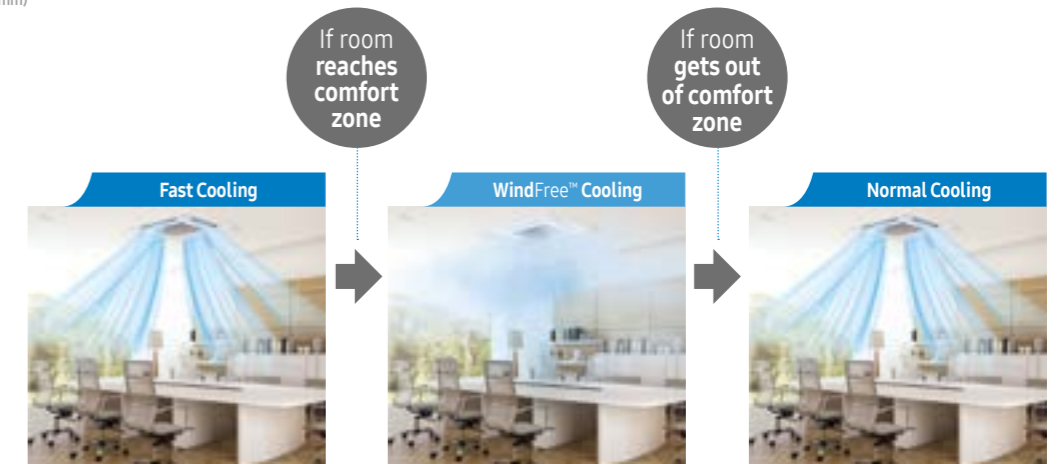

Illustration indicative of modes. Actual effect will vary.

## Hands-free comfort

A 2-Step Cooling system cools air fast in Fast Cooling mode, before automatically switching to WindFree™ Cooling to maintain the desired temperature once it is reached, this way you stay comfortable without a need to change the settings.



Illustration indicative of modes. Actual effect will vary.

\*ASHRAE (American Society of Heating, Refrigeration, and Air-Conditioning Engineers) defines 'Still Air' as air currents at speeds below 0.15m/a which lacks the presence of cold drafts. The device provides cooling below this speed in WindFree Cooling mode.

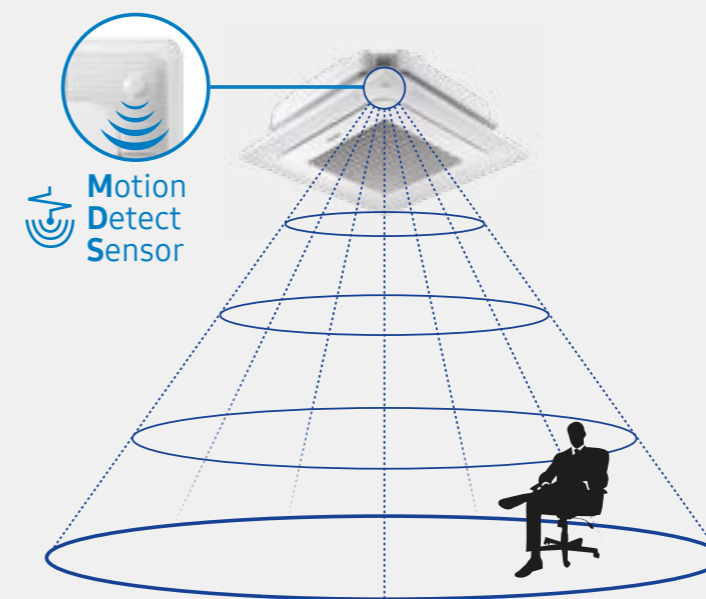

## Motion Detect Sensor (MDS) operation

(Sold separately)

The Motion Detect Sensor (MDS) enables customised air direction and operational efficiency by pinpointing the location of people in a room.



# WindFree™ 4-Way Cassette

## Hygiene

### Even more comfort with even cleaner air

Staying cool is one thing, but to be really comfortable you also need to be breathing clean air. So the Samsung WindFree™ 4-Way Cassette incorporates an air purifier that is designed to improve the air quality with its advanced filtration system.

## An air conditioner and an air purifier rolled into one unit

### Air Purification Panel (PC4NUCEAN)\* Applicable for 840 x 840 Cassette models only

The Samsung WindFree™ 4-Way Cassette not only has a general panel but can also include an optional Purifying Panel that keeps the indoor air fresh and clean. It consists of 2 steps of filter – a PreFilter and a PM1.0 Filter. This 2-step filtration system is designed to ensure that you can breathe in pure, fresh air all day long.

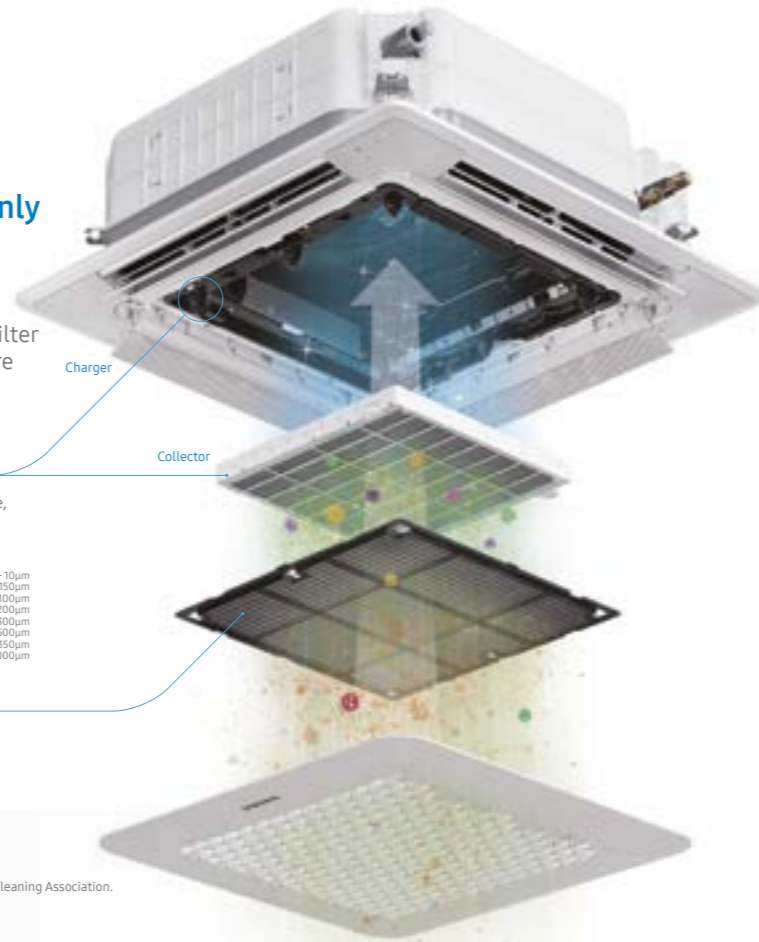

#### PM1.0 Filter

Has an electrostatic charger that gives ultrafine dust, up to 0.3µm in size, a negative charge, so it becomes strongly attached to the ground plates.

PM1.0 Ultrafine particles		PM2.5 Fine particles		PM10 Coarse particles	
Virus	0.005 – 0.3µm	Powder	0.1 – 30µm	Red blood cells	5 – 10µm
Bacteria	0.3 – 60µm	Printer toner	0.5 – 15µm	Car emissions	1 – 150µm
Cigarette smoke	0.001 – 4µm	Atmospheric	0.001 – 40µm	Pollen	6 – 100µm
		House dust	0.05 – 100µm	Hair	5 – 200µm
		Cobweb width	2 – 3µm	Human hair	40 – 300µm
				Sand	62 – 500µm
				Fog	70 – 350µm
				Glass wool	1000µm



#### Pre-Filter

Blocks large particles, such as household dust, fibers, etc.



#### Korea Air Cleaning Association

The filtration system of the WindFree™ 4Way Cassette has been certified by the Korea Air Cleaning Association. Based on testing using the standard KACA-CAC-2011.

\*Air Purification Panel model PC4NUCEAN is sold separately.

## Keep using for longer with a simple wash

### Washable Filters

The semi-permanent PM1.0 Filter and Pre-Filter are washable and reusable. It means you can continue enjoying clean, fresh air, while also saving on maintenance costs as you don't need to buy new filters.

#### STEP 01/ Wash

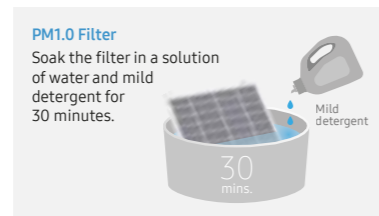

#### STEP 02/ Rinse and Air Dry



## Proven capability to sterilize bacteria as well as capturing ultrafine dust

### PM1.0 Filter

The PM1.0 filter is not only effective at capturing ultrafine dust of up to 0.3µm in size, but it also sterilizes up to 99% of the bacteria trapped by the filter using an electrostatic precipitator. It has two main parts that charge and collect dust and bacteria. The brush discharger generates negative ions. And these give the dust particles and bacteria a negative charge, so they become strongly attached to the ground electrode due to the electrostatic force of the collector. Its effectiveness in sterilizing bacteria has been verified by Intertek\*.

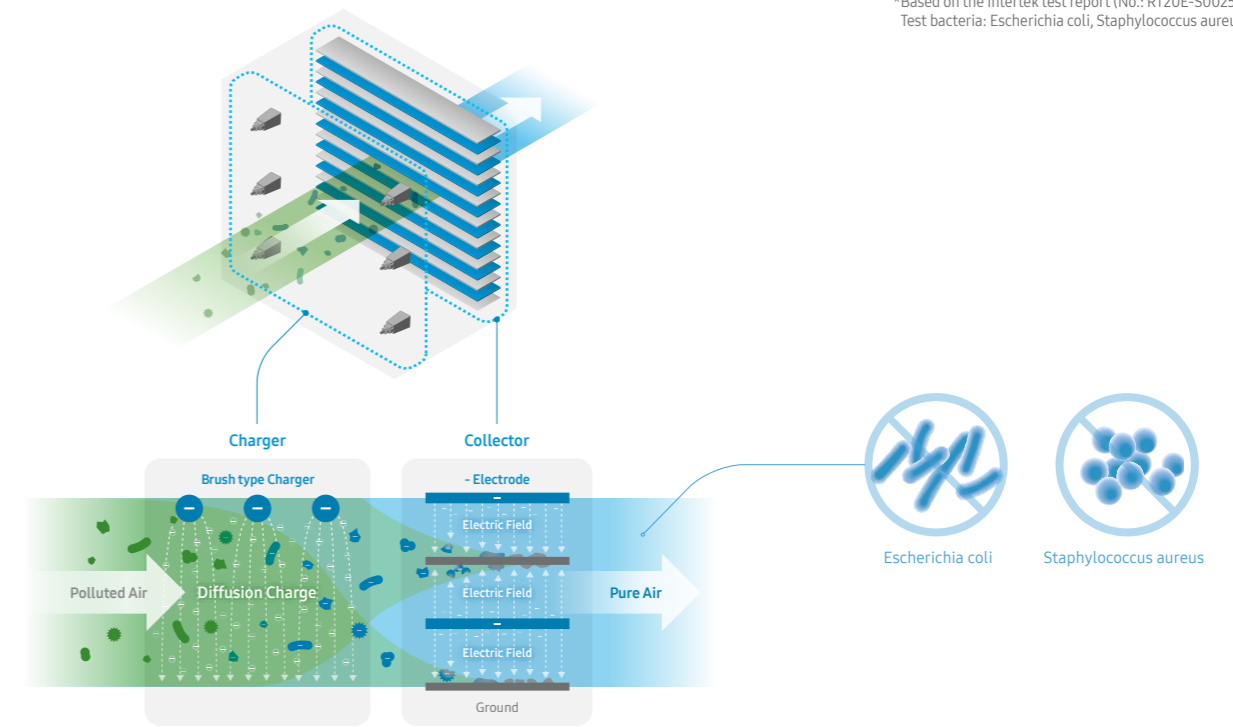

\*Based on the Intertek test report (No.: RT20E-S0025).  
Test bacteria: Escherichia coli, Staphylococcus aureus.



“The PM 1.0 filter of Samsung Electronics can sterilize more than 99% of the microorganisms that are collected on the filter.”

Intertek is a British multinational company specializing in product assurance, inspection, testing and certification. This test was rigorously conducted by Intertek, and the test result was reported officially.



#### Test method & measurement

1. Run the air conditioner while operating the PM1.0 Filter using high voltage power and a low fan speed. Spray bacteria towards the filter using a nebulizer, so that the bacteria are captured in the filter.
2. Stop spraying bacteria and keep the filter operating for an additional 10 minutes to allow the sterilization process to happen.
3. Calculate the sterilization rate by comparing the number of bacteria remaining on the filter with the number of bacteria cultivated on the source medium.

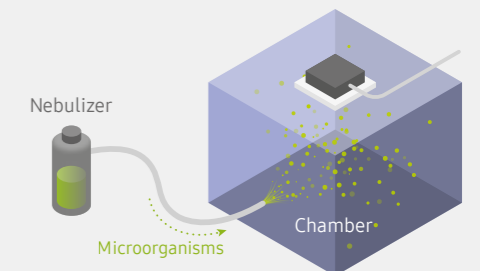

#### Conclusion

More than 99% of the microorganisms, such as Escherichia coli and Staphylococcus aureus, in the PM1.0 filter were destroyed by static electricity.



# WindFree™ 4 Way Cassette (840 x 840)

1-phase, 220-240V, 50Hz



Model	Indoor Unit		AC071TN4DKG/SA	AC100TN4DKG/SA	AC120TN4DKG/SA	AC140TN4DKG/SA
	Outdoor Unit		AC071TXAPKG/SA	AC100TXAPKG/SA	AC120TXAPKG/SA	AC140TXAPKG/SA
Capacity <sup>1</sup>	Refrigerant		R32	R32	R32	R32
	Cooling (Min/Std/Max)	kW	2.00 / 7.10 / 8.00	4.3 / 10.0 / 12.0	4.5 / 12.5 / 14.0	4.7 / 14.0 / 15.5
	Heating (Min/Std/Max)	kW	1.50 / 8.00 / 9.00	3.6 / 11.2 / 15.5	3.8 / 14.0 / 16.2	4.0 / 16.0 / 18.0
Efficiency	Cooling	EER	3.70	3.90	3.52	3.20
	Heating	COP	4.00	3.90	3.50	3.30
	Cooling	AEER	3.69	3.89	3.51	3.19
	Heating	ACOP	3.99	3.89	3.49	3.29
Electrical	Power Supply	Φ, #, V, Hz	1-phase, 220-240V, 50Hz			
	MCA <sup>2</sup>	A	18.0	25.5	33.5	33.5
	MFA	A	20.6	30.0	40.0	40.0
Indoor Unit	Air Flow Rate (H, M, L)	l/s	367/317/267	517/417/317	517/417/333	533/433/350
	Sound Pressure <sup>3</sup> @ 1.5m (H/M/L)	dB(A)	35 / 32 / 28	43 / 37 / 32	44 / 39 / 34	44 / 40 / 36
	Sound Power <sup>4</sup>	dB(A)	53	60	61	61
	Net Weight	kg	18	20	20	20
	Unit Dimensions (WxHxD)	mm	840 x 288 x 840	840 x 288 x 840	840 x 288 x 840	840 x 288 x 840
	Drain Pump		Built-in	Built-in	Built-in	Built-in
	Drain Lift / Displacement	mm / (L/hr)	750 / 24	750 / 24	750 / 24	750 / 24
	Drain connection size	mm	OD 32 / ID 25	OD 32 / ID 25	OD 32 / ID 25	OD 32 / ID 25
	Panel (Sold Separately)	Model		PC4NUFMAN	PC4NUFMAN	PC4NUFMAN
Type			Wind-Free	Wind-Free	Wind-Free	Wind-Free
Net Weight		kg	6.3	6.3	6.3	6.3
Air Purification Panel (sold separately)	Model		PC4NUCEAN	PC4NUCEAN	PC4NUCEAN	PC4NUCEAN
	Unit Dimensions (WxHxD)	mm	950 x 48 x 950	950 x 48 x 950	950 x 48 x 950	950 x 48 x 950
	Net Weight	kg	9.4	9.4	9.4	9.4
Outdoor Unit	Compressor Type		Twin BLDC Rotary	Twin BLDC Rotary	Twin BLDC Rotary	Twin BLDC Rotary
	Sound Pressure <sup>3</sup> @ 1m (Cool/Heat)	dB(A)	50 / 52	51 / 53	53 / 55	54 / 56
	Sound Power <sup>4</sup>	dB(A)	66	68	69	70
	Net Weight	kg	51.0	97.5	100.5	100.5
	Net Dimensions (WxHxD)	mm	880 x 798 x 310	940 x 1420 x 330	940 x 1420 x 330	940 x 1420 x 330
Installation	Liquid Pipe	mm / in	6.35, 1/4"	9.52, 3/8"	9.52, 3/8"	9.52, 3/8"
	Gas Pipe	mm / in	15.8, 5/8"	15.8, 5/8"	15.8, 5/8"	15.8, 5/8"
	Max. Allowable Piping Length	m	50	85	85	85
	Max. Allowable Piping Height	m	30	30	30	30
	Pre-charged Length	m	20	30	30	30
Operating Range	Cooling	°C	-15 to 50	-15 to 50	-15 to 50	-15 to 50
	Heating	°C	-20 to 24	-20 to 24	-20 to 24	-20 to 24

Note: specification may be subject to change without prior notice.

- Capacities are based on (equivalent refrigerant pipe length 5m, Level differences 0m);  
Cooling: Indoor temperature 27°C DB / 19°C WB, Outdoor temperature 35°C DB / 24°C WB  
Heating: Indoor temperature 20°C DB / 15°C WB, Outdoor temperature 7°C DB / 6°C WB
- Select wire size based on the value of MCA and in accordance of local electrical regulation standards.

- Sound pressure level is obtained in an anechoic room, thus actual noise level may be different depending on the installation conditions.
- Sound power level is an absolute value that a sound source generates.  
dBA = A-weighted sound power level. Reference power: 1pW. Measured according to ISO 3741.

### Optional Accessories (Sold Separately)



Images are for illustration purposes. Product images may be different to actual product, product size varies depending on model.



# WindFree™ 4 Way Cassette (600 x 600)

1-phase, 220-240V, 50Hz



Model	Indoor Unit		AC026TNNDKG/SA	AC035TNNDKG/SA	AC052TNNDKG/SA	AC060TNNDKG/SA
	Outdoor Unit		AC026TXAPKG/SA	AC035TXAPKG/SA	AC052TXAPKG/SA	AC060TXAPKG/SA
Capacity <sup>1</sup>	Refrigerant		R32	R32	R32	R32
	Cooling (Min/Std/Max)	kW	0.99 / 2.60 / 3.50	0.99 / 3.50 / 4.20	1.30 / 5.00 / 5.90	1.80 / 5.80 / 6.50
	Heating (Min/Std/Max)	kW	0.98 / 3.30 / 4.60	0.98 / 4.00 / 5.00	1.30 / 5.50 / 7.50	1.60 / 6.40 / 9.00
Efficiency	Cooling	EER	4.40	3.70	3.30	3.17
	Heating	COP	3.90	3.69	3.30	3.17
	Cooling	AEER	4.38	3.67	3.28	3.16
	Heating	ACOP	3.87	3.69	3.29	3.16
Electrical	Power Supply	Φ, #, V, Hz	1-phase, 220-240V, 50Hz			
	MCA <sup>2</sup>	A	11.5	11.5	18.0	18.0
	MFA	A	12.7	12.7	20.6	20.6
Indoor Unit	Air Flow Rate (H, M, L) - Cooling	l/s	148/125/108	157/133/100	175/157/125	180/158/133
	Air Flow Rate (H, M, L) - Heating	l/s	155/133/107	158/140/107	188/170/138	200/180/155
	Sound Pressure <sup>3</sup> @ 1.5m (H/M/L)	dB(A)	32 / 29 / 26	35 / 30 / 26	39 / 35 / 30	41 / 37 / 32
	Sound Power <sup>4</sup>	dB(A)	50	51	53	55
	Net Weight	kg	11.8	11.8	12.0	12.0
	Unit Dimensions (WxHxD)	mm	575 x 250 x 575	575 x 250 x 575	575 x 250 x 575	575 x 250 x 575
	Drain Pump		Built-in	Built-in	Built-in	Built-in
	Drain Lift / Displacement	mm / (L/hr)	750 / 24	750 / 24	750 / 24	750 / 24
	Drain connection size	mm	OD 32 / ID 25	OD 32 / ID 25	OD 32 / ID 25	OD 32 / ID 25
Panel (Sold Separately)	Model		PC4SUFMAN	PC4SUFMAN	PC4SUFMAN	PC4SUFMAN
	Type		Wind-Free	Wind-Free	Wind-Free	Wind-Free
	Net Weight	kg	2.7	2.7	2.7	2.7
Outdoor Unit	Compressor Type		Single BLDC Rotary	Single BLDC Rotary	Twin BLDC Rotary	Twin BLDC Rotary
	Sound Pressure <sup>3</sup> @ 1m (Cool/Heat)	dB(A)	46 / 47	47 / 48	49 / 49	49 / 49
	Sound Power <sup>4</sup>	dB(A)	59	60	63	63
Installation	Liquid Pipe	mm / in	6.35, 1/4"	6.35, 1/4"	6.35, 1/4"	6.35, 1/4"
	Gas Pipe	mm / in	9.52, 3/8"	9.52, 3/8"	15.8, 5/8"	15.8, 5/8"
	Max. Allowable Piping Length	m	20	20	50	50
	Max. Allowable Piping Height	m	15	15	30	30
	Pre-charged Length	m	20	20	20	20
Operating Range	Cooling	°C	-15 to 46	-15 to 46	-15 to 50	-15 to 50
	Heating	°C	-20 to 24	-20 to 24	-20 to 24	-20 to 24

Note: specification may be subject to change without prior notice.

- Capacities are based on (equivalent refrigerant pipe length 5m, Level differences 0m);  
Cooling: Indoor temperature 27°C DB / 19°C WB, Outdoor temperature 35°C DB / 24°C WB  
Heating: Indoor temperature 20°C DB / 15°C WB, Outdoor temperature 7°C DB / 6°C WB
- Select wire size based on the value of MCA and in accordance of local electrical regulation standards.

- Sound pressure level is obtained in an anechoic room, thus actual noise level may be different depending on the installation conditions.
- Sound power level is an absolute value that a sound source generates.  
dBA = A-weighted sound power level. Reference power: 1pW. Measured according to ISO 3741.

### Optional Accessories (Sold Separately)



Images are for illustration purposes. Product images may be different to actual product, product size varies depending on model.

# Controls to meet your needs

(All controllers shown are sold separately)



## MWR-WG00JN

### UX Wired Controller



- 4.3" colour LCD display
- Simple navigational control panel
- On/Off, operation mode, fan speed, temperature setting
- Dual set point available
- Energy usage monitoring
- Cassette louver individual blade control
- **WindFree™** and 360 cassette function control
- Filter cleaning alert indicator
- Group control up to 16 indoor units
- Real-time clock
- After hour operational time setting
- Programmable yearly scheduling and holiday scheduling
- Built-in wireless receiver, can receive signal from wireless controller
- Button restriction function
- Built-in room temperature sensor
- Dimensions: 120W x 120H x 19D mm

## MWR-WE13N

### Wired Controller



- Touch button with LCD Backlight
- On/Off, operation mode, fan speed, temperature setting
- Cassette louver individual blade control
- **WindFree™** and 360 cassette function control
- Filter cleaning alert indicator
- Group control up to 16 indoor units
- Real-time clock
- Energy saving control
- Weekly operation schedule setting
- Button restriction function
- Built-in room temperature sensor
- Dimensions: 120W x 124H x 19.5D mm

Images are for illustration purposes. Product images may be different to actual product, product size varies depending on model. Control functions will vary depending on product and model, not all features shown are applicable, refer to specific product user manual for more information.

## MWR-SH11N

### LED Touch Screen Wired Controller



- Touch screen display with backlight
- Simple functionality control
- On/Off, operation mode, fan speed, temperature setting
- **WindFree™** function control
- Outing function; maintains room at preset conditions
- On/Off count down timer
- Button restriction function
- Group control up to 16 indoor units
- Filter cleaning alert indicator
- Built-in wireless receiver, can receive signal from wireless controller
- Built-in room temperature sensor
- Dimensions: 94W x 122H x 19.5D mm

## AR-EH03E

### Wireless Controller



- On/Off, operation mode, fan speed, temperature setting
- Simple On/Off timer
- Filter cleaning alert indicator
- **WindFree™** function control
- Indoor unit option code setting
- Dimension 48W x 138H x 24D mm

## AR-KH03E

### Wireless Controller 360 Cassette



- For use with 360 Cassette indoor unit
- Jog shuttle and button to adjust airflow
- Fast and intuitive navigation
- On/Off, operation mode, fan speed, temperature setting
- Simple On/Off timer
- Filter cleaning alert indicator
- **WindFree™** function
- Indoor unit option code setting
- Dimension 55W x 166H x 28D mm

## MIM-B14

### External Contact Interface Card



External Contact Control module to control an indoor unit (On/Off) via 0V dry contact.

- Direct indoor unit control by external contact signal
- Window-synchronised indoor unit control
- Emergency control with simple contact input
- Indoor unit operation/error state output through relay contacts
- Dimensions: 50W x 80H x 35D mm

Images are for illustration purposes. Product images may be different to actual product, product size varies depending on model. Control functions will vary depending on product and model, not all features shown are applicable, refer to specific product user manual for more information.

## WiFi Controller

### Enjoy remote connectivity with an App

Samsung SmartThings App\* helps you to centrally control your Samsung TV, appliances and other compatible smart devices. You can easily check the list of connected compatible devices, name and status with the App.

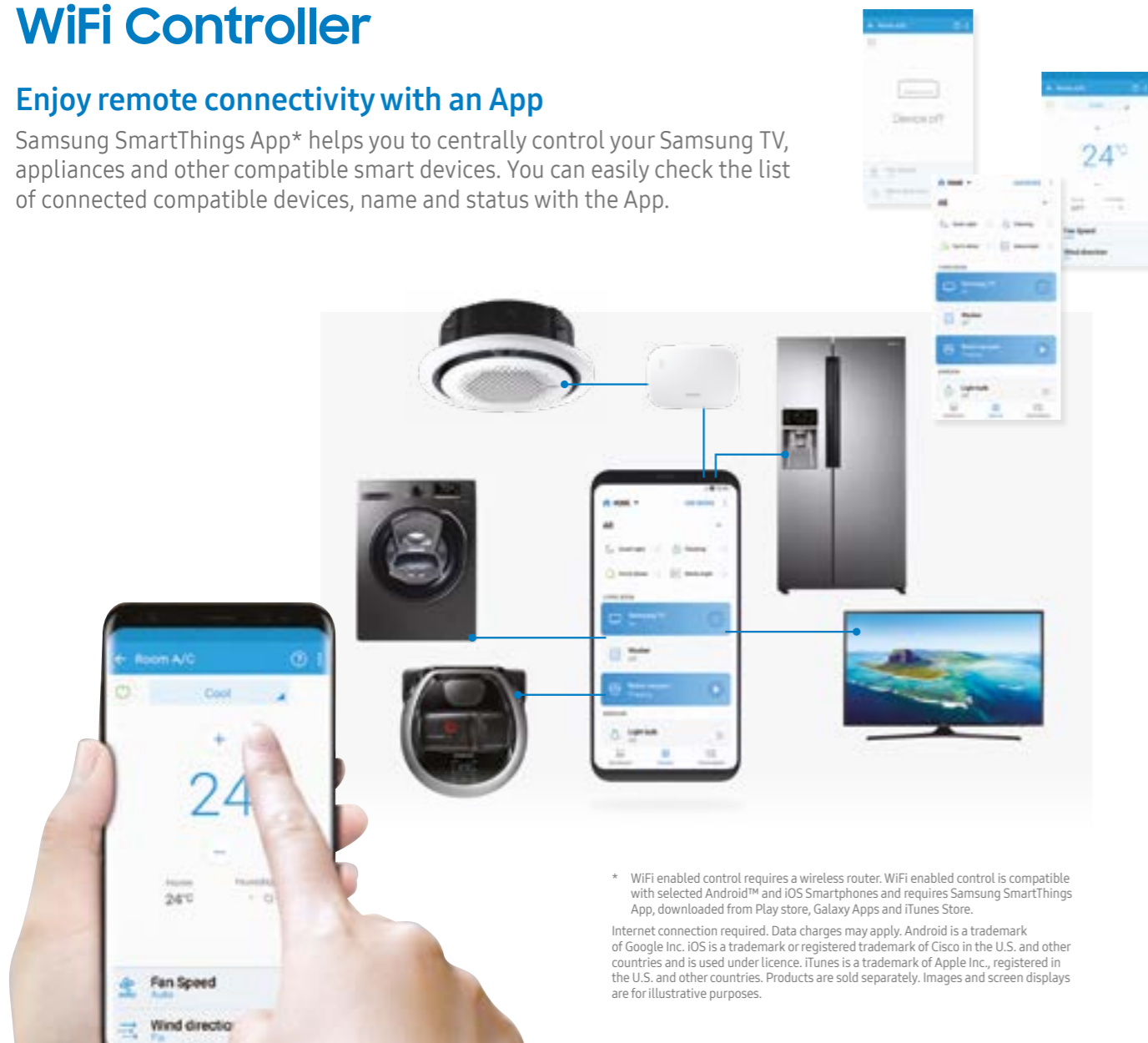

\* WiFi enabled control requires a wireless router. WiFi enabled control is compatible with selected Android™ and iOS Smartphones and requires Samsung SmartThings App, downloaded from Play store, Galaxy Apps and iTunes Store.

Internet connection required. Data charges may apply. Android is a trademark of Google Inc. iOS is a trademark or registered trademark of Cisco in the U.S. and other countries and is used under licence. iTunes is a trademark of Apple Inc., registered in the U.S. and other countries. Products are sold separately. Images and screen displays are for illustrative purposes.

### MIM-H04AN

#### WiFi Controller Kit (Sold separately)

- Enhanced convenience, control and monitor your air conditioning remotely
- Voice Control available through a smartphone with Bixby
- Connected home with affordable units in every home using SmartThings
- Welcome home cooling and heating based on Geo-fencing
- Personalized Climate Environment
- Multi-device experience interoperable with smart appliances
- Weekly operation schedule setting
- Energy Usage Monitoring
- Individually control up to 16 indoor units
- Dimensions: 185W x 130H x 29D mm

Images are for illustration purposes.  
Product images may be different to actual product, product size varies depending on model.

## Central Control



### MCM-A300N

#### Touch Central Controller



- 7 inch Touch LCD display
- Large display with backlight
- On/Off, operation mode, fan speed, temperature setting
- Energy usage monitoring
- Upper and lower temperature limit setting
- Programmable weekly scheduling and holiday scheduling
- Local control and function lock permission setting
- Real-time clock
- Control up to 128 indoor units individually
- Group/zone control, control up to 12 zones
- Digital input terminal for fire emergency shutdown
- Monitor individual indoor unit status and fault history
- Dimensions: 205W x 163H x 38D mm

Images are for illustration purposes.  
Product images may be different to actual product, product size varies depending on model.

# SAMSUNG

## Samsung Air Conditioning is committed to providing you peace of mind with After Sales and Warranty Support



### 5 year warranty on parts and labour

We have you covered with Samsung's 5 years parts and labour warranty for residential application of products featured in this brochure. Refer to the warranty card included with your product for full details.\*



### Product Support Line

If you have any concerns about your product simply call **1300 362 603** and our friendly staff will assist with your enquiry and book a service call if required.



### MEPS compliant

All Samsung air conditioners sold in Australia meet Minimum Energy Performance Standards (MEPS) as set by the Australian Government.



### National Samsung service network

Our extensive national repairer network and dedicated Service Centres are on hand to give you any product support you need. We'll make sure we get your air conditioning back up and running fast with extensive spare parts available across Australia.



### R32 Refrigerant

R32 refrigerant is a zero Ozone Depletion Potential (ODP) refrigerant which reduces the effects on the ozone layer.

\* This is in addition to the rights of consumers under consumer guarantees pursuant to the Australian Consumer Law

To learn more about  
**Samsung Cassette Air Conditioning Systems**  
Go to [www.samsung.com/au/business/air-conditioners/cassette/](http://www.samsung.com/au/business/air-conditioners/cassette/)

Samsung Electronics Australia Pty Ltd  
ABN 63 002 915 648  
3 Murray Rose Avenue  
Homebush Bay NSW 2127 Australia  
NOVEMBER 2021