



**INSTALLATION AND SETUP GUIDE**  
**VERSION 2.2**

**SENSAPHONE<sup>®</sup>**  
REMOTE MONITORING SOLUTIONS

Every effort has been made to ensure that the information in this document is complete, accurate and up-to-date. Sensaphone assumes no responsibility for the results of errors beyond its control. Sensaphone also cannot guarantee that changes in equipment made by other manufacturers, and referred to in this manual, will not affect the applicability of the information in this manual.

Copyright © 2015 by SENSAPHONE®

First Edition, version 2.2, May 2017

Written and produced by SENSAPHONE®.

Please address comments on this publication to:

SENSAPHONE®

901 Tryens Road

Aston, PA 19014

# Important Safety Instructions

Your Sentinel has been carefully designed to give you years of safe, reliable performance. As with all electrical equipment, however, there are a few basic precautions you should take to avoid hurting yourself or damaging the unit:

- Read the installation and operating instructions in this guide carefully. Be sure to save it for future reference.
- Read and follow all warning and instruction labels on the product itself.
- To protect the Sentinel from overheating, make sure all openings on the unit are not blocked. Do not place on or near a heat source, such as a radiator or heat register.
- Do not use your Sentinel near water, or spill liquid of any kind into it.
- Be certain that your power source matches the rating in the specifications of this manual. If you're not sure of the type of power supply to your facility, consult your dealer or local power company.
- Do not allow anything to rest on the power cord. Do not locate this product where the cord will be abused by persons walking on it.
- Do not overload wall outlets and extension cords, as this can result in the risk of fire or electric shock.
- Never push objects of any kind into this product through ventilation holes as they may touch dangerous voltage points or short out parts that could result in a risk of fire or electric shock.
- To reduce the risk of electric shock, do not disassemble this product, but return it to Sensaphone Customer Service, or another approved repair facility, when any service or repair work is required. Opening or removing covers may expose you to dangerous voltages or other risks. Incorrect reassembly can cause electric shock when the unit is subsequently used.
- If anything happens that indicates that your Sentinel is not working properly or has been damaged, unplug it immediately and follow the procedures in the manual for having it serviced. Return the unit for servicing under the following conditions:
  1. The power cord or plug is frayed or damaged.
  2. Liquid has been spilled into the product or it has been exposed to water.
  3. The unit has been dropped, or the enclosure is damaged.
  4. The unit doesn't function normally when you're following the operating instructions.
- To reduce the risk of fire or injury to persons, read and follow these instructions:
  1. Use only the specified type and size battery.
  2. Do not dispose of the battery in a fire. The cell may explode. Check with local codes for possible special disposal instructions.
  3. Do not open or mutilate batteries. Released electrolyte is corrosive and may cause damage to the eyes or skin. It may be toxic if swallowed.
  4. Exercise care in handling batteries in order not to short the battery with conducting materials such as rings, bracelets, and keys. The battery or conductor may overheat and cause burns.
  5. Remove main power connections before replacing the battery.

**FCC Requirements**

Part 15: This equipment has been tested and found to comply with the limits for a Class A digital device, pursuant to Part 15 of the FCC Rules. These limits are designed to provide reasonable protection against harmful interference when the equipment is operated in a commercial environment. This equipment generates, uses and can radiate radio frequency energy and, if not installed and used in accordance with the instructions, may cause harmful interference to radio communications. Operation of this equipment in a residential area is likely to cause harmful interference in which case the user will be required to correct the interference at his own expense.

## 2 YEAR LIMITED WARRANTY

PLEASE READ THIS WARRANTY CAREFULLY BEFORE USING THE PRODUCT.

THIS LIMITED WARRANTY CONTAINS SENSAPHONE'S STANDARD TERMS AND CONDITIONS. WHERE PERMITTED BY THE APPLICABLE LAW, BY KEEPING YOUR SENSAPHONE PRODUCT BEYOND THIRTY (30) DAYS AFTER THE DATE OF DELIVERY, YOU FULLY ACCEPT THE TERMS AND CONDITIONS SET FORTH IN THIS LIMITED WARRANTY.

IN ADDITION, WHERE PERMITTED BY THE APPLICABLE LAW, YOUR INSTALLATION AND/OR USE OF THE PRODUCT CONSTITUTES FULL ACCEPTANCE OF THE TERMS AND CONDITIONS OF THIS LIMITED WARRANTY (HEREINAFTER REFERRED TO AS "LIMITED WARRANTY OR WARRANTY"). IF YOU DO NOT AGREE TO THE TERMS AND CONDITIONS THIS WARRANTY, INCLUDING ANY LIMITATIONS OF WARRANTY, INDEMNIFICATION TERMS OR LIMITATION OF LIABILITY, THEN YOU SHOULD NOT USE THE PRODUCT AND SHOULD RETURN IT TO THE SELLER FOR A REFUND OF THE PURCHASE PRICE. THE LAW MAY VARY BY JURISDICTION AS TO THE APPLICABILITY OF YOUR INSTALLATION OR USE ACTUALLY CONSTITUTING ACCEPTANCE OF THE TERMS AND CONDITIONS HEREIN AND AS TO THE APPLICABILITY OF ANY LIMITATION OF WARRANTY, INDEMNIFICATION TERMS OR LIMITATIONS OF LIABILITY.

- 1. WARRANTOR:** IN THIS WARRANTY, WARRANTOR SHALL MEAN "DEALER, DISTRIBUTOR, AND/OR MANUFACTURER."
- 2. ELEMENTS OF WARRANTY:** THIS PRODUCT IS WARRANTED TO BE FREE FROM DEFECTS IN MATERIALS AND CRAFTSMANSHIP WITH ONLY THE LIMITATIONS AND EXCLUSIONS SET OUT BELOW.
- 3. WARRANTY AND REMEDY:** TWO-YEAR WARRANTY — IN THE EVENT THAT THE PRODUCT DOES NOT CONFORM TO THIS WARRANTY AT ANY TIME DURING THE TIME OF TWO YEARS FROM ORIGINAL PURCHASE, WARRANTOR WILL REPAIR THE DEFECT AND RETURN IT TO YOU AT NO CHARGE.

THIS WARRANTY SHALL TERMINATE AND BE OF NO FURTHER EFFECT AT THE TIME THE PRODUCT IS: (1) DAMAGED BY EXTRANEOUS CAUSE SUCH AS FIRE, WATER, LIGHTNING, ETC. OR NOT MAINTAINED AS REASONABLE AND NECESSARY; OR (2) MODIFIED; OR (3) IMPROPERLY INSTALLED; OR (4) MISUSED; OR (5) REPAIRED OR SERVICED BY SOMEONE OTHER THAN WARRANTORS' AUTHORIZED PERSONNEL OR SOMEONE EXPRESSLY AUTHORIZED BY WARRANTOR'S TO MAKE SUCH SERVICE OR REPAIRS; (6) USED IN A MANNER OR PURPOSE FOR WHICH THE PRODUCT WAS NOT INTENDED; OR (7) SOLD BY ORIGINAL PURCHASER.

LIMITED WARRANTY, LIMITATION OF DAMAGES AND DISCLAIMER OF LIABILITY FOR DAMAGES: THE WARRANTOR'S OBLIGATION UNDER THIS WARRANTY IS LIMITED TO REPAIR OR REPLACEMENT OF THE PRODUCT, AT THE WARRANTOR'S OPTION AS TO REPAIR OR REPLACEMENT. IN NO EVENT SHALL WARRANTORS BE LIABLE OR RESPONSIBLE FOR PAYMENT OF ANY INCIDENTAL, CONSEQUENTIAL, SPECIAL AND/OR PUNITIVE DAMAGES OF ANY KIND, INCLUDING BUT NOT LIMITED TO ANY LABOR COSTS, PRODUCT COSTS, LOST REVENUE, BUSINESS INTERRUPTION LOSSES, LOST PROFITS, LOSS OF BUSINESS, LOSS OF DATA OR INFORMATION, OR FINANCIAL LOSS, FOR CLAIMS OF ANY NATURE, INCLUDING BUT NOT LIMITED TO CLAIMS IN CONTRACT, BREACH OF WARRANTY OR TORT, AND WHETHER OR NOT CAUSED BY WARRANTORS' NEGLIGENCE. IN THE EVENT THAT IT IS DETERMINED IN ANY ADJUDICATION THAT THE LIMITED WARRANTIES OF REPAIR OR REPLACEMENT ARE INAPPLICABLE, THEN THE PURCHASER'S SOLE REMEDY SHALL BE PAYMENT TO THE PURCHASER OF THE ORIGINAL COST OF THE PRODUCT, AND IN NO EVENT SHALL WARRANTORS BE LIABLE OR RESPONSIBLE FOR PAYMENT OF ANY INCIDENTAL, CONSEQUENTIAL, SPECIAL AND/OR PUNITIVE DAMAGES OF ANY KIND, INCLUDING BUT NOT LIMITED TO ANY LOST REVENUE, BUSINESS INTERRUPTION LOSSES, LOST PROFITS, LOSS OF BUSINESS, LOSS OF DATA OR INFORMATION, OR FINANCIAL LOSS, FOR CLAIMS OF ANY NATURE, INCLUDING BUT NOT LIMITED TO CLAIMS IN CONTRACT, BREACH OF WARRANTY OR TORT, AND WHETHER OR NOT CAUSED BY WARRANTORS' NEGLIGENCE.

WITHOUT WAIVING ANY PROVISION IN THIS LIMITED WARRANTY, IF A CIRCUMSTANCE ARISES WHERE WARRANTORS ARE FOUND TO BE LIABLE FOR ANY LOSS OR DAMAGE ARISING OUT OF MISTAKES, NEGLIGENCE, OMISSIONS, INTERRUPTIONS, DELAYS, ERRORS OR DEFECTS IN WARRANTORS' PRODUCTS OR SERVICES, SUCH LIABILITY SHALL NOT EXCEED THE TOTAL AMOUNT PAID BY THE CUSTOMER FOR WARRANTORS' PRODUCT AND SERVICES OR \$250.00, WHICHEVER IS GREATER. YOU HEREBY RELEASE WARRANTORS FROM ANY AND ALL OBLIGATIONS, LIABILITIES AND CLAIMS IN EXCESS OF THIS LIMITATION.

INDEMNIFICATION AND COVENANT NOT TO SUE: YOU WILL INDEMNIFY, DEFEND AND HOLD HARMLESS WARRANTORS, THEIR OWNERS, DIRECTORS, OFFICERS, EMPLOYEES, AGENTS, SUPPLIERS OR AFFILIATED COMPANIES, AGAINST ANY AND ALL CLAIMS, DEMANDS OR ACTIONS BASED UPON ANY LOSSES, LIABILITIES, DAMAGES OR COSTS, INCLUDING BUT NOT LIMITED TO DAMAGES THAT ARE DIRECT OR INDIRECT, INCIDENTAL, SPECIAL OR CONSEQUENTIAL, AND INCLUDING ATTORNEYS FEES AND LEGAL COSTS, THAT MAY RESULT FROM THE INSTALLATION, OPERATION, USE OF, OR INABILITY TO USE WARRANTORS' PRODUCTS AND SERVICES, OR FROM THE FAILURE OF THE WARRANTORS' SYSTEM TO REPORT A GIVEN EVENT OR CONDITION, WHETHER OR NOT CAUSED BY WARRANTORS' NEGLIGENCE.

YOU AGREE TO RELEASE, WAIVE, DISCHARGE AND COVENANT NOT TO SUE WARRANTORS, THEIR OWNERS, DIRECTORS, OFFICERS, EMPLOYEES, AGENTS, SUPPLIERS OR AFFILIATED COMPANIES, FOR ANY AND ALL LIABILITIES POTENTIALLY ARISING FROM ANY CLAIM, DEMAND OR ACTION BASED UPON ANY LOSSES, LIABILITIES, DAMAGES OR COSTS, INCLUDING BUT NOT LIMITED TO DAMAGES THAT ARE DIRECT OR INDIRECT, INCIDENTAL, SPECIAL OR CONSEQUENTIAL, AND INCLUDING ATTORNEYS FEES AND LEGAL COSTS, THAT MAY RESULT FROM THE INSTALLATION, OPERATION, USE OF, OR INABILITY TO USE WARRANTORS' PRODUCTS AND SERVICES, OR FROM THE FAILURE OF THE WARRANTORS' SYSTEM TO REPORT A GIVEN EVENT OR CONDITION, WHETHER OR NOT CAUSED BY WARRANTORS' NEGLIGENCE, EXCEPT AS NECESSARY TO ENFORCE THE EXPRESS TERMS OF THIS LIMITED WARRANTY.

EXCLUSIVE WARRANTY: THE LIMITED WARRANTY OR WARRANTIES DESCRIBED HEREIN CONSTITUTE THE SOLE WARRANTY OR WARRANTIES TO THE PURCHASER. ALL IMPLIED WARRANTIES ARE EXPRESSLY DISCLAIMED, INCLUDING: THE WARRANTY OF MERCHANTABILITY AND THE WARRANTY OF FITNESS FOR A PARTICULAR USE AND THE WARRANTY OF FITNESS FOR A

## Sentinel Installation and Setup Guide

PARTICULAR PURPOSE AND THE WARRANTY OF NON-INFRINGEMENT AND/OR ANY WARRANTY ARISING FROM A COURSE OF DEALING, USAGE, OR TRADE PRACTICE.

IT MUST BE CLEAR THAT THE WARRANTORS ARE NOT INSURING YOUR PREMISES OR BUSINESS OR GUARANTEEING THAT THERE WILL NOT BE DAMAGE TO YOUR PERSON OR PROPERTY OR BUSINESS IF YOU USE THIS PRODUCT. YOU SHOULD MAINTAIN INSURANCE COVERAGE SUFFICIENT TO PROVIDE COMPENSATION FOR ANY LOSS, DAMAGE, OR EXPENSE THAT MAY ARISE IN CONNECTION WITH THE USE OF PRODUCTS OR SERVICES, EVEN IF CAUSED BY WARRANTORS' NEGLIGENCE. THE WARRANTORS ASSUME NO LIABILITY FOR INSTALLATION OF THE PRODUCT AND/OR INTERRUPTIONS OF THE SERVICE DUE TO STRIKES, RIOTS, FLOODS, FIRE, AND/OR ANY CAUSE BEYOND SELLER'S CONTROL, FURTHER SUBJECT TO THE LIMITATIONS EXPRESSED IN ANY LICENSE AGREEMENT OR OTHER AGREEMENT PROVIDED BY WARRANTORS TO PURCHASER.

THE AGREEMENT BETWEEN THE WARRANTORS AND THE PURCHASER, INCLUDING BUT NOT LIMITED TO THE TERMS AND CONDITIONS HEREIN SHALL NOT BE GOVERNED BY THE CONVENTION FOR THE INTERNATIONAL SALE OF GOODS. WHERE APPLICABLE, THE UNIFORM COMMERCIAL CODE AS ADOPTED BY THE STATE OF DELAWARE SHALL APPLY.

**4. PROCEDURE FOR OBTAINING PERFORMANCE OF WARRANTY:** IN THE EVENT THAT THE PRODUCT DOES NOT CONFORM TO THIS WARRANTY, THE PRODUCT SHOULD BE SHIPPED OR DELIVERED FREIGHT PREPAID TO A WARRANTOR WITH EVIDENCE OF ORIGINAL PURCHASE.

**5. LEGAL REMEDIES AND DISCLAIMER:** SOME JURISDICTIONS MAY NOT ALLOW, OR MAY PLACE LIMITS UPON, THE EXCLUSION AND/OR LIMITATION OF IMPLIED WARRANTIES, INCIDENTAL DAMAGES AND/OR CONSEQUENTIAL DAMAGES FOR SOME TYPES OF GOODS OR PRODUCTS SOLD TO CONSUMERS AND/OR THE USE OF INDEMNIFICATION TERMS. THUS, THE EXCLUSIONS, INDEMNIFICATION TERMS AND LIMITATIONS SET OUT ABOVE MAY NOT APPLY, OR MAY BE LIMITED IN THEIR APPLICATION, TO YOU. IF THE IMPLIED WARRANTIES CAN NOT BE EXCLUDED, AND THE APPLICABLE LAW PERMITS LIMITING THE DURATION OF IMPLIED WARRANTIES, THEN THE IMPLIED WARRANTIES HEREIN ARE TO BE LIMITED TO THE SAME DURATION AS THE APPLICABLE WRITTEN WARRANTY OR WARRANTIES HEREIN. THE WARRANTY OR WARRANTIES HEREIN MAY GIVE YOU SPECIFIC LEGAL RIGHTS THAT WILL DEPEND UPON THE APPLICABLE LAW. YOU MAY ALSO HAVE OTHER LEGAL RIGHTS DEPENDING UPON THE LAW IN YOUR JURISDICTION.

**6. CHOICE OF FORUM AND CHOICE OF LAW:** IN THE EVENT THAT A DISPUTE ARISES OUT OF OR IN CONNECTION WITH THIS LIMITED WARRANTY, THEN ANY CLAIMS OR SUITS OF ANY KIND CONCERNING SUCH DISPUTES SHALL ONLY AND EXCLUSIVELY BE BROUGHT IN EITHER THE COURT OF COMMON PLEAS OF DELAWARE COUNTY, PENNSYLVANIA OR THE UNITED STATES DISTRICT COURT FOR THE EASTERN DISTRICT OF PENNSYLVANIA.

REGARDLESS OF THE PLACE OF CONTRACTING OR PERFORMANCE, THIS LIMITED WARRANTY AND ALL QUESTIONS RELATING TO ITS VALIDITY, INTERPRETATION, PERFORMANCE AND ENFORCEMENT SHALL BE GOVERNED BY AND CONSTRUED IN ACCORDANCE WITH THE LAWS OF THE STATE OF DELAWARE, WITHOUT REGARD TO THE PRINCIPLES OF CONFLICTS OF LAW.

Effective date 02/25/2015

PHONETICS, INC. d.b.a. SENSAPHONE

901 Tryens Road

Aston, PA 19014

Phone: 610.558.2700 Fax: 610.558.0222

[www.sensaphone.com](http://www.sensaphone.com)

# TABLE OF CONTENTS

|  |           |
|--|-----------|
| <b>CHAPTER 1: INSTALLATION</b> . . . . .                     | <b>9</b>  |
| <b>INTRODUCTION</b> . . . . .                                | <b>9</b>  |
| FEATURES . . . . .   | 9         |
| TECHNICAL SUPPORT . . . . .                                  | 9         |
| <b>ABOUT THIS MANUAL</b> . . . . .                           | <b>9</b>  |
| <b>INSTALLATION AND CONFIGURATION</b> . . . . .              | <b>10</b> |
| PHYSICAL DESCRIPTION . . . . .                               | 10        |
| LAYOUT . . . . .   | 10        |
| RJ-45 10/100BASE-T ETHERNET PORT . . . . .                   | 10        |
| SENSOR INPUTS . . . . .                                      | 10        |
| POWER ON LED (GREEN) . . . . .                               | 10        |
| ALARM LEDS (RED) . . . . .                                   | 10        |
| ONLINE LED (GREEN) . . . . .                                 | 10        |
| STANDBY LED (YELLOW) . . . . .                               | 10        |
| ACKNOWLEDGE/ STANDBY BUTTON . . . . .                        | 11        |
| <b>INSTALLATION</b> . . . . .                                | <b>11</b> |
| PARTS REQUIRED . . . . .                                     | 11        |
| OPERATING ENVIRONMENT . . . . .                              | 11        |
| POWER . . . . .  | 11        |
| NETWORK CONFIGURATION . . . . .                              | 11        |
| WALL MOUNT INSTALLATION . . . . .                            | 12        |
| <b>CONNECTING SENSORS</b> . . . . .                          | <b>12</b> |
| GENERAL WIRING CONSIDERATIONS . . . . .                      | 12        |
| NORMALLY OPEN / NORMALLY CLOSED DRY CONTACTS . . . . .       | 13        |
| 2.8K/10K TEMPERATURE SENSORS . . . . .                       | 14        |
| 4–20MA CURRENT LOOP TRANSDUCERS . . . . .                    | 14        |
| RELAY OUTPUT WIRING . . . . .                                | 15        |
| BATTERY BACKUP . . . . .                                     | 15        |
| MEMORY/CLOCK BATTERY . . . . .                               | 15        |
| RESETTING THE SENTINEL TO FACTORY DEFAULT SETTINGS . . . . . | 16        |
| <b>CHAPTER 2: SET UP</b> . . . . .                           | <b>17</b> |
| <b>DESCRIPTION OF WEB PAGES</b> . . . . .                    | <b>17</b> |
| DASHBOARD . . . . .  | 17        |
| STANDBY MODE . . . . .                                       | 18        |
| DEVICE DETAILS . . . . .                                     | 18        |
| CONFIGURE DEVICE . . . . .                                   | 19        |
| ZONE PARAMETER DEFINITIONS . . . . .                         | 20        |
| MANAGE USERS . . . . .                                       | 21        |
| MANAGE USER GROUPS . . . . .                                 | 23        |
| ALARM DELIVERY . . . . .                                     | 23        |
| LOGS . . . . .   | 25        |
| DEVICE MANAGEMENT . . . . .                                  | 25        |
| DEVICE GROUPS . . . . .                                      | 26        |

|  |           |
|--|-----------|
| <b>CHAPTER 3: CONFIGURING THE RELAY OUTPUT.</b>  | <b>27</b> |
| RELAY OUTPUT WIRING                              | 28        |
| <b>APPENDIX A: WEEKLY TESTING PROCEDURE</b>      | <b>29</b> |
| <b>APPENDIX B: ACCESSORIES.</b>                  | <b>30</b> |
| <b>APPENDIX C: SPECIFICATIONS.</b>               | <b>31</b> |
| ALERT ZONES                                      | 31        |
| RELAY OUTPUT                                     | 31        |
| DATA LOGGING                                     | 31        |
| COMMUNICATION TYPE:                              | 31        |
| POWER SUPPLY                                     | 31        |
| BATTERY BACKUP                                   | 32        |
| ENVIRONMENTAL                                    | 32        |
| PHYSICAL   | 32        |
| <b>APPENDIX D: THERMISTORS</b>                   | <b>33</b> |
| 2.8K THERMISTOR DATA                             | 33        |
| 10K THERMISTOR DATA                              | 33        |
| <b>APPENDIX E: RETURNING THE UNIT FOR REPAIR</b> | <b>34</b> |
| <b>APPENDIX F: TEST LOG</b>                      | <b>35</b> |



# CHAPTER 1: INSTALLATION

## INTRODUCTION

Congratulations on your purchase of the Sentinel Monitoring System. The system is designed to be an easy, cost-effective, cloud-based monitoring and data logging system to notify you when equipment or conditions go awry. The internet browser-based programming makes the device easy to use from any computer or tablet. Monitored conditions can include temperature, humidity levels, pressure, flow, leak detection, UPS systems, and more. The system allows multiple users to be notified immediately of any detected problems. Notification can occur via voice call, e-mail or SMS (text message), however voice calls and text messages require a premium subscription plan. The internal battery backup system insures the unit will continue to run if main power fails.

## FEATURES

The Sentinel includes the following key features:

- Twelve sensor inputs to monitor environmental conditions and/or alarm contacts from other equipment.
- 10/100BASE-T Ethernet port.
- Battery backup for uninterrupted performance.
- Compact design allows wall-mount or weatherproof installation.
- Notification via e-mail, text message (optional) and voice call (optional).
- Relay output capable of automatic or manual control.
- Cloud-based user interface for programming, data storage, and alarm delivery.
- Available in optional weatherproof NEMA 4X enclosure
- Available with cellular modem in weatherproof NEMA 4X enclosure

## TECHNICAL SUPPORT

If any questions arise upon installation or operation of the Sentinel, please contact the Sensaphone Technical Service Department at 610.558.2700 and have the following information available:

- Date of purchase \_\_\_\_\_
- Serial number \_\_\_\_\_

Technical support is available from 8:00 AM to 5:00 PM, M-F, eastern time.

## ABOUT THIS MANUAL

This manual comprises the instructions necessary to install and setup the Sentinel. You should thoroughly read this manual to establish a basic understanding of the system and keep it as a reference.

## INSTALLATION AND CONFIGURATION

### PHYSICAL DESCRIPTION

The Sentinel is housed in a 5.5" x 5.5" x 1.5" enclosure, which can be easily mounted on a wall or back panel.

### LAYOUT

The Sentinel has connections for twelve sensor inputs, an Ethernet port, and 12VDC power. See figure below:

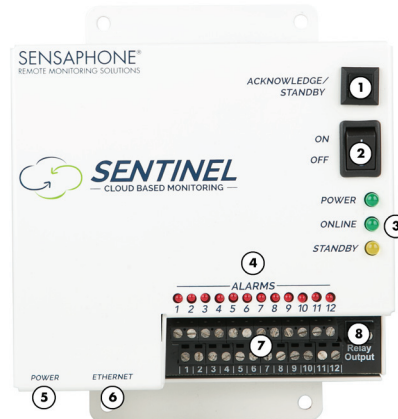

Figure 1: Front Panel Layout of the Sentinel

- |                                |                                |
|--------------------------------|--------------------------------|
| 1) Acknowledge/Standby Button  | 5) Power Jack                  |
| 2) On/Off Switch               | 6) Ethernet Jack               |
| 3) Power, Online, Standby LEDs | 7) Sensor Input Terminal Strip |
| 4) Alarm LEDs                  | 8) Relay Output Input          |

### RJ-45 10/100BASE-T ETHERNET PORT

This jack is for connecting to your network so that the device can communicate with the Sentinel servers. Two LEDs indicate when the Sentinel has a valid link (green) and transmitted/received data (yellow).

### SENSOR INPUTS

The sensor inputs labeled zones 1-12 are designed to interface with normally open/normally closed devices, 2.8K or 10K temperature sensors and 4-20mA transducers.

### POWER ON LED (GREEN)

This light indicates that the Sentinel unit is powered and operational.

### ALARM LEDS (RED)

The Alarm LEDs indicate if an alarm exists.

### ONLINE LED (GREEN)

This light indicates that the Sentinel unit is communicating with the Sentinel servers.

### STANDBY LED (YELLOW)

This light indicates that the Sentinel unit is in standby mode.

## ACKNOWLEDGE/ STANDBY BUTTON

When an unacknowledged alarm exists (as indicated by a blinking red alarm LED), briefly press the button and the alarm LED will stop blinking, indicating that the alarm is acknowledged. To enter Standby mode, press and hold the button for at least 5 seconds until the Standby LED lights up, then release. To exit from Standby mode, hold the button down for 5 seconds until the Standby LED turns off.

## INSTALLATION

This section provides information on:

- Operating environment
- Installation
- Connecting sensors
- Network Configuration

## PARTS REQUIRED

- Screwdriver and #8 screws
- Network Hub, Switch, or Router that supports 10 or 100 BASE-T with Internet access
- Computer w/Internet Connection

## OPERATING ENVIRONMENT

Before you install the Sentinel be sure that your operating environment meets the physical requirements of the equipment.

|                        |                                    |
|------------------------|------------------------------------|
| Operating Temperature: | 32° – 122° Fahrenheit (0° – 50° C) |
| Humidity:              | 5 – 90 %RH, non-condensing         |
| Power:                 | 115VAC 50/60 Hz outlet within 6'   |

## POWER

Connect the included DC power supply to the power jack on the Sentinel and then plug the power adapter into a 115V AC power outlet.

## NETWORK CONFIGURATION

The Sentinel requires an Internet connection to operate. Using the included network cable, connect the Sentinel to your 10/100 network hub, switch, or router. Note that your network must support DHCP for initial configuration. You can change it to a Static IP later if required (see chapter 2). The green ONLINE LED should light up within a few minutes indicating that the device has connected to the Sensaphone.net servers.

Technical Info: The Sentinel communicates over port 443 (the standard TCP port that is used for websites which use SSL encryption), so this must be open for outbound communication. The device also makes use of port 123 for clock synchronization (NTP), so this must be open for UDP outbound.

## WALL MOUNT INSTALLATION

The Sentinel can be wall mounted using dry wall anchors and (4) #8 screws. Follow the steps below:

- 1) Install four drywall anchors (if necessary). Attach the Sentinel using four #8 tapping screws. See Figure 2 for dimensions.
- 2) Attach sensors to the zone terminals.
- 3) Plug the power adaptor into a 115VAC 50/60Hz outlet.
- 4) Connect a CAT5 cable to the Ethernet port and connect to a 10/100 network hub, switch or router.

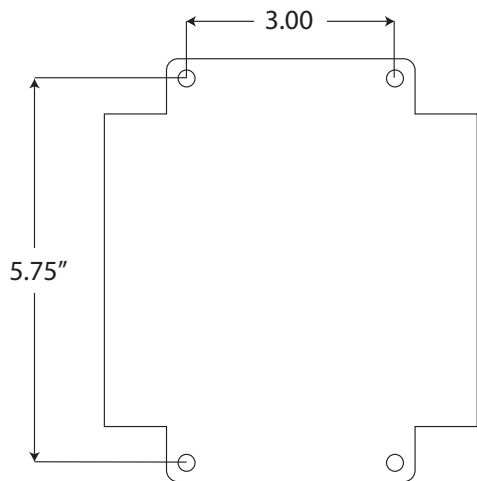

Figure 2: Sentinel mounting dimensions

## CONNECTING SENSORS

The Sentinel is compatible with a wide variety of sensors including normally open/normally closed contacts, 2.8K and 10K temperature sensors, and 4–20mA current sources. Compatible sensors and accessories are shown on the Sentinel website. Sensors may be connected while the device is powered on or off. A proper size screwdriver is provided for your convenience. Contact Sensaphone or your Sensaphone reseller for assistance in selecting sensors for your monitoring requirements. A list of sensors and accessories is shown in Appendix B. Follow the instructions below to properly wire and configure the inputs for each type of electrical signal.

**Warning:** The inputs are designed to work with low voltage signals. DO NOT connect voltages greater than 3.3V to the inputs. DO NOT connect 120VAC to the inputs.

## GENERAL WIRING CONSIDERATIONS

Most dry contact sensors can be connected to the Sentinel using inexpensive 2-conductor twisted-pair cable as small as #24 AWG. For temperature and 4–20mA sensors, use the wire chart below as a reference for selecting the appropriate wire gauge. Note that if the sensor is located far from the unit or if you are running cable in an electrically noisy environment, you should seriously consider using shielded cable. This will shield the signal from electrical interference, thereby preventing false readings and/or damage to the unit. For your convenience, Sensaphone has 22 gauge shielded cable available in 50' lengths (part number FGD-0010). To minimize electrical noise coupling between sensor wires and other wiring, follow the guidelines listed below:

- Route the power supply and network cables to the unit by a separate path than the wiring to the sensor inputs. Where paths must cross, their intersection should be perpendicular.
- Do not run sensor wiring and AC power in the same conduit.
- Segregate wiring by signal type. Bundle wiring with similar electrical characteristics together.
- If shielded cable is used, tie the shield to the input ground terminal.

| <u>Wiring Distance</u> | <u>Minimum Wire Gauge</u> |
|------------------------|---------------------------|
| 700'                   | #24 AWG                   |
| 1500'                  | #22 AWG                   |
| 2500'                  | #20 AWG                   |

The zone terminal strip has an upper and lower level for connecting up to 12 sensors. The lower level terminals are all “ground” and are electrically connected together. The upper terminal strip is the positive connection for each sensor. See illustration below.

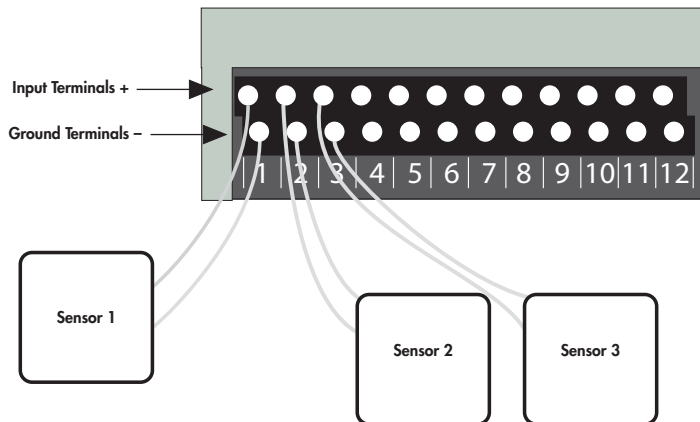

## NORMALLY OPEN / NORMALLY CLOSED DRY CONTACTS

Dry contact sources consist of alarm relays or switches that are isolated and have no external voltage applied. These devices can be connected directly to the zone terminals without regard for polarity. Choose a zone and connect the wires to the corresponding screw terminals for that zone. The following figure shows how to connect a dry contact sensor:

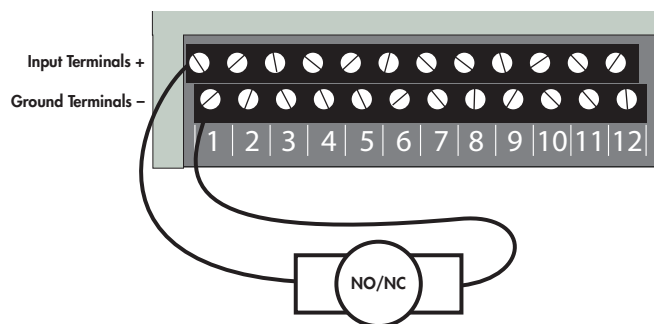

Dry Contact Sensor

Wiring a Dry Contact Sensor

## 2.8K/10K TEMPERATURE SENSORS

The Sentinel is compatible with 2.8K/10K temperature sensors that match the curve data listed in the tables in Appendix D. The monitoring temperature range of the 2.8K thermistor is -109 to 115°F (-85° to 57°C) and the 10K thermistor is -87° to 168°F (-66° to 76°C). Temperature sensors can be connected directly to the zone terminals without regard for polarity. Choose an alarm input and connect the wires to the corresponding screw terminals for that zone. 2.8K and 10K temperature sensors are available from Sensaphone. See Appendix B for part numbers. The figure below shows how to connect a temperature sensor:

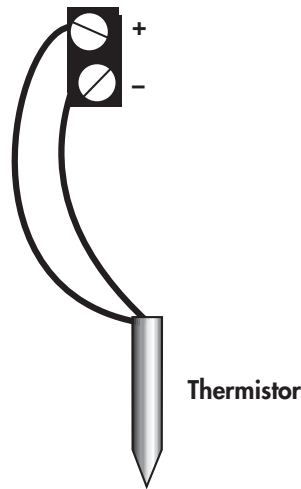

Wiring a Temperature Sensor

## 4-20mA CURRENT LOOP TRANSDUCERS

The inputs on the Sentinel are compatible with transducers that produce an analog output current of 4 to 20mA. Such transducers are available to measure tank and well levels, extreme temperatures, air pressure, water pressure, flow, voltage, current, rotational speed, etc. Contact our technical support department for assistance regarding your monitoring requirements (877-373-2700 or support@sensaphone.com). Follow the wiring diagrams below for connecting a 4-20mA device:

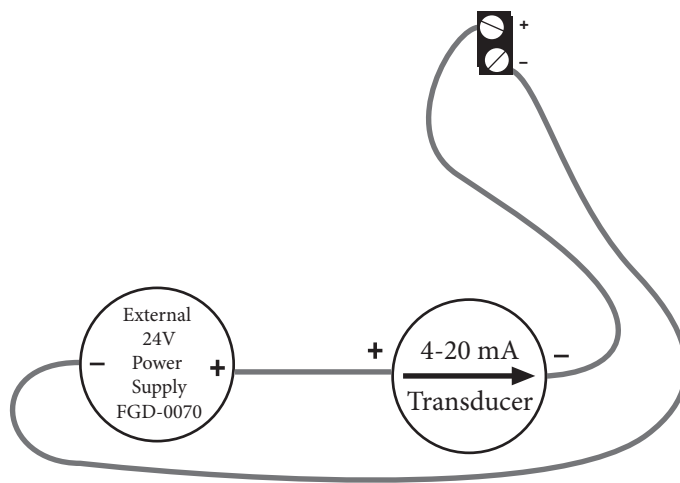

Wiring a 4-20mA device using an external 24 VDC supply.

## RELAY OUTPUT WIRING

The Sentinel includes a relay output (switch) that can be used to turn on a light, siren, or other device whenever an alarm occurs. The output is a normally-open (i.e. off) dry contact that can be used for low voltage switching. The relay is rated for up to 30VAC/VDC 1 Amp. A sample wiring diagram is shown below:

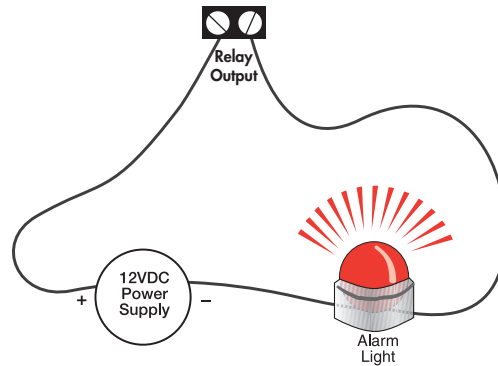

The relay can be controlled manually (via the website or App) or automatically based on specific inputs or alarms. See chapter 3 for details.

## BATTERY BACKUP

The Sentinel has an internal rechargeable battery backup pack (part #FGD-0032) which will provide up to 8 hours of backup time in the event of a power failure. The unit will charge the battery and monitor its charge level. The percent charge can be viewed on the website. The Sentinel contains circuitry to protect the battery from deep discharge damage and will disconnect the battery when all of its available energy has been expended. The battery backup module should last 4 to 5 years.



## MEMORY/CLOCK BATTERY

The Sentinel contains a CR2 lithium battery to backup certain values in SRAM memory as well as the real-time clock. This battery should last between 5-10 years depending on how much time the device is powered off. {Note: Units manufactured prior to May 2016 contain a CR2032 lithium coin cell which has an estimated life of 2 - 5 yrs}.

## **RESETTING THE SENTINEL TO FACTORY DEFAULT SETTINGS**

In the event that you can no longer connect to your Sentinel, you can reset the unit to factory defaults. On the bottom of the unit is a small hole. Beneath the hole is a push button. Insert a paper clip or similar item into the hole and push the button for 5 seconds while the device is powered on. The Sentinel will erase all of its programming and then reboot automatically. Alternatively you can also reset the device to defaults from the Sensaphone.net website. Go to the Manage Devices page, under the Admin menu. Select the device, choose Reset to Default Values from the drop down, and click Submit.



# CHAPTER 2: SET UP

When your Sentinel “Online” LED is lit you can continue with the following website section.

1. Open an internet browser and go to [www.sensaphone.net](http://www.sensaphone.net).
2. Fill in the form to create a new account.

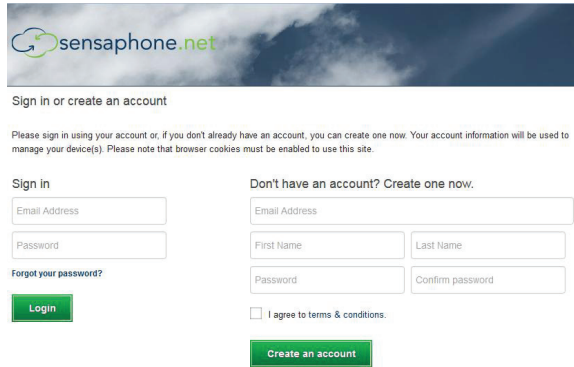

The screenshot shows the Sensaphone.net website with a navigation bar containing 'Dashboard', 'Users', and 'Admin'. Below the navigation bar is the 'Manage Devices' section. On the left, under 'Your Devices', it states 'There are no devices on this account. Fill out the form on the right to add a device.' On the right, under 'Add a Device', there is a form with the following fields: 'Serial Number' (with a placeholder '### ## ## ## ## ## ## ## ## ##'), 'Device Name' (with the value 'McHenry Center'), and an 'Add Device' button.

3. Once you are logged in, click *Admin*, then *Manage Devices*. In the “Add a Device” section, enter the Serial Number of your Sentinel and enter a device name. Click the *Add Device* button when finished.

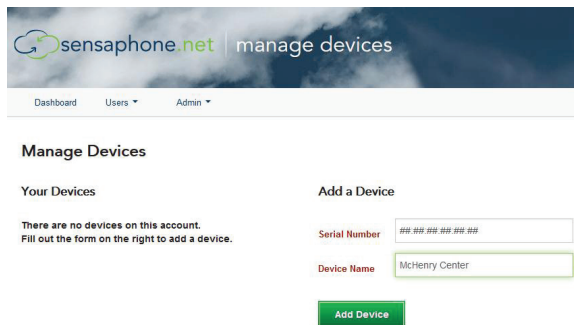

The screenshot shows the Sensaphone.net dashboard. At the top, there is a navigation bar with 'Dashboard', 'Users', and 'Admin'. Below the navigation bar is the 'Manage Devices' section. On the left, under 'Your Devices', it states 'There are no devices on this account. Fill out the form on the right to add a device.' On the right, under 'Add a Device', there is a form with the following fields: 'Serial Number' (with a placeholder '### ## ## ## ## ## ## ## ## ##'), 'Device Name' (with the value 'McHenry Center'), and an 'Add Device' button.

Your Sentinel is now online with the Sensaphone.net website. Read the section below to learn how to view status and program your device.

## DESCRIPTION OF WEB PAGES

### DASHBOARD

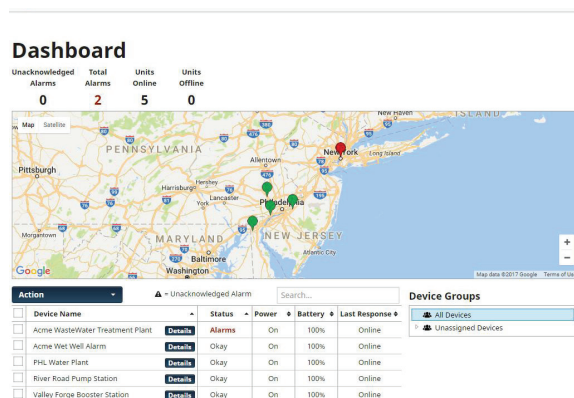

The screenshot shows the Sensaphone.net dashboard. At the top, there is a navigation bar with 'Dashboard', 'Users', and 'Admin'. Below the navigation bar is the 'Manage Devices' section. On the left, under 'Your Devices', it states 'There are no devices on this account. Fill out the form on the right to add a device.' On the right, under 'Add a Device', there is a form with the following fields: 'Serial Number' (with a placeholder '### ## ## ## ## ## ## ## ## ##'), 'Device Name' (with the value 'McHenry Center'), and an 'Add Device' button.

The dashboard will list all of the devices on your account. This page is automatically updated with the most current information available.

The numbers at the top will show how many Unacknowledged Alarms, Current Alarms, Units Online, and Units Offline that currently exist for all devices on your account.

The map will show the location of any device on your account that has an address or GPS location listed. You can hover over the icon to see the device name and status. If the icon for the device is green, your device status is OK. If it is red, your device has alarms. You can click on the icon to show the zones for the selected device.

## Sentinel Installation and Setup Guide

The device table will display all devices on your account. Click on the *Details* button to display and configure the zones for that device. You can also use the search box above the table to search through the table, or click on the table column headers to sort the data.

**Device Name** – The name of the device

**Status** – The current status of the device (Okay, Alarms, Offline, or Standby) If the device has any unacknowledged alarms, a symbol will be displayed in this column

**Power** – Displays if the device is On or Off (--- will display if the device is offline)

**Battery** – The current percentage of the device battery (--- will display if the device is offline)

**Last Response** – The time that the device last connected to the server

## STANDBY MODE

Standby mode puts the Sentinel in a temporary state such that no alarms will be detected, allowing onsite personnel to perform maintenance or other tasks that may have triggered an alarm otherwise. Standby mode can be entered using the Action drop down on the Dashboard page or via the pushbutton on the front of the unit. Standby mode will persist for the duration of time entered on the Device Configure screen and will automatically exit once the time expires. When using the pushbutton you must depress the button for 5 seconds. The Standby LED will light up to indicate that the device is in Standby mode. You can also exit Standby mode using the same methods.

**Standby** – Allows you to put the selected devices into Standby mode

**Enter** – Put the Sentinel in Standby mode for the length of time that is set on the Device Configure page

**Enter (Untimed)** – Put the Sentinel in Standby mode until you disable it

**Exit** – Take the device out of Standby mode

## DEVICE DETAILS

The device details page displays the sensor values for your Sentinel. This page is automatically updated with the most current information available. At the top of the page are buttons to access the *Configuration*, *Alarm Delivery* and *Logs*.

The screenshot shows the 'Sentinel Demo' device details page. At the top, there are buttons for 'Configure Device', 'Alarm Delivery', and 'Device Logs'. The device status is 'Okay'. Below this is a table of sensor zones with columns for Zone, Type, Value, and Status. The status bar at the bottom shows 'Okay', 'OK', '100%', and '1.7 minutes'.

| Zone                 | Type              | Value         | Status |
|----------------------|-------------------|---------------|--------|
| Power                | Power             | On            | OK     |
| Battery              | Battery           | 100%          | OK     |
| High Pump Level      | Normally Open     | OK            | OK     |
| Flow Rate            | 4-20mA            | 81.249 gpm    | OK     |
| Ambient Temperature  | 2 BK Thermistor F | 75.4F         | OK     |
| Generator Fuel Level | 4-20mA            | 281.233 Gal   | OK     |
| Security Door        | Normally Closed   | OK            | OK     |
| Leak Detector        | Normally Closed   | OK            | OK     |
| Diss Oxygen          | 4-20mA            | 37.656 mg/L   | OK     |
| pH                   | 4-20mA            | 9.376         | OK     |
| Sp Conductance       | 4-20mA            | 2624.970 umho | OK     |
| Salinity             | 4-20mA            | 856.222 ppm   | OK     |
| Turbidity            | 4-20mA            | 13.586 ntu    | OK     |
| Zone 12              | Normally Open     | OK            | OK     |
| Output               | Relay Output      | Off           | OK     |

At the top of the page, you will see the device name, description, address and alarm status.

You will also see all of the zones for your device in the table.

**Zone** – The name of the zone

**Value** – The current value of the zone

**Status** – The current status of the zone

**Min/Max** – Displays the highest and lowest values recorded

If the device has any unacknowledged alarms, a symbol will be displayed in the status column

The Action dropdown menu provides options that allow you to interact with your device, such as acknowledging alarms, resetting pulse count, runtime and min/max values, and putting the device into standby mode.

## CONFIGURE DEVICE

At the top of the dashboard, click *Configure Device* to go to the device and zone programming screens.

The box on the left will display all of your configureable zones, as well as Device (for general device settings), Power, Battery and Relay Output. As you select an option, the form on the right will change to display the appropriate data. Complete the address so that the Sentinel icon will be displayed at the appropriate location on the dashboard map.

This page also contains settings for the *Device Offline* alarm and for *Standby Mode*. The *Device Offline* alarm will notify you if your devices stops communicating with the sensaphone.net servers for the programmed time duration.

Once you have completed your programming, click on the *Save Settings* button at the bottom of the page.

Configure Device - Sentinel Demo Audit Log Links OFF

Device Details **Configure Device** Default Alarm Delivery Device Logs

Device: Sentinel Demo Offline Alarm Delivery

Power

Battery

1: High Sump Level

2: Flow Rate

3: Ambient Temperature

4: Generator Fuel Level

5: Security Door

6: Leak Detector

7: pH

8: Dissolved Oxygen

9: Sp Conductance

10: Salinity

11: Turbidity

12: Total Flow Output

Serial Number: 00-1F-2C-50-7F-40

Firmware: v.1.6.68

Subscription: Premium

Device Status: **Alarms**

**Device Information**

Name: Sentinel Demo

Description: Water Treatment System

Start typing an address for autocompletion... powered by Google

Address Line 1: 6001 W Pershing Rd

Address Line 2: Address Line 2

City: cicero

State/Subdivision: Illinois

Postal Code: 60804

Country: United States

Timezone: Central Time

GPS Coordinates: Latitude: longitude: longitude

**Device Settings**

Standby Time: 5 Minutes

Offline Timeout: 30 minutes

Note: Offline timeout will notify users when the device has stopped communicating with the cloud. [More Info](#)

**IP Settings**

DHCP

Configuration Restore/Copy

### Configuring a Static IP Address

If you would like to assign your device a Static IP address, go to the Configure Device page and scroll down to the IP Settings section. Uncheck the DHCP box and the network settings will appear so that you can enter a Static IP address, Gateway, etc... Click Save to have the new settings take effect.

**IP Settings**

DHCP

Mode: Ethernet

Address: 10.1.2.100

DNS: 10.1.2.80

Gateway: 10.1.2.1

Netmask: 255.255.255.0

## Zone Programming

Select the zone you would like to configure from the box from the left. A sample screen for a temperature sensor is shown below.

The screenshot shows the 'Configure Device' interface for an 'Ambient Temperature' sensor. On the left is a sidebar menu with options like Device, Power, Battery, High Sump Level, Flow Rate, Ambient Temperature (selected), Generator Fuel Level, Security Door, Leak Detector, Dis Oxygen, pH, Sp Conductance, Salinity, Turbidity, Zone 12, and Output. The main configuration area includes:
 

- Ambient Temperature** (Header)
- Zone Enable:** Radio buttons for Enable (selected) and Disable.
- Current Value:** 75.4F
- Zone Name:** Ambient Temperature
- Zone Type:** 2.5K Thermistor F
- Calibration:** 0
- Alarm Low:** 35
- Alarm High:** 105
- Alarm Delivery:** Radio buttons for Enable (selected) and Disable.
- Alarm Delivery Settings:**
  - Recognition Time:** 0 Hours, 5 Minutes, 0 Seconds
  - Alarm Hold Time:** 0 Minutes, 1 Seconds
  - Return To Normal:** Radio buttons for Enable and Disable (selected).
  - Alarm Reset:** Radio buttons for Enable (selected) and Disable.
- Datalog Settings:**
  - Mode:** Radio buttons for Continuous (selected), While in Alarm, and Disabled.
  - Alarm Interval:** 0 Hours, 15 Minutes
  - Normal Interval:** 0 Hours, 30 Minutes

 A green 'Save Settings' button is located at the bottom center.

## ZONE PARAMETER DEFINITIONS

**Enable/Disable:** This setting determines if the Zone is being used (Enabled) or not (Disabled). Selecting Disabled will remove the gauge from the Summary screen.

**Name:** Enter a name for the sensor you are monitoring which describes its purpose and/or location. The name will appear on the Device Details screen as well as on alarm messages.

**Type:** Choose the type of sensor you are connecting to the Zone input. For temperature sensors choose either degrees F or C.

**Units:** The Units field is used to describe the units of measure for the value being monitored. When Temperature is selected the Units field will automatically display F (Fahrenheit) or C (Celsius). When a 4-20mA type is selected you can enter the appropriate text for the monitored condition (e.g. %RH, PSI, GPM, RPM,...). When you select Normally Open (NO) or Normally Closed (NC) you can choose from several preset descriptions for the Open and Closed state of the input. The first word always describes the Open state of the contact and the second the Closed state. If you choose Custom you can enter your own text for the Open and Closed states. To do this simply type the words into the lower Units field and separate them with a slash (/). For example, "Slow/Fast", "Safe/Danger", "Dry/Wet".

**Calibration:** This field can be used to offset the Zone value either positive or negative if there is some error in the reading.

**Alarm Low:** This is used to determine the low level at which a temperature or 4–20mA Zone has reached the alarm threshold. The value must fall below the Alarm Limit to trip an alarm.

**Alarm High:** This is used to determine the high level at which a temperature or 4–20mA Zone has reached the alarm threshold. The value must exceed the Alarm Limit to trip an alarm.

**Table Low:** The Table Low value is used to define the lower range (4mA) of your 4-20mA sensor.

**Table High:** The Table High value is used to define the upper range (20mA) of your 4-20mA sensor.

**Alarm Delivery Enable/Disable:** When Enabled, alarm messages will be delivered, if set to Disabled alarm messages will not be delivered.

**Recognition Time:** This is the length of time that an alarm condition must be present before a valid alarm exists and message delivery is started.

**Alarm Hold Time:** When an alarm occurs, the *Alarm Hold Time* will latch the alarm condition for the programmed time period, thus preventing redundant alarms from sending additional notification messages. This is useful for alarms that are likely to trip several times within a short time period, such as motion detectors.

**Return to Normal Enable/Disable:** This feature instructs the Sentinel to send a message when a zone input has changed from an alarm condition back to a normal condition. Anyone who received the original alarm message will also be sent the Return-to-Normal message.

**Alarm Reset Enable/Disable:** This setting enables or disables the Alarm Reset Feature. The Alarm Reset feature is used to re-send alarm messages in the event that a fault condition is not corrected in a timely fashion. If an alarm continues to exist for the duration of the programmed Reset Time (see below) the alarm will reset (reactivate) and the alarm message delivery process will begin all over again. This is an optional feature.

**Alarm Reset Time:** This is the time allowed for an alarm's fault condition to be corrected before the Sentinel resets (reactivates) the alarm and begins the message delivery process all over again. It is recommended that this be set to no lower than 30 minutes to prevent numerous messages from being sent.

**Datalogging Mode:** The Sentinel has two modes of data logging for each zone: Continuous or While In Alarm. In Continuous mode the unit will log the value of the input on a fixed time interval all the time. The Normal Interval sets the logging rate while the value is within the normal range. The Alarm Interval sets the logging rate while the value is an alarm condition. By choosing the While In Alarm mode you can choose to have the unit only log values when it exceeds the alarm limits.

**Alarm Datalog Interval:** This is the interval that data will be logged while the input is beyond the programmed alarm limits. (Note: this is regardless of the programmed Alarm Recognition Time).

**Normal Datalog Interval:** This is the interval that data will be logged while the input is within the programmed alarm limits. To maximize the available memory for datalogging, set the Datalog Interval for each zone to multiples of each other. For example, Zone 1 can be set to 10 minutes, Zone 2 to 30 minutes, Zone 3 to 60 minutes, etc...

## MANAGE USERS

The sensaphone.net website allows you to set up users that will be linked to your account. Each user can be configured to have their own login for website access and/or be contacted for alarms. In addition, you can choose to give alarm acknowledgement capability to each user.

There are several levels of permissions that can be assigned to each user. You can also enter contact information for alarm delivery purposes. From the main menu, select *Users*, then *Manage Users*. To add a new user, click on the *Add User* button. The example below shows a user setup as an administrator with four contact destinations.

**User Details**  
[View All Users](#) \* = Required Input Field

User Enable:  Enable  Disable

Site Access: Administrator ▼

Alarm Delivery: Allow Acknowledgement ▼

---

**User Information**  
User information is kept private and is for your use only. We will never sell or disclose this information for any purpose.

User Name \*

Start typing an address for auto completion...  
powered by Google

Address Line 1

Address Line 2

City

State/Subdivision

Postal Code

Country

---

**Contact Details** [Add Contact](#) [User Schedule](#)

| Description      | Type    | Destination *          | Enable |   |
|------------------|---------|------------------------|--------|---|
| Joe's Office     | Phone ▼ | (888)555-1234          | Yes ▼  | <a href="#">Schedule</a> <a href="#">Delete</a> |
| Joe's Cell       | Text ▼  | 333-777-2222           | Yes ▼  | <a href="#">Schedule</a> <a href="#">Delete</a> |
| Joe's Home       | Phone ▼ | (111)888-4444          | Yes ▼  | <a href="#">Schedule</a> <a href="#">Delete</a> |
| Joe's Work Email | Email ▼ | jmchenry@mycompany.com | Yes ▼  | <a href="#">Schedule</a> <a href="#">Delete</a> |

---

**Login Details**

Email \*

Password \* [Set Password](#)

The following defines the various permission levels:

**Administrator** – Full site access, all devices on your account

**Supervisor** – Gives the user access to the Dashboard, device-specific pages (for example, Device Details), Manage Users, and Manage User Groups, but for only the devices you choose for them (chosen under the Device Groups section of the form). Supervisors will have the ability to create new users, but they can only give the users Supervisor access or lower.

**User** – Gives the user access to the Dashboard, but only shows the devices you choose for them (chosen under the Device Groups section of the form)

**None** – No access to the website

**Alarm Delivery** – Choose whether you would like the user to be able to receive alarm notifications or not.

**Disabled** – No alarm delivery

**Inform Only** – User is notified about the alarm, but cannot acknowledge it

**Allow Acknowledgement** – User is notified about the alarm and is able to acknowledge it

## User Information

Next, enter details about this user. The user’s name is the only required information.

## Contact Details

The *Contact Details* section is where you enter the telephone numbers, text numbers, and email addresses to send alarm messages. {Note that phone calls and text messages require a Premium Ethernet or Cellular subscription. Email alarm delivery is free}. A ‘1’ in the beginning of the telephone number is not required. To add additional contacts click “Add Contact”. Be sure to add all of your possible contact methods in this section. You can choose which ones get used on the *Default Alarm Delivery Schedule* or *Zone Alarm Delivery Schedule*.

You can also create a time schedule to limit when you’ll receive alarm messages. There is an overall *User Schedule* as well as individual Schedules for each contact. The default setting for all schedules is enabled, 24/7. In the sample screen below, the highlighted section shows the times when this user will be contacted for alarms:

**User Schedule**

[← Back to User](#)

User: Joe McHenry

Account Timezone: Eastern Time

Please configure the schedule during which the user’s contacts are available to receive alarms.

**Available:**

24/7

Custom Time Ranges

Tips: Click and drag down to create a time range. Click an existing time range to edit it. [Clear Schedule](#)

**Time Range Options**

Repeat this time range on these days: Edit the start and end time:

Sunday Start: 5:00am

Monday End: 3:00pm

Tuesday

Wednesday

Thursday

Friday

Saturday

[Okay](#) [Delete](#)

|      | Sunday | Monday               | Tuesday              | Wednesday            | Thursday             | Friday               | Saturday |
|------|--------|----------------------|----------------------|----------------------|----------------------|----------------------|----------|
| 12am |        |                      |                      |                      |                      |                      |          |
| 1am  |        |                      |                      |                      |                      |                      |          |
| 2am  |        |                      |                      |                      |                      |                      |          |
| 3am  |        |                      |                      |                      |                      |                      |          |
| 4am  |        |                      |                      |                      |                      |                      |          |
| 5am  |        | 5:00-3:00 Time Range | 5:00-3:00 Time Range | 5:00-3:00 Time Range | 5:00-3:00 Time Range | 5:00-3:00 Time Range |          |
| 6am  |        |                      |                      |                      |                      |                      |          |
| 7am  |        |                      |                      |                      |                      |                      |          |

\*Note that if you configure both a User Schedule and individual Contact Schedules, there must be overlap in order for alarm messages to be delivered.

## Login Details

Users will login with an email address and password. Enter this information in the *Login Details* section. In the event that a user forgets his/her password they can use the reset password feature on the main login page.

## Device Access

For accounts with multiple users and/or devices, you can choose to limit a user's access to selected devices. In the *Device Access* section, choose which units this User can access. See sample screen below:

**Device Access**

Administrators have access to all devices and groups.

|                                     |   |
|-------------------------------------|---|
| <input checked="" type="checkbox"/> |  Acme Wet Well Alarm             |
| <input checked="" type="checkbox"/> |  PHL Water Plant                 |
| <input checked="" type="checkbox"/> |  River Road Pump Station         |
| <input type="checkbox"/>            |  Valley Forge Booster Station    |
| <input type="checkbox"/>            |  Acme WasteWater Treatment Plant |

Click on 'Save Changes' once you are finished.

## MANAGE USER GROUPS

Allows you to set up groups of users that can be used on other site pages.

Select the group you wish to edit from the dropdown menu, or select *Create New Group* to make a new group.

Make sure to give each group a unique, descriptive name so they can be easily referenced.

Click on the plus icon to add users to the group. A pop up modal window will show that will list all the alarm users you have added to your account from the Manage Users page (see that page description for more information).

You can select an entire user (all destinations listed under that user at the time of the alarm will be notified) or individual destinations of the user.

Click on the red X icon to remove that user from the group.

Once you are finished adding and removing users, click on the *Save Group* button at the bottom of the page.

## ALARM DELIVERY

The Alarm Delivery section is where you configure the people that will be contacted when an alarm occurs. You can setup a *Default Alarm Delivery Schedule* (i.e. contact list) for each device or you can create a separate *Zone Alarm Delivery Schedule* for each individual zone. A combination of both can also be used (e.g. some zones use the default schedule and others use a custom schedule). The first step is to configure your Users and Contacts as described in the *Manage Users* section. If you haven't completed that step please do it first.

### Default Alarm Delivery Schedule

To get started select a device from the Dashboard and click *Details*. Next click the *Default Alarm Delivery* button. Click the *Add Destination* button to select people from your User list. You can select all of the User contacts or just a few if desired. See sample screen below:

Default Alarm Delivery - Sentinel Demo

[Device Details](#) | [Configure Device](#) | **Default Alarm Delivery** | [Device Logs](#)

3 Delivery Destinations

[Add Tier](#) | [Collapse](#) | [Delete Schedule](#)

Configure who gets contacted when an alarm condition is detected.

**Tier 1**  Final delivery (immediately after alarm detected)  Sequential Delivery [Add Destination](#)

| Order | Delivery Destination   | Delete                 |
|-------|--|------------------------|
| --    | User Name: Frank Johnson<br>Contacts: <ul style="list-style-type: none"> <li>Frank Johnson Text: 888-777-5555 (Text)</li> <li>Frank Johnson Cell: 888-777-5555 (Phone)</li> <li>Frank Johnson Work Email: Frank@mycompany.com (Email)</li> </ul> | <a href="#">Delete</a> |

**Tier 2**  Define Tier  Time Delay 15 minutes  Sequential Delivery [Add Destination](#)

| Order | Delivery Destination  | Delete                 |
|-------|---|------------------------|
| --    | User Name: Joe McHenry<br>Contacts: <ul style="list-style-type: none"> <li>Joe's Office: 888(555-1234) (Phone)</li> <li>Joe's Cell: 233-777-2222 (Text)</li> <li>Joe's Home: 111-888-4444 (Phone)</li> <li>Joe's Work Email: joe@mycompany.com (Email)</li> </ul> | <a href="#">Delete</a> |

**Tier 3**  Define Tier  Time Delay 30 minutes  Sequential Delivery [Add Destination](#)

| Order | Delivery Destination   | Delete                 |
|-------|--|------------------------|
| --    | User Name: Joseph Smith<br>Contacts: <ul style="list-style-type: none"> <li>Cell Phone: 555-222-7788 (Text)</li> <li>Work Email: jsmith@mycompany.com (Email)</li> </ul> | <a href="#">Delete</a> |

Continue clicking the *Add Destination* button to add additional Users to the list. If you would like to insert a delay between the first User (or group of Users) and the next User, click the *Add Tier* button and enter the delay time. Users in this Tier will not be contacted until the delay time expires. Click *Save Changes* when your schedule is complete.

\*Note that the Tier Delay timer starts at the time the alarm occurs. If the alarm is acknowledged before the delay time expires then Users in the 2nd Tier (and beyond) will not receive the alarm message. See sample programming screen below:

### Zone Alarm Delivery Schedule

A Zone Alarm Delivery Schedule is an alarm contact list that only applies to one specific zone. You can create a separate Zone Alarm Delivery Schedule for each individual zone if required. To configure a *Zone Alarm Delivery Schedule* select a Zone from the *Device Details* page. Then click the *Zone Alarm Delivery* tab on the right. Select *Custom* to configure a contact list for the selected zone. Follow the steps as described above to complete the schedule.

### Quick-Add Destinations

Quick-Add Destinations are those that can be easily entered to the notification list without creating a User Account. Note, however, that destinations added here will be inform-only (e.g. **cannot acknowledge alarms**). This entry method is useful for sending messages to people who do not require a user account in the system but may want to be informed when a particular alarm occurs.

### Alarm Acknowledgment

Alarms can be acknowledged from the dashboard page by selecting a device using the checkboxes next to each device, and then clicking the “Action” drop-down at the top of the screen. You can acknowledge both Device Offline alarms or Zone alarms. Devices with ‘Unacknowledged’ alarms are identified with an exclamation point within a triangle. Once the alarm is acknowledged this symbol will disappear. You can acknowledge multiple alarms on multiple devices at the same time. Alarms can also be acknowledged during telephone calls by entering 555 when prompted, or by replying to alarm messages sent via email, or by replying to a text message with the letters “Ack”.



## LOGS

The Sentinel includes an Alarm Log and Data Log. The Alarm Log lists all alarm activity for the selected device. You can narrow down the messages by individual zones or you can select multiple zones. The Data Log contains the recorded values for each zone based on the parameters you set up on the Zone Configuration screens. You can display the values on the screen as well as graph them. There is also an option to Save the data to a file. To get to the Device Logs section, click the *Details* button from the Dashboard for the device you would like to view, then click the *Device Logs* button.

**Alarm Log** – Shows the history of all alarm notifications that were sent for the device

**Data Log** – Show the history of all logged zone values and statuses for the device

**Export Data** - Allows you to save selected Alarm Log or Data Log records in either CSV or pdf format. Note that CSV formatted files can be opened in Microsoft Excel.

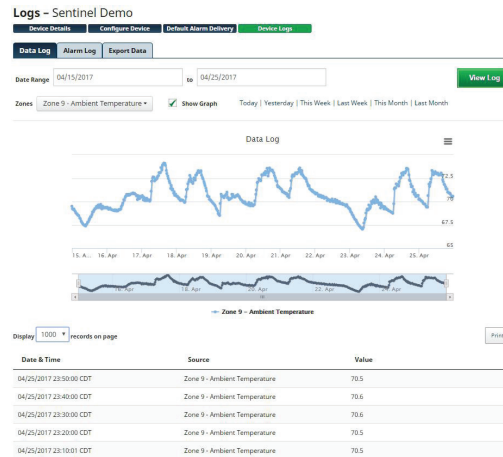

## DEVICE MANAGEMENT

You can add, modify, and remove Sentinel devices from your account on the Manage Devices screen. From the main menu select Admin, then Manage Devices. Listed below are the device-related actions that can be done.

**Adding Devices** - To add a new device to your account, enter the device serial number (located on the bottom of the unit in the format 00:07:F9:00:00:00) and give the device a name, then click *Add Device*.

**Reboot Device** - To reboot your device, select it from the list to the left and then choose Reboot Device from the drop down box at the bottom of the page, then click Submit. Your Sentinel will reboot and then reconnect within a few minutes. Your Sentinelgramming will remain intact.

**Remove From Account** - To remove a device from your account, select it from the list to the left and then choose Remove from Account from the drop-down box at the bottom of the page. Then click *Submit*.

**Reset to Default Values** - To reset a device to default settings, select it from the list to the left and then choose *Reset to Default Values* from the drop-down box at the bottom of the page. Then click *Submit*. Allow several minutes for your device to complete the reset process.

### Manage Devices

#### Your Devices

- Acme Wet Well Alarm - 00-07-F9-00-70-B1
- PHL Water Plant - 00-07-F9-00-71-88
- River Road Pump Station - 00-07-F9-00-71-80
- Valley Forge Booster Station - 00-07-F9-00-82-5D
- WasteWater Treatment Plant - 00-07-F9-00-82-F9

With Selected: Reset to Default Values

**Submit**

#### Add a Device

Serial Number

Device Name

**Add Device**

## DEVICE GROUPS

In cases where you have many devices and many users it may be desirable to create Device Groups. These can make it easier to assign device permissions to specified Users. From the main menu select Admin, then Device Groups. In the main window, you will see a list of all your devices and any groups you may have already created. Devices are shown with a green device icon and groups are shown with a black icon. You can have multiple groups, and you can even have groups within a group. If a device icon is lined up on the left-most side of the window, they are not in a group.

To add a new group, click on the Add Group button at the top of the page. A 'New Group' icon will appear in the list. You can rename the group by right clicking on it and selecting Rename. To move a device into a group, click on the device and drag it into the group. Continue adding devices until you're finished, then click Save Groups.

The blue number shown on the group icon shows how many devices are within that group. To remove a group, right click on the group and select Delete. Any devices in that group will be moved up one level. For example, if a group that had two devices was deleted, the two devices would be shifted to the left and would no longer be in any group. You can also click and drag a device or group to reorder them. To search through your devices click on Filters. You can choose to hide any device or group that does not match your search, and you can choose to only search through your devices and not your groups. Once you are finished editing your groups, click on the Save Groups button at the bottom of the page.

# CHAPTER 3: CONFIGURING THE RELAY OUTPUT

The Sentinel includes a relay output that can be used to control a light, siren, or other low voltage device. The output can be configured to switch either manually or automatically when a zone changes state or exceeds the alarm limits. To program the output click *Output* from the *Device Details* or *Configure Device* screen. The following configuration page will appear:

Enter a Name so that you'll know what the Output will be controlling. The Output can operate in Manual mode or Automatic mode. In manual mode you can turn the relay ON or OFF through the web page or the mobile App. To manually switch the relay output, click in the State field and select either ON or OFF, then click *Save Changes*. The change request will be sent to the Sentinel and the *Current Value* will update after the output change has successfully completed.

In Automatic mode the relay can be programmed to turn-on automatically when certain conditions are met. Listed below is a description of the parameters that apply to the automatic modes.

**Input Selection** - Next to the Automatic mode selection box is another drop-down that allows you to select which zones will control the output. There are four options (Zone List, Type List, All Inputs, and Limit: Zones).

**Zone List:** This option allows you to individually select which zones will cause the output to switch. Check the boxes next to the desired zones.

**Type List:** This option allows you select zones based on the zone Type. For example, you could have all of the zones configured for Temperature control the output.

**All Inputs:** This option selects all of the inputs (zones).

**Limit: Zones:** This option allows you to independently control the output based on the value of one or two zones using greater-than, less-than, or equal-to comparison statements. A separate Output-On and Output-Off instruction can be configured with its own comparison value. See sample below:

**Action** - This setting determines what the Output will do when the selected zone (or zones) exceeds the alarm limits. You can have the relay Activate (turn-on), Deactivate (turn-off), or Cycle (ON under normal conditions, momentarily OFF for 10 seconds when an alarm condition occurs, then back ON).

**Trigger** - The trigger determines what will cause the output to change state. There are 3 options to choose from which are described below:

**Unacknowledged Alarms:** Choosing this option will make the Output change to the setting defined by the Action for as long as an Unacknowledged Alarm persists on the selected zones. Once the alarm is acknowledged the Output will revert back to its normal position.

**Alarm Condition:** Choosing this option will make the Output change to the setting defined by the Action for as long as the selected input(s) remain in Alarm, regardless of acknowledgement. Once the selected zones return to their normal state the Output will revert back to its normal position.

**Zone State:** Choosing this option will make the output change to the setting defined by the Action as soon as the selected zones exceed the alarm limits. In other words, the alarm recognition time is not enforced, and the Output will change instantly. Once the selected zones return to their normal state the Output will revert back to its normal position.

## Relay Output Wiring

The relay output can be used to turn on a light, siren, or other low voltage device. The relay is rated for up to 30VAC/VDC 1 Amp. A sample wiring diagram is shown below:

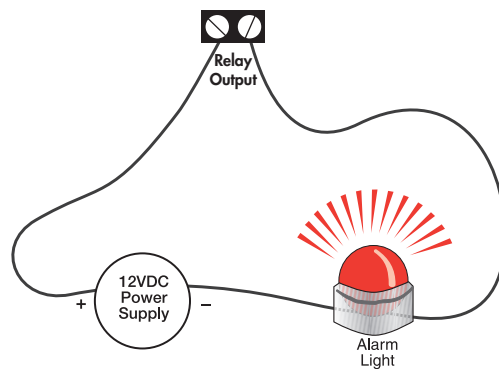

# APPENDIX A: WEEKLY TESTING PROCEDURE

We recommend that you test your Sensaphone weekly to be sure it is functioning properly. This will ensure that when a problem arises the Sensaphone will be ready to alert the appropriate personnel.

There are several tests that can be performed:

- 1.) Create an alarm on each zone by tripping all connected sensors.

**Temperature sensors:** Heat or cool the sensor.

**Motion sensors:** Have someone walk in front of the sensor.

**Door/window sensors:** open the door/window.

**Water sensors:** Apply a small amount of water beneath the sensor or use a wet towel and touch it to the sensor probes.

**Humidity sensors:** Raise the humidity around the sensor by holding a cup of very hot water beneath the sensor.

- 2.) Allow the unit to contact all programmed users. This will make sure that the Sensaphone is programmed properly. It will also prepare personnel to respond appropriately when they receive a message from the Sensaphone.

- 3.) Test the battery (if installed) by unplugging the AC adapter and making sure that the Sensaphone continues to function. Keep the AC adapter unplugged so that a Power Failure alarm occurs. Plug in the AC adapter after the unit has finished.

- 4.) Keep a log of your tests, noting the date and whether the Sentinel passed in each category tested. An example of such a log is shown below. (See “Test Log” at the end of this manual.)

| Date     | Inputs                              |                          | Alarm                               |                          | Battery                             |                          |         |
|----------|-------------------------------------|--------------------------|-------------------------------------|--------------------------|-------------------------------------|--------------------------|---------|
|          | Pass                                | Fail                     | Pass                                | Fail                     | Pass                                | Fail                     |         |
| 07/19/09 | <input checked="" type="checkbox"/> | <input type="checkbox"/> | <input checked="" type="checkbox"/> | <input type="checkbox"/> | <input checked="" type="checkbox"/> | <input type="checkbox"/> | Bob H   |
| 08/20/09 | <input checked="" type="checkbox"/> | <input type="checkbox"/> | <input checked="" type="checkbox"/> | <input type="checkbox"/> | <input checked="" type="checkbox"/> | <input type="checkbox"/> | Alex G. |
| 09/19/09 | <input checked="" type="checkbox"/> | <input type="checkbox"/> | <input checked="" type="checkbox"/> | <input type="checkbox"/> | <input checked="" type="checkbox"/> | <input type="checkbox"/> | Bob H.  |
|          | <input type="checkbox"/>            | <input type="checkbox"/> | <input type="checkbox"/>            | <input type="checkbox"/> | <input type="checkbox"/>            | <input type="checkbox"/> |         |
|          | <input type="checkbox"/>            | <input type="checkbox"/> | <input type="checkbox"/>            | <input type="checkbox"/> | <input type="checkbox"/>            | <input type="checkbox"/> |         |
|          |                                     |                          |                                     |                          |                                     |                          |         |
|          |                                     |                          |                                     |                          |                                     |                          |         |

If you require assistance, call Sensaphone Technical Support at 610-558-2700.

## APPENDIX B: ACCESSORIES

The sensors listed below are available from Sensaphone, and represent the most commonly used zone devices. Other dry contact sensors, designed for more specialized applications, may also be used. Commercial or industrial electrical supply houses can provide devices to monitor virtually any condition. For further information, contact Sensaphone Customer Service at 610-558-2700.

| Part #   | Description                             | Part #   | Sensor/Switch                       |
|----------|---|----------|-------------------------------------|
| BAT-0032 | Sentinel Battery                        | FGD-0100 | 2.8k Remote Temperature Sensor      |
| FGD-0006 | Magnetic Reed Switch                    | FGD-0101 | 2.8k Weatherproof Temperature Probe |
| FGD-0007 | Passive Infra-Red Detector              | FGD-0102 | 10k Weatherproof Temperature Probe  |
| FGD-0010 | 50' two-conductor #22AWG shielded Cable | FGD-0103 | 10k Indoor Decorator                |
| FGD-0013 | Spot Water Detector                     | FGD-0104 | 10k Outdoor Air Weatherproof        |
| FGD-0022 | Temp° Alert                             | FGD-0205 | Multi-Point Wireless I/O System     |
| FGD-0027 | Humidistat                              | FGD-0301 | Pressure Sensor                     |
| FGD-0049 | Smoke Detector with Built-in Relay      | FGD-0303 | Vibration Sensor                    |
| FGD-0052 | Humidity 4-20mA Transmitter             |          |                                     |
| FGD-0053 | 24VDC Power Supply                      |          |                                     |
| FGD-0054 | Power-Out Alert                         |          |                                     |
| FGD-0056 | Zone Water Detector w/Water Rope        |          |                                     |
| FGD-0063 | Additional 10' Water Rope for FGD-0056  |          |                                     |
| FGD-0065 | Carbon Monoxide Sensor                  |          |                                     |
| FGD-0066 | Air Quality Sensor                      |          |                                     |
| FGD-0067 | Surge Suppressor                        |          |                                     |
| FGD-0070 | Power supply with battery backup        |          |                                     |

# APPENDIX C: SPECIFICATIONS

## ALERT ZONES

Number of Zones: 12

Zone Connector: terminal block

Zone Types: N.O./N.C. contact, 2.8K Thermistor ( -109° to 115°F, -85° to 57°C ) And 10K Thermistor ( -87° to 168°F; -66° to 76°C), and 4-20mA ( -80,000.0 to 80,000.0

Zone Characteristics: 28.7KΩ to 3.3V (temperature/contact) or 250 Ohms to ground (4-20mA)

A/D Converter Resolution: 12 bits ±2 LSB

Zone Protection: 5.5VDC Metal Oxide Varistor with fast acting diode clamps.

Pulse Counting: 1ms minimum duration, 1 pulse-per-second maximum rate

## RELAY OUTPUT

Rated for 1A 30VAC/ 1A 30VDC Maximum

## DATA LOGGING

1 minute to 24 hour sampling rate

User programmable channel selection

Zones 1 – 12

Battery

Input Power

## LED INDICATORS

Power: On steady when the unit is powered on.

Alarm: Off when no alarm exists.

Ethernet Link and Activity LEDs

Online

Standby

## COMMUNICATION TYPE:

10/100 BASE-T Ethernet with SSL encryption

## POWER SUPPLY

Power Supply: 120VAC/12VDC 50/60Hz 6W wall plug-in transformer w/6' cord.

Power Consumption: 2 Watts

Power Protection: Metal Oxide Varistor

## **BATTERY BACKUP**

Rechargeable Battery: Internal 8 Hr NiMH Battery Pack (Part # BAT-0032).

Memory/Clock Battery: Internal 5-10 yr CR2 lithium (Part # BAT-0033).

## **ENVIRONMENTAL**

Operating Temperature: 32–122° F (0–50° C)

Operating Humidity: 0–90% RH non-condensing

Storage Temperature: 32°–140° F (0–60° C)

## **PHYSICAL**

SCD-1200

Enclosure: Powder-coated aluminum enclosure with tabs for wall or panel mounting

Physical Dimensions: 5.5" x 5.5" x 1.5" (140 mm x 140 mm x 38 mm)

Weight: 1 lb. (0.45 kg)

---

SCD-1200-CD, -SD (Weatherproof)

Enclosure: High impact polycarbonate, UL Type 4X/6P (IP66/68)

Physical Dimensions: 9.5" x 11.1" x 3.5" (241 mm x 282 mm x 89 mm)

Weight: 6 lb. (2.72 kg)

---

SCD-1200-4Gxxxx (Weatherproof w/Cellular Modem)

Enclosure: High impact polycarbonate, UL Type 4X (IP66)

Physical Dimensions: 12.0" x 13.7" x 7.4" (305 mm x 348 mm x 188 mm)

Weight: 14 lb. (6.35 kg)



# APPENDIX D: THERMISTORS

## 2.8K THERMISTOR DATA

| Degrees Celsius | Resistance (Ohms) |
|-----------------|-------------------|
| -50             | 187,625           |
| -40             | 94,206            |
| -30             | 49,549            |
| -20             | 27,180            |
| -10             | 15,491            |
| 0               | 9,142             |
| 10              | 5,572             |
| 20              | 3,498             |
| 30              | 2,256             |
| 40              | 1,491             |
| 50              | 1,009             |
| 60              | 697               |
| 70              | 490               |
| 80              | 351               |

## 10K THERMISTOR DATA

| Degrees Celsius | Resistance (Ohms) |
|-----------------|-------------------|
| -50             | 441.3K            |
| -40             | 239.8K            |
| -30             | 135.2K            |
| -20             | 78.91K            |
| -10             | 47.54K            |
| 0               | 29.49K            |
| 10              | 18.79K            |
| 20              | 12.25K            |
| 30              | 8,194K            |
| 40              | 5,592             |
| 50              | 3,893             |
| 60              | 2,760             |
| 70              | 1,990             |
| 80              | 1,458             |
| 90              | 1,084             |
| 100             | 816.8             |
| 120             | 481.8             |
| 130             | 376.4             |
| 140             | 297.2             |
| 150             | 237.0             |

# **APPENDIX E: RETURNING THE UNIT FOR REPAIR**

In the event that the Sentinel does not function properly, we suggest that you do the following:

- 1) Record your observations regarding the Sentinel's malfunction.
- 2) Call the Technical Service Department at 610-558-2700 prior to sending the unit to Sensaphone for repair.

If the unit must be sent to Sensaphone for Servicing, please do the following:

- 1) Unplug the AC power supply from the wall outlet and disconnect all sensors from the alert zones.
- 2) Carefully pack the unit to avoid damage in transit. Use the original container (if available) or a sturdy shipping box.
- 3) You must include the following information to avoid shipping delays:
  - a) Your name, address and telephone number.
  - b) A note explaining the problem.
- 4) Ship your package to the address below:

SERVICE DEPARTMENT

SENSAPHONE

901 Tryens Road

Aston, PA 19014

- 5) Ship prepaid and insured via UPS or US Mail to ensure a traceable shipment with recourse for damage or replacement.



