

SENSAPHONE®

REMOTE MONITORING SOLUTIONS



Sensaphone 1800 User's Manual

SENSAPHONE®
1800

User's Manual

Version 1.4

Every effort has been made to ensure that the information in this document is complete, accurate and up-to-date. Phonetics, Inc. assumes no responsibility for the results of errors beyond its control. Phonetics, Inc. also cannot guarantee that changes in equipment made by other manufacturers, and referred to in this manual, will not affect the applicability of the information in this manual.

Copyright © 2003 by Phonetics, Inc., dba SENSAPHONE®

First Edition, version 1.4, June 2014

Written and produced by Phonetics, Inc.

Please address comments on this publication to:

Sensaphone
901 Tryens Road
Aston, PA 19014

Sensaphone is a registered trademark of Phonetics, Inc.

Important Safety Instructions

Your Sensaphone 1800 has been carefully designed to give you years of safe, reliable performance. As with all electrical equipment, however, there are a few basic precautions you should take to avoid hurting yourself or damaging the unit:

- Read the installation and operating instructions in this manual carefully. Be sure to save it for future reference.
- Read and follow all warning and instruction labels on the product itself.
- To protect the Sensaphone 1800 from overheating, make sure all openings on the unit are not blocked. Do not place on or near a heat source, such as a radiator or heat register.
- Do not use your Sensaphone 1800 near water, or spill liquid of any kind into it.
- Be certain that your power source matches the rating listed on the AC power transformer. If you're not sure of the type of power supply to your facility, consult your dealer or local power company.
- Do not allow anything to rest on the power cord. Do not locate this product where the cord will be abused by persons walking on it.
- Do not overload wall outlets and extension cords, as this can result in the risk of fire or electric shock.
- Never push objects of any kind into this product through ventilation holes as they may touch dangerous voltage points or short out parts that could result in a risk of fire or electric shock.
- To reduce the risk of electric shock, do not disassemble this product, but return it to Sensaphone Customer Service or another approved repair facility when any service or repair work is required. Opening or removing covers may expose you to dangerous voltages or other risks. Incorrect reassembly can cause electric shock when the unit is subsequently used.
- If anything happens that indicates that your Sensaphone 1800 is not working properly or has been damaged, unplug it immediately and follow the procedures in the manual for having it serviced. Return the unit for servicing under the following conditions:
 1. The power cord or plug is frayed or damaged.
 2. Liquid has been spilled into the product or it has been exposed to water.
 3. The unit has been dropped, or the enclosure is damaged.
 4. The unit doesn't function normally when you're following the operating instructions.
- Avoid using a telephone (other than a cordless type) during an electrical storm. There may be a remote risk of electric shock from lightning.
- Do not use the telephone to report a gas leak in the vicinity of the leak.

CAUTION: To reduce the risk of fire or injury to persons, read and follow these instructions:

1. Replace the battery only with the same or equivalent type recommended by the manufacturer.
2. Do not dispose of the battery in a fire. The cell may explode. Check with local codes for possible special disposal instructions.
3. Do not open or mutilate the battery. Released electrolyte is corrosive and may cause damage to the eyes or skin. It may be toxic if swallowed.
4. Exercise care in handling battery in order not to short the battery with conducting materials such as rings, bracelets, and keys. The battery or conductor may overheat and cause burns.

FCC Requirements

Part 68: The Sensaphone 1800 complies with 47 CFR, Part 68 of the rules. On the back of the unit there is a label that contains, among other information, the Certification Number and the Ringer Equivalence Number (REN) for this equipment. You must, upon request, provide this information to your local telephone company.

The REN is useful to determine the quantity of devices that you may connect to your telephone line and still have all of those devices ring when your telephone number is called. In most, but not all areas, the sum of the REN's of all devices connected to one line should not exceed five (5.0). To be certain of the number of devices that you may connect to your line, you may want to contact your local telephone company to determine the maximum REN for your calling area.

The applicable certification jack USOC for this equipment is: RJ11C. The facility interface code (FIC) for this equipment is: 02LS2.

A compliant telephone cord and modular plug are provided with equipment. This equipment is designated to be connected to the telephone network or premises wiring using a compatible modular jack which is Part 68 compliant. See Installation Instructions for details.

This equipment may not be used on coin service units provided by the telephone company. Connection to party lines is subject to state tariffs. Contact the state public utility commission, public service commission or corporation commission for information.

Should the 1800 cause harm to the telephone network, the telephone company may discontinue your service temporarily. If possible, they will notify you in advance. But if advance notice isn't practical, the telephone company may temporarily discontinue service without notice and you will be notified as soon as possible. You will be informed of your right to file a complaint with the FCC. The telephone company may make changes in its facilities, equipment, operations, or procedures where such action is reasonably required in the operation of its business and is not inconsistent with the rules and regulations of the FCC that could affect the proper functioning of your equipment. If they do, you will be notified in advance to give you an opportunity to maintain uninterrupted telephone service.

If you experience trouble with the 1800, or you need information on obtaining service or repairs, please contact:

Sensaphone
901 Tryens Road
Aston, PA 19014
Toll-Free: 1-877-373-2700
FAX: 610-558-0222

If the equipment is causing harm to the telephone network, the telephone company may ask that you disconnect this equipment from the network until the problem has been corrected or until you are sure that the equipment is not malfunctioning.

Part 15: This equipment has been tested and found to comply with the limits for a Class A digital device, pursuant to Part 15 of the FCC Rules. These limits are designed to provide reasonable protection against harmful interference when the equipment is operated in a commercial environment. This equipment generates, uses and can radiate radio frequency energy and, if not installed and used in accordance with the instructions, may cause harmful interference to radio communications. Operation of this equipment in a residential area is likely to cause harmful interference in which case the user will be required to correct the interference at his own expense.

General Requirements for all Automatic Dialers

When programming emergency numbers and (or) making test calls to emergency numbers:

1. Remain on the line and briefly explain to the dispatcher the reason for the call.
2. Perform such activities in the off-peak hours, such as early morning or late evenings.

Canadian Department of Communications Statement

Notice: The Canadian Department of Communications label identifies certified equipment. This certification means that the equipment meets certain telecommunications network protective operational and safety requirements. The Department does not guarantee the equipment will operate to the user's satisfaction.

Before installing this equipment, users should ensure that it is permissible to be connected to the facilities of the local telecommunications company. The equipment must also be installed using an acceptable method of connection. In some cases, the company's inside wiring associated with a single line individual service may be extended by means of a certified connector assembly (telephone extension cord). The customer should be aware that compliance with the above conditions may not prevent degradation of service in some situations.

Repairs to certified equipment should be made by an authorized Canadian maintenance facility designated by the supplier. Any repairs or alterations made by the user to this equipment, or equipment malfunctions, may give the telecommunications company cause to request the user to disconnect the equipment.

Users should ensure for their own protection that the electrical ground connections of the power utility, telephone lines and internal metallic water pipe system, if present, are connected together. This precaution may be particularly important in rural areas.

CAUTION: Users should not attempt to make such connections themselves, but should contact the appropriate electric inspection authority, or electrician, as appropriate.

The Ringer Equivalence Number (REN) assigned to each terminal device denotes the percentage of the total load to be connected to a telephone loop which is used by the device to prevent overloading. The termination on a loop may consist of any combination of devices subject only to the requirement that the total of the Ringer Equivalent Numbers of all the devices does not exceed 5.0. For Sensaphone 1800, the AC Ringer Equivalent Number is 0.6B.

3 YEAR LIMITED WARRANTY

PLEASE READ THIS WARRANTY CAREFULLY BEFORE USING THE PRODUCT.

THIS LIMITED WARRANTY CONTAINS SENSAPHONE'S STANDARD TERMS AND CONDITIONS. WHERE PERMITTED BY THE APPLICABLE LAW, BY KEEPING YOUR SENSAPHONE PRODUCT BEYOND THIRTY (30) DAYS AFTER THE DATE OF DELIVERY, YOU FULLY ACCEPT THE TERMS AND CONDITIONS SET FORTH IN THIS LIMITED WARRANTY.

IN ADDITION, WHERE PERMITTED BY THE APPLICABLE LAW, YOUR INSTALLATION AND/OR USE OF THE PRODUCT CONSTITUTES FULL ACCEPTANCE OF THE TERMS AND CONDITIONS OF THIS LIMITED WARRANTY (HEREINAFTER REFERRED TO AS "LIMITED WARRANTY OR WARRANTY"). IF YOU DO NOT AGREE TO THE TERMS AND CONDITIONS OF THIS WARRANTY, INCLUDING ANY LIMITATIONS OF WARRANTY, INDEMNIFICATION TERMS OR LIMITATION OF LIABILITY, THEN YOU SHOULD NOT USE THE PRODUCT AND SHOULD RETURN IT TO THE SELLER FOR A REFUND OF THE PURCHASE PRICE. THE LAW MAY VARY BY JURISDICTION AS TO THE APPLICABILITY OF YOUR INSTALLATION OR USE ACTUALLY CONSTITUTING ACCEPTANCE OF THE TERMS AND CONDITIONS HEREIN AND AS TO THE APPLICABILITY OF ANY LIMITATION OF WARRANTY, INDEMNIFICATION TERMS OR LIMITATIONS OF LIABILITY.

1. **WARRANTOR:** In this Warranty, Warrantor shall mean "Dealer, Distributor, and/or Manufacturer."

2. **ELEMENTS OF WARRANTY:** This Product is warranted to be free from defects in materials and craftsmanship with only the limitations and exclusions set out below.

3. **WARRANTY AND REMEDY:** Three-Year Warranty — In the event that the Product does not conform to this warranty at any time during the time of three years from original purchase, warrantor will repair the defect and return it to you at no charge.

This warranty shall terminate and be of no further effect at the time the product is: (1) damaged by extraneous cause such as fire, water, lightning, etc. or not maintained as reasonable and necessary; or (2) modified; or (3) improperly installed; or (4) misused; or (5) repaired or serviced by someone other than Warrantors' authorized personnel or someone expressly authorized by Warrantor's to make such service or repairs; (6) used in a manner or purpose for which the product was not intended; or (7) sold by original purchaser.

LIMITED WARRANTY, LIMITATION OF DAMAGES AND DISCLAIMER OF LIABILITY FOR DAMAGES: THE WARRANTOR'S OBLIGATION

UNDER THIS WARRANTY IS LIMITED TO REPAIR OR REPLACEMENT OF THE PRODUCT, AT THE WARRANTOR'S OPTION AS TO REPAIR OR REPLACEMENT. IN NO EVENT SHALL WARRANTORS BE LIABLE OR RESPONSIBLE FOR PAYMENT OF ANY INCIDENTAL, CONSEQUENTIAL, SPECIAL AND/OR PUNITIVE DAMAGES OF ANY KIND, INCLUDING BUT NOT LIMITED TO ANY LABOR COSTS, PRODUCT COSTS, LOST REVENUE, BUSINESS INTERRUPTION LOSSES, LOST PROFITS, LOSS OF BUSINESS, LOSS OF DATA OR INFORMATION, OR FINANCIAL LOSS, FOR CLAIMS OF ANY NATURE, INCLUDING BUT NOT LIMITED TO CLAIMS IN CONTRACT, BREACH OF WARRANTY OR TORT, AND WHETHER OR NOT CAUSED BY WARRANTORS' NEGLIGENCE. IN THE EVENT THAT IT IS DETERMINED IN ANY ADJUDICATION THAT THE LIMITED WARRANTIES OF REPAIR OR REPLACEMENT ARE INAPPLICABLE, THEN THE PURCHASER'S SOLE REMEDY SHALL BE PAYMENT TO THE PURCHASER OF THE ORIGINAL COST OF THE PRODUCT, AND IN NO EVENT SHALL WARRANTORS BE LIABLE OR RESPONSIBLE FOR PAYMENT OF ANY INCIDENTAL, CONSEQUENTIAL, SPECIAL AND/OR PUNITIVE DAMAGES OF ANY KIND, INCLUDING BUT NOT LIMITED TO ANY LOST REVENUE, BUSINESS INTERRUPTION LOSSES, LOST PROFITS, LOSS OF BUSINESS, LOSS OF DATA OR INFORMATION, OR FINANCIAL LOSS, FOR CLAIMS OF ANY NATURE, INCLUDING BUT NOT LIMITED TO CLAIMS IN CONTRACT, BREACH OF WARRANTY OR TORT, AND WHETHER OR NOT CAUSED BY WARRANTORS' NEGLIGENCE.

WITHOUT WAIVING ANY PROVISION IN THIS LIMITED WARRANTY, IF A CIRCUMSTANCE ARISES WHERE WARRANTORS ARE FOUND TO BE LIABLE FOR ANY LOSS OR DAMAGE ARISING OUT OF MISTAKES, NEGLIGENCE, OMISSIONS, INTERRUPTIONS, DELAYS, ERRORS OR DEFECTS IN WARRANTORS' PRODUCTS OR SERVICES, SUCH LIABILITY SHALL NOT EXCEED THE TOTAL AMOUNT PAID BY THE CUSTOMER FOR WARRANTORS' PRODUCT AND SERVICES OR \$250.00, WHICHEVER IS GREATER. YOU HEREBY RELEASE WARRANTORS FROM ANY AND ALL OBLIGATIONS, LIABILITIES AND CLAIMS IN EXCESS OF THIS LIMITATION.

INDEMNIFICATION AND COVENANT NOT TO SUE: YOU WILL INDEMNIFY, DEFEND AND HOLD HARMLESS WARRANTORS, THEIR OWNERS, DIRECTORS, OFFICERS, EMPLOYEES, AGENTS, SUPPLIERS OR AFFILIATED COMPANIES, AGAINST ANY AND ALL CLAIMS, DEMANDS OR ACTIONS BASED UPON ANY LOSSES, LIABILITIES, DAMAGES OR COSTS, INCLUDING BUT NOT LIMITED TO DAMAGES THAT ARE DIRECT OR INDIRECT, INCIDENTAL, SPECIAL OR CONSEQUENTIAL, AND INCLUDING ATTORNEYS FEES AND LEGAL COSTS, THAT MAY RESULT FROM THE INSTALLATION, OPERATION, USE OF, OR INABILITY TO USE WARRANTORS' PRODUCTS AND SERVICES, OR FROM THE FAILURE OF THE WARRANTORS' SYSTEM

TO REPORT A GIVEN EVENT OR CONDITION, WHETHER OR NOT CAUSED BY WARRANTORS' NEGLIGENCE.

YOU AGREE TO RELEASE, WAIVE, DISCHARGE AND COVENANT NOT TO SUE WARRANTORS, THEIR OWNERS, DIRECTORS, OFFICERS, EMPLOYEES, AGENTS, SUPPLIERS OR AFFILIATED COMPANIES, FOR ANY AND ALL LIABILITIES POTENTIALLY ARISING FROM ANY CLAIM, DEMAND OR ACTION BASED UPON ANY LOSSES, LIABILITIES, DAMAGES OR COSTS, INCLUDING BUT NOT LIMITED TO DAMAGES THAT ARE DIRECT OR INDIRECT, INCIDENTAL, SPECIAL OR CONSEQUENTIAL, AND INCLUDING ATTORNEYS FEES AND LEGAL COSTS, THAT MAY RESULT FROM THE INSTALLATION, OPERATION, USE OF, OR INABILITY TO USE WARRANTORS' PRODUCTS AND SERVICES, OR FROM THE FAILURE OF THE WARRANTORS' SYSTEM TO REPORT A GIVEN EVENT OR CONDITION, WHETHER OR NOT CAUSED BY WARRANTORS' NEGLIGENCE, EXCEPT AS NECESSARY TO ENFORCE THE EXPRESS TERMS OF THIS LIMITED WARRANTY.

EXCLUSIVE WARRANTY: THE LIMITED WARRANTY OR WARRANTIES DESCRIBED HEREIN CONSTITUTE THE SOLE WARRANTY OR WARRANTIES TO THE PURCHASER. ALL IMPLIED WARRANTIES ARE EXPRESSLY DISCLAIMED, INCLUDING: THE WARRANTY OF MERCHANTABILITY AND THE WARRANTY OF FITNESS FOR A PARTICULAR USE AND THE WARRANTY OF FITNESS FOR A PARTICULAR PURPOSE AND THE WARRANTY OF NON-INFRINGEMENT AND/OR ANY WARRANTY ARISING FROM A COURSE OF DEALING, USAGE, OR TRADE PRACTICE.

It must be clear that the Warrantors are not insuring your premises or business or guaranteeing that there will not be damage to your person or property or business if you use this Product. You should maintain insurance coverage sufficient to provide compensation for any loss, damage, or expense that may arise in connection with the use of products or services, even if caused by Warrantors' negligence. The warrantors assume no liability for installation of the Product and/or interruptions of the service due to strikes, riots, floods, fire, and/or any cause beyond Seller's control, further subject to the limitations expressed in any License Agreement or other Agreement provided by Warrantors to purchaser.

The agreement between the Warrantors and the Purchaser, including but not limited to the terms and conditions herein shall not be governed by the Convention for the International Sale of Goods. Where applicable, the Uniform Commercial Code as adopted by the State of Delaware shall apply.

4. PROCEDURE FOR OBTAINING PERFORMANCE OF WARRANTY: In the event that the Product does not conform to this warranty, the Product should be shipped or delivered freight prepaid to a Warrantor with evidence of original purchase.

5. LEGAL REMEDIES AND DISCLAIMER: Some jurisdictions may not allow, or may place limits upon, the exclusion and/or limitation of implied warranties, incidental damages and/or consequential damages for some types of goods or products sold to consumers and/or the use of indemnification terms. Thus, the exclusions, indemnification terms and limitations set out above may not apply, or may be limited in their application, to you. If the implied warranties can not be excluded, and the applicable law permits limiting the duration of implied warranties, then the implied warranties herein are to be limited to the same duration as the applicable written warranty or warranties herein. The warranty or warranties herein may give you specific legal rights that will depend upon the applicable law. You may also have other legal rights depending upon the law in your jurisdiction.

6. CHOICE OF FORUM AND CHOICE OF LAW: In the event that a dispute arises out of or in connection with this Limited Warranty, then any claims or suits of any kind concerning such disputes shall only and exclusively be brought in either the Court of Common Pleas of Delaware County, Pennsylvania or the United States District Court for the Eastern District of Pennsylvania.

Regardless of the place of contracting or performance, this Limited Warranty and all questions relating to its validity, interpretation, performance and enforcement shall be governed by and construed in accordance with the laws of the State of Delaware, without regard to the principles of conflicts of law.

Effective date 04/01/2006
PHONETICS, INC. d.b.a. SENSAPHONE
901 Tryens Road
Aston, PA 19014
Phone: 610.558.2700 Fax: 610.558.0222
www.sensaphone.com

Table of Contents

Important Safety Instructions	iii
FCC Requirements	v
Canadian Department of Communications Statement	vii
3 YEAR LIMITED WARRANTY	ix
CHAPTER 1: INTRODUCTION	17
FEATURES	18
LAYOUT	19
TECHNICAL SUPPORT	20
CHAPTER 2: INSTALLATION	21
OPERATING ENVIRONMENT	21
Mounting the 1800	21
Locking the Enclosure	22
Grounding	22
TURNING THE 1800 ON	24
Backup Battery	24
TELEPHONE LINE	25
Line Seizure	25
WIRING SENSORS AND TRANSDUCERS	26
Wiring Recommendations	27
LED INDICATORS	28
CHAPTER 3: QUICK START GUIDE	29
HOW THE KEYPAD COMMANDS WORK	29
ABORTING A COMMAND	29
ERROR MESSAGES	29
ACKNOWLEDGING A FALSE ALARM	30
RECOMMENDED PROGRAMMING STEPS	30
CHAPTER 4: ZONE PROGRAMMING	31
CONFIGURE ZONE TYPE	31
MANUAL ZONE CONFIGURATION	32

ENABLE/DISABLE ZONE ALARMS 34
ENABLE/DISABLE SOUND LEVEL ALARM 35
ENABLE/DISABLE POWER 36
CONFIGURE TEMPERATURE SCALE 37
CONFIGURE TABLE RANGE FOR 4–20mA SENSORS . . . 38
ALARM RECOGNITION TIME 41
ALARM LIMITS 44
ZONE CALIBRATION 47
SOUND LEVEL CALIBRATION 49
DESIGNATING A ZONE AS UNUSED 51
EXIT DELAY 52
TEMPERATURE-ONLY STATUS REPORT 53

CHAPTER 5: COMMUNICATION PROGRAMMING 54

DATE and TIME 54
VOICE MESSAGES 56
ID NUMBER 59
ALARM DIAL-OUT TELEPHONE NUMBERS 61
 Voice Dialout 61
 Numeric Pager Dialout 63
 Alphanumeric Pager Dialout 66
SPECIAL DIALING OPTIONS 70
 Blind Dialing 71
DIAL-OUT TEST MODE 72
ALARM ACKNOWLEDGMENT CODES 73
ALARM HISTORY 75
 Deleting the Alarm History 75
TONE OR PULSE DIALING 76
RINGS UNTIL ANSWER 77
CALL DELAY TIME 78
INTERCALL TIME 80
CALL PROGRESS 82
VOICE REPETITIONS 83
MAX CALLS 84

TELEPHONE ANSWERING DEVICE (TAD) COMPATIBILITY 85
LISTEN-IN TIME. 86
LOCKING THE KEYPAD 87
SPEAKER MUTE 88
CALLBACK ACKNOWLEDGMENT. 89

CHAPTER 6: CONTROLLING THE OUTPUT 90
AUTOMATIC MODES. 90
MANUAL MODE 91

CHAPTER 7: OPERATION. 94
ALARM DIALOUT AND ACKNOWLEDGMENT. 94
 Alarm Recognition. 94
 Alarm Notification. 94
 Dialout Note: Call Progress 94
 Alarm Dialout—Voice 94
 Alarm Dialout—Pager 95
 Alarm Dialout—Alphanumeric Pager 95
ALARM ACKNOWLEDGMENT 96
 Alarm Acknowledgment—Voice Dialout. 96
 Alarm Acknowledgment—Numeric Pager Dialout . . . 96
 Alarm Acknowledgment—Alphanumeric Pager Dialout 98
 Alarm Acknowledgment—Automatic (Max Calls) . . . 99
CALL-IN STATUS 100
REMOTE COMMANDS VIA TOUCH-TONE PHONE 101

**APPENDIX A: Checking Your 1800
 for Proper Operation 106**

APPENDIX B: Replacing the Back-up Battery . . 108

APPENDIX C: Troubleshooting the 1800 110
COMMUNICATIONS/DIAL-OUT: 111
TEMPERATURE MONITORING:. 114
4–20mA MONITORING:. 116

SOUND LEVEL MONITORING:	117
OTHER MONITORING:	118
APPENDIX D: 2.8 and 10K Thermistor Tables .	120
APPENDIX E: 1800 Technical Specifications . . .	122
APPENDIX F: 1800 Quick Reference Guide . . .	124
APPENDIX G: Accessories	128
APPENDIX H: Returning Your 1800 for Repair .	129
Test Log	130

CHAPTER 1: INTRODUCTION

Congratulations on your purchase of the Sensaphone 1800. The 1800 is a powerful monitoring, alarm, and event logging system. It can monitor equipment and environmental conditions using eight universal Zones, built-in power failure detection, and sound level monitoring. The Sensaphone 1800 also features several communication options: user-recordable voice, numeric pager, and alphanumeric pager (wireless phone text message). The 1800 is the ultimate choice for multi-zone industrial monitoring applications.

The Sensaphone 1800 is a fully programmable environmental monitoring system for unattended or remote applications. The unit will monitor and alarm on eight zones: N.O./N.C.(Normally Open or Normally Closed) contact, 2.8K or 10K thermistor (temperature sensor), and 4–20mA transducer. The unit will also monitor AC power, sound level, and battery condition. On the front of the unit are LED indicators to show the operating status. Each zone (including power, sound and battery) has a status LED indicating the alarm status of the Zone. There is also an LED to indicate if the Output is On, an LED for Phone In-Use status and an LED for System-On status.

The unit is programmed using the built-in keypad and voice response menus. All programming is stored in nonvolatile memory so that all programming is retained even without power. The unit is capable of performing alarm event logging of the eight universal Zones, power, and sound. The event logging (history) is also stored in nonvolatile memory. A battery-backed real-time clock is also included to time-stamp logged events. The alarm event history can be heard through the built-in speaker or remotely over the telephone. A complete status report of all monitored conditions can also be heard simply by calling the 1800.

The unit comes in a plastic NEMA-4 enclosure with tabs for wall or panel mounting. Terminal connections for Zones, outputs and power are easily accessible from the front of the unit. The 1800 is powered by a plug-in adapter and has a 2.2AH rechargeable backup battery located behind the panel. Circuitry in the unit will maintain precise charging of the battery system. The unit also includes Line

Seizure capability to ensure that the telephone line is available when necessary (See optional Line Seizure Kit # FGD-0060).

FEATURES

The Sensaphone 1800 includes the following features:

- Eight Zones configurable as temperature, 4–20mA or dry contact
- Calibration for each Zone
- Each Zone can be individually enabled or disabled
- Power monitor
- High sound-level monitor (w/optional external mic)
- 1 relay output (manual or automatic control)
- 14 status LEDs
- Dial out to eight telephone numbers
- User-recordable voice messages
- Alarm dialout via voice, numeric pager and alphanumeric pager (wireless phone text message)
- Line Seizure via optional kit (FGD-0060)
- Microphone for on-site listen-in (w/optional external mic)
- Time-stamped Alarm History
- Superior surge/lightning protection on all Zones, telephone line and power supply
- 12-hour rechargeable battery backup
- NEMA-4 enclosure

LAYOUT

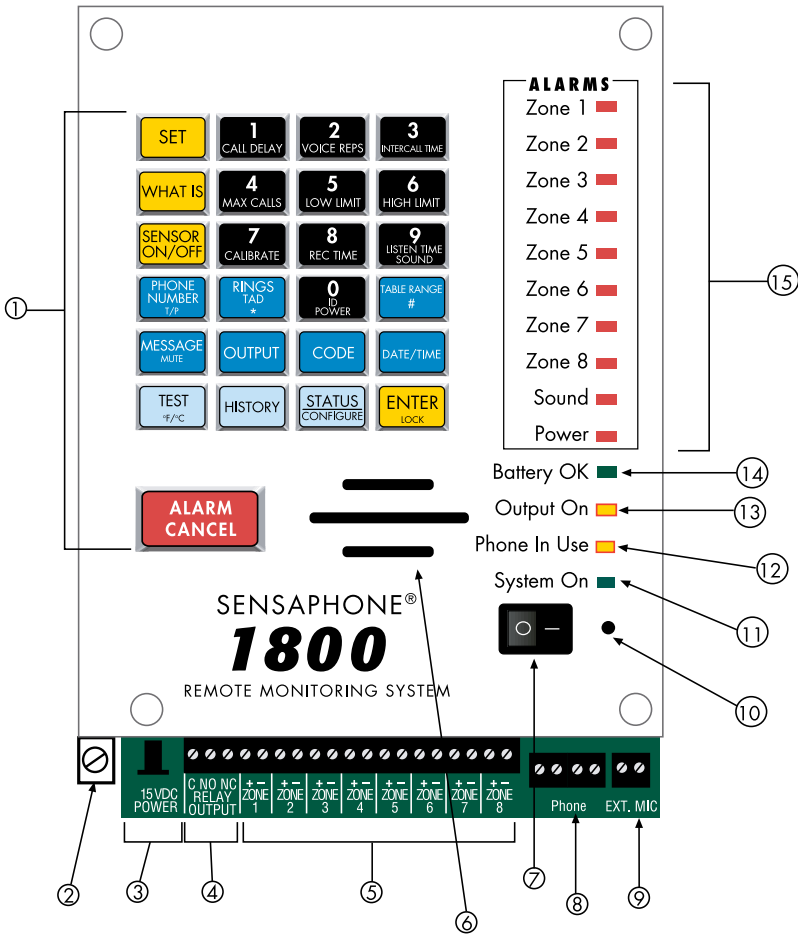

Figure 1: Sensaphone 1800 diagram

- | | |
|--|--|
| <ol style="list-style-type: none"> 1. Programming Keypad 2. Grounding Lug 3. 15VDC Power Jack 4. N.O./N.C. Relay Output Terminals 5. 8 Zone Terminals 6. Speaker Grille 7. Power Button 8. Phone Network/Extension Terminals | <ol style="list-style-type: none"> 9. External Mic Terminals 10. Built-in Condenser Mic 11. System On LED 12. Phone-in-use LED 13. Output On LED 14. Battery OK LED 15. Zone Alarm LEDs |
|--|--|

TECHNICAL SUPPORT

Reading this instruction manual will help you install and program the 1800. Programming and voice recording are performed locally using the built-in keypad. Some programming can also be accessed via touch-tone phone.

If there are any questions or problems that arise upon installation or operation, please contact Technical Support at:

Sensaphone
901 Tryens Road
Aston, PA 19014
Toll-Free Phone: 1-877-373-2700
FAX: 610-558-0222
support@sensaphone.com

CHAPTER 2: INSTALLATION

OPERATING ENVIRONMENT

The Sensaphone 1800 should be mounted and operated in a clean, dry environment. The unit is microprocessor-controlled and as a result it should not be installed near devices that generate strong electromagnetic fields. Such interference is typically generated by power switching equipment such as relays or contactors. A poor operating environment may result in unwanted system resets and/or system lockup. The temperature range the unit can operate in is 32°F to 122°F (0°C to 50°C). If the unit needs to operate below freezing, a heater should be installed nearby.

Mounting the 1800

The NEMA-4 enclosure housing the 1800 comes with hardware for wall or panel mounting. The four tabs are attached by screwing the round bubble-end of a tab to each of the four rear corners of the enclosure. Then mount the unit in a position that allows easy access to the Zone terminal block and keypad. Also, there must be a power outlet and telephone jack close to the unit.

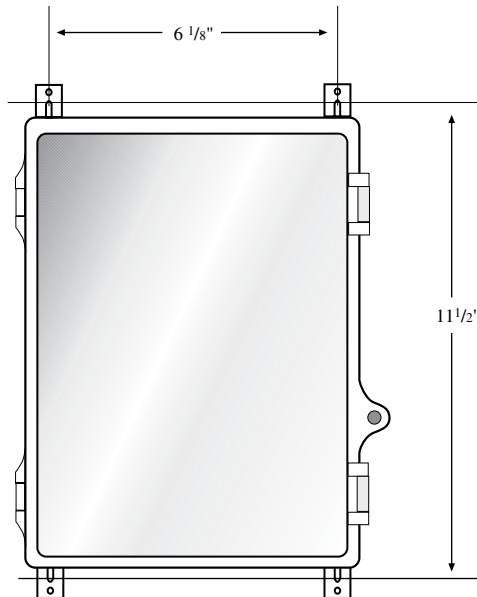

Figure 1: Mounting Dimensions

Locking the Enclosure

The 1800 enclosure can be locked by installing a small padlock through the loop on the front door of the enclosure. See Figure below.

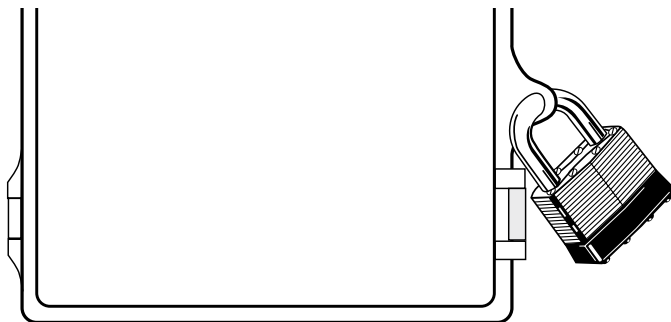

Figure 2: Locking the Enclosure

Grounding

Connect a heavy gauge (#10AWG) copper wire to the earth ground lug on the left end of the panel and connect the other end to a ground rod or metal cold water pipe (See Figure 3). It is extremely important that the earth ground connection be as short as possible. The ground rod should have sufficient depth to provide a low impedance connection to earth. This connection is required for the surge/lightning protection circuits to function properly.

NOTE: Proper earth grounding of the 1800 is required for warranty coverage.

Ground rods can typically be found at local electrical supply houses and/or hardware stores. Be sure to contact your state “*Call before you dig*” hotline at least **two** days before you install your ground rod, to insure that it is safe to install the ground rod in a chosen area.

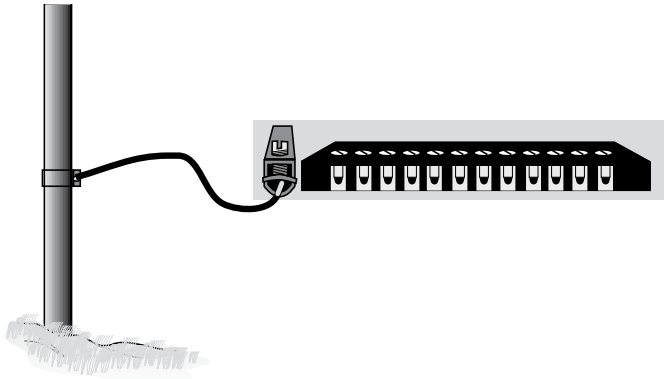

Figure 3: Grounding the 1800

Wiring Connectors

The 1800 includes compression-type liquid-tight connectors for routing wires into the enclosure. To use these connectors, turn them *counter-clockwise to loosen* (or open-up) the compression washer. Insert all cables through the two connectors. When finished turn them *clockwise to secure and seal* the 1800 from the outside environment. If you don't have enough cables to obtain a snug fit you can insert a small piece of soft PVC insulation or rubber tubing to take up the extra space.

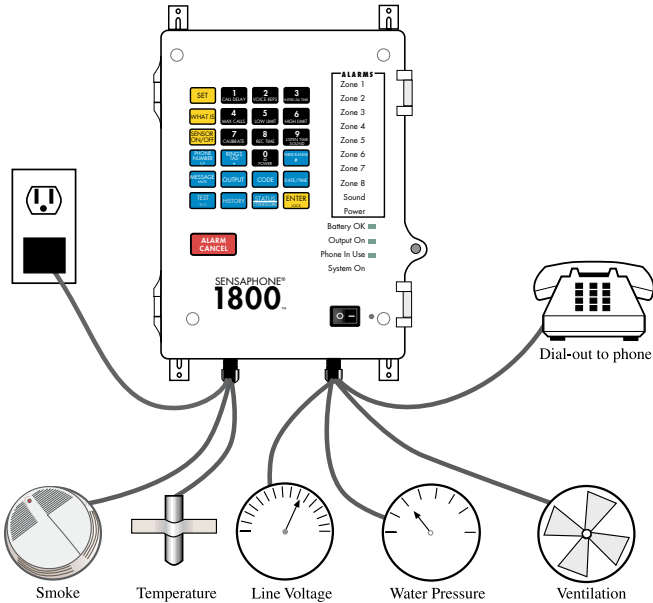

Figure 4: Typical connections from 1800

TURNING THE 1800 ON

Plug the unit's transformer into a 120VAC 60Hz outlet. Toggle the power switch to ON to start the unit. The System-On LED should glow steadily and the unit will say "Hello."

Note that when the unit is turned off, all programming is retained in non-volatile memory.

Backup Battery

The Sensaphone 1800 includes a 12V 2.2AH sealed lead-acid gel-cell rechargeable battery for system back-up in the event of a power failure. The battery will provide approximately 12 hours of backup time. Actual backup time will depend upon the temperature, battery age, and dialing activity. The battery is located behind the main panel.

The 1800 will automatically charge the battery whenever the power switch is turned on and the power transformer is plugged in. The unit also includes special circuitry to prevent the battery from being damaged in the event of an extended power outage. The battery should provide about 5 years of service before needing replacement. See Appendix B for battery replacement instructions.

The 1800 also includes a 3V lithium battery to retain the date and time when main power is off. The lithium battery should provide 8-10 years of service life.

NOTE: Have batteries serviced by qualified service personnel only.

TELEPHONE LINE

Connect the 1800's Phone jack to a standard 2-wire analog phone line. The unit dials using pulse or tone, with loop start only. The 1800 will recognize ringer frequencies from 16 to 60 Hz and will operate with all standard analog telephone systems that accept pulse or tone dialing.

Certain private telephone systems and public switching equipment may not accept the unit's dialing or may generate an unacceptable ring signal. In those cases, a dedicated line may be required for the unit. Consult the supplier of your telephone system if you encounter problems.

CAUTION: Never install telephone wiring during a lightning storm. Never install telephone jacks in wet locations unless the jack is specifically designed for wet locations. Never touch uninsulated telephone wires or terminals unless the telephone line has been disconnected at the network interface. Use caution when installing or modifying telephone lines.

Line Seizure

Line seizure gives the 1800 the ability to "seize" the telephone line when it needs to dial out. For example, if an emergency occurs which puts the 1800 in alarm mode, the unit will be able to dial out even if a telephone has been left off the hook. To the right of the LINE terminals is another set of terminals labeled EXT.

These terminals can be used to share the line with other devices (telephone, fax machine, modem) and to give the 1800 priority in the event of an emergency. To make use of this feature you must have all the extension devices originate from the EXT. terminals. Whenever the unit must make an alarm phone call, the unit will disconnect any current phone calls and seize the line for its own use. The unit will continue to seize the line until the alarm has been acknowledged. To ease installation, an optional accessory is available (FGD-0060 Line Seizure Kit) which provides an RJ31x modular wall jack, cable, and wiring instructions.

NOTE: The Line Seizure Kit is *not* required for the 1800 seizure capability to function correctly. The Kit allows the disconnection of the 1800 system from the telephone line while ensuring continued telephone operation—useful if the 1800 is, for instance, temporarily removed for service.

WIRING SENSORS AND TRANSDUCERS

The 1800 Zones are compatible with NO/NC dry contacts, 10K thermistors, and 4–20mA transducers. To prevent an alarm from occurring while wiring the sensors, it is recommended that the zone be disabled [SENSOR ON/OFF] + [Zone #1–8]. After wiring all of your sensors you will need to configure the zones using the [SET] + [CONFIGURE] command. See Chapter 4 for more information on Disabling sensors and Configuring Zones.

Recommended sequence for adding a new sensor:

1. Disable the zone.
2. Wire up the sensor.
3. Configure the zone.
4. Enable the zone.

NOTE: If a false alarm occurs while wiring a sensor, you can quickly acknowledge it by pressing the [ALARM/CANCEL] key and entering [11234] + [ENTER]. This is the default acknowledgment code for user #1. See Chapter 5 for more information on User Acknowledgment Codes.

Temperature: The unit will accept 10K or 2.8K thermistors. These should be wired to a Zone terminal and the adjacent ground

terminal. For recommended thermistors check the accessory list or thermistor data in the appendices. Temperature range for 2.8K thermistors is -109° to 115°F (-85° to 57°C). The temperature range for 10K thermistors is -87° to 168°F (-66° to 76°C)

Dry Contacts: Only contacts which have no voltage or current applied may be used. Connect the contact to a Zone terminal and an adjacent ground terminal. Do NOT try to monitor a contact that switches 120VAC. This will permanently damage the unit.

4–20mA: A 4–20mA transducer requires you to have an external DC power supply for the transducer. Connect the positive wire of your transducer to the positive terminal of your DC power supply. Connect the negative terminal of the transducer to a Zone terminal on the Sensaphone 1800. Connect the negative terminal from your power supply to the adjacent ground terminal on the 1800.

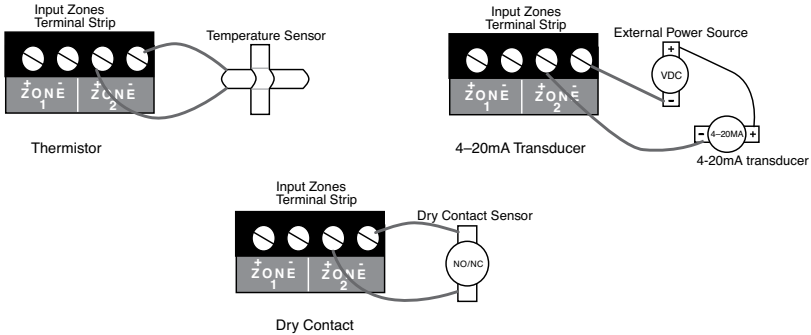

Figure 5: Different Sensor Types connected to the Terminal Block

Wiring Recommendations

The 1800 will work fine in indoor environments using unshielded cable. When wiring will be subject to long lengths (>250') or if run outdoors, it is highly recommended that shielded cable be used and that the shield be connected to an earth ground. Also, be sure to use the appropriate gauge wire based on the distance and sensor type. See chart below:

Wire Gauge	Thermistor	NO/NC Contact & 4–20mA
#24	250'	1000'
#22	500'	2000'
#20	1000'	4000'

When preparing wire for connection to the terminal blocks, strip $\frac{1}{4}$ " of insulation from the conductor (see figure below)



Figure 6: Wire stripped for connection

LED INDICATORS

The LEDs provide on-site alarm and status information. Listed below are descriptions of how the LEDs work.

Zones 1–8, Power and Sound:

LED Off: Zone OK

LED Blinking Fast: Alarm condition exists but recognition time has not been met

LED Blinking Slowly: Unacknowledged alarm exists

LED On: Acknowledged alarm exists

Battery:

LED On: Battery OK

LED Blinking: Battery condition low

Output On:

LED On: Output relay on

LED Off : Output relay off

Phone-In-Use:

LED On: Unit is communicating on the phone line

LED Off: Unit is not using the phone line

System-On:

LED On: System power on

LED Off : System power off

CHAPTER 3: QUICK START GUIDE

This section presents a brief guide and some helpful hints for first-time users of the 1800. Follow the instructions for installation before attempting to program the unit.

HOW THE KEYPAD COMMANDS WORK

The 1800 uses simple keypad commands to program and listen to all pertinent parameters. All of the keypad commands begin with either the SET, WHAT IS, or SENSOR ON/OFF keys. The SET key is used to program parameters. When performing a programming sequence, the command will typically require the SET key followed by the parameter to be programmed, followed by a value, and then the ENTER key at the end. For example, to program the Call Delay you would press [SET] + [CALL DELAY] + [value] + [ENTER]. To check your programming, you would press the WHAT IS key followed by the parameter (in this case, [WHAT IS] + [CALL DELAY]).

The SENSOR ON/OFF key is generally used to enable and disable functions or to toggle a function on and off. For example, to disable a Zone you would press [SENSOR ON/OFF] + [Zone #] or to turn the speaker Mute on you would press [SENSOR ON/OFF] + [MESSAGE/MUTE].

ABORTING A COMMAND

If you are in the middle of a command and you make a mistake, you can abort the command by either pressing the ALARM CANCEL key or by simply waiting for the command to time out (typically 30 seconds). When you abort a command, the unit will say “Error 1” to indicate that the command has not been executed successfully.

ERROR MESSAGES

When programming parameters in the 1800 you may get an error message if you inadvertently enter an incorrect value. If the unit says “Error 1,” it means that you entered a value that is out of range

or have aborted the command. If the unit says “Error 2,” it means that the keypad is locked and must be unlocked to perform the function.

ACKNOWLEDGING A FALSE ALARM

While programming the unit you may inadvertently set off an alarm. Once an alarm occurs, the unit will start its alarm processing routine, which will prevent you from performing any other keypad function until the alarm is acknowledged. To acknowledge an alarm and stop the unit from making any phone calls, press [ALARM CANCEL] + [11234] + [ENTER]. This will acknowledge the alarm, using the default Acknowledgement Code for user #1. If you have changed the default acknowledgment code, then enter the new code as required.

RECOMMENDED PROGRAMMING STEPS

Listed below are the basic programming steps to get you up and running. The chapters that follow provide detailed programming instructions as well as additional options to customize the operation of your 1800.

Parameter	Page #
1. Set the Date & Time	55
2. Configure Zones	31
3. Set Alarm Limits	44
4. Record Zone voice messages	58
5. Record ID voice message	57
6. Set ID number	60
7. Set dialout telephone numbers	62

CHAPTER 4: ZONE PROGRAMMING

This chapter explains the keyboard commands for the monitoring functions of the 1800. This includes:

- Configure Zone Type
- Enable/disable Zones
- Temperature Scale
- Table Range for 4-20mA sensors
- Alarm Recognition Time
- Alarm Limits
- Zone Calibration
- AC Power Monitoring Enable/disable
- AC Power Recognition Time
- Sound Level Monitoring Enable/disable
- Sound Level Recognition Time
- Sound Level Calibration

CONFIGURE ZONE TYPE

The 1800 is compatible with normally open, normally closed, 10K thermistor (temperature), 2.8K thermistor (temperature), and 4–20mA type sensors. All of the Zones are configured simultaneously by keying in a simple key sequence after connecting all of your sensors. Make sure all sensors are in their normal state. All 4–20mA transducers should be powered on.

NOTE: Temperature sensors will default configure to 2.8K. If you are connecting any 10K sensors to the 1800, these **must** be configured manually. (*See the Manual Configuration section*)

To configure the Zone Types:

1. Press the SET key.



2. Press the CONFIGURE key.

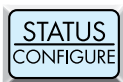

The 1800 will announce each Zone number and its detected Zone type.

The Zones are now considered normal. If a normally closed Zone becomes open, an alarm will occur. If a normally open Zone becomes closed, an alarm will occur.

MANUAL ZONE CONFIGURATION

If you would like to program the Zone type (NO, NC, temperature, 4–20mA) without going through the automatic process that scans all Zones, this command will allow you to configure a single Zone. This command is useful if you have alarms on other channels and cannot use the automatic configuration process, or if you wish to configure the Zone type without actually connecting the sensor.

NOTE: You **MUST** use manual configuration for any zone connecting to a 10K temperature sensor.

To configure the Zone Type:

1. Press the SENSOR ON/OFF key.



2. Press the TABLE RANGE key.



The 1800 will say “Enter Number.”

3. Press the corresponding Zone key (1–8).

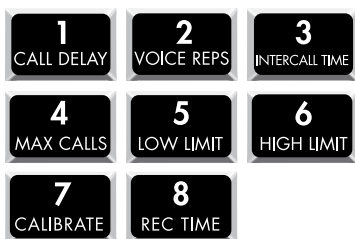

The 1800 will say “Enter Mode.”

4. Press the key which corresponds to the type of Zone according to the table below:

- 1: NC Dry Contact
- 2: NO Dry Contact
- 3: 10K Thermistor (temperature sensor)
- 4: 4–20mA
- 5: Not applicable
- 6: 2.8K Thermistor (temperature sensor)

5. Press ENTER.



ENABLE/DISABLE ZONE ALARMS

This function allows you to enable or disable a Zone (1-8) for dialout during an alarm. An enabled Zone will respond to an alarm and allow dialout. A disabled Zone will not initiate a dialout, but it will still be included in the status report, preceded by the word “off.” This command is useful while you are wiring your Zones or at any other time you would like the alarms to be ignored. The default setting for all Zones is enabled (*on*).

To enable/disable Zones:

1. Press the SENSOR ON/OFF key.



2. Press the corresponding number key (1-8) of the Zone you want to enable/disable. 1800 will say “Off” to indicate disabled or “On” to indicate enabled.

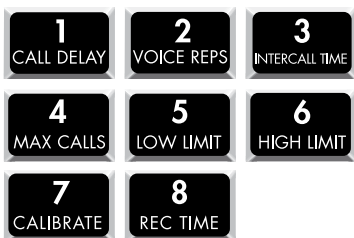

3. Repeat key sequence to change.

ENABLE/DISABLE SOUND LEVEL ALARM

This function allows you to enable or disable the sound alarm for dialout. When enabled, a high sound level at the remote microphone (optional)—*that meets the programmed recognition time and level*—will trip a sound alarm and the unit will dial out. Disabling sound will prevent a sound alarm dialout status report. The default setting is enabled (*on*).

To enable/disable sound:

1. Press the SENSOR ON/OFF key.



2. Press the Sound Alarm key (9). 1800 will say “Off” to indicate disabled or “On” to indicate enabled.



3. Repeat the steps to change.

ENABLE/DISABLE POWER

This function allows you to enable or disable AC power failure monitoring (0). Enabled AC power monitoring will respond to an alarm and allow dialout. Disabled AC power monitoring will not initiate a dialout status report. The default setting is enabled (*on*).

To enable/disable power:

1. Press the SENSOR ON/OFF key.



2. Press the power key (0) to enable/disable. 1800 will say "Off" to indicate disabled or "On" to indicate enabled.



3. Repeat the steps to change.

CONFIGURE TEMPERATURE SCALE

The 1800 can read temperature in degrees Fahrenheit or Celsius. The default is degrees Fahrenheit.

To change the Temperature Scale:

1. Press the SENSOR ON/OFF key.



2. Press the F/C key.



The 1800 will say “degrees F” or “degrees C” to indicate the current setting. Repeat the key sequence to change.

CONFIGURE TABLE RANGE FOR 4–20mA SENSORS

The 1800 allows you to create a unique linear table for each 4–20mA sensor Zone. The Table Low (4mA) and Table High (20mA) values are used to define the upper and lower range of your 4–20mA sensor. For example, suppose you are using a 4–20mA transducer to measure the depth of water in a 15 foot well. Simply enter a Table Low value of 0 and a Table High value of 15 and the 1800 will scale the Zone to read between 0 and 15. The low and high table range can be set from -10,000 to + 10,000. To make a value negative, precede the value with the [RINGS/TAD/*] key.

To configure the Table Low and High Range:

1. Press the SET key.



2. Press the TABLE RANGE key.

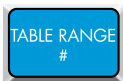

3. Press the corresponding Zone number (1–8). 1800 will say “Enter Low Number.”

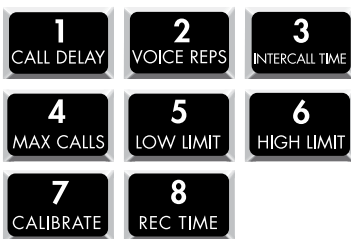

4. Using the number keys, enter the Table Low value, then press ENTER.

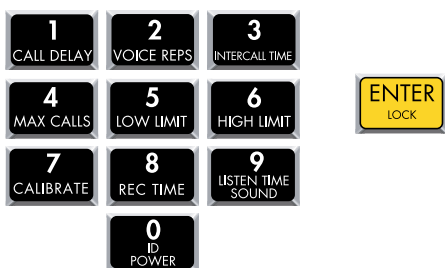

The 1800 will say “Enter High Number.”

5. Using the number keys, enter the Table High value and press ENTER.



The 1800 will say “OK.”

To play back the Table Low and Table High Range:

1. Press the WHAT IS key.



2. Press the TABLE RANGE key.



3) Press the corresponding Zone number (1–8).

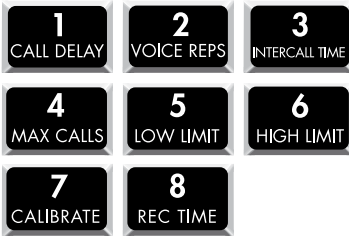

The 1800 will say “Low” then speak the value, then 1800 will say “High” and speak the value.

ALARM RECOGNITION TIME

The Alarm Recognition Time is the length of time an alert condition must be present before a valid alarm exists and dial-out is activated. If a condition exists and then clears within the recognition time, it is not considered an alarm. This is useful to prevent nuisance dialouts for momentary alarm conditions or on self-correcting equipment. Each Zone can be programmed with a different recognition time, including power alarms and Sound Level Alarms. The default recognition time is 3 seconds for Zones, 5 minutes for Power, and 8 seconds for Sound level. You may program the recognition time for Zone and Power alarms from 0 seconds up to 272 minutes. Sound level alarms may be programmed from 5 to 60 seconds.

NOTE: When the main power fails, the 1800 will announce out loud “Power is OFF” every 15 seconds. It will do this regardless of the programmed recognition time. As a result, when the programmed recognition time is finally met, the unit will dial immediately and not wait the programmed Call Delay time. The Power Alarm is the *only* one treated in this fashion.

To program the Alarm Recognition Time:

1. Press the SET key.



2. Press the REC TIME key.



3. Press the corresponding Zone key (1–8), Power(0), or Sound(9).



The 1800 will say “Enter minutes.”

4. Using the number keys, enter minutes. Then press ENTER.



The 1800 will say “Enter seconds.”

5. Using the number keys, enter seconds. Then press ENTER.



The 1800 will say “OK.”

To play back the Alarm Recognition Time:

1. Press the WHAT IS key.



2. Press the REC TIME key.



3. Press the corresponding Zone key (1–8), Power(0), or Sound (9).



The 1800 will recite the programmed recognition time for that Zone.

ALARM LIMITS

The Alarm Limits determine the level at which a temperature or 4–20mA Zone has reached the alarm threshold. The input value must not exceed the Alarm Limit to trip an alarm. Each Zone has a programmable Low and High Alarm Limit. The default settings are Low Limit=0 and High Limit=100. The range of programming for 2.8K thermistors is -109° to 115°F (-85° to 57°C). The range of programming for 10K thermistors is -87° to 168°F (-66° to 76°C). For zones configured as 4–20mA the range of programming is -10,000 to 10,000. To make a value negative, precede the value with the [RINGS/TAD/*] key.

NOTE: Only Zones configured as temperature or 4–20mA can have Alarm Limits programmed.

To program the Low Alarm Limit:

1. Press the SET key.



2. Press the LOW LIMIT key.



3. Press the corresponding Zone key (1–8), 1800 will say “Enter number.”



4. Using the number keys, enter a value. Then press ENTER.



To program the High Alarm Limit:

1) Press the SET key.



2) Press the HIGH LIMIT key.



3) Press the corresponding Zone key (1-8), 1800 will say “Enter number.”



4. Using the number keys, enter a value. Then press ENTER.



To Play back the Low Alarm Limit:

1. Press the WHAT IS key.



2. Press the LOW LIMIT key.



3. Press the corresponding Zone key (1-8), 1800 will say the programmed value.

To Play Back the High Alarm Limit:

1. Press the WHAT IS key.



2. Press the HIGH LIMIT key.



3. Press the corresponding Zone key (1-8), 1800 will say the programmed value.



ZONE CALIBRATION

Due to tolerance variations or other factors, you may need to program an offset to calibrate the sensor Zones. The offset can range from -15 to +15 for Zones configured as temperature, and -100 to +100 for Zones configured as 4–20mA. Setting a positive number will add that number to the Zone reading. Setting a negative number will subtract the programmed value from the Zone reading. For instance, if a temperature sensor consistently read two degrees high, you could use the calibration feature to adjust that temperature down two degrees. To make a value negative, precede the value with the [RINGS/TAD/*] Key.

To calibrate a Zone:

1. Press the SET key.



2. Press the CALIBRATE key.



1800 will say “Enter number.”

3. Press the corresponding Zone key (1–8).



1800 will say “Enter number.”

4. Enter the number. Then press ENTER.



The 1800 will say “OK.”

To play back the present calibration:

1. Press the WHAT IS key.



2. Press the CALIBRATE key.



3. Press the corresponding Zone key (1–8).

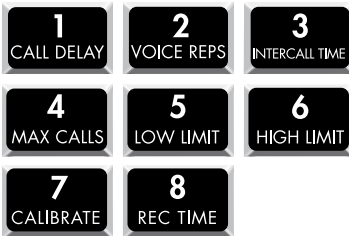

The 1800 will recite the programmed calibration.

SOUND LEVEL CALIBRATION

This feature allows you to program the level of sound that will cause the 1800 to respond to an alarm and dial out. It may be useful to desensitize the 1800 to sound if it is installed in an area with a relatively high noise level, or where a loud noise occurs frequently but is not associated with an alarm. In some applications, it may be desirable to increase sound sensitivity to low Sound Levels. The sensitivity setting (calibration) for sound alarm monitoring ranges from 1 to 255. A value of 1 makes the microphone the MOST sensitive to changes in sound. The value 255 makes the microphone the LEAST sensitive to sound. The default value is 32.

To calibrate the Sound Level:

1. Press the SET key.



2. Press the CALIBRATE key.



3. Press the SOUND key.



The 1800 responds: “Enter number.”

4. Using the number keys, enter a value for sound calibration and press ENTER



1800 will say “OK.”

To play back the Sound Level calibration:

1. Press the WHAT IS key.



2. Press the CALIBRATE key.



3. Press the SOUND key.



The 1800 will recite the programmed sound sensitivity level.

DESIGNATING A ZONE AS UNUSED

This feature allows you to mark selected Zones as unused, which will prohibit them from going into alarm and will also leave them out of the status report.

To designate a Zone as unused:

1. Press the SENSOR ON/OFF key.



2. Press the SET key.



The 1800 will say “Enter Number.”

3. Press the corresponding number of the Zone you wish to mark as unused.



The 1800 will respond by saying “Off.” Repeat the key sequence to place the Zone back in use.

EXIT DELAY

The Exit Delay feature is useful when you are using your 1800 for security monitoring. This feature allows you to exit a building without tripping a security alarm. When tripping an alarm is unavoidable, yet a true alert condition has not actually occurred, the alarm response—including dial-out—can be temporarily suppressed.

The 1800 is able to suppress and then reset its dial-out function automatically through use of the Status Report. This is especially convenient when an alert condition is created upon exiting a monitored door, and there is no way to cancel from the local keypad.

Example: You are planning to exit through a monitored door. Prior to exiting, you initiate a Status Report recitation at the 1800 keypad by pressing [WHAT IS], followed by [STATUS], (key sequence shown below). This allows you approximately 60 seconds to exit without activating the 1800's programmed response to an alarm. At the conclusion of the status report, normal alarm response is reactivated.

To use exit delay, initiate the Status Report.

1. Press WHAT IS.



2. Press STATUS.



The 1800 recites the full Status Report; during this time, you are able to exit the monitored area without tripping an alarm.

TEMPERATURE-ONLY STATUS REPORT

You can receive a limited status report that only includes inputs configured as temperature. This can be useful when you don't care to listen to the entire status report.

To initiate a Temperature-only Status Report:

1. Press the What IS key



2. Press the Test key.



CHAPTER 5: COMMUNICATION PROGRAMMING

This chapter explains the keyboard commands for programming the communications functions of the 1800. This includes programming, interrogating and/or resetting of:

- Date and Time
- Voice messages
- ID Number
- Dial-out phone numbers
- Special dialing
- Tone or pulse dialing
- Rings until answer
- Call delay time
- Intercall time
- Call Progress
- Voice repetitions
- Maximum number of calls
- Telephone Answering Device compatibility
- Listen-in time
- Keypad lock
- Local voice mute

DATE and TIME

The 1800 has an internal clock/calendar that is used to time-stamp events and maintain alarm history. To program the date and time:

1. Press SET, followed by the DATE/TIME key.



2. The unit will say “Enter date.” Enter the date in month/day/year (mm/dd/yy) format using two digits for each. For example, if the date was January 7, 2006 you would enter 010706, then press ENTER.



3. Next, the unit will say “Enter time.” Enter the time in 24-hour format (e.g. 3:00PM = 15:00) using hours/minutes (hh/mm) format. For example, if the time was 1:30PM you would enter 1330, then press ENTER.



4. To check the date and time press WHAT IS, followed by DATE/TIME. The unit will announce the date and time.



NOTE: The internal clock is powered by an onboard lithium battery which should provide 10 years of service life.

To program only the Date or only the Time, you can simply press the ENTER key when prompted and the unit will keep its current value. For example, to program a new TIME but keep the current DATE, press [ENTER] when prompted for the Date. The unit will keep the current setting and then prompt you to enter the new Time.

VOICE MESSAGES

The 1800's digital speech recording feature allows you to record custom messages for each of the eight Zones and an ID Message. This means that when 1800 calls you during an alarm, you will hear a personalized Voice Message telling you exactly what alarm condition exists. You can record a separate message for each of the eight Zones. The message can run a maximum of 3.75 seconds. The ID Message can be a maximum of six seconds.

The ID Message is used to identify the unit. This could be a particular building name, its location (address or city), or some other identifier.

To program the ID Message:

1. Locate the condenser mic.



2. Press the SET key.



3. Press the MESSAGE key.



4. Press ID key (number 0 key).



5. When the unit beeps, begin speaking your message into the microphone. The microphone is located next to the power switch on the front panel. The unit will say "OK," when the recording time has elapsed; then it will play back your recorded message.

To play back the ID Message:

1. Press the WHAT IS key.



2. Press the MESSAGE key.



3. Press the ID key (number 0 key).



4. The 1800 will play back your recorded message.

The Zone Messages are used to identify the device or condition being monitored such as temperature, humidity, equipment alarms, security alarms, etc.

To program the Voice Message for Zone 1:

1. Locate the condenser mic.



Phone In Use 

System On 

SENSAPHONE®
1800

REMOTE MONITORING SYSTEM



• ← Mic

2. Press the SET key.



3. Press the MESSAGE key.



4. Press number 1 key (substitute other Zone numbers to record their respective messages).



5. When the unit beeps begin speaking your message into the microphone. The microphone is located next to the power switch on the front panel. The unit will say “OK,” when the recording time has elapsed; then it will play back your recorded message.

To play back the message for Zone 1:

1. Press the WHAT IS key.



2. Press the MESSAGE key.



3. Press the number 1 key (substitute other Zone numbers to hear their respective messages).



The 1800 will play back your recorded message.

ID NUMBER

The ID Number is the identification number of the 1800. This number is typically the telephone number where the unit is installed, or it may be designated using any number that best suits your application. The purpose of the ID Number is to immediately provide the source of any alarm, especially when using multiple 1800 units in a complex monitoring system. The ID number is announced during voice alarm messages and displayed on pagers. The ID Number can be up to 16 digits long.

When the 1800 is called from a remote location, it always begins its message with the identification number: “Hello, this is (ID Number).”

To program the ID Number:

1. Press the SET key.



2. Press the ID key (number 0 key).



3. The unit will say “Enter number.” Using the number keys, enter the unit’s phone number, then press ENTER.



If the number was accepted, the 1800 will say “OK.”

To play back the ID Number:

1. Press the WHAT IS key.



2. Press the ID key (number 0 key).



3. The 1800 will recite the ID Number.

ALARM DIAL-OUT TELEPHONE NUMBERS

The Sensaphone 1800 will dial up to eight 48-digit phone numbers to report alarm conditions. These are the numbers that will be called during an alarm dial-out. The unit can deliver an alarm message via voice telephone call, numeric page, or alphanumeric page. Most wireless phones can also receive the alarm message as text when programmed using the alphanumeric page format. The telephone numbers are dialed sequentially 1 through 8. Therefore, program the first number you want called as Phone #1, the second one as Phone #2, and so on. A pause, pound or asterisk can be added to the phone number to access different phone and beeper systems (see special dialing options). Once the alarm is acknowledged, all dial-out stops.

Voice Dialout

When 1800 calls in Voice mode it will announce the ID Message and the alarm message. Afterward it will ask for the acknowledgement code. If a correct code is entered, the unit will stop dialout. If the wrong code is entered it will hang up and continue dialing the next number.

To program a VOICE dial-out telephone number:

1. Press the SET key.



2. Press the PHONE NUMBER key.



3. Select which Phone number to program. Press any unassigned number key (keys 1–8) to represent the new telephone number entry. 1800 will respond: “Enter number.”



4. Enter the phone number using the number keys, and then press ENTER.



1800 will say “OK.”

To play back a programmed dial-out telephone number:

1. Press the WHAT IS key.



2. Press the PHONE NUMBER key.



3. Select an assigned Phone number (keys 1–8)



The 1800 will recite the type of call (voice, pager, alphanumeric pager) and the number programmed. If there is no number programmed, 1800 will say “No number.”

Numeric Pager Dialout

When programming the 1800 to dial a Numeric pager there are two methods that can be used: **Automatic** mode and **Manual** mode.

The only difference is that in Automatic mode the 1800 will automatically try to sense when the call has been answered and then send the ID Number and alarms. In some instances, the automatic answer detection and timing from the 1800 is incompatible with the paging service, and the Manual mode must be used.

NOTE: If your phone system requires you to dial a ‘9’ followed by a pause to get an outside line, you *must* use **Manual** mode and insert the pauses at the end of the number.

When the 1800 calls your Numeric Pager it will leave the programmed ID Number along with the Zone number that is in alarm. To acknowledge the alarm you will have to call the unit back and enter an acknowledgement code, otherwise the unit will continue dialing the remaining numbers.

To program a NUMERIC PAGER using AUTOMATIC Mode:

1. Press the SET key



2. Press the PHONE NUMBER key.



3. Select which Phone number to program. Press any unassigned number key (keys 1–8) to represent the new telephone number entry. 1800 will respond: “Enter number.”

4. Press CODE 3 (This tells 1800 this is a Numeric pager call).



5. Enter the pager telephone number using the number keys. Then press ENTER.



The 1800 will say “OK.”

To program a NUMERIC PAGER using the MANUAL Mode:

1. Press the SET key.



2. Press the PHONE NUMBER key.



3. Select which Phone number to program. Press any unassigned number key (keys 1–8) to represent the new telephone number entry. 1800 will respond: “Enter number.”



4. Press CODE 3 (This tells 1800 this is a Numeric pager call).



5. Enter the pager telephone number using the number keys.



6. Press CODE 1 twice.



NOTE: Depending on your pager service, you may need to insert a longer or shorter delay (additional pauses). Two pauses is the recommended starting point. Use the Dial-out Test Mode to help determine the proper number of pauses for your pager service. When it is programmed properly, you will hear the 1800 dial your pager service, then wait (based on the number of pauses) until the call has been answered, and then send another series of Touch-Tones and hang up.

7. Press the ENTER key.



To play back a NUMERIC PAGER number:

1. Press WHAT IS



2. Press the PHONE NUMBER key



3. Select the programmed Phone Number from the number keys (keys 1–8). 1800 will recite the type of call, “pager,” followed by the pager number assigned to that key.

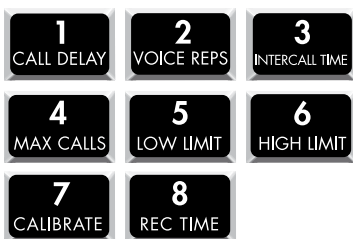

Alphanumeric Pager Dialout

When the 1800 sends a text message to your alphanumeric pager (or wireless phone) it must connect with your service provider’s paging terminal. This is a telephone number that is answered by a modem.

Your service provider’s paging terminal must support TAP protocol. This is the standard protocol used by most major service providers. You will need to know this telephone number and your pager ID Number to program this type of call into the 1800. ***If you don’t know the paging terminal number or your pager ID Number, contact your service provider (or visit their web page).***

When sending text messages to your wireless telephone, the pager ID is typically the telephone number of your phone. Many wireless phone providers have toll-free national numbers for their paging terminals. The list below is provided for your convenience.

TAP Protocol Paging Terminal Phone Numbers

- Cingular Wireless: 800-469-5351
- MCI: 800-759-6366
- Mobil Comm: 800-946-4644
- NEXTEL National: 800-201-2501
- Sprint: 888-656-1727
- Verizon Wireless: 866-823-0501

To program an ALPHANUMERIC PAGER dial-out telephone number:

1. Press the SET key



2. Press the PHONE NUMBER key



3. Press any unassigned number key (keys 1–8) to represent the new telephone number entry. 1800 will respond: “Enter number.”



4. Press CODE 4 (tells 1800 this is an Alpha Numeric pager call). 1800 will say “Alpha Pager.”



5. Enter the telephone number of your paging terminal using the number keys.



6. Press CODE 5 (this tells the 1800 that the next digits will be the pager ID number).



1800 will say “Alpha ID.”

7. Using the number keys, enter the pager ID Number and then press ENTER.



The 1800 will say “OK.”

To play back an ALPHANUMERIC PAGER number:

1. Press WHAT IS.



2. Press the PHONE NUMBER key.



3. Select the programmed Phone Number from the number keys (keys 1–8). 1800 will recite the the type of call, “Alpha Pager,” followed by the paging terminal number and the Alpha ID Number.



To delete a dial-out telephone number:

1. Press the SET key.



2. Press the PHONE NUMBER key.



3. Select the Phone number (1–8) to erase.



The 1800 will say “Enter number.”

4. Press the ENTER key. 1800 will say “OK.”



SPECIAL DIALING OPTIONS

The 1800 has provisions for special dialing requirements. These including dialing a * or #, inserting a two-second pause, or forcing the system to wait for the called party to answer. These options are typically used when: (a) the unit is connected to a PBX and must dial a '9' or extension to reach an outside line; (b) when dialing a business and stepping through menus to reach a specific extension; or (c) when a pager service is answered by a voice menu. The special dialing commands can be inserted as part of the dialout telephone number. Valid commands are listed below:

- A # tone can be dialed by inserting the Table Range/# key in the telephone number.



- The * tone can be dialed by inserting the Rings/Tad/* key in the telephone number.



- A two-second pause can be inserted in the dialout telephone number by pressing CODE 1.

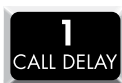

- The 1800 can be instructed to wait for the call to be answered before dialing additional digits. This is useful if you need to call a company's main number and then dial additional digits to go to a specific extension (Example: 888-555-1200—wait for answer—227). Press CODE 2 to make the unit wait for an answer.



Blind Dialing

The 1800 normally checks for a dial tone before dialing. However, if your telephone system does not produce a dial tone, you can make the 1800 dial blindly (i.e., without dial tone). To do this, make the first digit of each telephone number a pause (CODE 1). When the 1800 sees this as the first digit, it will not check for a dial tone, but dial the number regardless.

Special Dialing Codes for the 1800 are:

- Code 1: two second pause
- Code 2: Wait for answer
- Code 3: Numeric pager type
- Code 4: Alphanumeric pager type
- Code 5: Alphanumeric pager ID Number
- Code 6: Change to Touch-Tone dialing

DIAL-OUT TEST MODE

The 1800 allows you to test your telephone programming by simulating an alarm dialout to any programmed telephone number. This can be a valuable tool for insuring that your programming is correct and also for troubleshooting dialing problems. In this mode all signals on the telephone line are audible through the local speaker.

To test a dialout phone number:

1. Press the SET key.



2. Press the TEST key.



The 1800 will say “Enter Number.”

3. Press a number key (1–8) corresponding to the phone number entry you wish to test, and press ENTER.

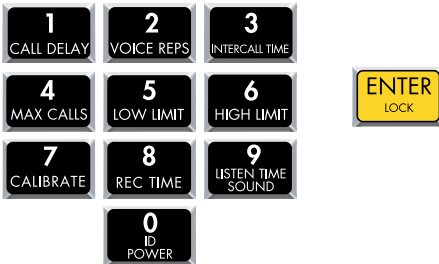

The 1800 will dial the number and send a test message.

ALARM ACKNOWLEDGMENT CODES

When the 1800 detects an alarm, it starts dialing each telephone number until it receives acknowledgment. An alarm can be acknowledged either by pressing the ALARM CANCEL button on the keypad and entering an *Acknowledgment Code*, or by entering the *Acknowledgment Code* over the telephone using touch tones. An Acknowledgment Code is made up of five digits: the user's entry number (1–8) plus a four-digit code. Up to eight different Acknowledgment Codes may be programmed into the unit to identify individual users in the Alarm History Log. When the unit makes a telephone call in *Voice* mode it will prompt the user to enter an Acknowledgment Code. If this is entered correctly, the 1800 will say "Alarm Acknowledged." When an alarm message is sent to a *pager*, the person who receives the page will have to call the unit back to acknowledge the alarm. When acknowledging an alarm, the user must first press their entry number (1–8), and then their programmed 4-digit Acknowledgment Code. *Acknowledgment Code 1* defaults to 1234, so to acknowledge an alarm the user would have to enter 11234. All other Codes (2–8) are not programmed by default.

To Program an Acknowledgment Code:

1. Press SET.



2. Press CODE.



3. Press a telephone number entry (1–8).



The 1800 will say “Enter code.”

4. Enter a 4-digit acknowledgment code.

The 1800 will say “OK.”

To play back an Acknowledgment Code:

1. Press WHAT IS.



2. Press CODE.



3. Press a telephone number entry 1–8.

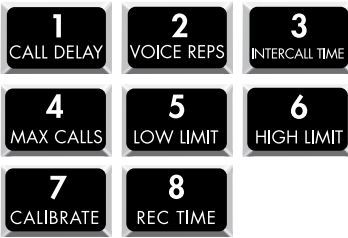

The 1800 will recite the Acknowledgment Code for the selected telephone number entry.

ALARM HISTORY

The 1800 will retain historical information on the last 10 alarms. The information retained includes: Zone number, the time/date that the alarm occurred, and the User number that acknowledged the alarm.

To hear the Alarm History:

1. Press the WHAT IS key.



2. Press the HISTORY key.

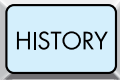

The unit will recite the history for the last 10 alarms. A sample report is shown below:

“Zone 1 (custom message) alarm high at 3:31PM 4/8/2003
acknowledged by number 4”

“Zone 8 (custom message) alarm low at 2:35AM 3/27/2003
acknowledged by number 1”

Deleting the Alarm History

The Alarm History can be deleted by pressing SET, then HISTORY.

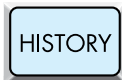

TONE OR PULSE DIALING

The 1800 can dial out in pulse or touch-tones. All numbers will be called using the chosen dialing method. The default is TONE.

To program as either Tone or Pulse:

1. Press the SENSOR ON/OFF key.



2. Press the PHONE NUMBER(T/P) key.



The unit will say “On” to indicate that Tone dialing is enabled, it will say “Off” when tone dialing is disabled (i.e., when pulse dialing is enabled).

RINGS UNTIL ANSWER

The Rings Until Answer is the number of rings that must occur before 1800 answers the phone. This value can be from 1 to 15. The default value is 4.

To program Rings Until Answer:

1. Press the SET key



2. Press the RINGS key.



1800 will say “Enter number.”

3. Using the number keys, enter a value and press ENTER.



The 1800 will say “OK.”

To play back the Rings Until Answer:

1. Press the WHAT IS key



2. Press the RINGS key.



The 1800 will recite the programmed value.

CALL DELAY TIME

The call delay time is the length of time the 1800 will announce an alarm before it starts the dial-out sequence. This only applies to the first call. To set delay time *between* calls, see INTERCALL TIME. The default call delay time is 30 seconds. It can be programmed from 0 to 60 minutes. The purpose of Call Delay is to allow time for personnel at the 1800's installation site to respond to and cancel an alarm before dial-out begins. During this time, the unit will audibly repeat its "alarm" message and the front panel alarm LED will blink.

To program call delay time:

1. Press the SET key.



2. Press the CALL DELAY key.

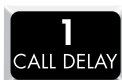

1800 will say "Enter minutes."

3. Enter the number of minutes using the number keys. Then press ENTER.



The 1800 will say "Enter Seconds."

- Using the number keys, enter the number of seconds, and then press ENTER.



The 1800 will say “OK.”

To play back the call delay time:

- Press the WHAT IS key.



- Press the CALL DELAY key.



The 1800 will recite the programmed time.

INTERCALL TIME

The Intercall Time is the programmable period of time the 1800 waits between making alarm phone calls. Intercall Time is activated ***only after alarm dial-out to the first telephone number fails to be acknowledged.*** This period can be programmed from 10 seconds to 60 minutes. The default Intercall Time is 30 seconds.

TIP: When the 1800 is programmed to make calls to pagers, make sure the intercall delay time is long enough to give the person carrying the pager some time to get to a phone to call the unit back.

If an incoming telephone call is received by 1800 during the Intercall Time (in between dialing of subsequent telephone numbers to report an alarm), it will answer the incoming call and immediately report any existing alarms. The manner in which the incoming call is answered depends upon whether or not TAD is enabled or disabled:

If TAD is disabled (default), Rings Until Answer will be the programmed number of rings.

If TAD (Telephone Answering Device) is enabled, Rings Until Answer will be 1.

To program intercall time:

1. Press the SET key.



2. Press the INTERCALL TIME key.



The 1800 will say “Enter minutes.”

- Using the number keys, enter the number of minutes, and then press ENTER.



1800 will say “Enter seconds.”

- Using the number keys, enter the number of seconds, and press ENTER.



The 1800 will say “OK.”

To play back the Intercall Time:

- Press the WHAT IS key



- Press the INTERCALL TIME key



The 1800 will recite the programmed time.

CALL PROGRESS

The 1800 monitors call progress when it dials out for an alarm. If 1800 encounters a busy signal or receives no answer after eight rings, the unit hangs up, waits the programmed intercall time and then dials the next phone number. When dialing some beeper/pager services, the line may be answered before receiving a ringback. This may interfere with the call progress detection and result in a failed call to certain phone systems or beeper/pager services. If this occurs, disable call progress detection.

To disable call progress detection:

1. Press the SENSOR ON/OFF key.

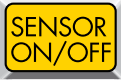

2. Press the STATUS/CONFIG key.



1800 will respond “Off” to indicate that call progress has been turned off.

3. Repeat key sequence to change.

VOICE REPETITIONS

The voice repetitions is the number of times the 1800 will recite the alarm message per phone call when it dials out. This can be programmed from 1 to 10 repetitions. The default value is 3 repetitions.

To program the voice repetitions:

1. Press the SET key.



2. Press the VOICE REPS key.



The 1800 will say, “Enter number.”

3. Using the number keys, enter a value and then press ENTER.



The 1800 will say “OK.”

To play back the number of voice repetitions:

1. Press the WHAT IS key.



2. Press the VOICE REPS key.



The 1800 will repeat the number programmed.

MAX CALLS

The 1800 has the ability to acknowledge itself by using the Max Calls function. The unit keeps a count of the number of phone calls it makes for a particular alarm. Once the number of calls made reaches Max Calls, the 1800 will acknowledge the alarm and stop the dialout process. The unit indicates it has reached max calls by saying “alarm acknowledged by (ID Number).” The max calls can be programmed from 0 to 255. The default is 100.

NOTE: If only one Phone Number is programmed, 1800 will dial a maximum of 15 times, regardless of the programmed value of max calls, as required by FCC rules.

To program Max Calls:

1. Press the SET key.



2. Press the MAX CALLS key.



1800 will say “Enter number.”

3. Using the number keys, enter a value, then press ENTER.



The 1800 will say “OK.”

To play back Max Calls:

1. Press the WHAT IS key.



2. Press the MAX CALLS key.



The 1800 will recite the value of max calls.

TELEPHONE ANSWERING DEVICE (TAD) COMPATIBILITY

The 1800 can be used on the same telephone line as a telephone answering device, such as an answering machine, fax machine, or modem. This feature allows you to call in to 1800 and bypass the answering device.

To use TAD:

1. Program 1800's Rings Until Answer to a greater number than the rings until answer for your answering device. For example, 1800 RINGS = 5, device rings = 3.
2. Press the SENSOR ON/OFF key.



3. Press the TAD key.



The 1800 will say "On." (If 1800 says "Off" repeat steps 2 and 3.)

4. Once TAD is on, allow the phone to ring once when you call the unit and then hang up. 1800 recognizes that a call was made and activates a 30 second internal timer. This allows you 30 seconds to call the 1800 back.
5. Call back within 30 seconds. 1800 will override the answering device on this incoming call and answer the phone on the first ring. 1800 resets the TAD timer after one incoming call is received. If you want to call the unit again, you must repeat steps 4 and 5.

LISTEN-IN TIME

The Listen-In Time is the amount of time you can listen to sounds at the unit's location during a status call-in. An external microphone (optional) is required to listen in to on-site sounds. The programmable range is 0 to 255 seconds. The default setting is 0 seconds (disabled).

To program the Listen-In Time:

1. Press the SET key.



2. Press the LISTEN TIME key.



1800 will say "Enter seconds."

3. Using the number keys, enter the seconds, then press ENTER.



The 1800 will say "OK."

To play back the Listen-in Time:

1. Press the WHAT IS key.



2. Press the LISTEN TIME key.



The 1800 will recite the time programmed.

LOCKING THE KEYPAD

The keypad can be locked to prevent unauthorized access to the 1800's programming. This will only prevent programming from being changed. You may, however, play back programming parameters and listen to a status report without unlocking the keypad. To edit programming parameters or record messages, you must unlock the keyboard by entering the four-digit lock/unlock code.

For call-in access, you may freely listen to a status report but the lock/unlock code must be entered via touch-tone phone to obtain programming access if the keypad is in the "locked" mode. If you enter the correct code, you will gain access to 1800 to use the phone commands. If you enter the incorrect code, 1800 will hang up. You cannot program or change the lock code remotely.

For an explanation of how to use the lock code during a call-in, see Chapter Eight.

To Lock the keypad:

1. Press the SET key.



2. Press the LOCK key.



The 1800 will say "Enter security code."

3. Using the number keys, enter 4 digits, and press ENTER.



The 1800 will say "OK."

To Unlock the keypad:

1. Press the WHAT IS key.



2. Press the LOCK key.



1800 will say “Enter security code.”

3. Using the number keys, enter your 4-digit code and press ENTER. (If you enter the incorrect code, 1800 will say “error 2.”)



If the correct code was entered, the 1800 will say “OK.”

NOTE: You may not interrogate the security code. The WHAT IS key is used to unlock the keypad when the correct code is entered.

SPEAKER MUTE

When the 1800 dials out with an alarm, it recites the alarm message over the phone and at the monitor site. The Speaker Mute command allows you to silence the 1800 at the monitor site.

To Mute the speaker:

1. Press the SENSOR ON/OFF key.



2. Press the MUTE key.



The 1800 will say “On” to indicate that the speaker mute is on. It will say “Off” to indicate when the speaker mute is off.

3. Repeat key sequence to change.

CALLBACK ACKNOWLEDGMENT

This is an optional feature that can be enabled using the keypad (*default=disabled*). It allows an alarm to be acknowledged simply by calling the unit and letting the line ring 10 times. When this feature is enabled it will temporarily make the Rings Until Answer set to 10 when an unacknowledged alarm exists. If you receive a call via Voice or Pager and are unable to send touch-tones, then you can call the unit back, let the line ring 10 times, and the unit will answer and say “Alarm Acknowledged.”

NOTE: If TAD is also enabled, then the 1800 will answer on 1 ring and acknowledge the alarm.

To Enable the Callback Acknowledgment Feature:

1. Press SENSOR ON/OFF.



2. Press CODE.



The 1800 will say “On” to indicate that Callback Acknowledgment is enabled. Repeat the key sequence to disable.

CHAPTER 6: CONTROLLING THE OUTPUT

The 1800 includes a relay output that can be used to control a light, siren, or other device. The output is a Form-C Normally Open/ Normally Closed mechanical relay and is rated for 120VAC 2A. A sample wiring diagram is shown below:

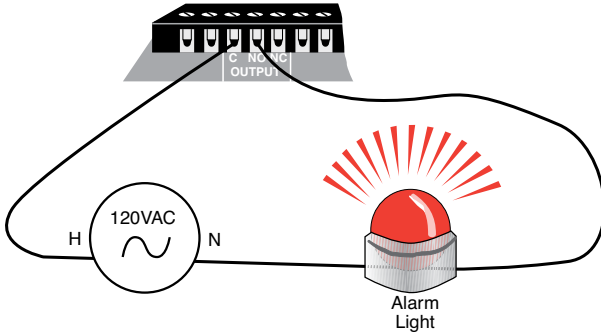

Figure 1: Relay output connected to alarm

The output can be programmed to operate in one of 10 automatic modes or it can operate in manual mode. The 10 *automatic* modes allow the output to automatically turn on and off based on individual alarms or any alarm. In *manual* mode the output is controlled via keypad command or remotely via touch-tone phone (See Chapter 8). A description of each mode is shown below:

AUTOMATIC MODES

Mode 1: Output on when zone 1 goes into alarm. Off when alarm is acknowledged.

Mode 2: Output on when zone 2 goes into alarm. Off when alarm is acknowledged.

Mode 3: Output on when zone 3 goes into alarm. Off when alarm is acknowledged.

Mode 4: Output on when zone 4 goes into alarm. Off when alarm is acknowledged.

Mode 5: Output on when zone 5 goes into alarm. Off when alarm is acknowledged.

Mode 6: Output on when zone 6 goes into alarm. Off when alarm is acknowledged.

Mode 7: Output on when zone 7 goes into alarm. Off when alarm is acknowledged.

Mode 8: Output on when zone 8 goes into alarm. Off when alarm is acknowledged.

Mode 9: Output on when a Sound alarm occurs. Off when alarm is acknowledged.

Mode 0: Output on when a Power alarm occurs. Off when alarm is acknowledged.

Mode 10: Output on when any alarm occurs. Off when all alarms are acknowledged.

MANUAL MODE

Mode 11: Output controlled manually via keypad command or touch-tone telephone.

When programmed for Manual mode, the command to switch the output is:

SENSOR ON/OFF + OUTPUT.



The 1800 will respond “ON” or “OFF” to indicate the state of the output.

Note: If the 1800 says nothing, the output is not programmed for manual mode.

To program the Output Mode:

1. Press the SET key.



2. Press the OUTPUT key.



The 1800 will say “Enter Number.”

- Using the number keys, enter a value for the output mode.



- Press the ENTER key.



The 1800 will say “OK” and recite a description of the mode selected, such as “Automatic on Zone 1” or “Manual.” Note that when *Mode 10* is selected, the 1800 will simply say “Automatic on Alarm,” meaning that the output will automatically turn on when any alarm occurs.

To play back the programmed Output Mode:

- Press WHAT IS.



- Press OUTPUT.



The 1800 will recite the programmed output mode.

CHAPTER 7: OPERATION

After installation and programming have been completed, the 1800 is fully operational. This chapter explains how the 1800 operates.

ALARM DIALOUT AND ACKNOWLEDGMENT

There are three stages to a complete alarm event: 1) Alarm Recognition, 2) Alarm Notification, 3) Acknowledgment. Note that not all alert conditions will go through each stage. For example, some may not meet the recognition time.

Alarm Recognition

1. The 1800 monitors eight zones plus sound level and power failure. When the status of a zone changes or exceeds user-programmed limits, it causes an alert condition.
2. If the alert condition lasts long enough to meet its programmed recognition time, the alert condition becomes an alarm and the 1800 begins the alarm notification sequence.

Alarm Notification

The 1800 can make three types of phone calls: Voice, Numeric Pager, and Alphanumeric Pager.

Dialout Note: Call Progress

The 1800 monitors call progress when dialing out. If the 1800 dials out and encounters a busy signal or no answer within 30 seconds, the unit hangs up, waits the programmed intercall delay time, and then dials the next phone number.

NOTE: Dial-tone and call-progress detection may optionally be disabled.

Alarm Dialout—Voice

When dialing out to a destination programmed as “voice,” the 1800 waits for the phone to be answered, then recites its user-recorded identification message, then the message identifying the zone or zones that have gone into alarm.

Below is an example of what the 1800 might say during a typical “voice” dialout:

“Hello, this is 555-2278, ‘Acme Warehouse at 3rd and Chestnut Streets,’ Zone One, ‘Temperature in refrigerator one,’ alarm exists, temperature too high, it is now 45 degrees F.”

“Hello, this is 555-2278, ‘Acme Warehouse at 3rd and Chestnut Streets,’ Zone One, ‘Temperature in refrigerator one,’ alarm exists, temperature too high, it is now 45 degrees F.”

“Hello, this is 555-2278, ‘Acme Warehouse at 3rd and Chestnut Streets,’ Zone One, ‘Temperature in refrigerator one,’ alarm exists, temperature too high, it is now 45 degrees F.”

“Enter acknowledgment code.”

In this example, the number of Voice Message Repetitions was set to three.

NOTE: If the call reaches an answering machine, the message will be recorded, but the 1800 will be talking over your outgoing message, so you will probably lose part of the first alarm message repetition.

Alarm Dialout—Pager

When dialing out to a destination programmed as “Numeric Pager,” the 1800 leaves its programmed ID number on the display of a numeric pager along with the zone number(s) in alarm.

IMPORTANT: When dialing out to a phone number programmed as “Numeric Pager,” the 1800 DOES NOT speak a voice message. It calls the pager company or service, enters the number to be displayed on the beeper, then hangs up.

Alarm Dialout—Alphanumeric Pager

When dialing out to a destination programmed as “Alphanumeric Pager,” the 1800 leaves a text message up to 160 characters long on the display of an alphanumeric pager or wireless phone.

IMPORTANT: When dialing out to a phone number programmed as “Alphanumeric Pager,” the 1800 DOES NOT speak a voice message. It calls the pager company or service, transmits the information to be displayed on the pager, then hangs up.

ALARM ACKNOWLEDGMENT

Alarm Acknowledgment—Voice Dialout

Repeated below is the same example of what the 1800 might say during a typical “voice” dialout:

“Hello, this is 555-2278, ‘Acme Warehouse at 3rd and Chestnut Streets,’ Zone One, ‘Temperature in refrigerator one,’ alarm exists, temperature too high, it is now 45 degrees F.”

“Hello, this is 555-2278, ‘Acme Warehouse at 3rd and Chestnut Streets,’ Zone One, ‘Temperature in refrigerator one,’ alarm exists, temperature too high, it is now 45 degrees F.”

“Hello, this is 555-2278, ‘Acme Warehouse at 3rd and Chestnut Streets,’ Zone One, ‘Temperature in refrigerator one,’ alarm exists, temperature too high, it is now 45 degrees F.”

“Enter acknowledgment code.”

The 1800 will now wait 5 seconds for a Touch-Tone acknowledgment code to be entered. After the last digit of the acknowledgment code has been received, the 1800 will respond by saying: “Alarm Acknowledged.” The alarm has been acknowledged and the unit will hang up. Once the alarm has been acknowledged, the dialout process stops.

If a Touch-Tone acknowledgment code is not received, the 1800 will offer you a second chance to enter it, responding with: “beep,” “error,” “Enter acknowledgment code.” If the acknowledgement code is still not received, then the 1800 will respond by saying: “beep,” “error,” “goodbye.” The alarm has not been acknowledged. The 1800 will hang up and wait for a callback acknowledgment. This waiting period is called the “intercall delay time.” During this time you may call the unit back from a Touch-Tone phone and the unit will give a voice report. Once you receive the complete report, enter the code to acknowledge the alarm. NOTE: An alarm cannot be acknowledged using a pulse (rotary) telephone unless the *Callback Acknowledgment* feature is enabled.

Alarm Acknowledgment—Numeric Pager Dialout

The 1800 will dial out to your pager service and leave a number on the display of your beeper. (*See Programming, Ch. 5*) The unit

will then hang up without speaking a voice message and wait for you to call back and enter an acknowledgment code. This waiting period is called the “intercall delay time.” During this time you may call the unit back from a Touch-Tone phone to receive a report of the alarm condition and acknowledge the alarm by entering the acknowledgment code.

NOTE: An alarm cannot be acknowledged using a pulse (rotary) telephone unless the Callback Acknowledgment feature is enabled.

Below is an example of what the 1800 will say when you call it back to acknowledge a typical alarm:

“Hello, this is 555-2278, ‘Acme Warehouse at 3rd and Chestnut Streets,’ Zone One, ‘Temperature in refrigerator one,’ alarm exists, temperature too high, it is now 45 degrees F.”

“Enter acknowledgment code.”

The 1800 will now wait 10 seconds for a Touch-Tone acknowledgment code to be entered. After the last digit of the acknowledgment code has been received, the 1800 will respond by saying: “Alarm Acknowledged.” The alarm has been acknowledged and the unit will hang up. Once the alarm has been acknowledged, the dialout process stops.

If a Touch-Tone acknowledgment code is not received, the 1800 will offer you a second chance to enter it, responding with: “beep,” “error,” “Enter acknowledgment code.” If an acknowledgement code is still not received, then the 1800 will respond by saying: “beep,” “error,” “goodbye.” The alarm has not been acknowledged. The 1800 will hang up and wait for you to call back and enter the acknowledgment code. This waiting period is called the “intercall delay time.” During this time you may call the unit back from a Touch-Tone phone and the unit will give a voice report. Once you receive the complete report, enter the code to acknowledge the alarm.

NOTE: An alarm cannot be acknowledged using a pulse (rotary) telephone unless the Callback Acknowledgment feature is enabled.

TIP: When the 1800 is programmed to make calls to pagers, make sure the intercall delay time is long enough to give the person carrying the pager some time to get to a phone to call the unit back.

Alarm Acknowledgment—Alphanumeric Pager Dialout

The 1800 will dial out to your alphanumeric pager service and leave a message on the display of your pager. (*See Programming Section, Chapter Five, for dialing to beepers/pagers*). The unit will then hang up without speaking a voice message and wait for you to call back and enter an acknowledgment code. This waiting period is called the “intercall delay time.” During this time you may call the unit back from a Touch-Tone phone to receive a report of the alarm condition and acknowledge the alarm by entering an acknowledgment code.

NOTE: An alarm cannot be acknowledged using a pulse (rotary) telephone unless the Callback Acknowledgment feature is enabled.

Below is an example of what the 1800 will say when you call it back to acknowledge a typical alarm:

“Hello, this is 555-2278, ‘Acme Warehouse at 3rd and Chestnut Streets,’ Zone One, ‘Temperature in refrigerator one,’ alarm exists, temperature too high, it is now 45 degrees F.”

“Enter acknowledgment code.”

The 1800 will now wait 10 seconds for a Touch-Tone acknowledgment code to be entered. After the last digit of the acknowledgment code has been received, the 1800 will respond by saying, “Alarm Acknowledged.” The alarm has been acknowledged and the unit will hang up. Once the alarm has been acknowledged, the dialout process stops.

If a Touch-Tone acknowledgment code is not received, the 1800 will respond by saying: “beep,” “error,” “goodbye.” The alarm has not been acknowledged. The 1800 will hang up and wait for you to call back and enter an acknowledgment code. This waiting period is called the “intercall delay time.” During this time you may call the unit back from a Touch-Tone phone and the unit will give a voice report. Once you receive the complete report, enter

the code to acknowledge the alarm. NOTE: An alarm cannot be acknowledged using a pulse (rotary) telephone unless the *Callback Acknowledgment* feature is enabled.

TIP: When the 1800 is programmed to make calls to alphanumeric pagers, make sure the intercall delay time is long enough to give the person carrying the pager some time to get to a phone to call the unit back.

Alarm Acknowledgment—Automatic (Max Calls)

The 1800 has the ability to acknowledge itself by using the Max Calls function. The unit keeps a count of the number of phone calls it makes for a particular alarm. Once the number of calls made reaches Max Calls, the 1800 will acknowledge the alarm and stop the dialout process.

CALL-IN STATUS

You can also call into the 1800 using a Touch-Tone telephone to obtain a status report. After answering, the 1800 will recite a status report. Immediately following the status report, 1800 allows you to use Touch-Tone commands to enable/disable zones, change limits, control the output, etc. See Remote Commands via Touch-Tone Phone.

Below is an example of a voice status report:

“Hello, this is 555-2278, ‘Facility monitoring system at the Acme Warehouse 3rd and Chestnut Streets’

“Zone one, ‘Temperature in refrigerator one,’ 37 degrees F, OK

“Zone two, ‘Temperature in freezer one,’ 16 degrees F, OK

“Zone three, ‘Water pressure in psi,’ 45, OK

“Zone four, ‘North side ventilation fan speed in rpm,’ 50, OK, acknowledged

“Zone five, ‘South side ventilation fan speed in rpm,’ 01, too low

“Zone six, ‘north side power,’ OK

“Zone seven, ‘south side power,’ acknowledged alarm exists

“Zone eight, ‘Security alarm,’ OK

“Sound is OK”

“Power is ON”

“Battery is OK”

“Good-Bye”

NOTE: If a zone has exceeded its limits or if a NO/NC sensor is in an alarm state but has not yet met its recognition time, the 1800 will beep before reciting the alarm status of that zone. For example, suppose a temperature sensor has a high limit of 45 degrees and a recognition time of 5 minutes. If the current temperature has gone above the limit for 3 minutes and you call in for a status report, the 1800 will say “Zone 1, ‘temperature in refrigerator one,’ 48 degrees, *beep*, too high.”

REMOTE COMMANDS VIA TOUCH-TONE PHONE

You can issue a number of commands to the 1800 remotely using a Touch-Tone telephone. This command mode can be entered at any time during the status report. Simply press a Touch-Tone and the unit will halt the report and respond with “OK.” You are now in Touch-Tone command mode. Commands are available to perform the following functions:

- Enable and disable zones, power monitoring, and sound monitoring
- Recite/Set High and Low alarm limits
- Recite/Set telephone numbers
- Recite/Set the relay output
- Activate the microphone for listen-in
- Recite status report
- Recite alarm history

The commands are put together based on the letters of a touch-tone telephone. See typical telephone keypad layout below.



Figure 1: A telephone keypad

Many of the commands use three letters that represent an abbreviation of the selected command. For example, to Set a High limit on Zone 1 you would press S + H + 1 (or in numeric form 7 + 4 + 1)

The tables below list all of the touch-tone commands that are supported. Commands are listed in both character and numeric formats. The # key is used as an ENTER key. Use the * key to

represent a negative sign or to represent the [CODE] key when programming telephone numbers.

Enable/Disable Zones

The is command will toggle the selected zone between the enabled or disabled state.

<u>Description</u>	<u>Touch-Tone Command</u>
Enable/Disable Zone	* + Z(0) + (zone number)

Set and Recite High & Low Alarm Limits

The following commands are used to set or recite the Low Alarm Limit for any Zone.

<u>Description</u>	<u>Touch-Tone Command</u>
Set Zone Low Limit	S(7)+L(5)+(zone number)+(value)+ #

<u>Description</u>	<u>Touch-Tone Command</u>
What Is Zone Low Limit	W(9)+L(5)+(zone number)+(value)+ #

The following commands are used to set or recite the High Alarm Limit for any Zone.

<u>Description</u>	<u>Touch-Tone Command</u>
Set Zone High Limit	S(7)+H(4)+(zone number)+(value)+ #

<u>Description</u>	<u>Touch-Tone Command</u>
What Is Zone High Limit	W(9)+H(4)+(zone number)+(value)+ #

Set and Recite Telephone Numbers

The following commands will allow you to program and recite dialout telephone numbers.

<u>Description</u>	<u>Touch-Tone Command</u>
Setting a phone number	S(7) + T(8) + (entry 1–8) + (telephone number) + #

<u>Description</u>	<u>Touch-Tone Command</u>
Reciting a phone number	W(9) + T(8) + (entry 1–8)

Control the Relay Output

The following commands will allow you to check the status of the relay output and to toggle the Relay Output On and Off.

<u>Description</u>	<u>Touch-Tone Command</u>
Reciting the Output Status	W(9) + R(7) + O(6)
<u>Description</u>	<u>Touch-Tone Command</u>
Switching the Output	S(7) + R(7) + O(6)

Activate Microphone Listen-in

The following command will allow you to activate the microphone listen-in for the programmed duration.

<u>Description</u>	<u>Touch-Tone Command</u>
Activate Mic Listen-in	M(6) + I(4) + C(2)

Request Status Report

The following command will initiate a status report.

<u>Description</u>	<u>Touch-Tone Command</u>
Recite status report	W(9) + S(7) + R(7)

Request Alarm History

The following command will recite the alarm history.

<u>Description</u>	<u>Touch-Tone Command</u>
Recite alarm history	H(4) + I(4) + S(7)

Hang-up

The following command will make the 1800 hang up the telephone line.

<u>Description</u>	<u>Touch-Tone Command</u>
Hang-up the phone line	B(2) + Y(9) + E(3)

NOTE: If a security code is enabled, the 1800 will prompt you with “Enter security code.” Enter the four-digit keypad security code plus “#” to enter touch-tone command mode. If entered correctly, the 1800 will respond with “OK” and you can proceed to enter the commands. If entered incorrectly, the unit will give you one more chance. If it is incorrect a second time, the unit will say “Error, goodbye” and hang up.

APPENDIX A: Checking Your 1800 for Proper Operation

We recommend that you test your 1800 weekly to be sure it is functioning properly. This will ensure that when a problem arises the 1800 will be ready to alert the appropriate personnel. Phonetics, Inc. also recommends you keep a log of performed tests, and has provided you with a Test Log template at the back of this manual.

There are several tests that can be performed:

1. Call the unit and listen to the Status Report. This will test the unit's ability to answer the phone and speak a message. It will also verify that the inputs are reading properly, the alarm conditions are OK, the electricity is on, the microphone is functioning, and that the batteries are OK.
2. Create a test alarm on each input and allow the unit to contact all programmed telephone numbers. This will make sure that the 1800 is programmed properly. It will also prepare personnel to respond appropriately when they receive a call from the 1800. Listed below are suggestions on how to trip test alarms:
 - Temperature sensors: Heat or cool the sensor.
 - Motion sensors: Have someone walk in front of the sensor.
 - Door/window sensors: open the door/window.
 - Water sensors: Apply a small amount of water beneath the sensor or use a wet towel and touch it to the sensor probes.
 - Humidity sensors: Raise the humidity around the sensor by holding a cup of very hot water beneath the sensor.
 - NO/NC Contacts: Open or close the contact.

Allow the unit to contact all programmed telephone numbers. This will make sure that the 1800 is programmed properly. It will also prepare personnel to respond appropriately when they receive a call from the 1800.

3. Test the batteries by unplugging the AC adapter and making sure that the 1800 continues to function. Press WHAT IS,

then STATUS on the keypad, and listen to the status report. Make sure the report states that “power is off” and “battery is OK.” Keep the AC adapter unplugged so that a Power Failure alarm occurs. Allow the unit to dial all programmed telephone numbers while running on battery backup. Plug in the AC adapter after the unit has finished dialing all of the telephone numbers.

APPENDIX B: Replacing the Back-up Battery

The back-up battery will provide about 4–5 years of service life depending on usage and temperature. After 5 years (or when back-up time is insufficient) the battery should be replaced. Replacement batteries can be ordered from Sensaphone. To replace the battery, follow the instructions below:

1. Turn the power switch off and unplug the power transformer.
2. Loosen the compression wiring connectors and allow 6-10" of cable slack to come into the enclosure. This will make it easier to turn the panel over.
3. Remove the four corner screws securing the keypad/pcb panel and turn the panel over.
4. Remove the connectors from the battery by carefully pulling and wiggling the connectors from the battery tabs.
5. Remove the screws holding the battery bracket and remove the bracket.
6. Dispose/Recycle the old battery following local disposal regulations for lead batteries.
7. Insert the new replacement battery into the slot and replace the bracket. Secure the bracket with the two screws.
8. Attach the battery connector at the end of the BLACK wire to the -(negative) terminal of the new battery.
9. Attach the battery connector at the end of the RED wire to the +(positive) terminal of the new battery.
10. Place the main panel over the four metal stand-offs and reattach the four corner screws.
11. Readjust the cables through the compression connectors and secure the fittings.
12. Plug the power transformer into the outlet and turn on the power switch.

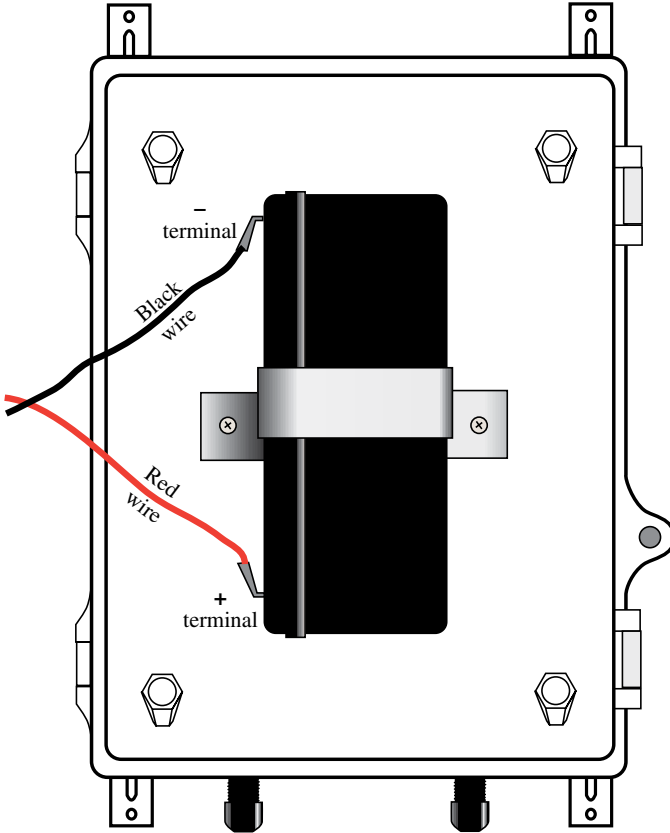

Figure 1: Back-up Battery placement

APPENDIX C: Troubleshooting the 1800

In the event that a problem is encountered, this section will assist you in determining the cause so you can return the unit to its normal monitoring routine with minimal interruption.

Most problems with the 1800 are easy to identify and quickly corrected. See the information under the following general headings:

- Communications/Dialout functions
- Temperature monitoring
- 4–20mA monitoring
- Sound level monitoring
- Other monitoring functions

If you have tried the solutions outlined in this section and are not satisfied with the results, call Sensaphone Technical Support toll-free at 1-877-373-2700. If it is determined that your 1800 requires repair please follow the instructions in Appendix H for returning your unit for service.

COMMUNICATIONS/DIAL-OUT:

Problem 1

The 1800 fails to dial out.

Cause

- a) The telephone number may be incorrectly programmed.
- b) Tone or pulse (the current dialing method) is not compatible with the telephone line on which the 1800 is installed.
- c) Recognition Time is too long. An alert condition does not remain in effect long enough to become a valid alarm.
- d) Max Calls is set to zero.
- e) The 1800 is connected to an incompatible telephone line.

Solution

- Recheck programming steps and use the dial-out test mode to listen to the unit dial. Refer to Chapter 5.
- Switch from the current setting: from tone to pulse, or from pulse to tone. Refer to Chapter 5.
- Reprogram Recognition Time. Set the Recognition Time to the minimum duration required to create a valid alarm. If possible, test the new setting by deliberately creating an alert condition. Refer to Chapter 4.
- Reprogram Max Calls. It is a good idea to set your Max Calls to at least equal the number of dial-out telephone numbers programmed. Refer to Chapter 5.
- The 1800 must be connected to a standard (2-wire analog) telephone line, not a digital extension to a phone system. If the unit will not dial out and the factors previously listed have been ruled out, try connecting the unit to a standard residential telephone line.

Problem 2

The 1800 will not answer the telephone when called for a Status Report or alarm acknowledgment.

Cause

- a) Rings Until Answer is incorrectly programmed.
- b) The 1800 is connected to an incompatible telephone line.

Solution

Recheck programming of Rings Until Answer. Refer to Chapter 5.

Some telephone systems will not allow the telephone to ring beyond 4 rings. If your 1800's Rings Until Answer is set at more than 4 rings, you may not be able to access the unit. Try setting the Rings Until Answer to less than 4 rings. If this does not correct the problem, it may indicate telephone line incompatibility. In this case, try connecting the 1800 to a standard, residential telephone line.

Problem 3

The 1800 will not answer the telephone for Callback Acknowledgment.

Cause

You did not allow the telephone to ring 10 times. Note: If the TAD (telephone answering device) is disabled, the telephone rings ten times before the 1800 answers. If the TAD is enabled, the telephone rings once before the 1800 answers the call.

Solution

When calling the 1800, and the TAD is disabled, allow the telephone to ring 10 times. Refer to Chapter 5.

COMMUNICATIONS/DIAL-OUT *(continued)*

Problem 4

The 1800 recites the alarm message or Status Report over the telephone, but is silent at the installation site.

Cause

The local voice mute feature is in effect.

Solution

Deactivate local voice mute. Refer to the programming steps in Chapter 5.

Problem 5

The 1800 and telephone answering device (sharing the same line) answer incoming calls simultaneously.

Cause

The 1800's number of Rings Until Answer is set to equal the number of rings set for the telephone answering device.

Solution

Change the number of Rings Until Answer for the 1800. Refer to Chapter 5.

TEMPERATURE MONITORING:

Problem 1

Can't program temperature limits; or the unit won't read the temperature sensor.

Cause

The zone isn't configured to read a temperature sensor.

Solution

Press SET and CONFIGURE to program the zone. For 10K thermistor, you must manually configure. See Chapter 4.

Problem 2

The temperature reading is -109° F or -87° F or -85°C or -66° C.

Cause

The temperature sensor has been disconnected or has broken wires.

Solution

Examine the wires to temperature sensor and connect or replace wiring.

Problem 3

Temperature reads 115° F or 168° F or 57° C or 76° C.

Cause

Temperature sensor wires are touching or have shorted.

Solution

Verify and correct wiring.

Problem 4

Temperature reading is inaccurate.

Cause

- a) The zone is configured for the wrong type of thermistor (i.e., 2.8k vs. 10k)
- b) Temperature sensing may be affected by a source of ambient heat (ie., direct sunlight, or heat duct proximity).

Solution

- Manually configure the zone as described in Chapter 4.
- Try moving the sensor to a different location.

TEMPERATURE MONITORING *(continued)*

Cause

- c) Temperature may require calibration.

- d) The unit is using the wrong temperature scale (Fahrenheit vs. Celsius).

Solution

- After moving or placing the sensor away from ambient heat sources, the temperature may be calibrated to offset inaccurate normal reading by several degrees.
Refer to Chapter 4.
- Verify temperature scale.
Refer to Chapter 4.
-

4–20mA MONITORING:

Problem 1

Can't program 4–20mA range; or the unit won't read the 4–20mA sensor.

Cause

The zone isn't configured to read a 4–20mA sensor.

Solution

Press SET and CONFIGURE to program the zone. See Chapter 4 for information on zone configuration.

Problem 2

The zone input is not reading correctly.

Cause

- a) No power connected to the transducer.
- b) Incorrect wiring.
- c) The table range is incorrectly programmed.
- d) The input is not configured for 4–20mA.
- e) Multiple devices connected in loop.

Solution

- Connect a power supply as shown in Chapter 2.
- Inspect wiring. Make sure polarity is correct as shown in Chapter 2.
- Program the table range for the calibrated range of the transducer.
- Configure the zone for 4–20mA. Refer to Chapter 4.
- The 1800's zone is single-ended and terminates to ground. Because of this, the 1800 must be the last device in the loop, and in some cases the ONLY device. For certain installations, it may be necessary to use a signal isolator.

SOUND LEVEL MONITORING:

Problem 1

False high sound alarms occur frequently.

Cause	Solution
a) The programmed sound sensitivity results in over-sensitivity to non-alarm sound as well as alarm sound.	Reprogram the sound sensitivity (calibration). Refer to Chapter 4.
b) Sound Recognition Time is too short.	Lengthen the sound Recognition Time. Refer to Chapter 4.

Problem 2

High sound does not cause an alarm.

Cause	Solution
a) The microphone is not close enough to the high sound source, or the programmed sound setting results in a lack of sensitivity to high sound.	Move the microphone closer or reprogram the sound sensitivity. Refer to Chapter 4.
b) No remote microphone (optional) connected to the unit.	Connect a remote microphone to the Ext. Mic terminals.

OTHER MONITORING:

Problem 1

Alarm status of a zone is incorrect.

Cause

Incorrect zone configuration.

Solution

Reconfigure the zone. See Chapter 4.

Problem 2

False power-out alarms.

Cause

Programmed Recognition Time is too short.

Solution

AC power is often subject to brief interruptions. To avoid frequent, false alarms, increase the power Recognition Time. Refer to Chapter 4.

Problem 3

The 1800 does not recognize power failure.

Cause

- a) Battery is either incorrectly installed or drained.

- b) Recognition time setting is too long.

Solution

To verify proper battery function, unplug the unit and verify continued operation using battery only. If unit ceases to function, replace the battery. Refer to Appendix B.

Reprogram Recognition Time. Set the Recognition Time to the minimum required before a valid alarm occurs. If possible, test the condition by deliberately creating an alert condition. Refer to Chapter 4.

OTHER MONITORING *(continued)*

Problem 4

The 1800 does not recognize any alarm.

Cause	Solution
a) Zones for alarm are disabled.	Enable the zones for alarm. See Chapter 4.
b) Programmed Recognition Time is too long.	Reprogram Recognition Time. Set the Recognition Time to the minimum required for a monitored condition to become a valid alarm. If possible, test the condition by deliberately creating an alert condition. Refer to Chapter 4.

Problem 5

The batteries drain prematurely.

Cause	Solution
The unit's AC transformer is unplugged or for some other reason full AC power is not available to the unit.	The batteries will take over powering the unit when the AC transformer is unplugged from the 120 VAC outlet. When storing the unit, be sure to turn the power switch off.

If the solutions offered above do not appear to correct the problem, apply the following steps, in the order shown.

- Turn the power switch off.
- Wait one minute for the 1800 to completely power down.
- Turn the power switch on.
- Reconfigure the zones. Refer to Chapter 4.

Refer to *Chapter 2, Installation*, for additional information on batteries and installation procedures. Contact Sensaphone Technical Support toll-free at 1-877-373-2700.

APPENDIX D: 2.8 and 10K Thermistor Tables

2.8K Thermistor Data

Degrees Celsius	Resistance (Ohms)
-50	187,625
-40	94,206
-30	49,549
-20	27,180
-10	15,491
0	9,142
10	5,572
20	3,498
30	2,256
40	1,491
50	1,009
60	697
70	490
80	351

10K Thermistor Data

Degrees Celsius	Resistance (Ohms)
-30	135.2K
-20	78.91K
-10	47.54
0	29.49K
10	18.79K
20	12.25K
30	8,194
40	5,592
50	3,893
60	2,760
70	1,990

APPENDIX E: 1800 Technical Specifications

Environmental Inputs

Number of Zones: 8

Zone Connector: terminal block

Zone Types: N.O./N.C. contact, 2.8K (-109° to 115° F; -85° to 57°C) and 10K thermistor (-87° to 168° F; -66° to 76°C), and 4–20mA (-10,000 to 10,000)

Zone characteristics: 10K Ω to 5V (temperature/contact) or 237 Ohms to ground (4–20mA)

A/D Converter Resolution: 10 bits \pm 2 LSB

Zone Protection: Gas discharge tubes, PTC fuses, and fast acting diode clamps

Microphone

Internal: for recording custom voice messages

External (optional): For listening in to on-site sounds and high sound level alarms

- Mic Connector: terminal block
- Mic Type: Electret Condenser
- Mic Impedance: 2.2K

Phone Interface

Terminals for connection to a two-wire analog telephone line

Line seizure

LED Indicators: (8) Zone Alarms, Sound, Power, Battery OK, Phone in Use, Output On, and System On

Relay Output: 2A 120VAC/2A 24VDC—Programmable for automatic or manual switching

Power Supply

Power Supply: 120VDC/15VAC 60Hz 6W wall plug-in transformer

Power Consumption: 5 Watts

Power Protection: Metal Oxide Varistor

Battery Backup: 12V 2.2 AH sealed gel cell, provides up to 12 hours of back-up time

Environmental

Operating Temperature: 32° to 122°F (0° to 50°C)

Operating Humidity: 0–90% RH non-condensing

Storage Temperature: 32° to 140°F

Physical

Dimensions: 12.1"h x 8.0"w x 5.50"d

Weight: 8 lbs.

Enclosure: Indoor rated ABS Plastic & Polycarbonate w/clear window door

APPENDIX F: 1800 Quick Reference Guide

Communications

ID Number	Identification number of the 1800 [SET] or [WHAT IS] + [ID/POWER] Range=0–16 digits, Default=blank
ID Message	Custom message identifying the 1800 [SET] or [WHAT IS] + [MESSAGE] + [ID/POWER] Max:6 seconds Default=N/A
Zone Message	Message identifying the zone in alarm [SET] or [WHAT IS] + [MESSAGE] + [zone #] Max:3.75 seconds Default=N/A
Voice Repetitions	Number of times alarm message is repeated over the phone [SET] or [WHAT IS] + [VOICE REPS] Min: 1 reps, Max: 10 reps Default=3 reps
Dial-Out Phone Numbers	Phone numbers dialed to report alarm conditions [SET] or [WHAT IS] + [PHONE NUMBER] + [number 1–8] Max: 8 numbers, 48 digits each Default=N/A
Call Delay	Time delay until first call is made [SET] or [WHAT IS] + [CALL DELAY] (min:sec) Min: 00:00 Max: 60:00 Default=00:30
Intercall Time	Time delay between phone calls [SET] or [WHAT IS] + [INTERCALL TIME](min:sec) Min: 00:10, Max: 60:00 Default=01:00
Max Calls	Number of calls until unit self-acknowledges [SET] or [WHAT IS] + [MAX CALLS] Min: 0 calls, Max: 255 calls Default=100 calls
(TAD) Answering Device Compatibility	Allows 1800 to bypass answering devices on the same line [SENSOR ON/OFF] + [RINGS/TAD/*] On or Off, Default=Off
Rings Until Answer	Number of rings until unit answers an incoming call [SET] or [WHAT IS] + [RINGS/TAD/*] Min: 1 ring, Max: 15 rings DEFAULT=4 rings
Speaker Mute	Turns off the speaker during alarm conditions [SENSOR ON/OFF] + [MESSAGE/MUTE] On or Off Default=Off
Call Progress	Disables call progress detection feature [SENSOR ON/OFF] + [STATUS/CONFIGURE] On or Off Default=On

Callback Acknowledgment Allows alarm acknowledgment with 10 rings
[SENSOR ON/OFF] + [CODE]
On or Off Default=Disabled (*off*)

Tone or Pulse Dialing Dialing method—touch-tone or pulse
[SENSOR ON/OFF] + [PHONE NUMBER T/P]
On=Tone, Off=Pulse Default=Tone

Alarm Programming

Temp Alarm Limits High and low temperature alarm limits
[SET] or [WHAT IS] + [LOW LIMIT] or [HIGH LIMIT]+[zone #]
2.8K= Min:-109°F/-85°C Max:115°F/57°C
10K= Min:-87°F/-66°C Max:168°F/76°C
Default=Low: 0°F; High:100°F

4–20mA Table Range Defines upper and lower range of 4–20mA sensor
[SET] or [WHAT IS] + [TABLE RANGE] + [zone #]
Min: -10,000, Max: 10,000 Default=Low: 0, High:100

4–20mA Alarm Limits High and low alarm limits
[SET] or [WHAT IS] + [LOW LIMIT] or [HIGH LIMIT] + [zone #]
Min: -10,000, Max: 10,000 Default=Low: 0, High: 100

Zone Calibrate Offset correction factor [temp/4-20mA]
[SET] or [WHAT IS] + [CALIBRATE] + [zone #]
Min: -15°/-100, Max: 15°/100 Default=0

Auto. Zone Configuration Automatically configures all zones.
[SET] + [STATUS/CONFIGURE]
Default=n/a

Manual Zone Configuration To configure an individual zone type (*required* for 10K Temp)
[SENSOR ON/OFF] + [TABLE RANGE] + [zone #] + [type]
1 = NC, 2 = NO, 3 = 10K Temp, 4 = 4–20mA 6 = 2.8K Temp
Default=n/a

Recognition Time Zones 1–8 Length of time a fault condition must exist to trip an alarm
[SET] or [WHAT IS] + [REC TIME] + [zone #]
Min:00:00, Max: 272:00 Default=00:03 (min:sec)

Rec Time: Power Failure Length of time the power must be off to trip an alarm
[SET] or [WHAT IS] + [REC TIME] + [POWER]
Min: 00:00, Max: 272:00 Default=05:00 (min:sec)

Rec Time: High Sound Level Length of time the sound must be high to trip an alarm
[SET] or [WHAT IS] + [REC TIME] + [SOUND]
Min: 00:05, Max: 00:60 Default=00:08 (min:sec)

Sound Level Alarm Sensitivity Microphone sensitivity for high noise level alarm
[SET] or [WHAT IS] + [CALIBRATE] + [SOUND]
Min: 1 (most), Max: 255 (least) Default=32

Enable/Disable Zone Turns zone alarm detection on or off
[SENSOR ON/OFF] + [zone #]

On or Off Default=Enabled (on)

Power Alarm Enable/Disable Turns power alarm detection on or off
[SENSOR ON/OFF] + [POWER]
On or Off Default=Enabled (on)

Sound Alarm Enable/Disable Turns high sound level alarm detection on or off
[SENSOR ON/OFF] + [SOUND]
On or Off Default=Enabled (on)

Temperature Scale Selects between Fahrenheit and Celsius
[SENSOR ON/OFF] + [TEST/°F/°C]
On or Off Default=Fahrenheit (on)

Temperature-Only Status Report A limited status report that only includes inputs configured as temperature.
[WHAT IS] + [TEST]

Designating a Zone Unused Removes zone from status and alarm reports
[SENSOR ON/OFF] + [SET] + [zone #]
On or Off Default=on

Special Functions

Dial-Out Test Mode Simulates alarm to test telephone programming
[SET] + [TEST] + [# key 1-8] + [ENTER]
Default=none

Listen-In Time Length of listen-in time during call-in status report
[SET] or [WHAT IS] + [LISTEN TIME]
Min: 0 sec, Max: 255 sec Default=00:00 (min:sec)

Acknowledgment Code To create an individual user's 4-digit acknowledgment code
[SET] + [CODE] + [# key 1-8]
Default=1234 for user 1, no default for users 2-8

Date & Time Internal clock/calendar
[SET] or [WHAT IS] + [DATE/TIME/#]
Date: mmddyy, Time: hhmm Default=none

Alarm History Recites last 10 alarms
[WHAT IS] + [HISTORY]
Default=n/a

Reset History Clears the alarm history
[SET] + [HISTORY]
Default=n/a

Switch Output Turns output relay on or off (in manual mode)
[SENSOR ON/OFF] + [OUTPUT]
On or Off Default=off

Output Mode	Program relay output as manual or automatic for specific zone [SET] or [WHAT IS] + [OUTPUT] + [mode number] Default=none
Keypad Unlock	Allows programming changes [WHAT IS] + [ENTER/LOCK] + [4 digit code] Default=unlocked
Keypad Lock	Prohibits programming changes [SET] + [ENTER/LOCK] + [4 digit code] Default=unlocked

Press [ENTER] after all Key Sequences starting with [SET].
Use [SET] to establish parameters, [WHAT IS] to verify them.

SPECIAL KEY FUNCTIONS

RING/TAD/*

Used to enter a minus sign for negative alarm limits or calibrations.

DIALOUT CODES

- CODE 1 Inserts a 2-second pause; precedes a dialout number for blind dialing
- CODE 2 Inserts a “Wait for answer”
- CODE 3 Numeric pager call type
- CODE 4 Alphanumeric pager type
- CODE 5 Alphanumeric pager ID #
- CODE 6 Change to Touch-Tone dialing

APPENDIX G: Accessories

The sensors and accessories listed below are available from Phonetics, Inc., and represent the most commonly used devices. Other dry contact sensors or 4–20mA transducers, designed for more specialized applications, may also be used. Commercial or industrial electrical supply houses can provide devices to monitor virtually any condition. For further information, contact a Sensaphone Sales Associate toll-free at 1-877-373-2700.

<u>PART NUMBER</u>	<u>SENSOR/ SWITCH</u>
FGD-0006	Magnetic Reed Door and Window Switch
FGD-0007	Passive Infrared Motion Detection Sensor
FGD-0010	50' two-conductor #22AWG shielded accessory Cable
FGD-0013	Spot Water Detection Sensor
FGD-0022	Temp° Alert Temperature Switch
FGD-0067	Surge Suppressor for Power and Phone
FGD-0027	Humidistat Humidity Switch
FGD-0049	Smoke Detector for 110VAC w/ Battery Backup
FGD-0052	Humidity Sensor
FGD-0053	Power Supply for 4-20mA Sensor
FGD-0054	Power-Out Alert™ Power Failure Switch
FGD-0056	Zone Water Detection Sensor
FGD-0057	External Microphone
FGD-0063	10' additional Water Rope for FGD-0056
FGD-0101	2.8K Weatherproof Temperature Sensor
FGD-0102	10K Weatherproof Temperature Sensor
FGD-0104	10K Outdoor Air Temperature Sensor
FGD-0205	Multipoint Wireless I/O

APPENDIX H: Returning Your 1800 for Repair

In the event that the 1800 does not function properly, we suggest that you do the following:

1. Record your observations regarding the 1800's malfunction.
2. Call Sensaphone Technical Support toll-free at 1-877-373-2700 or e-mail support@sensaphone.com prior to sending the unit to Sensaphone for repair. Our product support specialists are able to diagnose and correct many unit setup and programming problems over the phone.

If the unit must be sent to Phonetics, Inc. for Servicing, please do the following:

1. Turn the power switch Off, disconnect all wiring and unplug the unit.
2. Carefully pack the unit to avoid damage in transit. Use the original container (if available) or a sturdy shipping box.
3. To avoid shipping delays, you must include the following information:
 - a) Your name, address and telephone number.
 - b) A note explaining the problem.
4. Ship your package to the address below:

SERVICE DEPARTMENT
Phonetics, Inc.
901 Tryens Road
Aston, PA 19014

5. Ship prepaid and insured via UPS or US Mail to ensure a traceable shipment with recourse for damage or replacement.

Test Log

Date	Inputs		Dialout		Call-In		Battery				Tested By
	Pass <input type="checkbox"/>	Fail <input type="checkbox"/>	Pass <input type="checkbox"/>	Fail <input type="checkbox"/>	Pass <input type="checkbox"/>	Fail <input type="checkbox"/>	Pass <input type="checkbox"/>	Fail <input type="checkbox"/>	Pass <input type="checkbox"/>	Fail <input type="checkbox"/>	
	Pass <input type="checkbox"/>	Fail <input type="checkbox"/>	Pass <input type="checkbox"/>	Fail <input type="checkbox"/>	Pass <input type="checkbox"/>	Fail <input type="checkbox"/>	Pass <input type="checkbox"/>	Fail <input type="checkbox"/>	Pass <input type="checkbox"/>	Fail <input type="checkbox"/>	
	Pass <input type="checkbox"/>	Fail <input type="checkbox"/>	Pass <input type="checkbox"/>	Fail <input type="checkbox"/>	Pass <input type="checkbox"/>	Fail <input type="checkbox"/>	Pass <input type="checkbox"/>	Fail <input type="checkbox"/>	Pass <input type="checkbox"/>	Fail <input type="checkbox"/>	
	Pass <input type="checkbox"/>	Fail <input type="checkbox"/>	Pass <input type="checkbox"/>	Fail <input type="checkbox"/>	Pass <input type="checkbox"/>	Fail <input type="checkbox"/>	Pass <input type="checkbox"/>	Fail <input type="checkbox"/>	Pass <input type="checkbox"/>	Fail <input type="checkbox"/>	
	Pass <input type="checkbox"/>	Fail <input type="checkbox"/>	Pass <input type="checkbox"/>	Fail <input type="checkbox"/>	Pass <input type="checkbox"/>	Fail <input type="checkbox"/>	Pass <input type="checkbox"/>	Fail <input type="checkbox"/>	Pass <input type="checkbox"/>	Fail <input type="checkbox"/>	
	Pass <input type="checkbox"/>	Fail <input type="checkbox"/>	Pass <input type="checkbox"/>	Fail <input type="checkbox"/>	Pass <input type="checkbox"/>	Fail <input type="checkbox"/>	Pass <input type="checkbox"/>	Fail <input type="checkbox"/>	Pass <input type="checkbox"/>	Fail <input type="checkbox"/>	
	Pass <input type="checkbox"/>	Fail <input type="checkbox"/>	Pass <input type="checkbox"/>	Fail <input type="checkbox"/>	Pass <input type="checkbox"/>	Fail <input type="checkbox"/>	Pass <input type="checkbox"/>	Fail <input type="checkbox"/>	Pass <input type="checkbox"/>	Fail <input type="checkbox"/>	
	Pass <input type="checkbox"/>	Fail <input type="checkbox"/>	Pass <input type="checkbox"/>	Fail <input type="checkbox"/>	Pass <input type="checkbox"/>	Fail <input type="checkbox"/>	Pass <input type="checkbox"/>	Fail <input type="checkbox"/>	Pass <input type="checkbox"/>	Fail <input type="checkbox"/>	
	Pass <input type="checkbox"/>	Fail <input type="checkbox"/>	Pass <input type="checkbox"/>	Fail <input type="checkbox"/>	Pass <input type="checkbox"/>	Fail <input type="checkbox"/>	Pass <input type="checkbox"/>	Fail <input type="checkbox"/>	Pass <input type="checkbox"/>	Fail <input type="checkbox"/>	
	Pass <input type="checkbox"/>	Fail <input type="checkbox"/>	Pass <input type="checkbox"/>	Fail <input type="checkbox"/>	Pass <input type="checkbox"/>	Fail <input type="checkbox"/>	Pass <input type="checkbox"/>	Fail <input type="checkbox"/>	Pass <input type="checkbox"/>	Fail <input type="checkbox"/>	
	Pass <input type="checkbox"/>	Fail <input type="checkbox"/>	Pass <input type="checkbox"/>	Fail <input type="checkbox"/>	Pass <input type="checkbox"/>	Fail <input type="checkbox"/>	Pass <input type="checkbox"/>	Fail <input type="checkbox"/>	Pass <input type="checkbox"/>	Fail <input type="checkbox"/>	
	Pass <input type="checkbox"/>	Fail <input type="checkbox"/>	Pass <input type="checkbox"/>	Fail <input type="checkbox"/>	Pass <input type="checkbox"/>	Fail <input type="checkbox"/>	Pass <input type="checkbox"/>	Fail <input type="checkbox"/>	Pass <input type="checkbox"/>	Fail <input type="checkbox"/>	
	Pass <input type="checkbox"/>	Fail <input type="checkbox"/>	Pass <input type="checkbox"/>	Fail <input type="checkbox"/>	Pass <input type="checkbox"/>	Fail <input type="checkbox"/>	Pass <input type="checkbox"/>	Fail <input type="checkbox"/>	Pass <input type="checkbox"/>	Fail <input type="checkbox"/>	
	Pass <input type="checkbox"/>	Fail <input type="checkbox"/>	Pass <input type="checkbox"/>	Fail <input type="checkbox"/>	Pass <input type="checkbox"/>	Fail <input type="checkbox"/>	Pass <input type="checkbox"/>	Fail <input type="checkbox"/>	Pass <input type="checkbox"/>	Fail <input type="checkbox"/>	
	Pass <input type="checkbox"/>	Fail <input type="checkbox"/>	Pass <input type="checkbox"/>	Fail <input type="checkbox"/>	Pass <input type="checkbox"/>	Fail <input type="checkbox"/>	Pass <input type="checkbox"/>	Fail <input type="checkbox"/>	Pass <input type="checkbox"/>	Fail <input type="checkbox"/>	
	Pass <input type="checkbox"/>	Fail <input type="checkbox"/>	Pass <input type="checkbox"/>	Fail <input type="checkbox"/>	Pass <input type="checkbox"/>	Fail <input type="checkbox"/>	Pass <input type="checkbox"/>	Fail <input type="checkbox"/>	Pass <input type="checkbox"/>	Fail <input type="checkbox"/>	
	Pass <input type="checkbox"/>	Fail <input type="checkbox"/>	Pass <input type="checkbox"/>	Fail <input type="checkbox"/>	Pass <input type="checkbox"/>	Fail <input type="checkbox"/>	Pass <input type="checkbox"/>	Fail <input type="checkbox"/>	Pass <input type="checkbox"/>	Fail <input type="checkbox"/>	
	Pass <input type="checkbox"/>	Fail <input type="checkbox"/>	Pass <input type="checkbox"/>	Fail <input type="checkbox"/>	Pass <input type="checkbox"/>	Fail <input type="checkbox"/>	Pass <input type="checkbox"/>	Fail <input type="checkbox"/>	Pass <input type="checkbox"/>	Fail <input type="checkbox"/>	
	Pass <input type="checkbox"/>	Fail <input type="checkbox"/>	Pass <input type="checkbox"/>	Fail <input type="checkbox"/>	Pass <input type="checkbox"/>	Fail <input type="checkbox"/>	Pass <input type="checkbox"/>	Fail <input type="checkbox"/>	Pass <input type="checkbox"/>	Fail <input type="checkbox"/>	
	Pass <input type="checkbox"/>	Fail <input type="checkbox"/>	Pass <input type="checkbox"/>	Fail <input type="checkbox"/>	Pass <input type="checkbox"/>	Fail <input type="checkbox"/>	Pass <input type="checkbox"/>	Fail <input type="checkbox"/>	Pass <input type="checkbox"/>	Fail <input type="checkbox"/>	

Date	Inputs		Dialout		Call-In		Battery				Tested By
	Pass <input type="checkbox"/>	Fail <input type="checkbox"/>	Pass <input type="checkbox"/>	Fail <input type="checkbox"/>	Pass <input type="checkbox"/>	Fail <input type="checkbox"/>	Pass <input type="checkbox"/>	Fail <input type="checkbox"/>	Pass <input type="checkbox"/>	Fail <input type="checkbox"/>	
	Pass <input type="checkbox"/>	Fail <input type="checkbox"/>	Pass <input type="checkbox"/>	Fail <input type="checkbox"/>	Pass <input type="checkbox"/>	Fail <input type="checkbox"/>	Pass <input type="checkbox"/>	Fail <input type="checkbox"/>	Pass <input type="checkbox"/>	Fail <input type="checkbox"/>	
	Pass <input type="checkbox"/>	Fail <input type="checkbox"/>	Pass <input type="checkbox"/>	Fail <input type="checkbox"/>	Pass <input type="checkbox"/>	Fail <input type="checkbox"/>	Pass <input type="checkbox"/>	Fail <input type="checkbox"/>	Pass <input type="checkbox"/>	Fail <input type="checkbox"/>	
	Pass <input type="checkbox"/>	Fail <input type="checkbox"/>	Pass <input type="checkbox"/>	Fail <input type="checkbox"/>	Pass <input type="checkbox"/>	Fail <input type="checkbox"/>	Pass <input type="checkbox"/>	Fail <input type="checkbox"/>	Pass <input type="checkbox"/>	Fail <input type="checkbox"/>	
	Pass <input type="checkbox"/>	Fail <input type="checkbox"/>	Pass <input type="checkbox"/>	Fail <input type="checkbox"/>	Pass <input type="checkbox"/>	Fail <input type="checkbox"/>	Pass <input type="checkbox"/>	Fail <input type="checkbox"/>	Pass <input type="checkbox"/>	Fail <input type="checkbox"/>	
	Pass <input type="checkbox"/>	Fail <input type="checkbox"/>	Pass <input type="checkbox"/>	Fail <input type="checkbox"/>	Pass <input type="checkbox"/>	Fail <input type="checkbox"/>	Pass <input type="checkbox"/>	Fail <input type="checkbox"/>	Pass <input type="checkbox"/>	Fail <input type="checkbox"/>	
	Pass <input type="checkbox"/>	Fail <input type="checkbox"/>	Pass <input type="checkbox"/>	Fail <input type="checkbox"/>	Pass <input type="checkbox"/>	Fail <input type="checkbox"/>	Pass <input type="checkbox"/>	Fail <input type="checkbox"/>	Pass <input type="checkbox"/>	Fail <input type="checkbox"/>	
	Pass <input type="checkbox"/>	Fail <input type="checkbox"/>	Pass <input type="checkbox"/>	Fail <input type="checkbox"/>	Pass <input type="checkbox"/>	Fail <input type="checkbox"/>	Pass <input type="checkbox"/>	Fail <input type="checkbox"/>	Pass <input type="checkbox"/>	Fail <input type="checkbox"/>	
	Pass <input type="checkbox"/>	Fail <input type="checkbox"/>	Pass <input type="checkbox"/>	Fail <input type="checkbox"/>	Pass <input type="checkbox"/>	Fail <input type="checkbox"/>	Pass <input type="checkbox"/>	Fail <input type="checkbox"/>	Pass <input type="checkbox"/>	Fail <input type="checkbox"/>	
	Pass <input type="checkbox"/>	Fail <input type="checkbox"/>	Pass <input type="checkbox"/>	Fail <input type="checkbox"/>	Pass <input type="checkbox"/>	Fail <input type="checkbox"/>	Pass <input type="checkbox"/>	Fail <input type="checkbox"/>	Pass <input type="checkbox"/>	Fail <input type="checkbox"/>	
	Pass <input type="checkbox"/>	Fail <input type="checkbox"/>	Pass <input type="checkbox"/>	Fail <input type="checkbox"/>	Pass <input type="checkbox"/>	Fail <input type="checkbox"/>	Pass <input type="checkbox"/>	Fail <input type="checkbox"/>	Pass <input type="checkbox"/>	Fail <input type="checkbox"/>	
	Pass <input type="checkbox"/>	Fail <input type="checkbox"/>	Pass <input type="checkbox"/>	Fail <input type="checkbox"/>	Pass <input type="checkbox"/>	Fail <input type="checkbox"/>	Pass <input type="checkbox"/>	Fail <input type="checkbox"/>	Pass <input type="checkbox"/>	Fail <input type="checkbox"/>	
	Pass <input type="checkbox"/>	Fail <input type="checkbox"/>	Pass <input type="checkbox"/>	Fail <input type="checkbox"/>	Pass <input type="checkbox"/>	Fail <input type="checkbox"/>	Pass <input type="checkbox"/>	Fail <input type="checkbox"/>	Pass <input type="checkbox"/>	Fail <input type="checkbox"/>	
	Pass <input type="checkbox"/>	Fail <input type="checkbox"/>	Pass <input type="checkbox"/>	Fail <input type="checkbox"/>	Pass <input type="checkbox"/>	Fail <input type="checkbox"/>	Pass <input type="checkbox"/>	Fail <input type="checkbox"/>	Pass <input type="checkbox"/>	Fail <input type="checkbox"/>	
	Pass <input type="checkbox"/>	Fail <input type="checkbox"/>	Pass <input type="checkbox"/>	Fail <input type="checkbox"/>	Pass <input type="checkbox"/>	Fail <input type="checkbox"/>	Pass <input type="checkbox"/>	Fail <input type="checkbox"/>	Pass <input type="checkbox"/>	Fail <input type="checkbox"/>	
	Pass <input type="checkbox"/>	Fail <input type="checkbox"/>	Pass <input type="checkbox"/>	Fail <input type="checkbox"/>	Pass <input type="checkbox"/>	Fail <input type="checkbox"/>	Pass <input type="checkbox"/>	Fail <input type="checkbox"/>	Pass <input type="checkbox"/>	Fail <input type="checkbox"/>	
	Pass <input type="checkbox"/>	Fail <input type="checkbox"/>	Pass <input type="checkbox"/>	Fail <input type="checkbox"/>	Pass <input type="checkbox"/>	Fail <input type="checkbox"/>	Pass <input type="checkbox"/>	Fail <input type="checkbox"/>	Pass <input type="checkbox"/>	Fail <input type="checkbox"/>	
	Pass <input type="checkbox"/>	Fail <input type="checkbox"/>	Pass <input type="checkbox"/>	Fail <input type="checkbox"/>	Pass <input type="checkbox"/>	Fail <input type="checkbox"/>	Pass <input type="checkbox"/>	Fail <input type="checkbox"/>	Pass <input type="checkbox"/>	Fail <input type="checkbox"/>	
	Pass <input type="checkbox"/>	Fail <input type="checkbox"/>	Pass <input type="checkbox"/>	Fail <input type="checkbox"/>	Pass <input type="checkbox"/>	Fail <input type="checkbox"/>	Pass <input type="checkbox"/>	Fail <input type="checkbox"/>	Pass <input type="checkbox"/>	Fail <input type="checkbox"/>	
	Pass <input type="checkbox"/>	Fail <input type="checkbox"/>	Pass <input type="checkbox"/>	Fail <input type="checkbox"/>	Pass <input type="checkbox"/>	Fail <input type="checkbox"/>	Pass <input type="checkbox"/>	Fail <input type="checkbox"/>	Pass <input type="checkbox"/>	Fail <input type="checkbox"/>	
	Pass <input type="checkbox"/>	Fail <input type="checkbox"/>	Pass <input type="checkbox"/>	Fail <input type="checkbox"/>	Pass <input type="checkbox"/>	Fail <input type="checkbox"/>	Pass <input type="checkbox"/>	Fail <input type="checkbox"/>	Pass <input type="checkbox"/>	Fail <input type="checkbox"/>	
	Pass <input type="checkbox"/>	Fail <input type="checkbox"/>	Pass <input type="checkbox"/>	Fail <input type="checkbox"/>	Pass <input type="checkbox"/>	Fail <input type="checkbox"/>	Pass <input type="checkbox"/>	Fail <input type="checkbox"/>	Pass <input type="checkbox"/>	Fail <input type="checkbox"/>	