

MOD. 180

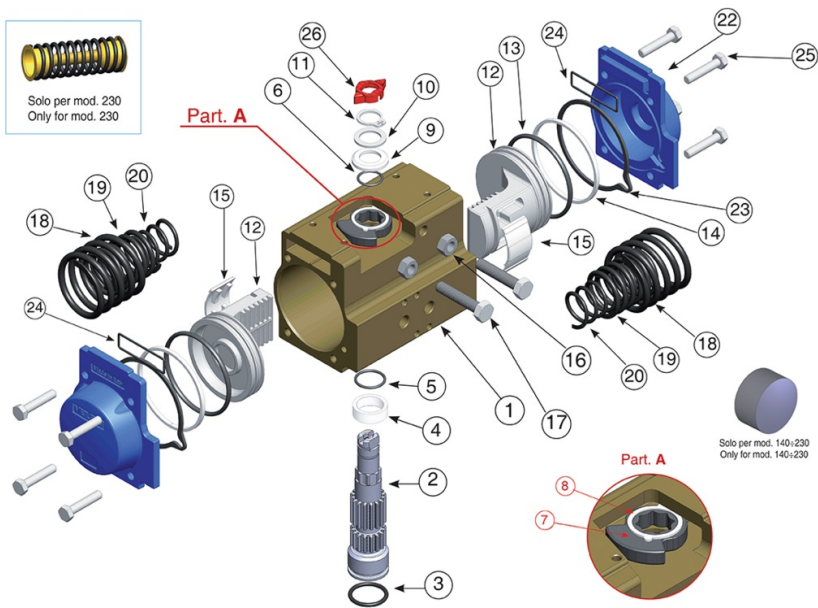

Technical specifications

Drawing



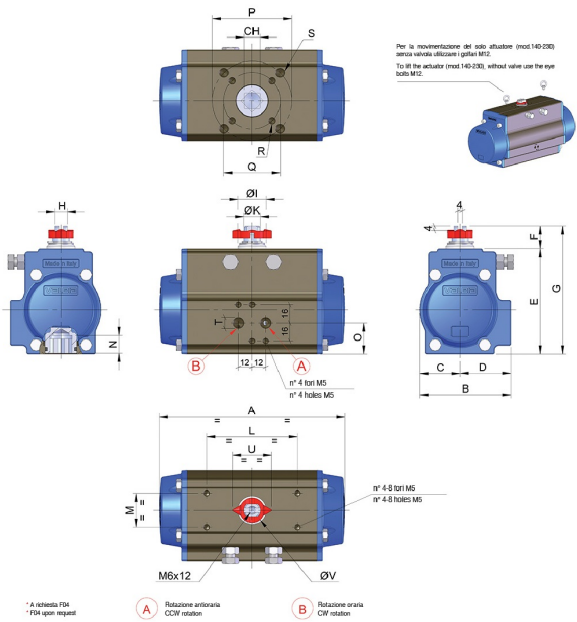

Materials

POSITION	PART NAME	MATERIAL	TREATMENT	N.° PIECES
1	Body	Extruded aluminium	Ossidato duro - Hard anodized	1
2	Anti-blowout pinion	Steel	Nichelato - Nickel plated	1
3*	O-ring	FKM (VITON)	-	1
4*	Spacer ring	POM	-	1
5*	O-ring	FKM (VITON)	-	1
6*	O-ring	FKM (VITON)	-	1
7	Cam	Stainless steel	-	1
8	Spacer	POM	-	1
9*	Anello sotto seeger -Spacer	POM	-	1
10	Washer	Stainless steel	-	1
11**	Snap ring	Steel	Nichelato - Nickel plated	1
12	Piston	Die cast aluminium	-	2
13*	O-ring	FKM (VITON)	-	2
14*	Antifriction ring	POM	-	2
15*	Thrust block	POM	-	2 [4]
16	Stop bolt retaining nut	Stainless steel	-	2
17	Stop bolt	Stainless steel	-	2
18	External spring	Steel	Verniciata - Painted	-
19***	Central spring	Steel	Verniciata - Painted	-
20	Internal spring	Steel	Verniciata - Painted	-
21	Left end cap	Die cast aluminium	Verniciata - Painted	1
22	Right end cap	Die cast aluminium	Verniciata - Painted	1
23	End cap seats	FKM (VITON)	-	2
24	O-ring	FKM (VITON)	-	2
25	End cap fixing screw	Stainless steel	-	8
26	Position indicator	Thermoplastic rubber TPE	-	1

Table

SIZE	PATTERN ISO 5211	CH	A	B	C	D	E	F	G	H	ØI	ØK	L	M	N	O	P	Q	R	S	T NPT	U	ØV
180	F10 - F14	36	19.41	8.38	3.86	4.53	9.96	1.18	11.14	1.42	2.44	1.77	3.15/5.12	1.18	1.69	3.90	5.51	4.02	3/8-16 UNC 2Bx0.59"	5/8-11 UNC 2Bx0.98"	1/4"	3.17	2.36