



INSTRUMENTS

OX-04

Operator's Manual

Part Number: 71-0619

Revision: B

Released: 10/5/23

RKI Instruments, Inc.
www.rkiinstruments.com

WARNING

Read and understand this instruction manual before operating instrument. Improper use of the gas monitor could result in bodily harm or death.

Maintenance of the gas monitor is essential for proper operation and correct readings.

Bump test the instrument before each day's use with a known concentration of each target gas. A bump test can be done in User Mode's BUMP item or by applying gas in Measuring Mode. The instrument does not need to be calibrated unless it does not pass the User Mode bump test or does not respond appropriately, as defined by the user, in Measuring Mode. For more information about bump test and calibration requirements, see IEC 60079-29-2.

04 Series Quick Reference Guide
 Applies to models: HS-04, CO-04, CO-04C, OX-04, CX-04, SC-04 (NH₃,Cl₂,HCN,NO₂,PH₃,SO₂)

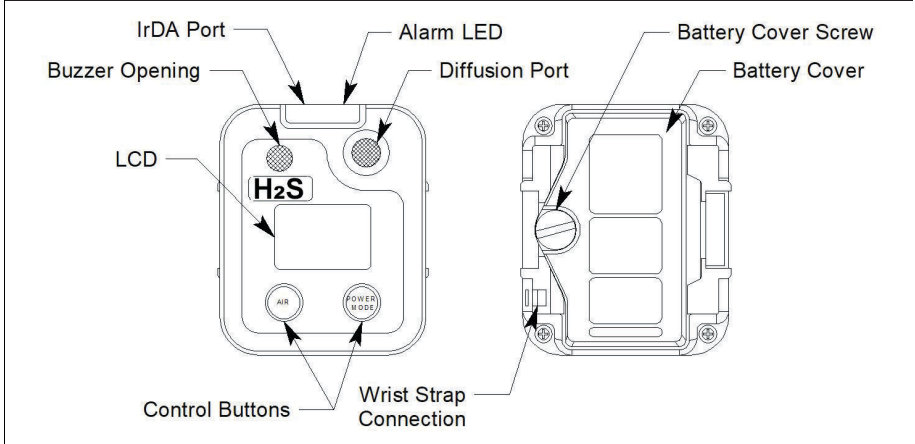

Turning on your instrument

- Press and hold POWER MODE button. Release it when the instrument beeps.
- When warm-up sequence is completed, the normal operating screen is displayed.
- If Cal Limit Display or Bump Test Limit Display are on and calibration or bump test is due, see operator's manual for warm-up sequence.

Note: If a failure occurs, press and release the POWER MODE button. The instrument cannot be used if a sensor failure occurs. Replace the failed sensor.

Performing fresh air adjustment

- Press and hold the AIR button in a fresh air environment. The LCD will display "HOLD".
- Release the AIR button when "RELEASE" is displayed.
- The instrument will set reading to 0 ppm for all models except CX-04 and OX-04 (O₂ reading set to 20.9% Vol.)

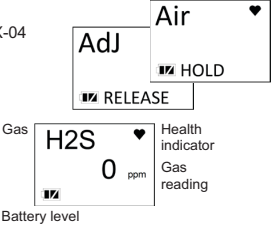

Normal operating mode

- The gas concentration is displayed.
- Battery charge level is indicated in lower left corner.
- The heart symbol displayed in the upper right corner flashes while the instrument is functioning properly.

Turning the instrument off

- Press and hold the POWER MODE button for approximately five seconds to turn off the unit.



Statement of Quality and Conformance

RKI Instruments, Inc. certifies that this instrument has been tested, inspected, and calibrated by a qualified technician and was found to meet or exceed the manufacturer's specifications per ISO 9001 Quality System.

Register your Product here:
www.rkiinstruments.com/registration

RKI Instruments, Inc. • 33248 Central Avenue, Union City, CA 94587
 Phone: (510) 441-5656 • (800) 754-5165 • Fax: (510) 441-5650
www.rkiinstruments.com

Table of Contents

Chapter 1: Introduction	8
Overview	8
About the OX-04	8
Specifications	8
About this Manual	10
Chapter 2: Description	11
Overview	11
Instrument Description	11
<i>Case</i>	11
<i>LCD</i>	11
<i>Control Buttons</i>	12
<i>Alarm LED</i>	12
<i>Buzzer</i>	12
<i>Vibrator</i>	12
<i>Sensor</i>	13
<i>Hydrophobic Filter</i>	13
<i>Infrared Communications Port</i>	13
<i>Batteries</i>	13
Standard Accessories	14
<i>Alligator Clip</i>	14
<i>Protective Rubber Boot</i>	15
Optional Accessories	15
<i>Belt Clip</i>	15
<i>Wrist Strap</i>	15
<i>Calibration Cup</i>	16
<i>IrDA/USB Cable</i>	16
Chapter 3: Measuring Mode	17
Overview	17
Start Up	17
<i>Turning On the OX-04</i>	17
<i>Performing a Demand Zero</i>	22
<i>Turning Off the OX-04</i>	22
Measuring Mode Operation	23
<i>Monitoring an Area</i>	23

Alarms	24
<i>Alarm Indicators</i>	24
<i>Responding to Alarms</i>	26
Data Logging	28

Chapter 4: Display Mode30

Tips for Using Display Mode	30
Peak Screen (PEAK).....	31
User ID Screen (USER ID).....	31
Station ID Screen (STN ID)	32
Last Successful Calibration Date (CAL.DATA).....	33
Last Successful Bump Test Screen (BP.DATA)	34
Date/Time Screen (DATE)	34
Temperature Screen (TEMP)	34
Alarm Points Screen (ALARM--P)	35
Adjusting the Buzzer Volume (BUZZ.VOL)	36

Chapter 5: User Mode and Calibration.....37

Overview.....	37
Entering User Mode	40
Tips for Using User Mode	41
Performing a Bump Test (BUMP)	42
Performing a Calibration (GAS CAL)	44
Setting Calibration Parameters (CAL SET)	54
Setting Bump Test Parameters (BUMP.SET).....	56
Alarm Settings (ALARM--P).....	61
Updating the Lunch Break Setting (LUNCH)	63
Setting the Confirmation Beep and Non-Compliance Indicator (BEEP).....	63
Updating the Backlight Time (BL TIME).....	65
Turning the Key Tone On/Off (KEY.TONE)	65
Display Mode Items (DISP.SET)	66
Zero Suppression (ZERO.SUP)	66
Zero Follower (ZERO.FLW)	66
Turning Easy Calibration On/Off (E-CAL)	67
Setting the Date/Time (DATE)	67
Turning the Password On/Off (PASS-W).....	68
Viewing the ROM/SUM (ROM/SUM).....	69
Entering Measuring Mode (START)	69

Chapter 6: Maintenance70

Overview	70
----------------	----

Troubleshooting	70
Replacing the Batteries	71
Replacing the Hydrophobic Filter	74
Replacing the Sensor	76
Chapter 7: General Parts List	78
Appendix A: Maintenance Mode	78
Overview	79
Entering Maintenance Mode	80
Tips for Using Maintenance Mode	81
Performing a Calibration (GAS CAL)	82
Performing a Gas Test (GAS.TEST).....	82
Sensor/Battery Replacement Date (SEN.DATE)	83
Performing a Bump Test (BUMP)	84
Setting Alarms to Latching or Self-Resetting (LATCH)	84
Turning the Demand Zero Function On/Off (D.ZERO).....	85
Turning the Auto Zero Function On/Off (A.ZERO).....	85
Turning the ID Display Function On/Off (ID DISP)	86
Turning the Zero Suppression On/Off (ZERO.SUP)	86
Turning the Zero Follower On/Off (ZERO.FLW)	86
User Mode Zero Suppression (ZSUP.DSP)	86
User Mode Zero Follower (ZFLW.DSP)	87
Cylinder Setting (CYL.DISP).....	87
Setting the Date/Time (DATE)	87
Turning the Password On/Off (PASS-W).....	88
Viewing the ROM/SUM (ROM/SUM).....	89
Performing a Default (M.DEF).....	89
Entering Measuring Mode (START)	90
Appendix B: Gas Select Mode	91
Overview.....	91
Entering Gas Select Mode	91
Tips for Using Gas Select Mode.....	92
Saving the Alarm Points (SAVE-AP)	92
Turning the Calibration Max Span On/Off (MAX.SPAN).....	93
Stealth and Vibrator Settings (STEALTH)	94
Exiting Gas Select Mode (START).....	95
Warranty	96

WARNING: *Understand manual before operating. This is an intrinsically safe product. Substitution of components may impair intrinsic safety. To prevent ignition of a hazardous atmosphere, batteries must only be changed or charged in an area known to be nonhazardous. Not tested in oxygen enriched atmospheres (above 21%).*

AVERTISSEMENT: *Comprendre le manuel avant de l'utiliser. Ceci est un produit intrinsèquement sûr. La substitution de composants peut nuire à la sécurité intrinsèque. Pour éviter l'inflammation d'une atmosphère dangereuse, les batteries ne doivent être remplacées ou chargées que dans une zone non dangereuse. Non testé dans des atmosphères enrichies en oxygène (plus de 21%).*

Chapter 1: Introduction

Overview

This chapter briefly describes the OX-04 gas monitor. This chapter also describes the *OX-04 Operator's Manual* (this document). Table 2 at the end of this chapter lists the specifications for the OX-04.

About the OX-04

Using an advanced detection system, the OX-04 personal gas monitor detects the presence of oxygen (O₂). The OX-04's compact size and easy-to-use design make it ideally suited for a wide range of applications, including sewage treatment plants, utility manholes, tunnels, hazardous waste sites, power stations, petrochemical refineries, mines, paper mills, drilling rigs, and fire fighting stations. The OX-04 offers a full range of features, including the following:

- Liquid crystal display (LCD) for complete and understandable information at a glance
 - Ultrabright alarm LED
 - Distinctive audible/vibrating alarms for dangerous gas conditions and audible alarms for unit malfunction
 - Microprocessor control for reliability, ease of use, and advanced capabilities
 - Data logging functions
 - Alarm trend data
 - Over range alarms
 - Peak reading
 - Built-in time function
 - Lunch break feature
 - QPS "C/US" classification for Class I, Division I, Groups A, B, C, and D hazardous atmospheres
-

Specifications

Table 1: Standard Sensor Specifications/Alarm Points

Detection Range	0 - 40.0% volume
Reading Increment	0.1% vol.
Warning Factory Setpoint	18.0% volume (decreasing)
Alarm Factory Setpoint	19.5% volume (decreasing)
Alarm H Factory Setpoint	23.5% volume (increasing)

Table 2: OX-04 Specifications

Sampling Method	Diffusion
Response Time	T90 Within 30 Seconds
Display	Graphics LCD Display
Operating Temperature & Humidity	Continuous environment: -20°C to 50°C/10 to 90% RH Temporary environment (up to 15 minutes): -40°C to 60°C/0 to 95% RH
Safety/Regulatory	<ul style="list-style-type: none"> • ATEX: Certificate Number DEKRA 19ATEX0097 II 1G Ex ia IIC T4 Ga (with alkaline batteries) II 1G Ex ia IIC T3, Ga (with Ni-MH batteries) • IECEx: Certificate Number IECEx DEK 19.0059 Ex ia IIC T4 Ga (with alkaline batteries) Ex ia IIC T3 Ga (with Ni-MH batteries) • QPS classified, “C/US”, as Intrinsically Safe. Exia. Class I, Groups A, B, C, & D.
Instrument Power Information	<ul style="list-style-type: none"> • Operating Voltage: 3.0 V • Operating Current: 1.0 mA • Operating Power: 3.0 mW
Power Supply	2 AAA alkaline batteries; 1.5V, 1.175 AH (Duracell MN2400 or PC2400) OR 2 AAA Ni-MH batteries; 1.2V, 800 mAH (Panasonic Eneloop BK-4MCC)
Continuous Operating Hours @ 25 °C	Alkaline Batteries: 3,000 hours in Measuring Mode (Non Alarm Operation, Fully Charged) Ni-MH Batteries: 2,000 hours in Measuring Mode (Non Alarm Operation, Fully Charged)
Case	High-impact Plastic, RF Shielded, Dust and Weather Proof (IP67)
Standard Accessories	<ul style="list-style-type: none"> • Alligator clip • Rubber boot
Optional Accessories	<ul style="list-style-type: none"> • Belt clip • Wrist strap • Calibration cup • Datalogging and Setup Programs (Windows® 7, 8, 10, and 11), available at www.rkiinstruments.com/04series • IrDA/USB Cable for connecting to a computer when using the Datalogging and Setup Programs (not needed if computer has an infrared port)
Dimensions and Weight	Approximately 67(H) x 54(W) x 24(D) mm (2.6”H x 2.1”W x 0.9”D) Approximately 93 g (3.3 oz.)

About this Manual

The *OX-04 Operator's Manual* uses the following conventions for notes, cautions, and warnings.

NOTE: Describes additional or critical information.

CAUTION: *Describes potential damage to equipment.*

WARNING: *Describes potential danger that can result in injury or death.*

Chapter 2: Description

Overview

This chapter describes the OX-04 instrument and its accessories.

Instrument Description

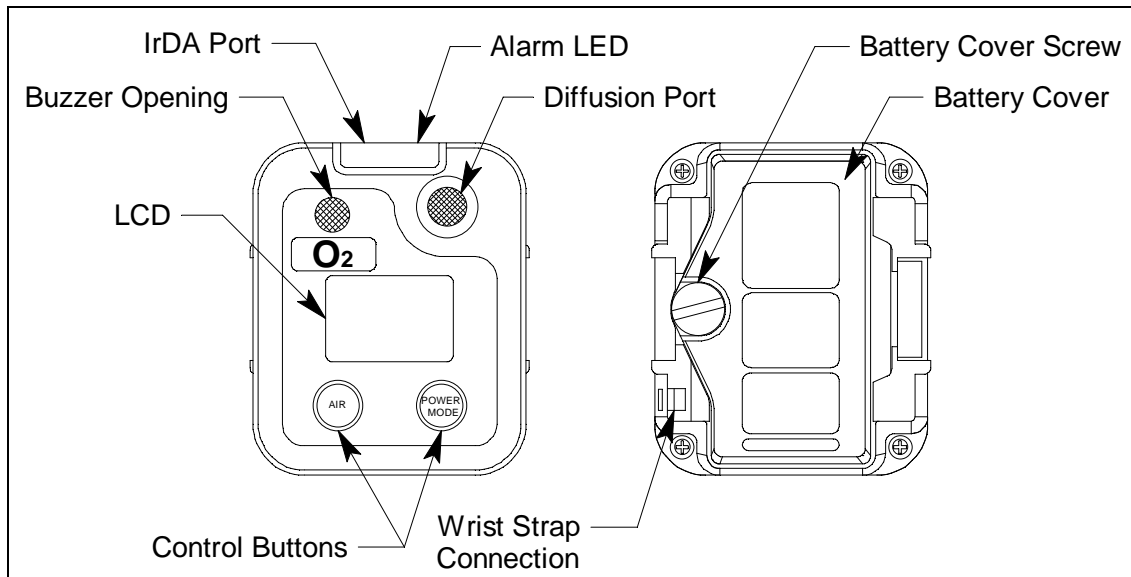

Figure 1: Component Location

Case

The OX-04's sturdy, high-impact plastic case is radio frequency (RF) resistant and is suitable for use in many environmental conditions, indoors and out. The case is dust proof and water resistant. A clear plastic window is located on the front of the case for viewing the LCD. The sensor retainer is located on the right side of the case and allows access to the filters and sensor. A feature in the lower left corner of the rear case is used to install the optional wrist strap.

LCD

A digital LCD (liquid crystal display) is visible through a clear plastic window in the top case. The LCD shows the gas reading. The LCD also shows information for each of the OX-04's operating modes.

Control Buttons

Two control buttons, AIR and POWER MODE, are located below the LCD.

Table 3: OX-04 Control Button Functions

Button	Function(s)
AIR	<ul style="list-style-type: none">• turns on LCD backlight• resets alarm condition if LATCH is set to ON in Maintenance Mode• enters User Mode, Maintenance Mode, and Gas Select Mode when used with POWER MODE• activates the demand zero function (adjusts the OX-04's fresh air reading)• changes the value of a parameter available for adjustment• scrolls through parameter options
POWER MODE	<ul style="list-style-type: none">• turns the OX-04 on and off• turns on LCD backlight• enters and scrolls through Display Mode• enters instructions into the OX-04's microprocessor• resets alarm condition if LATCH is set to ON in Maintenance Mode• enters User Mode, Maintenance Mode, and Gas Select Mode when used with AIR

Alarm LED

The alarm LED above the sensor and buzzer openings alerts you to gas, low battery, and failure alarms.

Buzzer

One solid-state electronic buzzer is located inside the case. Sound exits the case through a hole in the upper left corner of the front case. The buzzer sounds for gas alarms, malfunctions, and low battery voltage. It also provides feedback for button presses and while in Display, User, Maintenance, or Gas Select Mode.

Vibrator

A vibrating motor inside the OX-04 case vibrates for gas alarms and unit malfunctions.

NOTE: If **STEALTH** is set to **ON**, the vibrator only functions when **VIB** in the **STEALTH** Gas Select Mode item is set to **ON** (see page 94).

Sensor

The O₂ sensor is an electrochemical cell that consists of two precious metal electrodes in a dilute acid electrolyte. A gas permeable membrane covers the sensor face and allows gas to diffuse into the electrolyte. The gas reacts in the sensor and produces a current proportional to the concentration of the target gas. The OX-04's circuitry amplifies the current, converts the current to a gas concentration, and displays the concentration on the LCD.

Hydrophobic Filter

The white, circular hydrophobic filter fits into a recessed area in the front case and is held in place by the sensor gasket. It prevents water and particulates from entering the instrument.

Infrared Communications Port

An infrared (IR) communications port is located at the top of the instrument, near the LED. Logged data transmits through the port in standard IrDA protocol. A computer's infrared port or an IrDA/USB cable connected to a USB port can be used to download data to the 04 Series Datalogging Program. See the 04 Series Datalogging Program operator's manual for data logging and downloading instructions.

Batteries

2 AAA batteries (alkaline or Ni-MH) power the OX-04. At 25°C alkaline batteries will last at least 3,000 hours (125 days) and Ni-MH batteries will last at least 2,000 hours (80 days). The battery icon in the upper right of the LCD shows remaining battery life.

A low battery warning activates when the OX-04 detects a low battery voltage. The OX-04 sounds a dead battery alarm when battery voltage is too low for Measuring Mode.

WARNING: *Use only Duracell MN2400 or PC2400 or Eneloop BK-4MCC batteries to maintain the QPS classification of the OX-04. Use of other batteries will void the QPS classification and may void the warranty. Do not mix old/new or different types of batteries.*

AVERTISSEMENT: *Utiliser uniquement des piles Duracell MN 2400 ou PC 2400 ou Eneloop BK-4MCC de maintenir la classification QPS de la OX-04. L'utilisation d'autres piles annule la classification QPS et peut annuler la garantie. Ne mélangez pas les anciennes/nouvelles ou différents types de piles.*

WARNING: *To prevent ignition of a hazardous atmosphere, the batteries must only be changed in an area known to be nonhazardous.*

AVERTISSEMENT: *Pour éviter l'inflammation d'une atmosphère dangereuse, la batterie ne doit être remplacée que dans une zone non dangereuse.*

Standard Accessories

Alligator Clip

An alligator clip installs to 2 spring bars on the rear case. Use the alligator clip to attach the OX-04 to clothing or a belt. Teeth in the alligator clip's jaws prevent slipping. The alligator clip can be rotated to change the instrument's orientation.

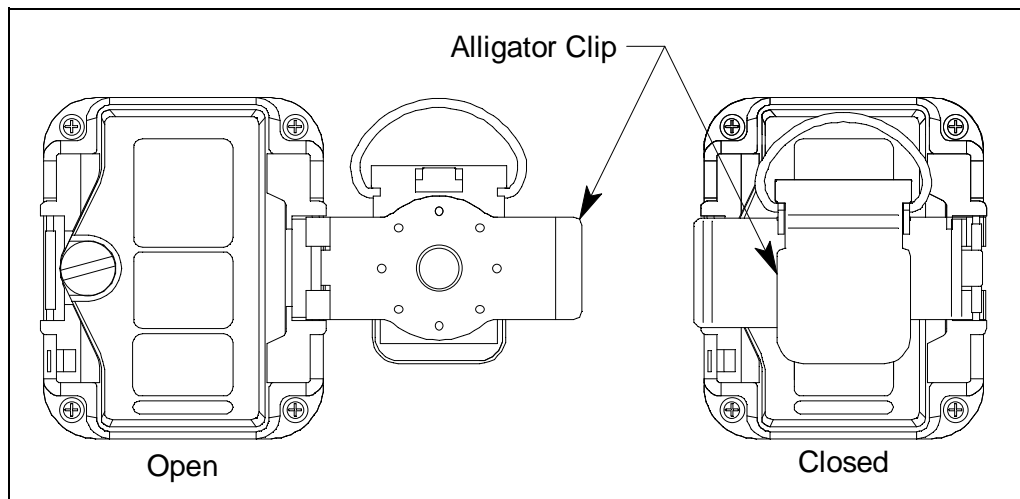

Figure 2: Alligator Clip

Protective Rubber Boot

A protective rubber boot is installed over the OX-04.

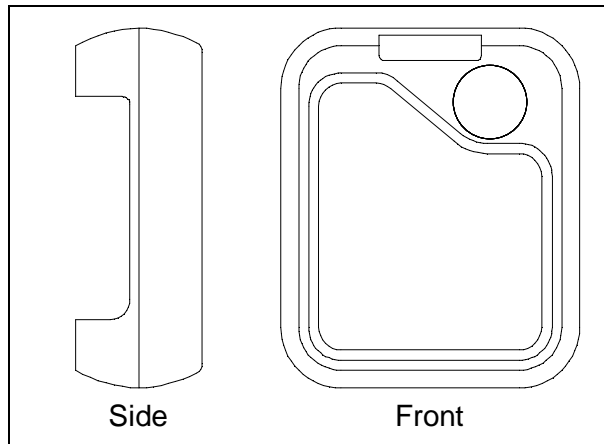

Figure 3: Rubber Boot

Optional Accessories

Belt Clip

The belt clip installs to 2 spring bars on the rear case and is used to easily clip the OX-04 onto a belt.

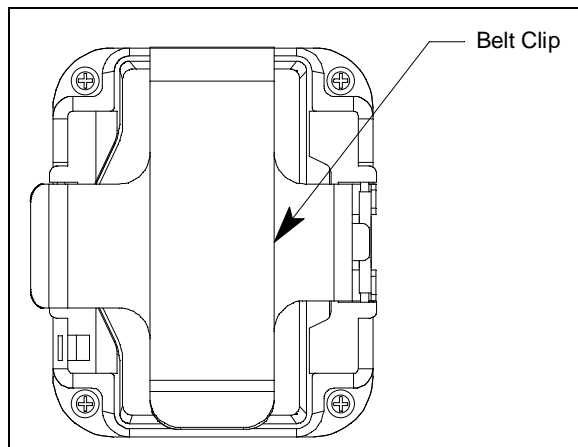

Figure 4: Belt Clip

Wrist Strap

The wrist strap connects to a feature on the back case.

Calibration Cup

The calibration cup installs over the sensor. You must use the calibration cup when performing a bump test, calibration, or gas test.

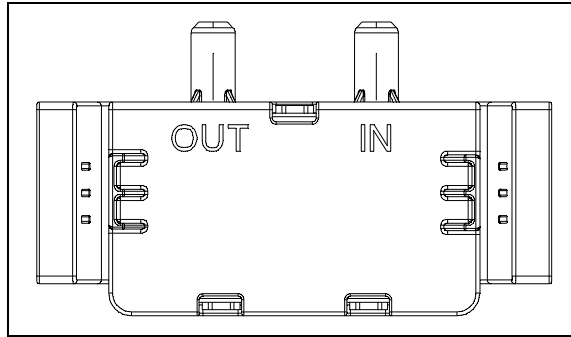

Figure 5: Calibration Cup

IrDA/USB Cable

Unless your computer has a built-in IrDA port, a IrDA/USB cable is needed to establish communication between the OX-04 and the Datalogging Program or the Setup Program.

Chapter 3: Measuring Mode

Overview

This chapter explains how to use the OX-04 to perform confined space entry monitoring or general area monitoring in Measuring Mode.

Start Up

This section explains how to start up the OX-04, get it ready for operation, and turn it off.

Turning On the OX-04

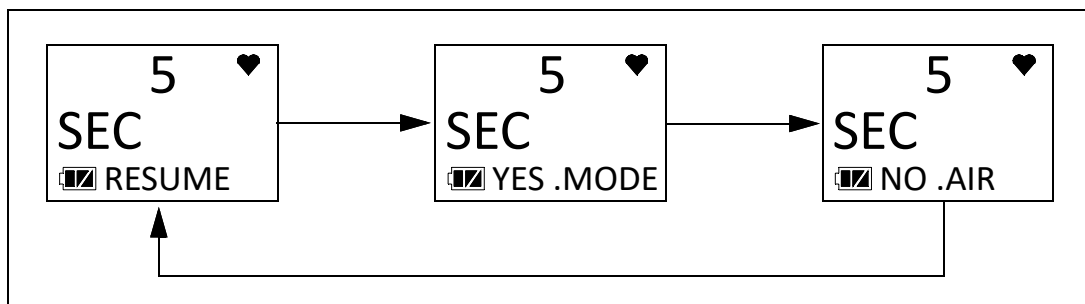

To illustrate certain functions, the following description of the OX-04 start up sequence assumes that the following items in User Mode are turned on: **LUNCH**, **CAL.RMDR**, **BP.RMDR** in User Mode, and **ID DISP** and **A.ZERO** in Maintenance Mode. If any of these items are turned off, then the corresponding screens do not appear.

1. Press and hold POWER MODE. Release the button when you hear a beep.
2. If **LUNCH** is set to **ON** (factory setting if **OFF**, see page 63), the Lunch Break Screen appears. The unit counts down from 5 seconds.

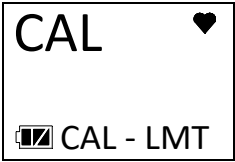

- a. Continue Accumulating: To continue accumulating peak readings from the last time the OX-04 was used, press and release POWER MODE or allow the countdown to reach 0. The short-term exposure limit (STEL) reading is reset each time the OX-04 is turned on.
- b. Reset Accumulation: To reset the accumulation of peak readings, press and release AIR before the countdown reaches 0.

3. If **CAL.RMDR** is set to **ON** (factory setting) and a calibration is due, the screen that appears next depends on how **CAL.EXPD** is set in User Mode (see page 55). The three possible screens are described below. If calibration is not due, the instrument displays the number of days left until a calibration is due.

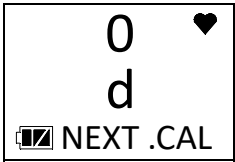
	CAL.EXPD set to CONFIRM (factory setting)	CAL.EXPD set to CANT.USE	CAL.EXPD set to NONE
LCD			
Sound	Buzzer sounds double pulsing tone	Buzzer sounds double pulsing tone	None
Action	<ul style="list-style-type: none"> • <u>Option A, Perform calibration</u>: Press and release POWER MODE to enter User Mode and perform a calibration. The instrument takes you straight to the calibration start screen in User Mode's GAS CAL/A-CAL(E-CAL) item (if Password Protection is set to On using the 04 Series Setup Program, you must enter a password first). See page 44 for calibration instructions. If the calibration is successful, the screen above will not appear again until the unit is due for calibration. If the calibration is not successful, the screen above will again appear in the startup sequence. • <u>Option B, Bypass message</u>: To continue without performing a calibration, press and release AIR. 	<p>The OX-04 cannot be used until a successful calibration is performed. Press and release POWER MODE to enter User Mode and perform a calibration. The instrument takes you straight to the calibration start screen in User Mode's GAS CAL/A-CAL (E-CAL) item (if Password Protection is set to On using the 04 Series Setup Program, you must enter a password first). If you don't press POWER MODE, the instrument automatically goes to the calibration start screen after 6 seconds (if Password Protection is set to On using the 04 Series Setup Program, you must enter a password first). See page 44 for calibration instructions.</p> <p>If the calibration is successful, the screen above will not appear again until the unit is due for calibration. If the calibration is not successful, the screen above will again appear in the startup sequence.</p>	<ul style="list-style-type: none"> • <u>Option A, Perform calibration</u>: If you want to enter User Mode and perform a calibration, press and release POWER MODE. The instrument takes you straight to the calibration start screen in User Mode's GAS CAL/A-CAL (E-CAL) item (if Password Protection is set to On using the 04 Series Setup Program, you must enter a password first). • <u>Option B, Bypass message</u>: To continue without performing a calibration, wait a few seconds for the instrument to continue with its startup sequence.

4. If **BP.RMDR** is set to **ON** (factory setting is **OFF**) and a bump test is due, the screen that appears next depends on how **BP.EXPD** is set in User Mode (see page 60). The three possible screens are described below. If a bump test is not due, the instrument displays the number of days left until a bump test is due.

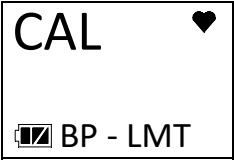
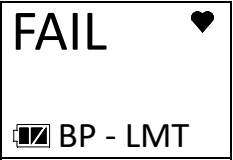
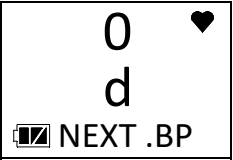
	BP.EXPD set to CONFIRM (factory setting)	BP.EXPD set to CANT.USE	BP.EXPD set to NONE
LCD			
Sound	Buzzer sounds double pulsing tone	Buzzer sounds double pulsing tone	None
Action	<ul style="list-style-type: none"> • <u>Option A, Perform bump test:</u> Press and release POWER MODE to enter User Mode and perform a bump test. The instrument takes you straight to the bump test start screen in User Mode's BUMP item (if Password Protection is set to On using the 04 Series Setup Program, you must enter a password first). See page 42 for bump test instructions. If the bump test is successful, the screen above will not appear again until the unit is due for bump testing. If the bump test is not successful, the screen above will again appear in the startup sequence. • <u>Option B, Bypass message:</u> To continue without performing a bump test, press and release AIR. 	<p>The OX-04 cannot be used until a successful bump test is performed. Press and release POWER MODE to enter User Mode and perform a bump test. The instrument takes you straight to the bump test start screen in User Mode's BUMP item (if Password Protection is set to On using the 04 Series Setup Program, you must enter a password first). If you don't press POWER MODE, the instrument automatically goes to the bump test start screen after 6 seconds (if Password Protection is set to On using the 04 Series Setup Program, you must enter a password first). See page 42 for bump test instructions.</p> <p>If the bump test is successful, the screen above will not appear again until the unit is due for bump testing. If the bump test is not successful, the screen above will again appear in the startup sequence.</p>	<ul style="list-style-type: none"> • <u>Option A, Perform bump test:</u> If you want to enter User Mode and perform a bump test, press and release POWER MODE. The instrument takes you straight to the bump test start screen in User Mode's BUMP item (if Password Protection is set to On using the 04 Series Setup Program, you must enter a password first). • <u>Option B, Bypass message:</u> To continue without performing a bump test, wait a few seconds for the instrument to continue with its startup sequence.

5. The Date/Time Screen appears for a few seconds.

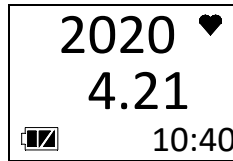

6. The Battery Voltage Screen appears for a few seconds. An “AL-L” at the bottom of the screen indicates that the alarms are set to latching. An “AL-A” at the bottom of the screen indicates that the alarms are set to auto reset. See page 84 for a description of how to change this parameter.

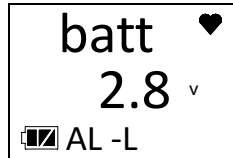

7. The following screens display for 1 second each: Gas Name, Full Scale, Warning Setpoint, Alarm Setpoint, and Alarm H Setpoint.

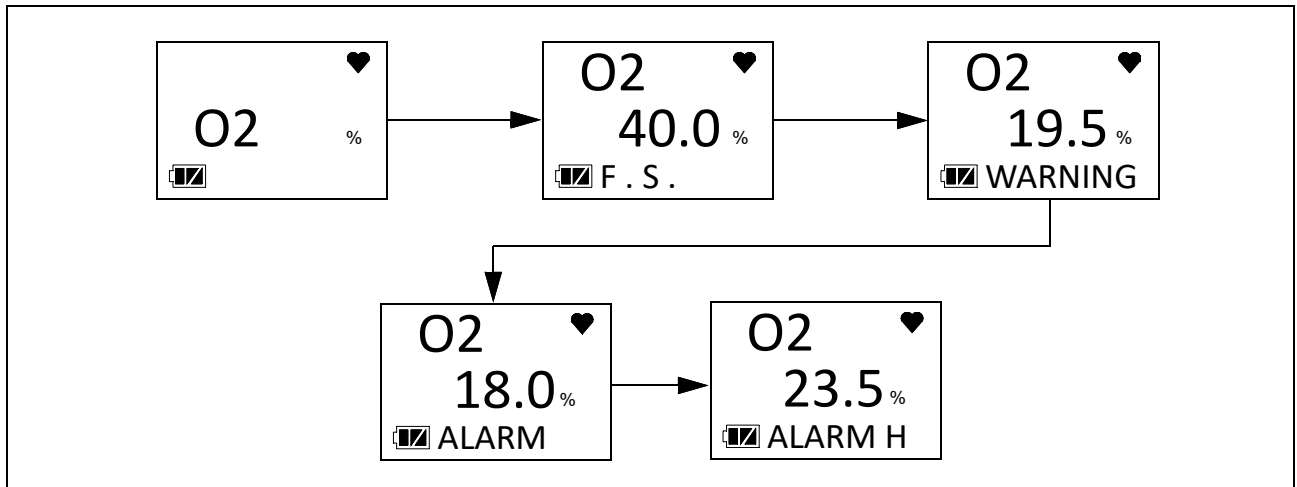

8. If **ID DISP** is set to **ON** (factory setting is **OFF**, see page 86), the User ID Screen appears for a few seconds, followed by the Station ID Screen.



9. If the OX-04 experiences a sensor failure during start up, a screen indicating that the sensor failed appears and the buzzer sounds a double pulsing tone once per second.

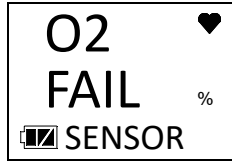

You cannot acknowledge the failure and continue to Measuring Mode. Replace the failed sensor as soon as possible.

10. If **A.ZERO** is set to **ON** (factory setting is **OFF**, see page 85), the instrument prompts you to do an auto zero. An auto zero operation sets the reading to 20.9% volume.

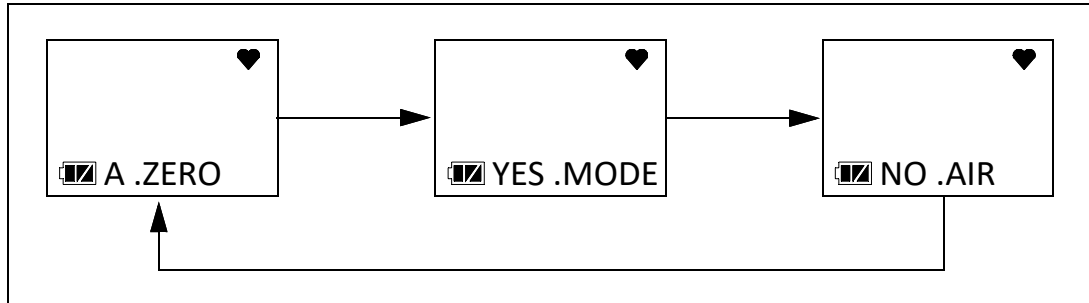

WARNING: *Make sure that the instrument is in a known fresh air environment (an environment free of combustible or toxic gases and of normal oxygen content, 20.9%) before performing an auto zero operation. If you perform an auto zero operation in an area with gases present, the adjustment will not be accurate.*

You must press and release the POWER MODE button to perform an auto zero function. If you do not press any key, after 15 seconds, the instrument enters Measuring Mode without performing an auto zero.

If **Password Protection** is turned **On** (factory setting is **Off**) using the 04 Series Setup Program, a user-set password is required to perform an auto zero. When the password screen appears, adjust each digit with the AIR button and press and release the POWER MODE button to move on to the next digit. Once the password is entered, the instrument performs the auto zero.

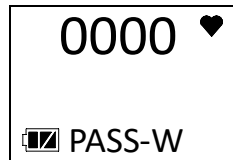

11. The OX-04 is now monitoring for gas in Measuring Mode. The Measuring Mode Screen displays the current gas reading.

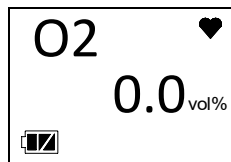

Performing a Demand Zero

Perform a demand zero before using the OX-04. This sets the reading to 20.9% volume.

1. Find a fresh-air environment. This is an environment free of toxic or combustible gases and of normal oxygen content (20.9%).
2. Turn on the unit as described above in Turning On the OX-04.
3. Press and hold AIR. The buzzer pulses and the LCD prompts you to continue holding AIR (if **KEY.TONE** is set to **ON** in User Mode).
4. Continue to hold AIR until the LCD prompts you to release it. The OX-04 sets the fresh air reading. Start up is complete and the unit is now ready for monitoring.

If **Password Protection** is turned **On** (factory setting is **Off**) using the 04 Series Setup Program, a user-set password is required to perform a demand zero. When the password screen appears, adjust each digit with the AIR button and press and release the POWER MODE button to move on to the next digit. Once the password is entered, the instrument sets the fresh air reading.

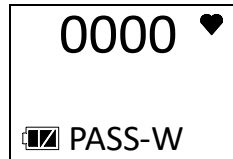

Turning Off the OX-04

1. Press and hold POWER MODE.
2. OFF appears on the display and the buzzer pulses for about five seconds (if **KEY.TONE** is set to **ON** in User Mode).
3. Release the button when OFF disappears from the display.

If **Password Protection** is turned **On** (factory setting is **Off**) using the 04 Series Setup Program, a user-set password is required to turn off the OX-04. When the password screen appears, adjust each digit with the AIR button and press and release the POWER MODE button to move on to the next digit. Once the password is entered, the instrument shuts off.

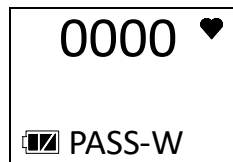

Measuring Mode Operation

When the OX-04 completes its startup sequence, it is in Measuring Mode. In Measuring Mode the OX-04 continuously monitors the sampled atmosphere and displays the gas concentration. The OX-04 is in Normal Operation if there are no alarm indicators.

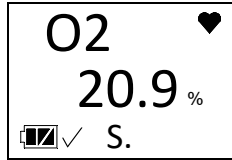

Heart Symbol: The heart symbol in the top right corner of the LCD indicates the operation status and flashes when normal. A microprocessor error causes the heart symbol to stop flashing or to disappear.

Check Mark: If **BP.RMDR** is set to **ON** and if a bump test is not due, a check mark appears in the lower left corner of the LCD.

“S”: If the instrument is operating in Stealth Mode, an “S.” appears at the bottom of the LCD.

Backlight: In a low-light environment, press and release either button to turn on the display backlight. See page 65 to program backlight duration.

Confirmation/Non-Compliance Indicator: If the **BEEP** item in User Mode is set to anything other than **OFF**, the OX-04 gives periodic indicators to confirm that it’s operating or to indicate a non-compliance (see page 63).

Monitoring an Area

1. Start up the OX-04 as described above in “Start Up” on page 17. It is now in Measuring Mode.

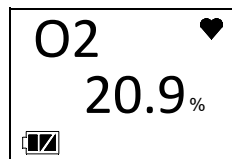

2. The instrument displays the O₂ reading.
3. Take the OX-04 to the monitoring area.
4. Wait at least 15 seconds.
5. If a reading is observed, allow the reading to stabilize to determine the gas concentration present.
6. If a gas alarm occurs, take appropriate action. See page 26.

Alarms

This section covers alarm indicators in Measuring Mode. It also describes how to reset the OX-04 after an alarm occurs and how to respond to an alarm condition.

NOTE: False alarms may be caused by radio frequency (RF) or electromagnetic (EMI) interference. Keep the OX-04 away from RF and EMI sources such as radio transmitters or large motors.

Alarm Indicators

The OX-04 buzzer sounds an alarm, the LED flashes, and the vibrator pulses when any sort of alarm condition or failure occurs. If the OX-04 is operating in Stealth Mode, the buzzer does not sound and the vibrator's operation depends on the **VIB** setting in Gas Select Mode's **STEALTH** item. See page 94 for more information.

NOTE: If an alarm condition occurs while you are in Display Mode, the OX-04 automatically returns to the Measuring Mode screen.

The table below summarizes the types of alarms produced by the OX-04 and their indicators.

Table 4: Alarm Types and Indicators

Alarm Type	Visual Indicators	Other Indicators
<u>Warning</u> Concentration of gas falls below the Warning setting.	<ul style="list-style-type: none">• Gas reading flashes• WARNING appears at the bottom of the LCD• Alarm LED flashes once per second• Backlight turns on	<ul style="list-style-type: none">• High-low tone sounds once per second• Vibrator pulses once per second
<u>Alarm</u> Concentration of gas falls below the Alarm setting.	<ul style="list-style-type: none">• Gas reading flashes• ALARM appears at the bottom of the LCD• Alarm LED flashes twice per second• Backlight turns on	<ul style="list-style-type: none">• High-low tone sounds twice per second• Vibrator pulses twice per second
<u>Alarm H</u> Concentration of gas rises above the Alarm H setting.	<ul style="list-style-type: none">• Gas reading flashes• ALARM H appears at the bottom of the LCD• Alarm LED flashes twice per second• Backlight turns on	<ul style="list-style-type: none">• High-low tone sounds twice per second• Vibrator pulses twice per second

Table 4: Alarm Types and Indicators

Alarm Type	Visual Indicators	Other Indicators
<u>Over Range</u>	<ul style="list-style-type: none"> Gas reading is replaced with a flashing □□□ Gas name and units flash OVER appears at the bottom of the LCD Alarm LED flashes twice per second Backlight turns on 	<ul style="list-style-type: none"> High-low tone sounds twice per second Vibrator pulses twice per second
<u>Minus Over Range</u>	<ul style="list-style-type: none"> Affected channel's gas reading is replaced with a flashing "- - -" Gas name and units flash MOVER appears at the bottom of the LCD Alarm LED flashes twice per second Backlight turns on 	<ul style="list-style-type: none"> High-low tone sounds twice per second Vibrator pulses twice per second
<u>Low Battery Warning</u>	<ul style="list-style-type: none"> The last bar in the battery icon starts flashing 	None
<u>Dead Battery Alarm</u>	<ul style="list-style-type: none"> Gas reading disappears. FAIL BATTERY appears on the LCD. Alarm LED flashes once per second 	Double pulsing tone sounds once per second
<u>Sensor Failure</u>	<ul style="list-style-type: none"> FAIL SENSOR appears on the LCD. Alarm LED flashes once per second 	Double pulsing tone sounds once per second
<u>Clock Failure</u>	<ul style="list-style-type: none"> FAIL 050 CLOCK appears on the LCD Alarm LED flashes once per second 	Double pulsing tone sounds once per second
<u>System Failure</u>	<ul style="list-style-type: none"> FAIL SYSTEM and an error code appear on the LCD Alarm LED flashes once per second 	Double pulsing tone sounds once per second

Responding to Alarms

This section describes response to gas, over range, battery, sensor failure, clock failure, and system failure alarms.

Responding to Gas Alarms

1. Follow your established procedure for an increasing gas condition.
2. Reset the alarm as necessary or allowed.
 - a. If **LATCH** is set to **ON** (factory setting) in Maintenance Mode, the gas reading must fall below an alarm setting before you can reset the alarm condition using **POWER MODE** or **AIR**.

If **Password Protection** is turned **On** (factory setting is **Off**) using the 04 Series Setup Program, you must press **POWER MODE** and **AIR** at the same time and then enter a user-set password to reset an alarm condition. When the password screen appears, adjust each digit with the **AIR** button and press and release the **POWER MODE** button to move on to the next digit. Once the password is entered, the alarm condition resets.

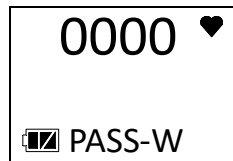

- b. If **LATCH** is set to **OFF** in Maintenance Mode, the alarm condition automatically resets when gas reading falls below an alarm setpoint.

Responding to Over Range Alarms

1. Follow your established procedure for an extreme gas condition.
2. Reset the alarm using **POWER MODE** or **AIR** once the alarm condition clears if **LATCH** is set to **ON** (factory setting) in Maintenance Mode.

If **Password Protection** is turned **On** (factory setting is **Off**) using the 04 Series Setup Program, you must press **POWER MODE** and **AIR** at the same time and then enter a user-set password to reset an alarm condition. When the password screen appears, adjust each digit with the **AIR** button and press and release the **POWER MODE** button to move on to the next digit. Once the password is entered, the alarm condition resets.

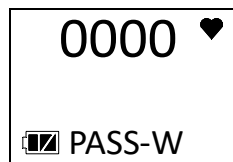

3. Calibrate the OX-04 as described on page 44.
4. If the over range condition continues or if you are not able to successfully calibrate the unit, you may need to replace the sensor.
5. If the over range condition continues after you replace the sensor, contact RKI Instruments, Inc. for further instructions.

Responding to Battery Alarms

WARNING: *The OX-04 is not operational as a gas monitoring device during a dead battery alarm. Take the OX-04 to a non-hazardous area and replace the batteries as described in “Replacing the Batteries (Alkaline or Ni-MH)” on page 71.*

The OX-04 is fully functional during a low battery warning. However, only a couple of days of operating time remain. The amount of time depends on LCD backlight use and alarm frequency. Replace the batteries as described on page 71 as soon as possible.

NOTE: Alarms and the LCD backlight consume battery power and reduce the amount of operating time remaining.

Responding to Sensor Failure Alarms

1. Calibrate the sensor as described on page 44.
2. If the sensor failure continues, replace the sensor as described on page 76.
3. If the sensor failure condition continues after replacing the sensor, contact RKI Instruments, Inc. for further instructions.

Responding to Clock Failure Alarms

A clock failure alarm occurs if the unit’s internal clock malfunctions.



1. Press and release POWER MODE to continue into Measuring Mode.

CAUTION: *There is no datalogging function if you operate the instrument after a clock failure.*

2. Attempt to set the date using the **DATE** item in User Mode (see page 67).
3. If the date cannot be set correctly, contact RKI Instruments, Inc. as soon as possible.

Responding to System Failure Alarms

1. If a system failure occurs, the system failure screen displays an error code as shown below:



2. The error code meanings are shown in the table below:

Table 5: Error Code Explanation

Error Code	Explanation
000	ROM failure
010	RAM failure
020	FRAM failure
031	FLASH memory failure
082	Temperature sensor failure

3. If the error code is anything but 031, the instrument cannot be used. Contact RKI Instruments, Inc. as soon as possible.

If the error code is 031, press and release POWER MODE to continue into Measuring Mode if the instrument must be used temporarily.

CAUTION: *There is no datalogging function if you operate the instrument after a 031 system failure. Contact RKI Instruments, Inc. as soon as possible.*

Data Logging

The OX-04 logs Measuring Mode gas readings, alarm data, and calibration data to its internal memory. Logged data can be download it to a computer via the infrared communications port on the front of the unit.

The data logging capacity depends on how often the OX-04 stores data and how often the OX-04 is turned on and off. The table below illustrates how much data logging time is available for the various interval times. It assumes that the unit is only turned on once and there are no alarms. The data logging interval time must be set using the 04 Series Datalogging Program.

Table 6: Data Logging Capacity

Interval Time	Data Logging Capacity
10 seconds	10 hours
20 seconds	20 hours
30 seconds	30 hours
1 minute	60 hours
3 minutes	180 hours
5 minutes	300 hours
10 minutes	600 hours

To utilize the OX-04's downloading capability, you need:

- PC with Windows 7, Windows 8, or Windows 10
- IrDA port or IrDA/USB cable (cable available from RKI Instruments, Inc.)
- 04 Series Datalogging Program (available at www.rkiinstruments.com/04series).

For a complete description of the Datalogging Program and procedures for downloading data to a computer, see the 04 Series Datalogging Program Operator's Manual.

Chapter 4: Display Mode

This section describes Display Mode which is accessible from Measuring Mode. See Table 7 below for a list of Display Mode's menu items, a short description of each item, and the page number for further description.

Table 7: Display Mode Menu Items

Display Mode Menu Item	Description
PEAK (page 31)	Displays the Peak (lowest) reading.
USER ID (page 31) ^A	View and/or change the User ID.
STN ID (page 32) ^A	View and/or change the Station ID.
CAL.DATA (page 33) ^B	Displays the last calibration date.
BP.DATA (page 34) ^C	Displays the last bump test date.
DATE (page 34)	Displays the current date and time.
TEMP (page 34)	Displays the current temperature.
ALARM--P (page 35)	View alarm points.
BUZZ.VOL (page 36) ^D	Set the buzzer volume to LO or HI (factory setting).
^A Only appears if DISP.SET is set to ON in User Mode (factory setting) <u>and</u> if ID DISP is set to ON in Maintenance Mode (factory setting is OFF).	
^B Only appears if CAL.RMDR is set to ON in User Mode (factory setting).	
^C Only appears if BP.RMDR is set to ON in User Mode (factory setting is OFF).	
^D Only appears if DISP.SET is set to ON in User Mode (factory setting).	

Tips for Using Display Mode

- To enter Display Mode and scroll from one item to the next or skip an item when a question is asked, press and release POWER MODE.
- To enter an item, press and release AIR.
- To change a flashing parameter, press and release AIR. To reverse the movement in a list (ie. from down to up or vice versa):
 - a. Press and hold AIR.
 - b. Immediately press POWER MODE and then release both buttons.
- To exit from an entered-information screen and go back to Measuring Mode, press and release POWER MODE until you get to the Measuring Mode screen.

NOTE: Each screen displays for 20 seconds. If you do not press a button within 20 seconds, the OX-04 automatically returns to Measuring Mode.

Peak Screen (PEAK)

The peak screen displays the lowest concentration detected since the OX-04 was turned on. The peak reading is stored until a lower level is detected, the peak reading is cleared, or the OX-04 is turned off.

The lunch break feature enables the OX-04 to save the peak reading when it is turned off so it can continue with the same peak when it is turned on again (see page 17).

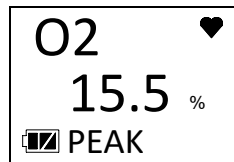

To clear the peak reading, do the following:

NOTE: If **Password Protection** is set to **On** using the 04 Series Setup Program, the peak reading cannot be cleared.

1. After entering Display Mode, press and release POWER MODE until **PEAK** appears.
2. Press and hold AIR until the screen prompts you to release it.

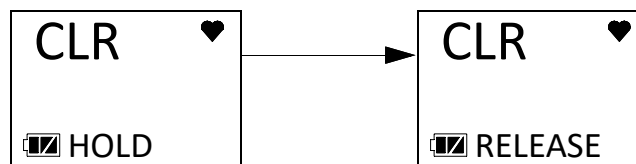

3. The peak reading is reset and the unit returns to the Peak Screen.

If you do not want to clear the peak reading, release AIR before the above screen sequence occurs. The unit returns to the Peak Screen.

Changing the User ID (USER ID)

This screen only appears if **DISP.SET** in User Mode is set to **ON** (factory setting) and if **ID DISP** in Maintenance Mode is set to **ON** (factory setting is **OFF**).

Use this screen to select a user ID from the 128 user IDs that are stored in the OX-04's memory. Before a user ID is selected on a brand new instrument, the user ID is "-----". The factory-installed user IDs have a "U_ID_XXX" format.

The user ID provides a way to identify the OX-04 user during a data logging session.

User IDs can only be selected in this menu item. In order to edit the 128 user IDs, you must use the 04 Series Datalogging Program or 04 Series Setup Program.

1. After entering Display Mode, press and release POWER MODE until the **USER ID** screen sequence appears.

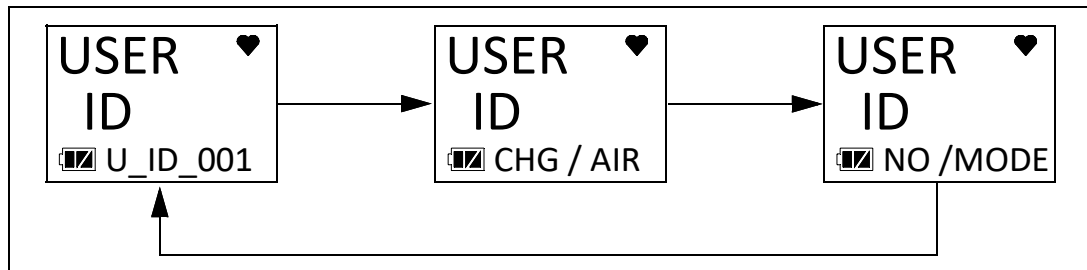

2. To change the User ID, press and release AIR. The current User ID flashes.

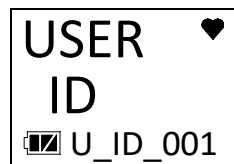

3. Use AIR to scroll to the desired User ID.
4. Press and release POWER MODE to save the User ID and return to the **USER ID** screen in Display Mode.

Changing the Station ID (STN ID)

This screen only appears if **DISP.SET** in User Mode is set to **ON** (factory setting) and if **ID DISP** in Maintenance Mode is set to **ON** (factory setting is **OFF**).

Use this screen to select a station ID from the 128 station IDs that are stored in the OX-04's memory. Before a station ID is selected on a brand new instrument, the station ID is "-----". The factory-installed station IDs have a "S_ID_XXX" format.

The station ID provides a way to identify the OX-04 location during a data logging session.

User IDs can only be selected in this menu item. In order to edit the 128 user IDs, you must use the 04 Series Datalogging Program or 04 Series Setup Program.

1. After entering Display Mode, press and release POWER MODE until the **STN ID** screen sequence appears.

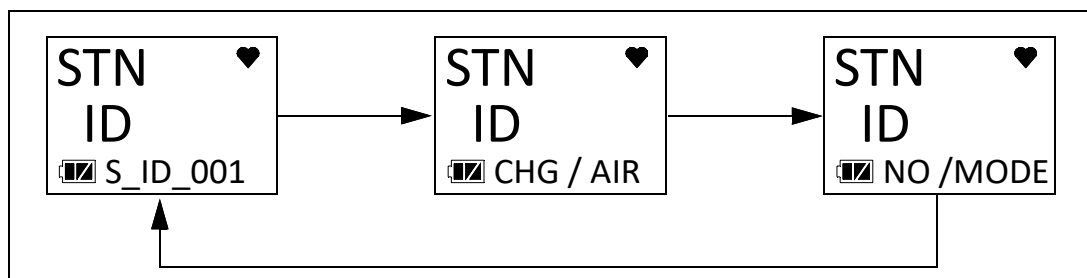

2. To change the Station ID, press and release AIR. The current Station ID flashes.

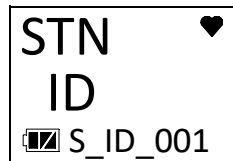

3. Use AIR to scroll to the desired Station ID.
4. Press and release POWER MODE to save the Station ID and return to the **STN ID** screen in Display Mode.

Last Successful Calibration Date (CAL.DATA)

The **CAL.DATA** screen shows the date of the last successful calibration. This screen only appears if **CAL.RMDR** is set to **ON** (factory setting).

1. After entering Display Mode, press and release POWER MODE until the **CAL.DATA** screen sequence appears.

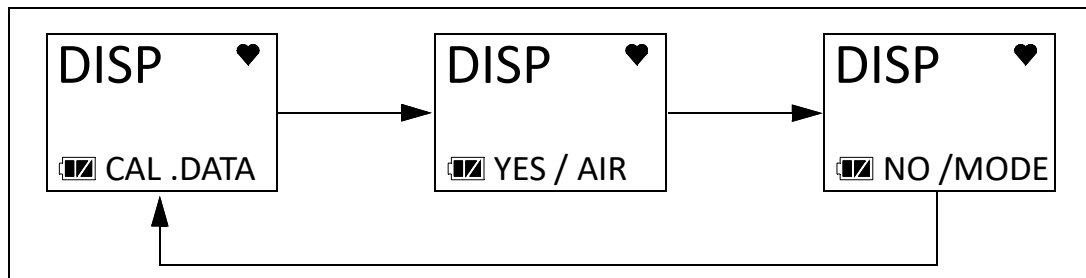

2. Press AIR to enter the **CAL.DATA** screen. The date of the last successful calibration displays.

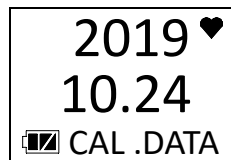

3. Press and release POWER MODE to return to the **CAL.DATA** screen in Display Mode.

Last Successful Bump Test Date (BP.DATA)

The **BP.DATA** screen shows the date of the last successful bump test. This screen only appears if **BP.RMDR** is set to **ON** (factory setting is **OFF**).

1. After entering Display Mode, press and release **POWER MODE** until the **BP.DATA** screen sequence appears.

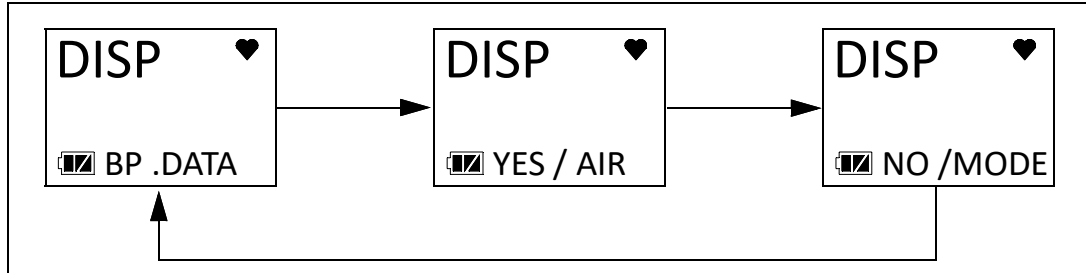

2. Press **AIR** to enter the **BP.DATA** screen. The date of the last successful bump test displays.

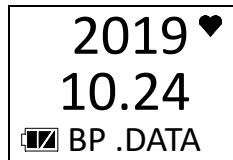

3. When you are done viewing the last bump test date, press and release **POWER MODE** to return to the **BP.DATA** screen in Display Mode.

Date/Time Screen (DATE)

The **DATE** screen shows the instrument's date and time.

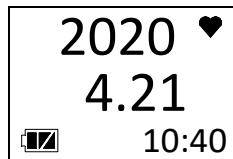

Temperature Screen (TEMP)

The **TEMP** screen shows the surrounding area's temperature.

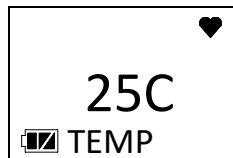

Alarm Points Screen (ALARM--P)

The Alarm Points Screen shows the gas alarm settings.

1. After entering Display Mode, press and release POWER MODE until the **ALARM--P** screen sequence appears.

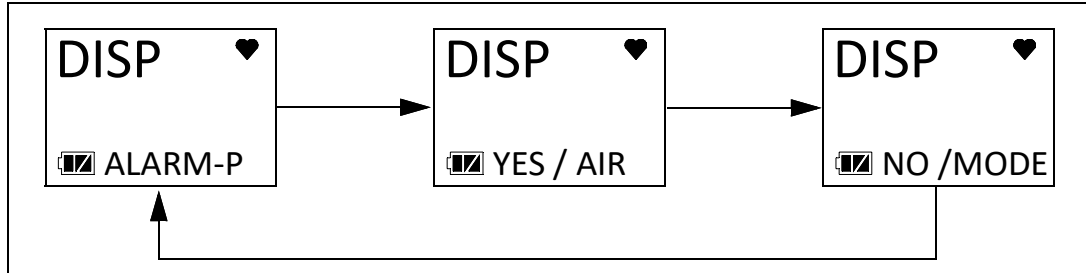

2. Press and release AIR. The Full Scale Setting screen appears.
3. Use AIR to scroll through the Warning, Alarm, and Alarm H.

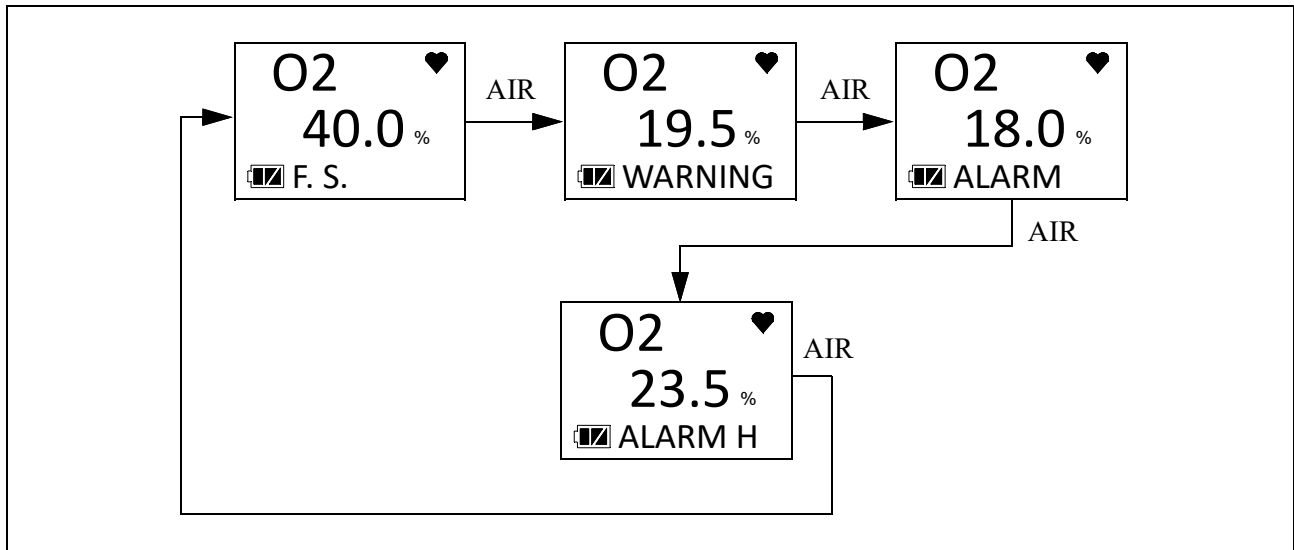

4. While viewing the alarm settings for a particular alarm point, press and release AIR and POWER MODE at the same time to simulate the alarm conditions. The buzzer will sound, the LED will flash, and the instrument will vibrate just as it would if the displayed condition was actually happening.
5. Press and release POWER MODE to return to the Alarm Points Screen.

Adjusting the Buzzer Volume (BUZZ.VOL)

The **BUZZ.VOL** screen allows you to adjust the volume of the instrument's buzzer. This screen only appears if **DISP.SET** in User Mode is set to **ON** (factory setting).

HI (factory setting): Buzzer volume is high.

LO: Buzzer volume is low.

1. While in Display Mode, press and release **POWER MODE** until **BUZZ.VOL** appears. The current setting displays on the top line.

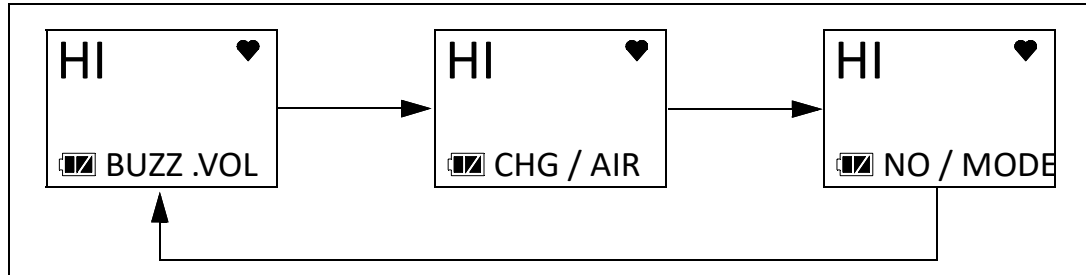

2. Press and release **AIR**. The current setting flashes.
3. Use **AIR** to display the desired setting.
4. Press and release **POWER MODE** to save the setting and return to the **BUZZ.VOL** item in Display Mode.

Chapter 5: User Mode and Calibration

Overview

This section describes the OX-04 in User Mode. See Table 8 below for a list of the items found in User Mode, the page that the item's instructions can be found on, and a short description of the item.

Table 8: User Mode Menu Items

User Mode Menu Item	Description			
BUMP (page 42)	Perform a bump test.			
	BUMP	Perform a bump test.		
	START	Begin the warmup sequence and enter Measuring Mode.		
	ESCAPE	Return to the BUMP menu item.		
GAS CAL (page 44)	Perform a fresh air adjustment, perform a span adjustment, change the calibration gas concentration.			
	AIR (page 46)	Perform a fresh air adjustment.		
	A-CAL (page 47) or E-CAL (page 50) depending on E-CAL User Mode setting*	A-CAL (or E-CAL)	Perform a span adjustment.	
		START	Begin the warmup sequence and enter Measuring Mode.	
		CAL-P	Set the calibration gas concentration.	
		ESCAPE	Return to the A-CAL item in the GAS CAL menu.	
	ESCAPE	Return to the GAS CAL item in User Mode.		
CAL SET (page 54)	Change parameters related to calibration.			
	CAL.RMDR (page 54)	<p>ON (factory setting): The instrument notifies the user upon startup when a calibration is due. Notification type depends on CAL.EXPD setting below. CAL.DATA screen appears in Display Mode.</p> <p>OFF: No notification upon startup when a calibration is due. CAL.DATA screen does not appear in Display Mode.</p>		

Table 8: User Mode Menu Items

User Mode Menu Item	Description		
CAL SET (page 54) (cont'd)	CAL.INT (page 55)	How often the instrument needs to be calibrated. Options: 1 - 1000 days (factory setting is 90 days)	
	CAL.EXPD (page 55)	Defines what action must be taken if a calibration is due upon startup. CONFIRM (factory setting): Press and release AIR to acknowledge that calibration is due and continue to Measuring Mode. CANT.USE : Cannot enter Measuring Mode until a successful calibration is performed. NONE : A screen indicates that calibration is due but warmup sequence continues.	
	ESCAPE	Return to the CAL SET item in User Mode.	
BUMP.SET (page 56)	Change parameters related to bump testing.		
	SETTING (page 56)	GAS.TIME	How long gas is applied during a bump test. Choices: 30 (factory setting), 45, 60, 90 seconds
		CHECK	Percentage of calibration gas concentration that the bump test reading must be within in order to pass bump. Options: 10%, 20%, 30%, 40%, 50% (factory setting)
		CAL.TIME	How long gas is applied during a calibration. GAS.TIME is deducted from this time. Options: 90 (factory setting) or 120 seconds
		A-CAL	ON (factory setting): If a bump test fails, a calibration automatically starts. OFF : If a bump test fails, a calibration does not automatically start.
		ESCAPE	Return to the SETTING item in the BUMP SET menu.
	BP.RMDR (page 59)	ON : The instrument notifies the user upon startup when a bump test is due. Notification type depends on BP.EXPD setting below. BP.DATA screen appears in Display Mode. OFF (factory setting): No notification upon startup when a bump test is due. BP.DATA screen does not appear in Display Mode.	
BP.INT (page 59)	How often the instrument needs to be bump tested. Options: 0 - 30 days (factory setting is 30 days)		

Table 8: User Mode Menu Items

User Mode Menu Item	Description	
BUMP.SET (page 56) (cont'd)	BP.EXPD (page 60)	<p>Defines what action must be taken if a bump test is due upon startup.</p> <p>CONFIRM (factory setting): Press and release AIR to acknowledge that bump test is due and continue to Measuring Mode.</p> <p>CANT.USE: Cannot enter Measuring Mode until a successful bump test is performed.</p> <p>NONE: A screen indicates that bump test is due but warmup sequence continues.</p>
	ESCAPE	Return to the BUMP SET item in User Mode.
ALARM-P (page 61)	Set alarm points (WARNING, ALARM, and ALARM H) and/or reset all alarms to their default settings.	
LUNCH (page 63)	<p>ON: Lunch break feature is on. Instrument asks if you want to resume PEAK readings at startup.</p> <p>OFF (factory setting): Lunch break feature is off. Instrument resets PEAK readings every time it's turned on.</p>	
BEEP (page 63)	Set confirmation beep parameters.	
	BEEP.SEL (page 64)	<p>LED: LED flashes and instrument vibrates based on interval defined in BEEP.INT to confirm instrument is still operating.</p> <p>BUZZER: Buzzer sounds and instrument vibrates based on interval defined in BEEP.INT to confirm instrument is still operating.</p> <p>LED+BUZ: LED flashes, buzzer sounds, and instrument vibrates based on interval defined in BEEP.INT to confirm instrument is still operating.</p> <p>BMP/CAL: LED flashes based on interval defined in BEEP.INT if bump test or calibration is due regardless of whether BP.RMDR and/or CAL.RMDR are set to ON.</p> <p>OFF (factory setting): No alerts to confirm instrument is still operating or that a bump test or calibration is due.</p>
	BEEP.INT (page 64)	<p>Confirmation alert interval. Confirmation type defined in BEEP.SEL.</p> <p>Options: 0.5 minute and 1 to 99 minutes in 1 minute increments. The factory setting is 5 minutes.</p>
	ESCAPE	Return to the BEEP item in User Mode.
BL TIME (page 65)	<p>How long the back light stays on after the last button press.</p> <p>Options: 0 - 255 seconds or OFF. The factory setting is 30 seconds.</p>	
KEY.TONE (page 65)	<p>ON (factory setting): Buzzer sounds when button is pressed.</p> <p>OFF: Buzzer does not sound when button is pressed.</p>	

Table 8: User Mode Menu Items

User Mode Menu Item	Description
DISP.SET (page 66)	OFF: USER ID, STN ID, and BUZZ.VOL items do not appear in Display Mode. ON (factory setting): BUZZ.VOL item appears in Display Mode. USER ID and STN ID items appear if ID DISP in Maintenance Mode is also set to ON.
ZERO.SUP (page 66)**	ON (factory setting): Not intended for field adjustment. The suppression value is 0.5% volume.
ZERO.FLW (page 66)***	ON (factory setting): Not intended for field adjustment.
E-CAL (page 67)	XX seconds: E-CAL appears in GAS CAL instead of A-CAL. OFF (factory setting): E-CAL does not appear in GAS CAL.
DATE (page 67)	Set the instrument's date and time.
PASS-W (page 68)	ON: User Mode is password-protected. Factory-set password is 0405 . OFF (factory setting): User Mode is not password-protected.
ROM/SUM (page 69)	View the firmware information for the OX-04's sensor board and main board.
START (page 69)	Press and release POWER MODE to begin the warmup sequence and enter Measuring Mode.
<p>* If a CYL SEL screen appears in A-CAL/E-CAL, CYL.DISP is set to ON in Maintenance Mode.</p> <p>** Only appears if ZSUP.DSP is set to ON in Maintenance Mode.</p> <p>*** Only appears if ZFLW.DSP is set to ON in Maintenance Mode.</p>	

Entering User Mode

WARNING: The OX-04 is not in operation as a gas detector while in User Mode.

1. Take the OX-04 to a non-hazardous location and turn it off if it is on.
2. Press and hold AIR, then press and hold POWER MODE. When you hear a beep, release the buttons.
3. The screen that appears depends on the setting of User Mode's **PASS-W** item.
If **PASS-W** is set to **OFF** (factory setting), continue with Step 6.
If **PASS-W** is set to **ON**, continue with Step 4.

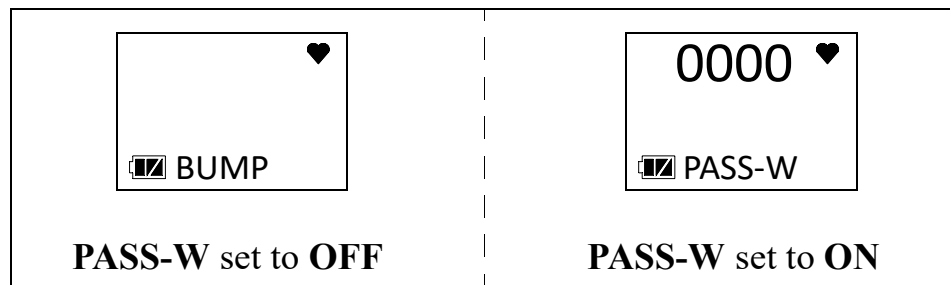

4. If **PASS-W** is set to **ON** in User Mode, a password screen appears and the first digit flashes. The factory-set password is **0405** but it can be changed.
5. Use **AIR** to select each password number then press **POWER MODE** to save it and move on to the next number. To go back a number, press and hold **AIR** and **POWER MODE** for a few seconds. To reverse the direction of change (ie. from increasing to decreasing or vice versa):
 - a. Press and hold **AIR**.
 - b. Immediately press **POWER MODE** and then release both buttons.
6. The **BUMP** item displays.

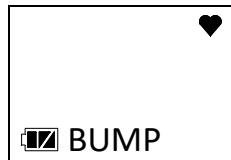

7. Use **AIR** to move through the User Mode items.

Tips for Using User Mode

- To scroll from one item to the next, press and release **AIR**. To reverse the scrolling direction:
 - a. Press and hold **AIR**.
 - b. Immediately press **POWER MODE** and then release both buttons.
 - c. The scrolling direction returns to the original direction when you exit and reenter a menu.
- To skip an item when a question is asked, press and release **AIR**.
- To enter an item and to save any changes, press and release **POWER MODE**.
- To change a flashing parameter, press and release **AIR**. To reverse the direction of change (ie. from increasing to decreasing or vice versa):
 - a. Press and hold **AIR**.
 - b. Immediately press **POWER MODE** and then release both buttons.
- To exit an entered item without saving a change, press and hold **AIR** and **POWER MODE** for a few seconds.

Performing a Bump Test (BUMP)

Bump test the instrument before each day's use with a known concentration of the target gas. The instrument does not need to be calibrated unless it does not pass the bump test.

To bump test the OX-04, you need:

- Calibration gas cylinder

Table 9: Calibration Concentration Limits

Channel	Min. Cal. Concentration	Max. Cal. Concentration
Oxygen (O ₂)	0.0%	18.0%

- 0.25 LPM fixed flow regulator
 - Non-absorbent tubing
 - Calibration cup
1. Confirm that the OX-04's calibration gas value matches the concentration listed on the calibration gas cylinder as described on page 53.
 2. Confirm that the regulator knob is turned all the way clockwise. Screw the 0.25 LPM fixed flow regulator onto the calibration cylinder.
 3. Install the calibration cup onto the OX-04. Be sure the calibration cup is installed in the correct direction and that it is pushed on all the way.

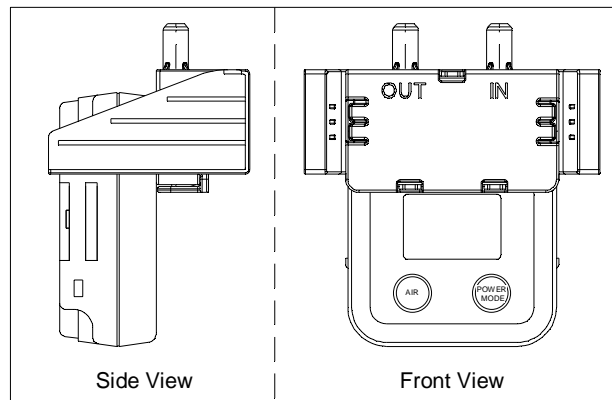

4. Use the tubing to connect the regulator to the inlet of the calibration cup (labeled "IN").
5. While in User Mode, press AIR to scroll to **BUMP**.



- Press and release POWER MODE. The display shows the calibration value (see page 53 if the calibration value does not match the calibration gas cylinder's concentration).

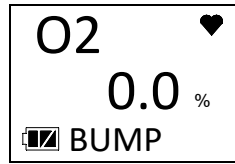

- Turn the regulator knob counterclockwise to open the regulator.
- Press and release POWER MODE.
- The gas reading flashes, the bottom of the screen alternates between “APLY” and “BUMP”, and the bottom of the screen counts down from the time set in **BUMP.SET\SETTING\GAS.TIME**.

To back out of the gas application screen without performing the bump test, press and release AIR and POWER MODE together.

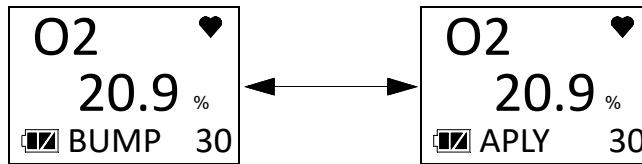

- At the end of the countdown, the instrument analyzes the results. Follow the flow chart to determine the bump test outcome.

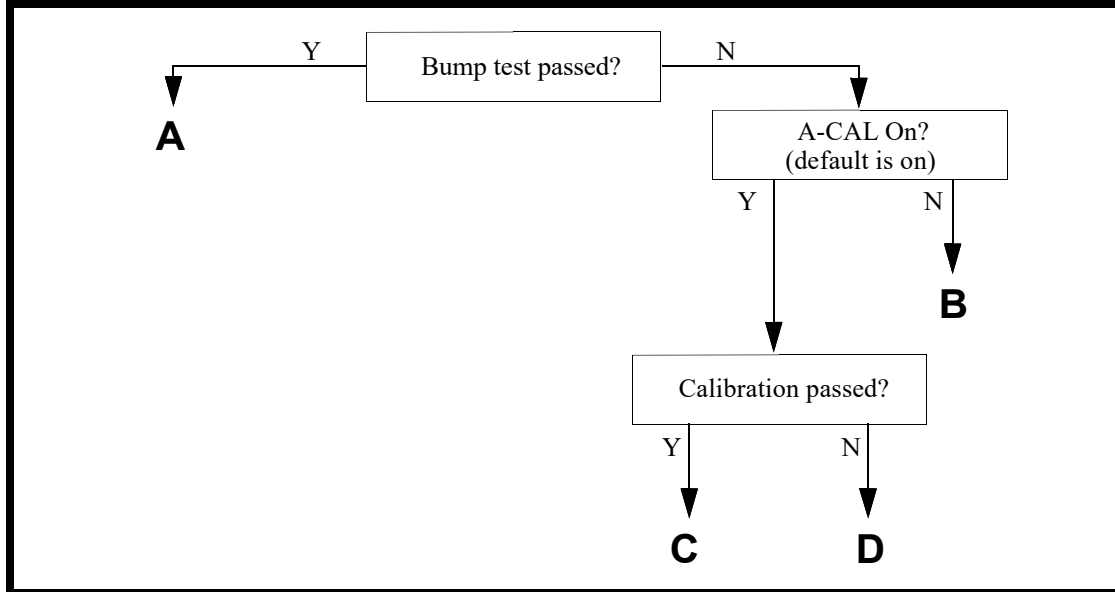
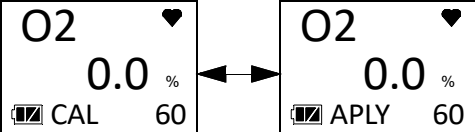
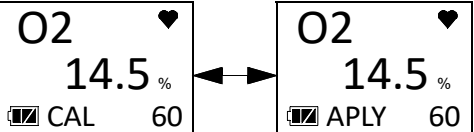
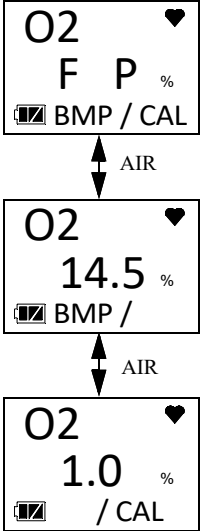
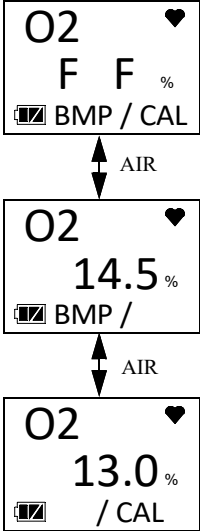

Figure 6: Bump Test Flow Chart

Option A from Flow Chart	Option B from Flow Chart
<ul style="list-style-type: none"> Bump test passed 	<ul style="list-style-type: none"> Bump test failed A-CAL set to OFF (factory setting is ON)
<p>1. The instrument indicates that the channel passed the bump test. Use AIR to scroll between the bump test result and the bump test gas reading.</p> <div data-bbox="324 531 799 667" style="border: 1px solid black; padding: 5px; margin: 10px 0;"> </div> <ol style="list-style-type: none"> Close the regulator. Unscrew the regulator. Remove the calibration cup. Press and release POWER MODE to return to the BUMP screen in the BUMP menu. Use AIR to scroll to START and press and release POWER MODE to enter Measuring Mode. 	<p>1. The instrument shows if the channel passed or failed the bump test. The LED flashes and the buzzer sounds. Use AIR to scroll between the result and the reading.</p> <div data-bbox="821 531 1295 667" style="border: 1px solid black; padding: 5px; margin: 10px 0;"> </div> <ol style="list-style-type: none"> Close the regulator. Unscrew the regulator. Remove the calibration cup. Press and release POWER MODE to return to the BUMP screen in the BUMP menu. Use AIR to scroll to START and press and release POWER MODE to enter Measuring Mode. Calibrate the OX-04 as soon as possible.

Option C from Flow Chart	Option D from Flow Chart
<ul style="list-style-type: none"> • Bump test failed • A-CAL set to ON (factory setting) • Calibration passed 	<ul style="list-style-type: none"> • Bump test failed • A-CAL set to ON (factory setting) • Calibration failed
<ol style="list-style-type: none"> 1. A calibration immediately and automatically starts. Continue to apply the calibration gas. 2. The calibration time is the difference between the GAS.TIME and the CAL.TIME values defined in the BUMP.SET\SETTING item in User Mode. 	<ol style="list-style-type: none"> 1. A calibration immediately and automatically starts. Continue to apply the calibration gas. 2. The calibration time is the difference between the GAS.TIME and the CAL.TIME values defined in the BUMP.SET\SETTING item in User Mode.
	
<ol style="list-style-type: none"> 3. The instrument shows the pass/fail results of the bump test/calibration. Use AIR to scroll between the results and the readings. 	<ol style="list-style-type: none"> 3. The instrument shows the pass/fail results of the bump test/calibration. The LED flashes and the buzzer sounds. Use AIR to scroll between the results and the readings.
	
<ol style="list-style-type: none"> 4. Close the regulator. 5. Unscrew the regulator. 6. Remove the calibration cup. 7. Press and release POWER MODE to return to the BUMP screen in the BUMP menu. 8. Use AIR to scroll to START and press and release POWER MODE to enter Measuring Mode. 	<ol style="list-style-type: none"> 4. Close the regulator. 5. Unscrew the regulator. 6. Remove the calibration cup. 7. Press and release POWER MODE to return to the BUMP screen in the BUMP menu. 8. Use AIR to scroll to START and press and release POWER MODE to enter Measuring Mode.

Performing a Calibration (GAS CAL)

- Bump test the instrument before each day's use with a known concentration of the target gas. A bump test can be done in User Mode's **BUMP** item or by applying gas in Measuring Mode. The instrument does not need to be calibrated unless it does not pass the User Mode bump test or does not respond appropriately, as defined by the user, in Measuring Mode.
- To fully calibrate the sensors, you must do a fresh air adjustment (**AIR CAL**) and a span adjustment (**A-CAL** or **E-CAL**).
- The OX-04 can be calibrated using either **A-CAL** or **E-CAL** depending on the setting of the **E-CAL** User Mode item.
- **A-CAL** (appears if **E-CAL** User Mode item is set to **OFF**): Apply gas for a period of time, then press and release **POWER MODE** to perform the adjustment.
- **E-CAL** (appears if **E-CAL** User Mode item is set to something besides **OFF**): As soon as gas is applied and the reading reaches 10% of the auto calibration value, the instrument counts down from the number of seconds specified in the **E-CAL** User Mode item and automatically performs the adjustment.

Performing a Fresh Air Adjustment (AIR)

1. Find a fresh air environment, an environment of normal oxygen content (20.9%) that is free of toxic and combustible gases.
2. While in User Mode, press **AIR** to scroll to **GAS CAL**.



3. Press and release **POWER MODE**. The **AIR** item appears.



4. Press and release **POWER MODE** to enter the **AIR** menu.

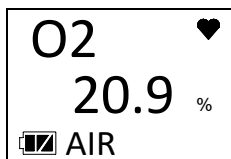

5. To return to the **AIR** menu without performing a fresh air adjustment, press and release **POWER MODE**.

- Press and hold **AIR** until the screen prompts you to release it.

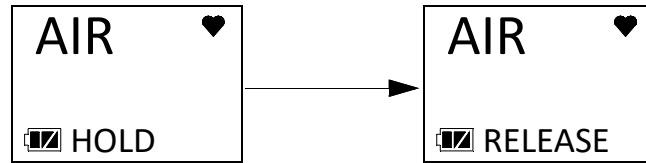

- If the fresh air adjustment passes, the instrument returns to the **AIR** item in the **GAS CAL** menu.
- If the fresh air adjustment fails, “FAIL AIR” displays. Press and release **POWER MODE** to acknowledge the failure. See page 70.

Performing a Span Adjustment in A-CAL

The **A-CAL** item only appears if **E-CAL** in User Mode is set to **OFF** (factory setting). If **E-CAL** is set to **ON**, see page 50 for calibration instructions.

Preparing for Span Adjustment

To adjust the span on the OX-04, you need:

- Calibration gas cylinder

Table 10: Calibration Concentration Limits

Channel	Min. Cal. Concentration	Max. Cal. Concentration
Oxygen (O ₂)	0.0%	18.0%

- 0.25 LPM fixed flow regulator
 - Non-absorbent tubing
 - Calibration cup
- Confirm that the OX-04’s calibration gas value matches the concentration listed on the calibration gas cylinder as described on page 53.
 - Confirm that the regulator knob is turned all the way clockwise. Screw the 0.25 LPM fixed flow regulator onto the calibration cylinder.
 - Install the calibration cup onto the OX-04. Be sure the calibration cup is installed in the correct direction and that it is pushed on all the way.

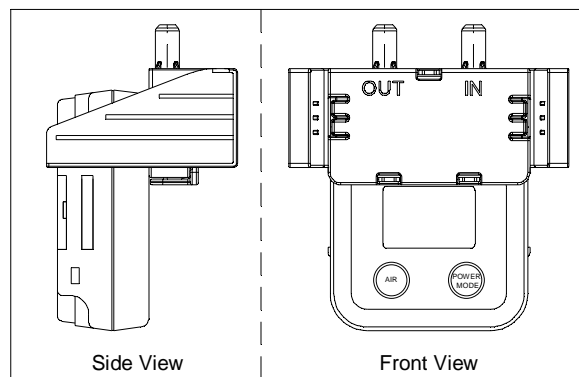

4. Use the tubing to connect the regulator to the inlet of the calibration cup (labeled “IN”).

Performing a Span Adjustment

1. While in User Mode, press AIR to scroll to **GAS CAL**.



2. Press and release POWER MODE. The **AIR** item appears.
3. Use AIR to scroll to the **A-CAL** item.



4. Press and release POWER MODE. The display shows the calibration value (see page 53 if the calibration value does not match the calibration gas cylinder’s concentration).

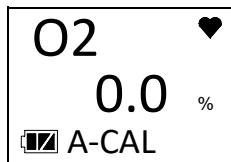

5. Press and release POWER MODE.
6. The gas reading flashes and the bottom of the screen alternates between “APPLY” and “A-CAL”.

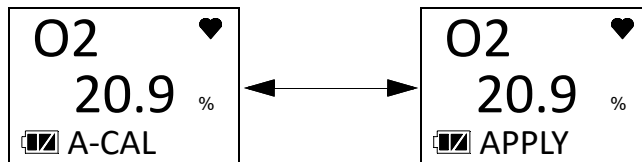

NOTE: To back out of the gas application screen without performing the calibration, press and release AIR and POWER MODE together.

7. Turn the regulator knob counterclockwise to open the regulator.
8. Allow the gas to flow for 1 minute.
9. Press and release POWER MODE.

10. The table below describes the 2 calibration outcomes.

Calibration Passed	Calibration Failed
<p>1. The instrument indicates that the calibration passed.</p> <div data-bbox="462 342 659 476" style="border: 1px solid black; padding: 5px; text-align: center;"> <p>PASS ♥</p> <p>▣ A-CAL</p> </div> <p>2. The instrument shows the current gas reading.</p> <div data-bbox="462 571 659 705" style="border: 1px solid black; padding: 5px; text-align: center;"> <p>O2 ♥</p> <p>1.5 %</p> <p>▣ A-CAL</p> </div> <p>3. If MAX.SPAN is set to ON (default is OFF, see page 93), the response reading's maximum adjustment is displayed. A maximum span of 24.0% volume indicates that the reading could have been adjusted up to 24.0% volume. If the maximum span value is close to the calibration gas value, the sensor should be replaced soon.</p> <p>The maximum adjustment is 25.0% volume.</p> <div data-bbox="462 1209 659 1344" style="border: 1px solid black; padding: 5px; text-align: center;"> <p>O2 ♥</p> <p>24.0 %</p> <p>▣ MAX .SPAN</p> </div> <p>4. Close the regulator.</p> <p>5. Remove the calibration cup.</p> <p>6. Press and release POWER MODE to enter Measuring Mode.</p>	<p>1. The instrument indicates that the calibration failed.</p> <div data-bbox="948 338 1144 472" style="border: 1px solid black; padding: 5px; text-align: center;"> <p>O2 ♥</p> <p>FAIL %</p> <p>▣ A-CAL</p> </div> <p>2. Close the regulator.</p> <p>3. Unscrew the regulator.</p> <p>4. Remove the calibration cup.</p> <p>5. Press and release POWER MODE to return to the A-CAL screen in the A-CAL menu.</p> <p>6. See “Troubleshooting” on page 70.</p>

Performing a Span Adjustment in E-CAL

The E-CAL item only appears if E-CAL in User Mode is set to **ON** (factory setting is **OFF**). If E-CAL is set to **OFF**, see page 47 for calibration instructions.

Preparing for Span Adjustment

To adjust the span on the OX-04, you need:

- Calibration gas cylinder

Table 11: Calibration Concentration Limits

Channel	Min. Cal. Concentration	Max. Cal. Concentration
Oxygen (O ₂)	0.0%	18.0%

- 0.25 LPM fixed flow regulator
 - Non-absorbent tubing
 - Calibration cup
1. Confirm that the OX-04's calibration gas value matches the concentration listed on the calibration gas cylinder as described on page 53.
 2. Confirm that the regulator knob is turned all the way clockwise. Screw the 0.25 LPM fixed flow regulator onto the calibration cylinder.
 3. Install the calibration cup onto the OX-04. Be sure the calibration cup is installed in the correct direction and that it is pushed on all the way.

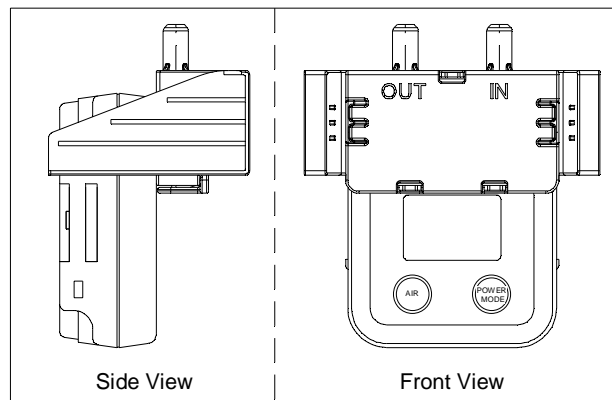

4. Use the tubing to connect the regulator to the inlet of the calibration cup (labeled “IN”).

Performing a Calibration

1. While in User Mode, press AIR to scroll to **GAS CAL**.



2. Press and release POWER MODE. The **AIR** item appears.
3. Use AIR to scroll to the **E-CAL** item.

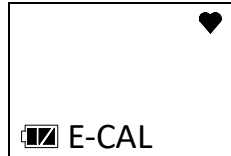

4. Press and release POWER MODE. The display shows the calibration value (see page 53 if the calibration value does not match the calibration gas cylinder's concentration).

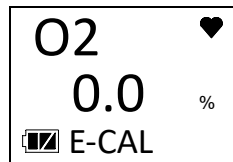

5. Press and release POWER MODE.
6. The gas reading flashes and the bottom of the screen says "GAS IN".

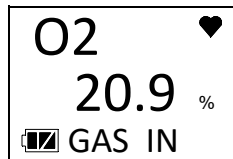

7. Turn the regulator knob counterclockwise to open the regulator.
8. Once the gas reading reaches 10% of the auto calibration value, the screen starts counting down from the time specified in the **E-CAL** User Mode item. In the example below, **E-CAL** is set to **60** seconds.

To back out of the gas application screen without performing the calibration, press and release AIR and POWER MODE together.

If the reading never reaches 10% of the auto calibration value, press and release POWER MODE to fail the calibration.

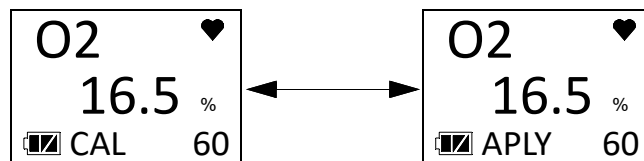

9. At the end of the countdown, the instrument makes the span adjustment.

10. The table below describes the 2 calibration outcomes.

Calibration Passed	Calibration Failed
<p>1. The instrument indicates that the calibration passed.</p> <div data-bbox="464 338 659 470" style="border: 1px solid black; padding: 5px; margin: 10px 0;"> <p style="text-align: center;">PASS ♥</p> <p style="text-align: center;">E-CAL</p> </div> <p>2. The instrument shows the current gas reading.</p> <div data-bbox="464 573 659 705" style="border: 1px solid black; padding: 5px; margin: 10px 0;"> <p style="text-align: center;">O2 ♥</p> <p style="text-align: center;">25.0 %</p> <p style="text-align: center;">E-CAL</p> </div> <p>3. If MAX.SPAN is set to ON (default is OFF, see page 93), the response reading's maximum adjustment is displayed. A maximum span of 24.0% volume indicates that the reading could have been adjusted up to 24.0% volume. If the maximum span value is close to the calibration gas value, the sensor should be replaced soon.</p> <p style="margin-left: 40px;">The maximum adjustment is 25.0% volume.</p> <div data-bbox="464 1228 659 1360" style="border: 1px solid black; padding: 5px; margin: 10px 0;"> <p style="text-align: center;">O2 ♥</p> <p style="text-align: center;">24.0 %</p> <p style="text-align: center;">MAX .SPAN</p> </div> <p>4. Close the regulator.</p> <p>5. Remove the calibration cup.</p> <p>6. Press and release POWER MODE to enter Measuring Mode.</p>	<p>1. The instrument indicates that the calibration failed.</p> <div data-bbox="951 331 1146 464" style="border: 1px solid black; padding: 5px; margin: 10px 0;"> <p style="text-align: center;">O2 ♥</p> <p style="text-align: center;">FAIL %</p> <p style="text-align: center;">E-CAL</p> </div> <p>2. Close the regulator.</p> <p>3. Unscrew the regulator.</p> <p>4. Remove the calibration cup.</p> <p>5. Press and release POWER MODE to return to the E-CAL screen in the E-CAL menu.</p> <p>6. See “Troubleshooting” on page 70.</p>

Setting the Calibration Values in CAL--P

1. While in User Mode, press AIR to scroll to GAS CAL.



2. Press and release POWER MODE. The AIR item appears.
3. Use AIR to scroll to the A-CAL item (E-CAL if E-CAL in User Mode is set to ON).



4. Press and release POWER MODE. The Auto Cal screen displays.

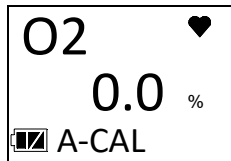

5. Use AIR to scroll to CAL--P.

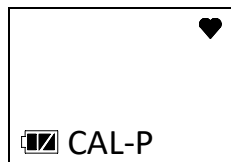

6. Press and release POWER MODE. The gas name displays.



7. Press and release POWER MODE. The calibration value begins to flash.

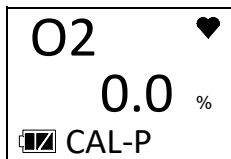

8. Use AIR to adjust the calibration gas value. The calibration gas value in the instrument must match the value listed on the calibration gas cylinder you are using.
9. Press and release POWER MODE to save the change. The calibration gas value stops flashing and the unit returns to the gas name screen.

10. Use AIR to scroll to **ESCAPE**.
11. Press and release POWER MODE to return to the **CAL--P** item in the **A-CAL** menu.
12. Press AIR to scroll to **ESCAPE**.
13. Press and release POWER MODE to return to the **A-CAL** item in the **GAS CAL** menu.
14. See “Exiting the GAS CAL Menu” on page 54 to return to User Mode.

Exiting the GAS CAL Menu

1. While in the **GAS CAL** menu, press AIR to scroll to **ESCAPE**.
2. Press and release POWER MODE to return to the **GAS CAL** item in User Mode.
3. See “Entering Measuring Mode (START)” on page 69 to enter Measuring Mode.

Setting Calibration Parameters (CAL SET)

The **CAL SET** menu has 4 items: **CAL.RMDR**, **CAL.INT**, **CAL.EXPD**, and **ESCAPE**.

1. While in User Mode, press AIR to scroll to **CAL SET**.



2. Press and release POWER MODE. The **CAL.RMDR** item appears.



CAL.RMDR

ON (factory setting): The OX-04 gives an indicator at start up if it is due for calibration. The type of indicator depends on the **CAL.EXPD** setting (see page 55).

OFF: The OX-04 does not give an indicator at start up if it is due for calibration.

1. After entering the **CAL SET** menu, press AIR to scroll to **CAL.RMDR**.



2. Press and release POWER MODE. The current setting flashes.

3. Use AIR to display the desired setting.
4. Press and release POWER MODE to save the setting and return to the **CAL.RMDR** item in the **CAL SET** menu.
5. See “Exiting the CAL SET Menu” on page 56 to return to User Mode.

CAL.INT

This setting defines the amount of time between calibrations and can be set in 1 day increments. The minimum setting is 1 day and the maximum setting is **1000** days. The factory setting is **90** days.

1. After entering the **CAL SET** menu, press AIR to scroll to **CAL.INT**.



2. Press and release POWER MODE. The current setting flashes.
3. Use AIR to display the desired setting.
4. Press and release POWER MODE to save the setting and return to the **CAL.INT** item in the **CAL SET** menu.
5. See “Exiting the CAL SET Menu” on page 56 to return to User Mode.

CAL.EXPD

This item defines what indicator is given during start up when calibration is due and **CAL.RMDR** is set to **ON** (factory setting).

CONFIRM (factory setting): The OX-04 gives an indicator at start up if calibration is past due. Press and release AIR to continue without calibrating or press and release POWER MODE to enter User Mode and perform a calibration.

CANT.USE: The OX-04 gives an indicator at start up that calibration is past due. Press and release POWER MODE to enter User Mode and perform a calibration. Pressing AIR has no effect. A successful calibration must be performed in order to use the instrument.

NONE: The OX-04 gives an indicator at startup that calibration is past due. It is not necessary to acknowledge the indicator. If desired, press POWER MODE to enter User Mode and perform a calibration. The warm-up sequence continues on its own.

1. After entering the **CAL SET** menu, press AIR to scroll to **CAL.EXPD**.



2. Press and release POWER MODE. The current setting flashes.
3. Use AIR to display the desired setting.
4. Press and release POWER MODE to save the setting and return to the **CAL.EXPD** item in the **CAL SET** menu.
5. See “Exiting the CAL SET Menu” on page 56 to return to User Mode.

Exiting the CAL SET Menu

1. While in the **CAL SET** menu, press AIR to scroll to **ESCAPE**.
2. Press and release POWER MODE to return to the **CAL SET** item in User Mode.
3. See “Entering Measuring Mode (START)” on page 69 to enter Measuring Mode.

Setting Bump Test Parameters (BUMP.SET)

The **BUMP.SET** menu has 5 items: **SETTING**, **BP.RMDR**, **BP.INT**, **BP.EXPD**, and **ESCAPE**.

1. While in User Mode, press AIR to scroll to **BUMP.SET**.



2. Press and release POWER MODE. The **SETTING** item appears.



SETTING

The **SETTING** menu has 5 items: **GAS.TIME**, **CHECK**, **CAL.TIME**, **A-CAL**, and **ESCAPE**.

1. After entering the **BUMP.SET** menu, press AIR to scroll to **SETTING**.



2. Press and release POWER MODE. The **GAS.TIME** item appears.

GAS.TIME

The **GAS.TIME** is the amount of time that the instrument is exposed to gas during a bump test. The available choices are **30** seconds (factory setting), **45** seconds, **60** seconds, and **90** seconds.

1. After entering the **SETTING** menu, press AIR to scroll to **GAS.TIME**.



2. Press and release POWER MODE. The current setting flashes.
3. Use AIR to display the desired setting.
4. Press and release POWER MODE to save the setting and return to the **GAS TIME** item in the **SETTING** menu.
5. See “Exiting the SETTING Menu” on page 58 to return to **BUMP.SET** menu.

CHECK

CHECK is the bump test tolerance value and is represented as a percentage of the calibration gas concentration. It is the percentage that the bump test reading can differ from the auto calibration value and still be considered a passed bump test. If the bump test reading differs more, the bump test fails. The available values are **10%**, **20%**, **30%**, **40%**, and **50%** (factory setting).

1. After entering the **SETTING** menu, press AIR to scroll to **CHECK**.

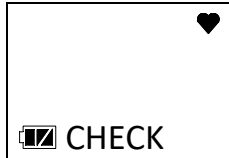

2. Press and release POWER MODE. The current setting flashes.
3. Use AIR to display the desired setting.
4. Press and release POWER MODE to save the setting and return to the **CHECK** item in the **SETTING** menu.
5. See “Exiting the SETTING Menu” on page 58 to return to **BUMP.SET** menu.

CAL.TIME

The **CAL.TIME** is the total time the instrument is exposed to calibration gas if **A-CAL** is set to **ON** and a bump test fails. The bump test time is deducted from the calibration time. For example, if the **CAL.TIME** is set to 90 seconds and the **GAS.TIME** is set to 30 seconds, if the bump test fails, the OX-04 is only exposed to gas for an additional 60 seconds. The available values are **90** seconds (factory setting), and **120** seconds.

1. After entering the **SETTING** menu, press AIR to scroll to **CAL.TIME**.



2. Press and release **POWER MODE**. The current setting flashes.
3. Use **AIR** to display the desired setting.
4. Press and release **POWER MODE** to save the setting and return to the **CAL.TIME** item in the **SETTING** menu.
5. See “Exiting the **SETTING** Menu” on page 58 to return to **BUMP.SET** menu.

A-CAL

ON (factory setting): If a bump test fails, the unit automatically begins a calibration.

OFF: If a bump test fails, the unit does not automatically begin a calibration.

1. After entering the **SETTING** menu, press AIR to scroll to **A-CAL**.



2. Press and release **POWER MODE**. The current setting flashes.
3. Use **AIR** to display the desired setting.
4. Press and release **POWER MODE** to save the setting and return to the **A-CAL** item in the **SETTING** menu.
5. See “Exiting the **SETTING** Menu” on page 58 to return to **BUMP.SET** menu.

Exiting the SETTING Menu

1. While in the **SETTING** menu, press **AIR** to scroll to **ESCAPE**.
2. Press and release **POWER MODE** to return to the **SETTING** item in the **BUMP.SET** menu.
3. See “Exiting the **BUMP.SET** Menu” on page 60 to return to User Mode.

BP.RMDR

ON: The OX-04 gives an indicator at start up if it is due for bump testing. The type of indicator depends on the **BP.EXPD** setting (see page 60). If the instrument is not due for bump testing, a check mark appears in the lower left corner of the LCD.

OFF (factory setting): The OX-04 does not give an indicator at start up if it is due for bump testing.

1. After entering the **BUMP.SET** menu, press AIR to scroll to **BP.RMDR**.



2. Press and release POWER MODE. The current setting flashes.
3. Use AIR to display the desired setting.
4. Press and release POWER MODE to save the setting and return to the **BP.RMDR** item in the **BUMP.SET** menu.
5. See “Exiting the BUMP.SET Menu” on page 60 to return to User Mode.

BP.INT

This setting defines the amount of time between bump tests and can be set in 1 day increments. The minimum setting is **0** days and the maximum setting is **30** days (factory setting).

1. After entering the **BUMP.SET** menu, press AIR to scroll to **BP.INT**.



2. Press and release POWER MODE. The current setting flashes.
3. Use AIR to display the desired setting.
4. Press and release POWER MODE to save the setting and return to the **BP.INT** item in the **BUMP.SET** menu.
5. See “Exiting the BUMP.SET Menu” on page 60 to return to User Mode.

BP.EXPD

This item defines what indicator is given during start up when a bump test is due and **BP.RMDR** is set to **ON** (factory setting is **OFF**).

CONFIRM (factory setting): The OX-04 gives an indicator at start up if a bump test is past due. Press and release AIR to continue without bump testing or press and release POWER MODE to enter User Mode and perform a bump test.

CANT.USE: The OX-04 gives an indicator at start up that a bump test is past due. Press and release POWER MODE to enter User Mode and perform a bump test. Pressing AIR has no effect. A successful bump test must be performed in order to use the instrument.

NONE: The OX-04 gives an indicator at startup that a bump test is past due. It is not necessary to acknowledge the indicator. If desired, press POWER MODE to enter User Mode and perform a bump test. The warm-up sequence continues on its own.

1. After entering the **BUMP.SET** menu, press AIR to scroll to **BP.EXPD**.



2. Press and release POWER MODE. The current setting flashes.
3. Use AIR to display the desired setting.
4. Press and release POWER MODE to save the setting and return to the **BP.EXPD** item in the **BUMP.SET** menu.
5. See “Exiting the BUMP.SET Menu” on page 60 to return to User Mode.

Exiting the BUMP.SET Menu

1. While in the **BUMP.SET** menu, press AIR to scroll to **ESCAPE**.
2. Press and release POWER MODE to return to the **BUMP.SET** item in User Mode.
3. See “Entering Measuring Mode (START)” on page 69 to enter Measuring Mode.

Alarm Settings (ALARM--P)

The **ALARM--P** menu has 3 items: **ALARM--P**, **DEF.ALMP**, and **ESCAPE**.

1. While in User Mode, press AIR to scroll to **ALARM--P**.



2. Press and release POWER MODE. The gas name displays.



Setting the Alarm Points

1. After entering the **ALARM-P** menu, press AIR to scroll to the gas name.

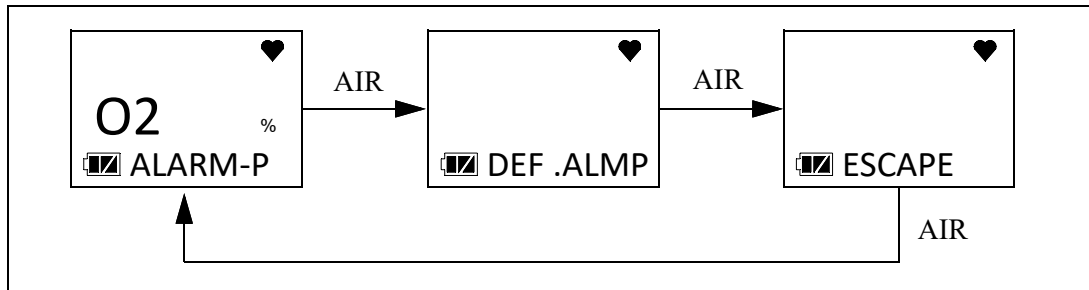

2. Press and release POWER MODE.
3. The Warning setpoint flashes.

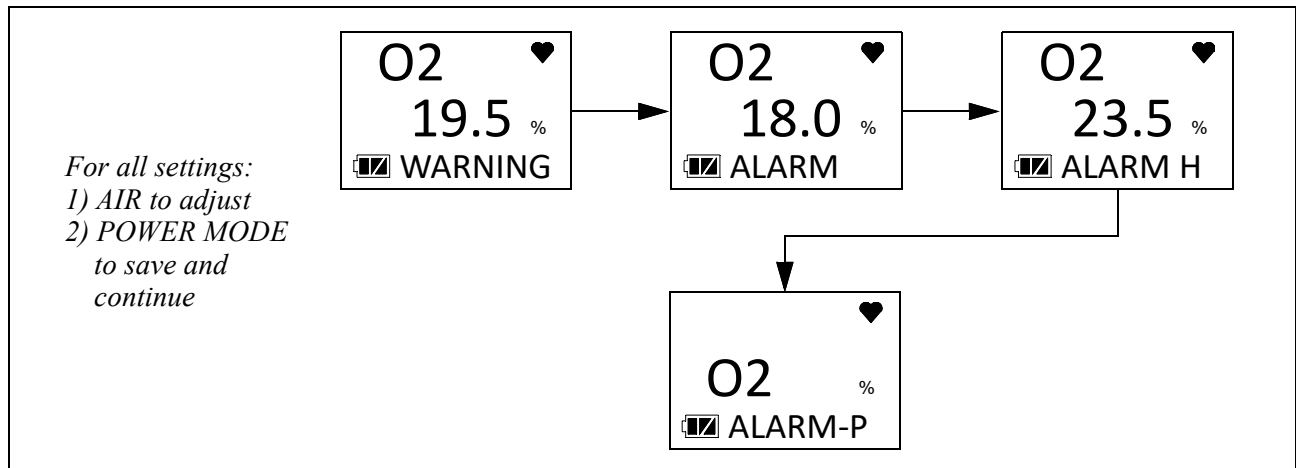

4. Use AIR to adjust the Warning setpoint. The alarm setpoint limitations are as follows:
 - $0.0\% \leq \text{ALARM} \leq \text{WARNING} \leq 20.0\%$
 - $21.8\% \leq \text{ALARM H} \leq 40.0\%$
5. Press and release POWER MODE to save the setting.
6. Repeat Step 4 and Step 5 for the Alarm and Alarm H settings.
7. The instrument returns to the gas name screen.
8. See “ESCAPE” on page 62 to return to User Mode.

Defaulting the Alarm Points

Defaulting the alarm points defaults them back to factory settings as outlined in Table 1 or to the settings saved in the **SAVE-AP** item in Gas Select Mode if you performed a **SAVE-AP** operation.

1. After entering the **ALARM-P** menu, press AIR to scroll to **DEF.ALMP**.



2. Press POWER MODE to enter the **DEF.ALMP** item.
3. Press POWER MODE to perform an alarm default. Press AIR to return to the **DEF.ALMP** item in the **ALARM-P** menu.
4. The instrument asks if you're sure you want to default the alarm points.
5. Press POWER MODE to default the alarm points. Press AIR to return to the **DEF.ALMP** item in the **ALARM-P** menu.
6. See “ESCAPE” on page 62 to return to User Mode.

ESCAPE

1. While in the **ALARM-P** menu, press AIR to scroll to **ESCAPE**.
2. Press and release POWER MODE to return to the **ALARM--P** item in User Mode.
3. See “Entering Measuring Mode (START)” on page 69 to enter Measuring Mode.

Updating the Lunch Break Setting (LUNCH)

OFF (factory setting): The OX-04 automatically starts a new PEAK reading collection and resets the time in operation at startup.

ON: The Lunch Break Screen displays during startup. From this screen, you can choose to continue accumulating PEAK readings and the time in operation from the last time the OX-04 was used or start collecting new readings and reset the time in operation.

1. While in User Mode, press AIR to scroll to **LUNCH**.



2. Press and release POWER MODE. The current setting flashes.
3. Use AIR to display the desired setting.
4. Press and release POWER MODE to save the setting and return to the **LUNCH** item in User Mode.
5. See “Entering Measuring Mode (START)” on page 69 to enter Measuring Mode.

Setting the Confirmation Beep and Non-Compliance Indicator (BEEP)

The **BEEP** menu has 3 items: **BEEP.SEL**, **BEEP.INT**, and **ESCAPE**.

1. While in User Mode, press AIR to scroll to **BEEP**.



2. Press and release POWER MODE. The **BEEP.SEL** item appears.



BEEP.SEL

BEEP.SEL defines what kind of confirmation or non-compliance indicator you want to occur in Measuring Mode. The available choices are:

OFF (factory setting): The OX-04 does not provide a confirmation alert or non-compliance indicator.

LED: The OX-04's LED double flashes as often as defined by the **BEEP.INT** parameter to verify that the instrument is operating.

BUZZER: The OX-04's buzzer double beeps as often as defined by the **BEEP.INT** parameter to verify that the instrument is operating.

LED+BUZ: The OX-04's LED double flashes and the buzzer double beeps as often as defined by the **BEEP.INT** parameter to verify that the instrument is operating.

BMP/CAL: If a bump test or a calibration is due and if **BP.EXPD** or **CAL.EXPD** is set to **CONFIRM** (factory setting) or **NONE**, the OX-04's LED double flashes as often as defined by the **BEEP.INT** parameter to indicate a non-compliance. Once a bump test or calibration (depending on which is due) is done, the LED stop flashing.

1. While in the **BEEP** menu, press AIR to scroll to **BEEP.SEL**.



2. Press and release POWER MODE. The current setting flashes.
3. Use AIR to display the desired setting.
4. Press and release POWER MODE to save the setting and return to the **BEEP.SEL** item in the **BEEP** menu.
5. See "ESCAPE" on page 65 to return to User Mode.

BEEP.INT

The **BEEP.INT** parameter defines how often the confirmation alert or non-compliance indicator selected in **BEEP.SEL** occurs. This setting only applies if the **BEEP.SEL** parameter is set to something other than **OFF** (factory setting). The available choices are **0.5** minutes and **1-99** minutes in 1 minute increments. The factory setting is **5** minutes.

1. While in the **BEEP** menu, press AIR to scroll to **BEEP.INT**.



2. Press and release POWER MODE. The current setting flashes.

3. Use AIR to display the desired setting.
4. Press and release POWER MODE to save the setting and return to the **BEEP.INT** item in the **BEEP** menu.
5. See “ESCAPE” on page 65 to return to User Mode.

ESCAPE

1. While in the **BEEP** menu, press AIR to scroll to **ESCAPE**.
2. Press and release POWER MODE to return to the **BEEP** item in User Mode.
3. See “Entering Measuring Mode (START)” on page 69 to enter Measuring Mode.

Updating the Backlight Time (BL TIME)

This setting defines how long the LCD backlight stays on when you press any button. The minimum setting is **OFF**; the maximum setting is **255** seconds. The factory setting is **30** seconds.

1. While in User Mode, press AIR to scroll to **BL TIME**.



2. Press and release POWER MODE. The current setting flashes.
3. Use AIR to display the desired setting.
4. Press and release POWER MODE to save the setting and return to the **BL TIME** item in User Mode.
5. See “Entering Measuring Mode (START)” on page 69 to enter Measuring Mode.

Turning the Key Tone On/Off (KEY.TONE)

ON (factory setting): The instrument beeps when a button is pressed.

OFF: The instrument does not beep when a button is pressed.

1. While in User Mode, press AIR to scroll to **KEY.TONE**.



2. Press and release POWER MODE. The current setting flashes.

3. Use AIR to display the desired setting.
4. Press and release POWER MODE to save the setting and return to the **KEY.TONE** item in User Mode.
5. See “Entering Measuring Mode (START)” on page 69 to enter Measuring Mode.

Display Mode Items (DISP.SET)

OFF: **USER ID**, **STN ID**, and **BUZZ.VOL** screens do not appear in Display Mode.

ON (factory setting): **BUZZ.VOL** screen appears in Display Mode. **USER ID** and **STN ID** screens appear in Display Mode if **ID DISP** in Maintenance Mode is also set to **ON** (factory setting is **OFF**).

1. While in User Mode, press AIR to scroll to **DISP.SET**.



2. Press and release POWER MODE. The current setting flashes.
3. Use AIR to display the desired setting.
4. Press and release POWER MODE to save the setting and return to the **DISP.SET** item in User Mode.
5. See “Entering Measuring Mode (START)” on page 69 to enter Measuring Mode.

Zero Suppression (ZERO.SUP)

This item only appears if **ZSUP.DSP** is set to **ON** in Maintenance Mode (factory setting is **OFF**).

The **ZERO.SUP** setting is not intended for field adjustment. The default setting is **ON**. The suppression value is 0.5% volume.

Zero Follower (ZERO.FLW)

This item only appears if **ZFLW.DSP** is set to **ON** in Maintenance Mode (factory setting is **OFF**).

The OX-04 does not support zero follower functionality. This menu item has no effect on instrument operation.

Turning Easy Calibration On/Off (E-CAL)

OFF (factory setting): Auto Calibration (A-CAL) item appears in GAS CAL menu instead of Easy Calibration (E-CAL).

XX seconds: Easy Calibration (E-CAL) item appears in GAS CAL menu instead of Auto Calibration (A-CAL). During a calibration, the instrument counts down from the number of seconds you select.

1. While in User Mode, press AIR to scroll to E-CAL.

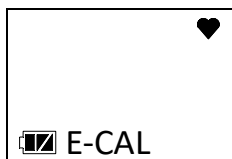

2. Press and release POWER MODE. The current setting flashes.
3. Use AIR to display the desired setting.
4. Press and release POWER MODE to save the setting and return to the E-CAL item in User Mode.
5. See “Entering Measuring Mode (START)” on page 69 to enter Measuring Mode.

Setting the Date/Time (DATE)

1. While in User Mode, place the cursor next to DATE.



2. Press and release POWER MODE. The date and time display with the year flashing.

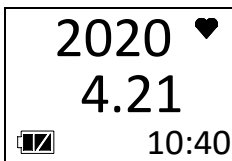

3. Use AIR to display the desired year.
4. Press and release POWER MODE to save the setting. The month setting flashes.
5. Repeat Step 3 and Step 4 to enter the month, day, hours, and minutes settings. The date and time are saved and the instrument returns to the DATE item in User Mode.
6. See “Entering Measuring Mode (START)” on page 69 to enter Measuring Mode.

Turning the Password On/Off (PASS-W)

ON: The OX-04 prompts you for a password when you enter User Mode. The factory-set password is **0405** but it can be changed.

OFF (factory setting): No password is required to enter User Mode.

1. While in User Mode, press AIR to scroll to **PASS-W**.

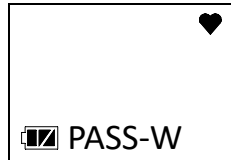

2. Press and release POWER MODE. The current setting flashes.
3. Use AIR to display the desired setting.
4. If you selected **OFF**, press and release POWER MODE to save the setting and return to the **PASS-W** item in User Mode.

If you selected **ON**, continue with Step 5.

5. Press and release POWER MODE. The Set Password Screen appears. The current password appears and the first digit flashes.

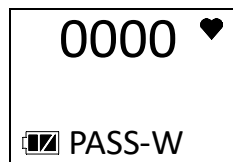

6. Use AIR to display a number from 0 to 9.
7. Press and release POWER MODE to enter the selection and advance to the next number. To go back a number, press and hold AIR and POWER MODE for a few seconds.
8. Repeat Step 6 and Step 7 to select the remaining numbers. When you press and release POWER MODE to enter the last number, the password is saved and the instrument returns to the **PASS-W** item in User Mode.
9. See “Entering Measuring Mode (START)” on page 69 to enter Measuring Mode.

Viewing the ROM/SUM (ROM/SUM)

The **ROM/SUM** screen shows the instrument's firmware version and firmware checksum.

1. While in User Mode, press AIR to scroll to **ROM/SUM**.

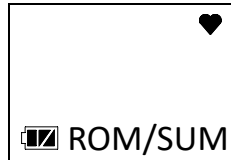

2. Press and release POWER MODE. The screen shows the ROM/SUM. The ROM is the top value and the SUM is the bottom value.

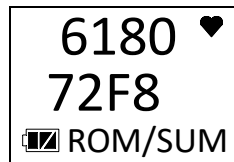

3. Press and release POWER MODE to return to the **ROM/SUM** item in User Mode.
4. See “Entering Measuring Mode (START)” on page 69 to enter Measuring Mode.

Entering Measuring Mode (START)

1. While in User Mode, press AIR to scroll to **START**.



2. Press and release POWER MODE. The instrument begins its warmup sequence.

Chapter 6: Maintenance

Overview

This chapter describes troubleshooting procedures for the OX-04. It also includes procedures for replacing the batteries and replacing various consumable parts.

WARNING: *RKI Instruments recommends that service, calibration, and repair of RKI gas detectors be performed by personnel properly trained for this work. Replacing the sensor and other parts with original equipment does not affect the intrinsic safety of the instrument.*

AVERTISSEMENT: *RKI Instruments recommande que le service, l'étalonnage et la réparation des détecteurs de gaz RKI soient effectués par du personnel dûment formé à ces travaux. Le remplacement du capteur et d'autres pièces par l'équipement d'origine n'affecte pas la sécurité intrinsèque de l'instrument.*

Troubleshooting

The troubleshooting table describes error messages, symptoms, probable causes, and recommended action for problems you may encounter with the OX-04.

Table 12: Troubleshooting the OX-04

Symptoms	Probable Causes	Recommended Action
<ul style="list-style-type: none">The LCD is blank.	<ul style="list-style-type: none">The unit got turned off.The batteries needs to be replaced.The battery cover may not be completely closed.	<ol style="list-style-type: none">To turn on the unit, press and briefly hold POWER MODE.Replace the batteries.Be sure the battery cover is completely closed and that the screw is tight.If the difficulties continue, contact RKI Instruments, Inc. for further instruction.
<ul style="list-style-type: none">The LCD shows an abnormally high reading but other gas detection instruments do not.	<ul style="list-style-type: none">The OX-04 needs to be recalibrated.The sensor needs replacement.	<ol style="list-style-type: none">Recalibrate the unit.If the difficulties continue, replace the sensor and calibrate.If the difficulties continue, contact RKI Instruments, Inc. for further instruction.

Table 12: Troubleshooting the OX-04

Symptoms	Probable Causes	Recommended Action
<ul style="list-style-type: none"> • Calibration fails. 	<ul style="list-style-type: none"> • The calibration value does not match the cylinder gas concentration. • The sample gas is not reaching the sensor because of a bad connection. • The calibration cylinder is out of gas or is outdated. • The sensor needs replacement. 	<ol style="list-style-type: none"> 1. Make sure the OX-04 has been properly set up for calibration. 2. Check all calibration tubing for leaks or for any bad connections. 3. Verify that the calibration cylinder contains an adequate supply of fresh test sample. 4. If the fail condition continues, replace the sensor. 5. If the difficulties continue, contact RKI Instruments, Inc. for further instruction.
<ul style="list-style-type: none"> • Heart symbol at the top of the screen becomes steadily on or disappears. 	<ul style="list-style-type: none"> • A microprocessor error has occurred. 	<ul style="list-style-type: none"> • Contact RKI Instruments, Inc. for further instruction.

Replacing the Batteries (Alkaline or Ni-MH)

WARNING: *To prevent ignition of a hazardous atmosphere, batteries must only be changed in an area known to be nonhazardous.*

AVERTISSEMENT: *Pour éviter l'inflammation d'une atmosphère dangereuse, la batterie ne doit être remplacée que dans une zone non dangereuse.*

WARNING: *Use only Duracell MN2400 or PC2400 or Eneloop BK-4MCC batteries to maintain the QPS classification of the OX-04. Use of other batteries will void the QPS classification and may void the warranty. Do not mix old/new or different types of batteries.*

AVERTISSEMENT: *Utiliser uniquement des piles Duracell MN 2400 ou PC 2400 ou Eneloop BK-4MCC de maintenir la classification QPS de la OX-04. L'utilisation d'autres piles annule la classification QPS et peut annuler la garantie. Ne mélangez pas les anciennes/nouvelles ou différents types de piles.*

Replace the batteries when the last bar in the battery icon is flashing.

1. Make sure the OX-04 is off.

2. Release the side of the alligator or belt clip that is opposite the hinge. You may need to use a screwdriver to pry it open.

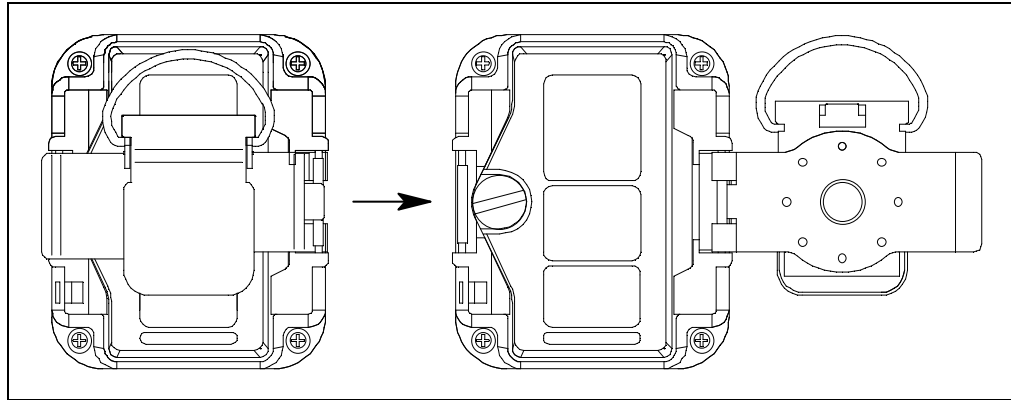

Figure 7: Releasing the Alligator or Belt Clip

3. Rotate the captive battery cover screw counterclockwise.

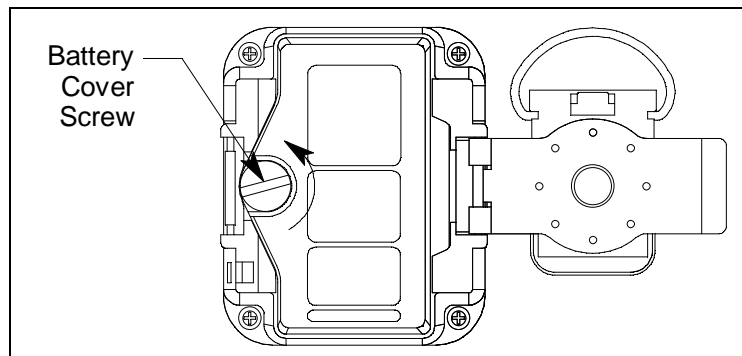

Figure 8: Unscrew Battery Cover Screw

4. Remove the battery cover.
5. Remove the old batteries.

NOTE: New batteries must be installed within 5 minutes to avoid having to reset the date/time.

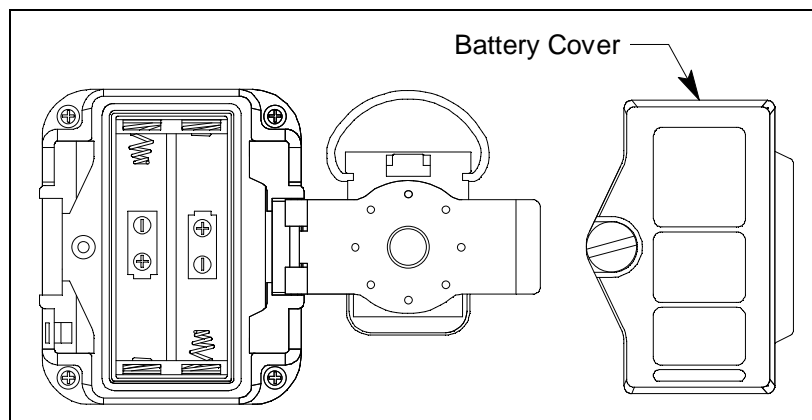

Figure 9: Battery Cover Removal

6. Install the new AAA batteries. Follow the diagram shown in the battery compartment.

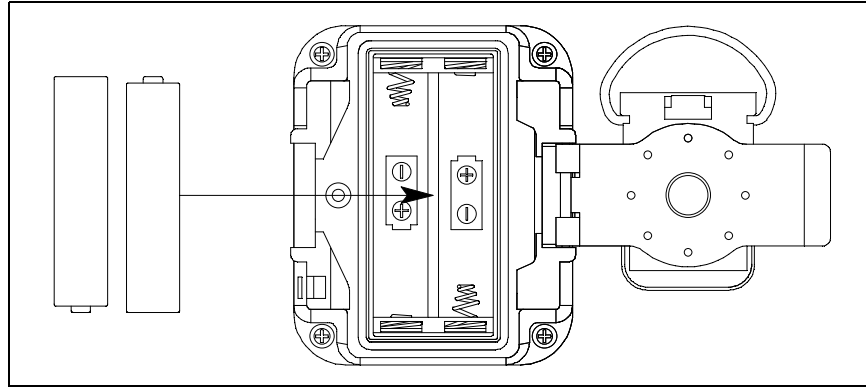

Figure 10: Installing New Batteries

7. Reinstall the battery cover and tighten the battery cover screw.
8. If the instrument has been without batteries for more than 5 minutes, the date and time are reset and need to be set again. When the new batteries are installed, the instrument automatically turns on and displays the Date/Time Screen. Set the date and time as described on page 67. Once the date and time are set, the instrument begins its warmup sequence. If you do not set the date and time within 30 seconds, the instrument automatically begins its warmup sequence.

Recharging the Batteries (Ni-MH Batteries Only)

Any battery charger capable of charging AAA Ni-MH batteries can be used to recharge the OX-04's Ni-MH batteries. RKI Instruments, Inc. recommends using one of the chargers specified on page 78.

WARNING: To prevent ignition of a hazardous atmosphere, batteries must only be charged in an area known to be nonhazardous.

1. Remove the batteries from the OX-04 as described in Step 1 - Step 5 on page 71.
2. Install the Ni-MH batteries in the charger. See the battery charger's manual for charging instructions.
3. Put the batteries back in the OX-04 and reinstall the battery cover.

Replacing the Hydrophobic Filter

1. Verify that the OX-04 is off.
2. Remove the rubber boot, if installed.
3. Use a small Phillips screwdriver to unscrew the 4 screws that attached the front case to the rear case.

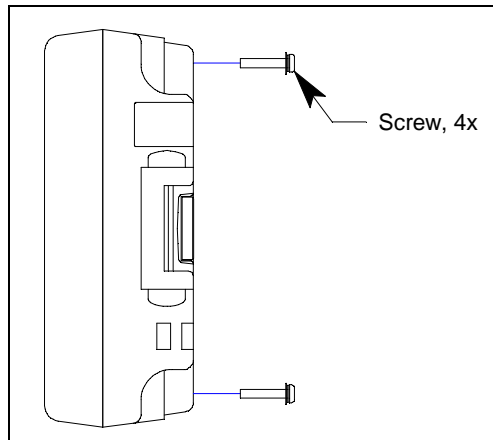

Figure 11: Unscrewing Case Screws

4. Turn the instrument right side up. The screws are not captive and may fall out. Be sure not to lose them.
5. Remove the front case from the rear case.

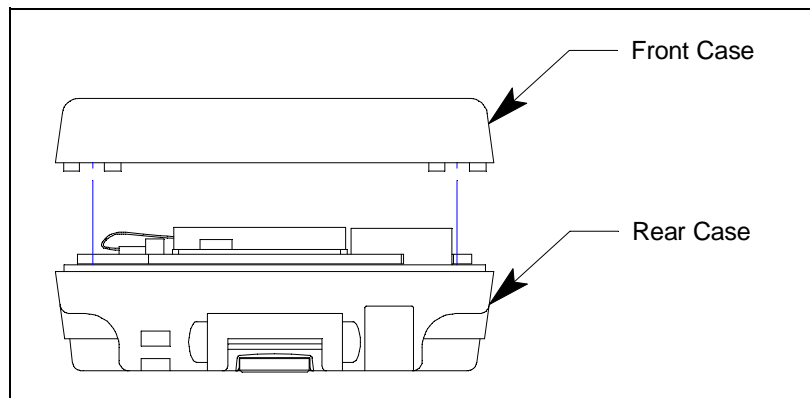

Figure 12: Case Separation

6. Turn the front case upside down.
7. If the sensor stayed in the front case, remove the sensor.

8. Remove the white hydrophobic filter.

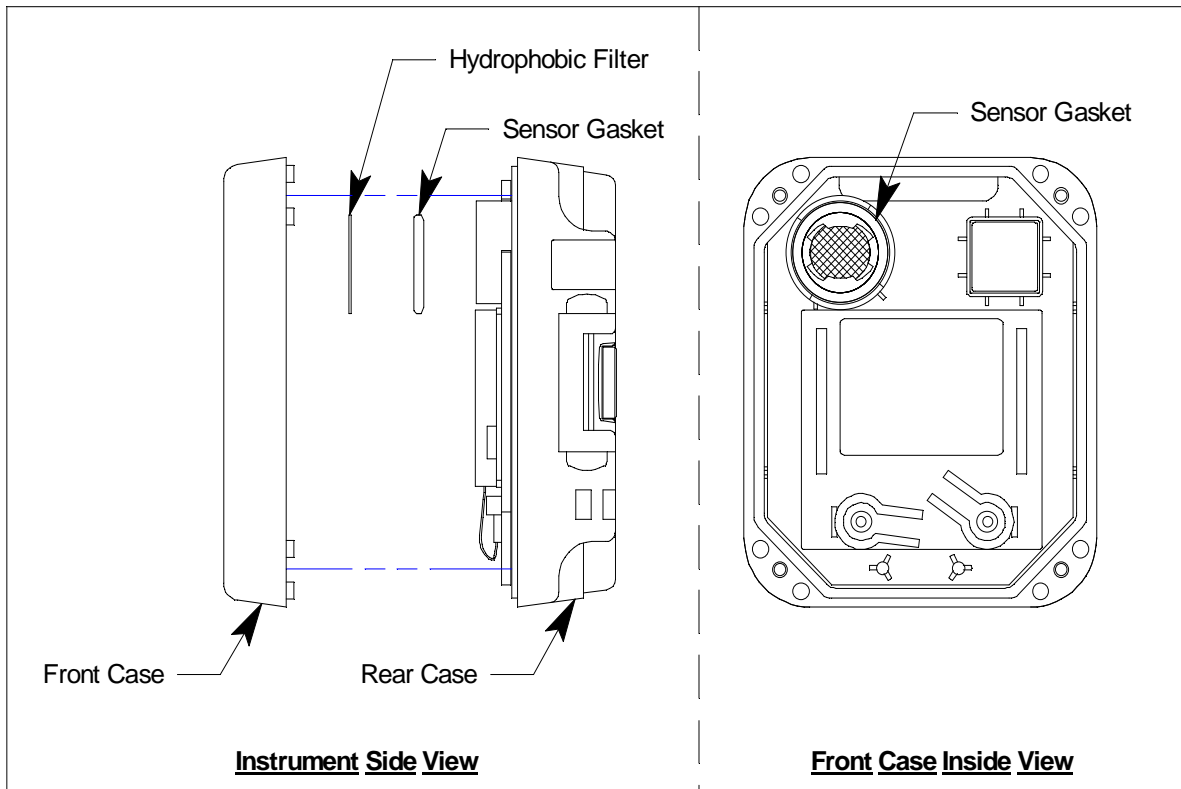

Figure 13: Hydrophobic Filter Location

9. Install a new hydrophobic filter.

10. Reinstall the sensor gasket with the flat side facing the white hydrophobic filter.

11. If necessary, put the sensor in the socket on the rear case. The colored side faces away from the rear case and the slots in the sensor line up with tabs in the socket.

CAUTION: Forcing a sensor into a socket without lining the sensor slots up with the socket tabs may damage the sensor or socket.

12. Reinstall the front case to the rear case.

13. Reinstall the 4 screws that were removed in Step 3.

14. Reinstall the rubber boot, if being used.

Replacing the Sensor

1. Verify that the OX-04 is off.
2. Remove the rubber boot, if installed.
3. Use a small Phillips screwdriver to unscrew the 4 screws that attached the front case to the rear case.

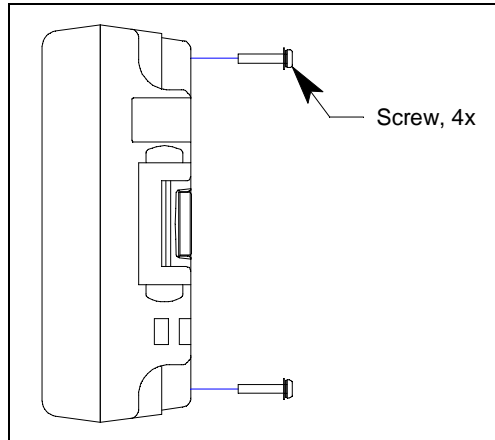

Figure 14: Unscrewing Case Screws

4. Turn the instrument right side up. The screws are not captive and may fall out. Be sure not to lose them.
5. Remove the front case from the rear case.

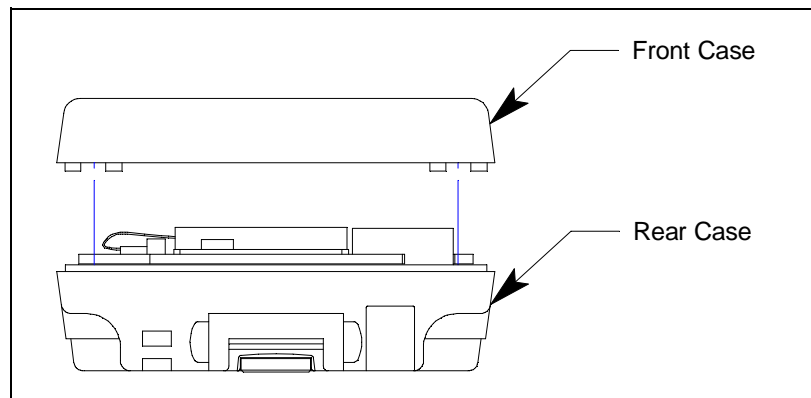

Figure 15: Case Separation

6. Turn the front case upside down.
7. Remove the old sensor. It will either be in its rear case socket or it will be stuck to the sensor gasket in the front case.

8. Install the new sensor in the socket on the rear case. The colored side faces away from the rear case and the slots in the sensor line up with tabs in the socket.

CAUTION: Forcing a sensor into a socket without lining the sensor slots up with the socket tabs may damage the sensor or socket.

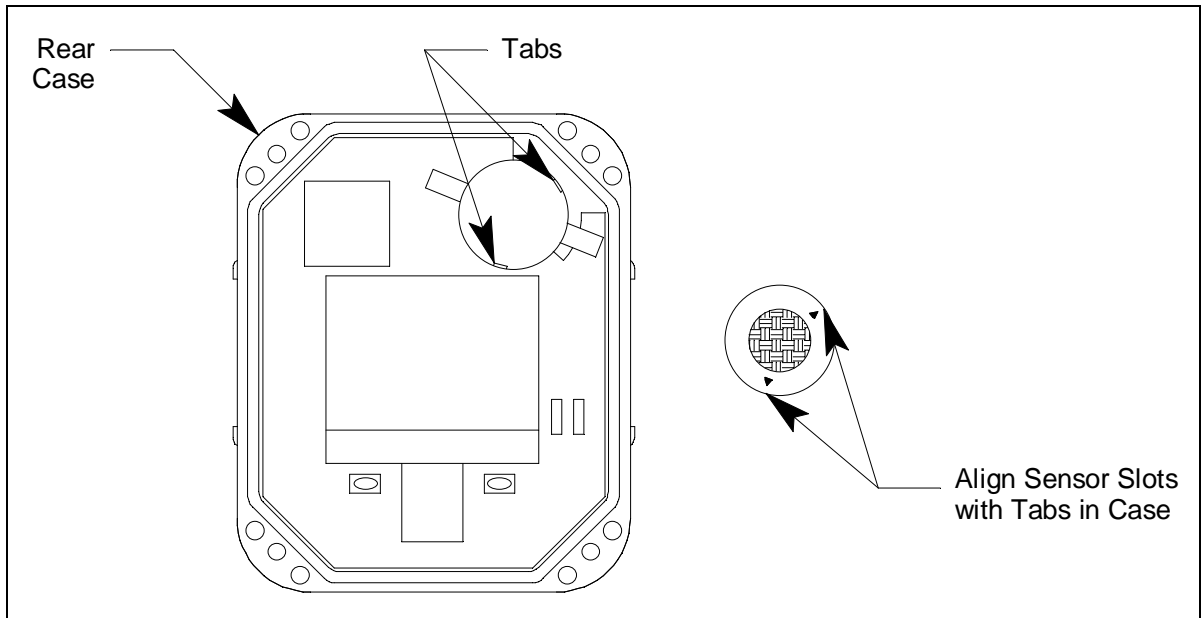

Figure 16: Sensor Location

9. Reinstall the front case to the rear case.
10. Reinstall the 4 screws that were removed in Step 3.
11. Reinstall the rubber boot, if being used.
12. Calibrate the O₂ response as described on page 44.

Chapter 7: General Parts List

Table 13: General Parts List

Part Number	Description
06-1248RK-03	Calibration kit tubing, 3 foot length
07-6033	Sensor gasket
10-1105-01	Screw, for securing front case to rear case
13-0112RK	Wrist strap
13-0122	Belt clip
13-0128	Alligator clip
13-0204RK	Pins for connecting alligator clip/belt clip
20-0325	Rubber boot
33-0715	Hydrophobic filter
47-5084RK	USB/IrDA adapter module, Legasic, for use with all premier portables (without USB cable)
47-5084RK-01	USB/IrDA adapter assembly, Legasic, for use with all premier portables (with module and USB cable)
47-5085RK	Cable, USB A to USB mini, 6 feet, for 47-5084RK USB/IrDA adapter module
49-1110RK	AAA size alkaline battery
49-1312	AAA size Ni-MH battery
49-3105RK	4-battery AA/AAA charger with AC adapter and DC vehicle adapter
49-3106RK	12-battery AA/AAA charger with AC adapter
71-0619	Operator's Manual, OX-04 (this document)
71-0525	Operator's Manual, 04 Series Datalogging Program
71-0526	Operator's Manual, 04 Series Setup Program
81-1050RK-25	Regulator, fixed flow, 0.25 LPM, with gauge and knob, for 17 liter and 34 liter steel cylinders (cylinders with external threads)
81-1051RK-25	Regulator, fixed flow, 0.25 LPM, with gauge and knob, for 34 liter aluminum, 58 liter, and 103 liter cylinders (cylinders with internal threads)
81-1146	Calibration cup
ESR-X13P-OXY	Oxygen (O ₂) sensor

Appendix A: Maintenance Mode

Overview

This appendix describes the OX-04 in Maintenance Mode. The OX-04 is factory-set to suit most applications. Update settings in Maintenance Mode only if required for your specific application. Maintenance Mode items and their factory settings are listed in Table 14 below.

Table 14: Maintenance Mode Menu Items

Maintenance Mode Menu Item	Description		
GAS CAL (page 82)	Perform an air adjust, perform a span adjustment, change the calibration values.		
	AIR	Perform a fresh air adjustment.	
	A-CAL or E-CAL depending on E-CAL User Mode setting	Perform a span adjustment and set the calibration gas concentration.	
		A-CAL (or E-CAL)	Perform an automatic span adjustment.
		START	Begin the warmup sequence and enter Measuring Mode.
		CAL-P	Set the calibration gas concentration.
		ESCAPE	Return to the A-CAL item in the GAS CAL menu.
ESCAPE	Return to the GAS CAL item in Maintenance Mode.		
GAS.TEST (page 82)	Apply gas to test sensor response and observe alarm indicators without an alarm event being recorded.		
SEN.DATE (page 83)	View and/or set the replacement date for the sensor and the batteries.		
BUMP (page 84)	Perform a bump test.		
LATCH (page 84)	<p>ON (factory setting): The OX-04 remains in alarm until the alarm condition passes and POWER MODE is pressed.</p> <p>OFF: The OX-04 automatically resets an alarm when the alarm condition passes.</p>		
D.ZERO (page 85)	<p>ON (factory setting): You can manually perform a fresh air adjust in Measuring Mode by pressing AIR.</p> <p>OFF: You cannot manually perform a fresh air adjust in Measuring Mode by pressing AIR.</p>		
A.ZERO (page 85)	<p>ON: The OX-04 asks if you want to perform a fresh air adjustment at the end of the startup sequence.</p> <p>OFF (factory setting): The OX-04 does not ask if you want to perform a fresh air adjustment at the end of the startup sequence.</p>		

Table 14: Maintenance Mode Menu Items

Maintenance Mode Menu Item	Description
ID DISP (page 86)	ON: User ID and Station ID screens appear in startup sequence. IDs can be changed in Display Mode if DISP.SET in User Mode is also set to ON . OFF (factory setting): User ID and Station ID screens do not appear in startup sequence. IDs cannot be changed in Display Mode.
ZERO.SUP (page 86)	ON (factory setting): Not intended for field adjustment. The suppression value is 0.5% volume.
ZERO.FLW (page 86)	Does not affect the OX-04.
ZSUP.DSP (page 86)	ON: Zero suppression item appears in User Mode. OFF (factory setting): Zero suppression item does not appear in User Mode. (Zero suppression item is always available in Maintenance Mode)
ZFLW.DSP (page 87)	ON: Zero follower item appears in User Mode. OFF (factory setting): Zero follower item does not appear in User Mode. (Zero follower item is always available in Maintenance Mode)
CYL.DISP (page 87)	ON: CYL SEL item appears in GAS CAL . OFF (factory setting): CYL SEL item does not appear in GAS CAL . (RKI Instruments, Inc. does not recommend adjusting this setting.)
DATE (page 87)	Set the current date and time.
PASS-W (page 88)	ON (factory setting): Maintenance Mode is password-protected. Factory-set password is 0400 . OFF: Maintenance Mode is not password-protected.
ROM/SUM (page 89)	View the firmware information for the OX-04's sensor board and main board.
M.DEF (page 89)	Set all parameters back to their RKI factory settings.
START (page 90)	Press and release POWER MODE to begin the warmup sequence and enter Measuring Mode.

Entering Maintenance Mode

WARNING: *The OX-04 is not in operation as a gas detector while in Maintenance Mode.*

1. Take the OX-04 to a non-hazardous location and turn it off if it is on.
2. Press and hold AIR, then press and hold POWER MODE. You will hear a beep after one second. Continue to hold the buttons down.
3. When you hear a second beep, release the buttons.

4. The screen that appears depends on the setting of Maintenance Mode's **PASS-W** item.
 If **PASS-W** is set to **OFF**, continue with Step 8.
 If **PASS-W** is set to **ON** (factory setting), continue with Step 5.

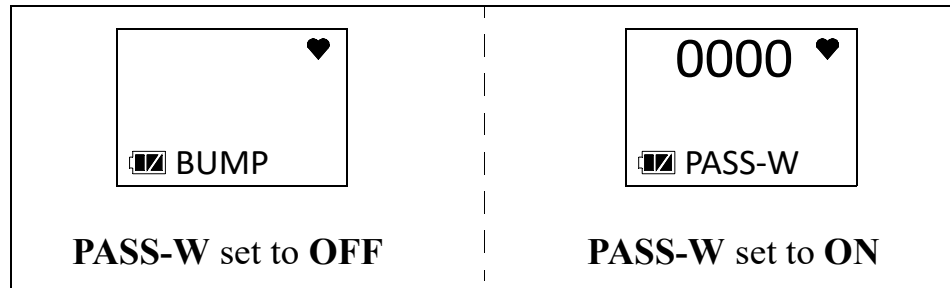

5. If **PASS-W** is set to **ON** in Maintenance Mode, a password screen appears and the first digit is flashing. The factory-set password is **0400** but it can be changed.
6. Use **AIR** to select each password number then press **POWER MODE** to save it and move on to the next number. To go back a number, press and hold **AIR** and **POWER MODE** for a few seconds. To reverse the direction of change (ie. from increasing to decreasing or vice versa):
 - a. Press and hold **AIR**.
 - b. Immediately press **POWER MODE** and then release both buttons.
7. Continue to Step 6.
8. The **GAS CAL** item displays.



9. Use **AIR** to move through the Maintenance Mode items.

Tips for Using Maintenance Mode

- To scroll from one item to the next, press and release **AIR**. To reverse the scrolling direction:
 - a. Press and hold **AIR**.
 - b. Immediately press **POWER MODE** and then release both buttons.
 - c. The scrolling direction returns to the original direction when you exit and reenter a menu.
- To skip an item when a question is asked, press and release **AIR**.
- To enter an item and to save any changes, press and release **POWER MODE**.
- To change a flashing parameter, press and release **AIR**. To reverse the direction of change (i.e. from increasing to decreasing or vice versa):
 - a. Press and hold **AIR**.
 - b. Immediately press **POWER MODE** and then release both buttons.

- To exit an entered item without saving a change, press and hold AIR and POWER MODE for a few seconds.

Performing a Calibration (GAS CAL)

See page 44 for a description of the GAS CAL item.

Performing a Gas Test (GAS.TEST)

The GAS.TEST item allows you to apply gas to the instrument and see all alarm indicators except for the buzzer indicator. There is no buzzer indicator in the GAS.TEST menu even though the buzzer sounds in the event of a real gas alarm condition while in Measuring Mode.

A gas test is not saved in logged data.

Preparing for a Gas Test

To perform a gas test on the OX-04, you need:

- Calibration gas cylinder
 - The concentrations should be above the alarm condition you want to check. Standard alarm points are listed on page 8.
- A 0.25 LPM fixed flow regulator
- Non-absorbent tubing
- Calibration cup

1. Confirm that the regulator knob is turned all the way clockwise. Screw the 0.25 LPM fixed flow regulator onto the calibration cylinder.
2. Install the calibration cup onto the OX-04. Be sure the calibration cup is installed in the correct direction and that it is pushed on all the way.

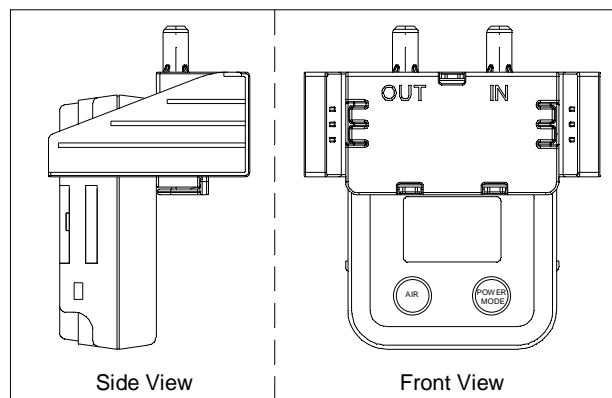

3. Use the tubing to connect the regulator to the inlet of the calibration cup (labeled “IN”).

Performing a Gas Test

1. While in Maintenance Mode, press AIR to scroll to **GAS.TEST**.



2. Press and release POWER MODE. The current gas reading displays. The bottom of the LCD alternates between "GAS.TEST" and "BUZZ.OFF".

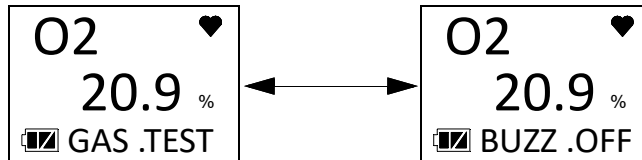

3. Turn the regulator knob counterclockwise to open the regulator.
4. The instrument initiates alarm indicators except for the buzzer. There is no buzzer indicator in the **GAS.TEST** menu even though the buzzer sounds in the event of a real gas alarm condition.
5. Turn the regulator knob clockwise to close the regulator.
6. Unscrew the regulator from the calibration cylinder.
7. Remove the calibration cup from the OX-04.
8. Store the calibration kit in a safe and convenient place.
9. Press and release POWER MODE to return to the **GAS.TEST** item in Maintenance Mode.
10. See "Entering Measuring Mode (START)" on page 90 to enter Measuring Mode.

Sensor/Battery Replacement Date (SEN.DATE)

The **SEN.DATE** item allows you to keep track of when the sensor and the batteries were replaced.

1. While in Maintenance Mode, press AIR to scroll to **SEN.DATE**.



2. Press and release POWER MODE. The sensor replacement date displays.

- Use AIR to scroll to the item with the replacement date you want to view or change.

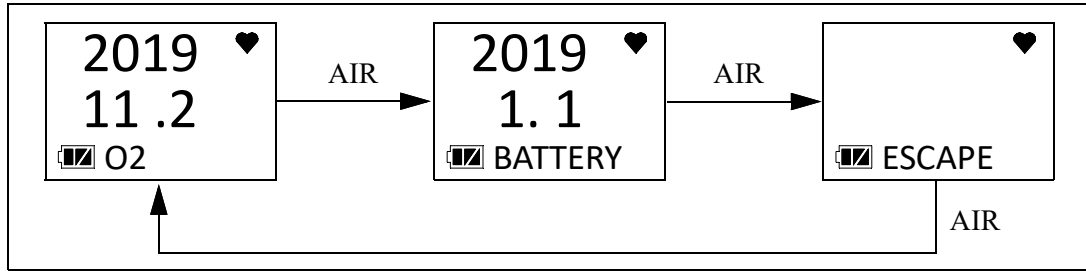

- To change the replacement date:
 - With the desired item displayed, press and release POWER MODE.
 - Press and release POWER MODE again to set the replacement date to the current date.
- Use the AIR button to scroll to **ESCAPE**.
- Press and release POWER MODE to return to the **SEN.DATE** item in Maintenance Mode.
- See “Entering Measuring Mode (START)” on page 90 to enter Measuring Mode.

Performing a Bump Test (BUMP)

See “Performing a Bump Test (BUMP)” on page 42 for a description of the **BUMP** item.

Setting Alarms to Latching or Self-Resetting (LATCH)

ON (factory setting): The OX-04 remains in alarm until the alarm condition passes *and* POWER MODE is pressed.

OFF: The OX-04 automatically resets an alarm when the alarm condition passes.

- While in Maintenance Mode, press AIR to scroll to **LATCH**.



- Press and release POWER MODE. The current setting flashes.
- Use AIR to display the desired setting.
- Press and release POWER MODE to save the setting and return to the **LATCH** item in Maintenance Mode.
- See “Entering Measuring Mode (START)” on page 90 to enter Measuring Mode.

Turning the Demand Zero Function On/Off (D.ZERO)

ON (factory setting): You can manually perform a fresh air adjust in Measuring Mode by pressing AIR.

OFF: You cannot manually perform a fresh air adjust in Measuring Mode.

1. While in Maintenance Mode, press AIR to scroll to **D.ZERO**.

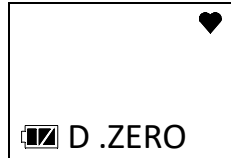

2. Press and release POWER MODE. The current setting flashes.
3. Use AIR to display the desired setting.
4. Press and release POWER MODE to save the setting and return to the **D.ZERO** item in Maintenance Mode.
5. See “Entering Measuring Mode (START)” on page 90 to enter Measuring Mode.

Turning the Auto Zero Function On/Off (A.ZERO)

ON: The OX-04 asks if you want to perform a fresh air adjustment at the end of the startup sequence.

OFF (factory setting): The OX-04 does not ask if you want to perform a fresh air adjustment at the end of the startup sequence.

1. While in Maintenance Mode, press AIR to scroll to **A.ZERO**.

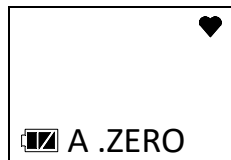

2. Press and release POWER MODE. The current setting flashes.
3. Use AIR to display the desired setting.
4. Press and release POWER MODE to save the setting and return to the **A.ZERO** item in Maintenance Mode.
5. See “Entering Measuring Mode (START)” on page 90 to enter Measuring Mode.

Turning the ID Display Function On/Off (ID DISP)

ON: The User ID and Station ID screens appear in the startup sequence. If **DISP.SET** in User Mode is also set to **ON**, then the IDs can be changed in Display Mode.

OFF (factory setting): The User ID and Station ID screens do not appear in the startup sequence and the IDs cannot be changed in Display Mode.

1. While in Maintenance Mode, press AIR to scroll to **ID DISP**.



2. Press and release POWER MODE. The current setting flashes.
3. Use AIR to display the desired setting.
4. Press and release POWER MODE to save the setting and return to the **ID DISP** item in Maintenance Mode.
5. See “Entering Measuring Mode (START)” on page 90 to enter Measuring Mode.

Turning the Zero Suppression On/Off (ZERO.SUP)

The **ZERO.SUP** setting is not intended for field adjustment. The default setting is **OFF**. The suppression value is 0.5% volume.

Turning the Zero Follower On/Off (ZERO.FLW)

The **ZERO.FLW** setting is not intended for field adjustment. The default setting is **OFF**.

User Mode Zero Suppression (ZSUP.DSP)

ON: Zero suppression item appears in User Mode.

OFF (factory setting): Zero suppression item does not appear in User Mode. The zero suppression item is always available in Maintenance Mode.

It is not normally necessary to have the zero suppression item appear in User Mode. Contact RKI Instruments before turning this setting on.

User Mode Zero Follower (ZFLW.DSP)

ON: Zero follower item appears in User Mode.

OFF (factory setting): Zero follower item does not appear in User Mode. The zero follower item is always available in Maintenance Mode.

It is not normally necessary to have the zero follower item appear in User Mode. Contact RKI Instruments before turning this setting on.

Cylinder Setting (CYL.DISP)

ON: CYL SEL item appears in User and Maintenance Modes' GAS CAL item.

OFF (factory setting): CYL SEL item does not appear in User and Maintenance Modes' GAS CAL item.

Setting the Date/Time (DATE)

1. From the main menu, place the cursor next to **DATE**.



2. Press and release POWER MODE. The date and time display with the year flashing.

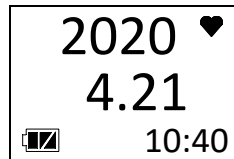

3. Use AIR to display the desired year.
4. Press and release POWER MODE to save the setting. The month setting flashes.
5. Repeat Step 3 and Step 4 to enter the month, day, hours, and minutes settings (in 24-hour format). The date and time are saved and the instrument returns to the **DATE** item in Maintenance Mode.
6. See "Entering Measuring Mode (START)" on page 90 to enter Measuring Mode.

Turning the Password On/Off (PASS-W)

ON (factory setting): The OX-04 prompts you for a password when you enter Maintenance Mode. The factory-set password is **0400** but it can be changed.

OFF: No password is required to enter Maintenance Mode.

1. While in Maintenance Mode, press AIR to scroll to **PASS-W**.

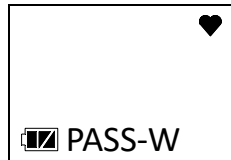

2. Press and release POWER MODE. The current setting flashes.
3. Use AIR to display the desired setting.
4. If you selected **OFF**, press and release POWER MODE to save the setting and return to the **PASS-W** item in User Mode.
If you selected **ON**, continue with to the next step.
5. Press and release POWER MODE. The Set Password Screen appears. The current password displays and the first digit flashes.

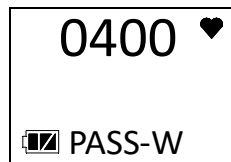

6. Use AIR to display a number from 0 to 9.
7. Press and release POWER MODE to enter the selection and advance to the next number. To go back a number, press and hold AIR and POWER MODE for a few seconds.
8. Repeat Step 6 and Step 7 to select the remaining numbers. When you press and release POWER MODE to enter the last number, the password is saved and the instrument returns to the **PASSWORD** item in Maintenance Mode.
9. See "Entering Measuring Mode (START)" on page 90 to enter Measuring Mode.

Viewing the ROM/SUM (ROM/SUM)

The **ROM/SUM** screen shows the instrument's firmware version and firmware checksum.

1. While in Maintenance Mode, press AIR to scroll to **ROM/SUM**.

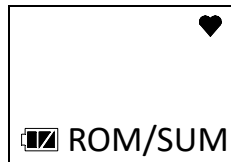

2. Press and release POWER MODE. The screen shows the ROM/SUM. The ROM is the top value and the SUM is the bottom value.

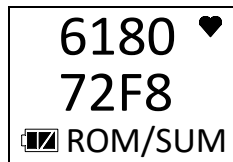

3. Press and release POWER MODE to return to the **ROM/SUM** item in Maintenance Mode.
4. See "Entering Measuring Mode (START)" on page 90 to enter Measuring Mode.

Performing a Default (M.DEF)

Performing a default operation in Maintenance Mode returns all parameters to their RKI factory settings.

1. While in Maintenance Mode, press AIR to scroll to **M.DEF**.



2. Press and release POWER MODE.

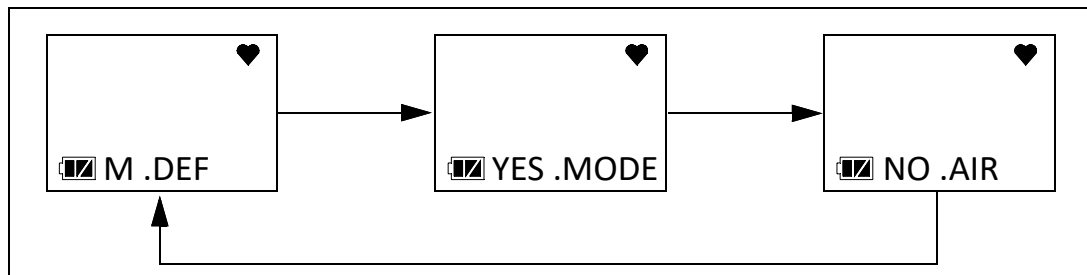

3. Press and release POWER MODE to perform a default operation. The instrument asks if you are sure you want to perform a default operation.

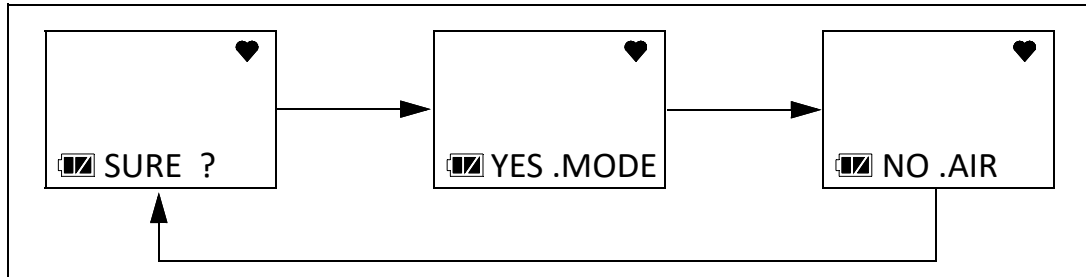

4. Press and release POWER MODE to perform a default operation. The instrument beeps twice and returns to the **M.DEF** item in Maintenance Mode.
5. See “Entering Measuring Mode (START)” on page 90 to enter Measuring Mode.

Entering Measuring Mode (START)

1. While in Maintenance Mode, press AIR to scroll to **START**.



2. Press and release POWER MODE. The instrument begins its warmup sequence.

Appendix B: Gas Select Mode

Overview

This appendix describes the OX-04 in Gas Select Mode. The OX-04 is factory-set to suit most applications. Update settings in Gas Select Mode only if required for your specific application. A description of the Gas Select Mode items is shown in Table 15 below.

Table 15: Gas Select Mode Menu Items

Menu Item (Page # of Description)	Description
SAVE-AP (page 92)	Set the current alarm points as the default alarm points.
MAX.SPAN (page 93)	ON : Maximum span screen appears after a successful calibration. OFF (factory setting): No maximum span screen appears.
STEALTH (page 94)	STEALTH ON : No backlight, LED, or buzzer operation. STEALTH OFF (factory setting): Backlight, LED, and buzzer operate normally.
	This setting has no effect unless STEALTH is set to ON. VIB ON : Vibrator activates for alarm conditions. VIB OFF (factory setting): Vibrator does not activate in any situation.
START (page 95)	Enter Measuring Mode

Entering Gas Select Mode

WARNING: The OX-04 is not in operation as a gas detector while in Gas Select Mode.

1. Take the OX-04 to a non-hazardous location and turn it off if it is on.
2. Press and hold AIR, then press and hold POWER MODE. You will hear a beep after one second. Continue to hold the buttons down.
3. You will hear a second beep. Continue to hold the buttons down.
4. When you hear a third beep, release the buttons.
5. A password screen appears and the first digit flashes. The password is **2014**.

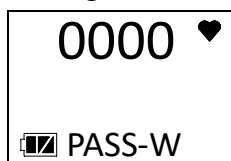

- Use AIR to select each password number then press POWER MODE to save it and move on to the next number. To go back a number, press and hold AIR and POWER MODE for a few seconds.
- The **SAVE-AP** item displays.



- Use AIR to move through the Gas Select Mode items.

Tips for Using Gas Select Mode

- To scroll from one item to the next, press and release AIR. To reverse the scrolling direction:
 - Press and hold AIR.
 - Immediately press POWER MODE and then release both buttons.
 - The scrolling direction returns to the original direction when you exit and reenter a menu.
- To skip an item when a question is asked, press and release AIR.
- To enter an item and to save any changes, press and release POWER MODE.
- To change a flashing parameter, press and release AIR. To reverse the direction of change (ie. from increasing to decreasing or vice versa):
 - Press and hold AIR.
 - Immediately press POWER MODE and then release both buttons.
- To exit an entered item without saving a change, press and hold AIR and POWER MODE for a few seconds.

Saving the Alarm Points (SAVE-AP)

Performing a **SAVE-AP** operation saves the current alarm setpoints.

Performing a **DEF.ALMP** operation in the **ALARM-P** User Mode menu sets the instrument's alarm points to those saved during the **SAVE-AP** operation (if performed).

Performing a **SAVE-AP** has no effect on an **M.DEF** in Maintenance Mode. An **M.DEF** operation returns all instrument settings to the RKI default regardless of if a **SAVE-AP** operation was performed.

- While in Gas Select Mode, press AIR to scroll to **SAVE-AP**.



2. Press and release POWER MODE. The display cycles through the following screens.

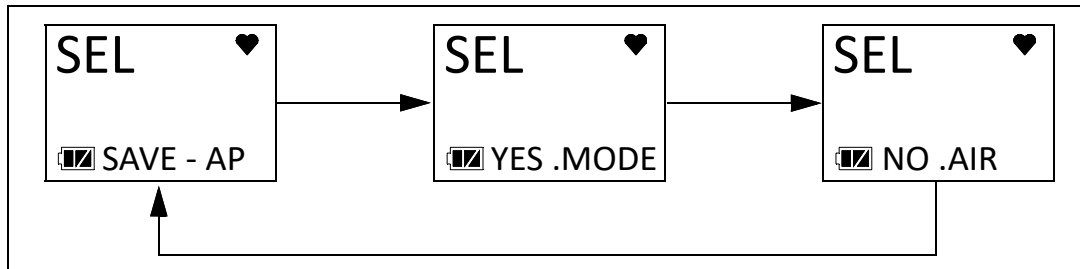

3. Press and release POWER MODE to save the current alarm point settings as the default.
4. The instrument returns to the **SAVE-AP** item in Gas Select Mode.
5. See “Exiting Gas Select Mode (START)” on page 95 to enter Measuring Mode.

Turning Calibration Max Span On/Off (MAX.SPAN)

ON: After a passed calibration, the OX-04 displays the response reading’s maximum adjustment. A maximum span of 25.0% volume indicates that the reading could have been adjusted up to 25.0% volume. If the maximum span value is close to the calibration value, the sensor should be replaced soon. The upper limit on the maximum adjustment indicated is either twice the calibration value or full scale, whichever is lower.

OFF (factory setting): There is no maximum span indicator at the end of a calibration.

1. While in Gas Select Mode, press AIR to scroll to **MAX.SPAN**.



2. Press and release POWER MODE. The current setting flashes.
3. Use AIR to display the desired setting.
4. Press and release POWER MODE to save the setting and return to the **MAX.SPAN** item in Gas Select Mode.
5. See “Exiting Gas Select Mode (START)” on page 95 to enter Measuring Mode.

Stealth and Vibrator Settings (STEALTH)

STEALTH

ON:

- The instrument's backlight does not come on, regardless of the **BL TIME** setting.
- The instrument's LED does not come on for any reason, even alarm conditions.
- The instrument's buzzer does not sound for any reason, even alarm conditions.
- An "S" appears at the bottom of the LCD.

OFF (factory setting): The instrument's backlight, LED, and buzzer operate normally.

VIB

The **VIB** setting only affects instrument operation if **STEALTH** is set to **ON**.

ON: The vibrator activates for alarm conditions. It can be useful to have this feature turned on if you have also turned **STEALTH** on.

OFF (factory setting): The vibrator does not activate for any reason.

1. While in Gas Select Mode, press AIR to scroll to **STEALTH**.



2. Press and release POWER MODE. The current **STEALTH** setting flashes.
3. Use AIR to display the desired setting.
4. Press and release POWER MODE. The current **VIB** setting flashes.
5. Use AIR to display the desired setting.
6. Press and release POWER MODE to save the setting and return to the **STEALTH** item in Gas Select Mode.
7. See "Exiting Gas Select Mode (START)" on page 95 to enter Measuring Mode.

Exiting Gas Select Mode (START)

1. While in Gas Select Mode, press AIR to scroll to **START**.



2. Press and release POWER MODE. The instrument begins its warm-up sequence.

Product Warranty

RKI Instruments, Inc. warrants the OX-04 sold by us to be free from defects in materials, workmanship, and performance for a period of three years from the date of shipment from RKI Instruments, Inc. This includes the instrument and the original sensor. Replacement parts are warranted for 1 year from the date of their shipment from RKI Instruments, Inc. except for replacement sensors which are warranted for 3 years. Any parts found defective within their warranty period will be repaired or replaced, at our option, free of charge. This warranty does not apply to those items which by their nature are subject to deterioration or consumption in normal service, and which must be cleaned, repaired, or replaced on a routine basis. Examples of such items are:

- Absorbent cartridges
- Filter elements, disks, or sheets
- Pump diaphragms and valves

Warranty is voided by abuse including mechanical damage, alteration, rough handling, or repair procedures not in accordance with the instruction manual. This warranty indicates the full extent of our liability, and we are not responsible for removal or replacement costs, local repair costs, transportation costs, or contingent expenses incurred without our prior approval.

THIS WARRANTY IS EXPRESSLY IN LIEU OF ANY AND ALL OTHER WARRANTIES AND REPRESENTATIONS, EXPRESSED OR IMPLIED, AND ALL OTHER OBLIGATIONS OR LIABILITIES ON THE PART OF RKI INSTRUMENTS, INC. INCLUDING BUT NOT LIMITED TO, THE WARRANTY OF MERCHANTABILITY OR FITNESS FOR A PARTICULAR PURPOSE. IN NO EVENT SHALL RKI INSTRUMENTS, INC. BE LIABLE FOR INDIRECT, INCIDENTAL, OR CONSEQUENTIAL LOSS OR DAMAGE OF ANY KIND CONNECTED WITH THE USE OF ITS PRODUCTS OR FAILURE OF ITS PRODUCTS TO FUNCTION OR OPERATE PROPERLY.

This warranty covers instruments and parts sold to users only by authorized distributors, dealers and representatives as appointed by RKI Instruments, Inc.

We do not assume indemnification for any accident or damage caused by the operation of this gas monitor and our warranty is limited to replacement of parts or our complete goods.



EU-Declaration of Conformity

Document No.: 320CE22057



We, RIKEN KEIKI Co., Ltd. 2-7-6, Azusawa, Itabashi-ku, Tokyo, 174-8744 Japan declare under our sole responsibility that the following product conforms to all the relevant provisions.

Product Name: Portable Gas Monitor
Model: OX-04,OX-04G,HS-04,CO-04,CX-04,SC-04

Council Directives		Applicable Standards
2014/34/EU	ATEX Directive	EN IEC 60079-0:2018 EN 60079-11:2012
2014/30/EU	EMC Directive	EN 50270:2015
2011/65/EU ^[1]	RoHS Directive	EN IEC 63000:2018

^[1]Including substances added by Commission Delegated Directive (EU) 2015/863

EU-Type examination Certificate No. DEKRA 19ATEX0097

Notified Body for ATEX DEKRA Certification B.V. (NB 0344)
Meander 1051,6825 MJ Arnhem
P.O.Box5185,6802 ED Arnhem
The Netherlands

Auditing Organization for ATEX DNV Product Assurance AS (NB 2460)
Veritasveien 1
1363 Høvik
Norway

The marking of the product shall include the following:

 II 1 G Ex ia IIC T4/T3 Ga

Alternative Marking: T4:when equiped with primary batteries
T3:when equiped with secondary batteries

Place: Tokyo, Japan

Date: Jun. 29, 2022

Takakura Toshiyuki
General manager
Quality Control Center



UK-Declaration of Conformity

Document No. 320UK23002



We, RIKEN KEIKI Co., Ltd. 2-7-6, Azusawa, Itabashi-ku, Tokyo, 174-8744, Japan declare under our sole responsibility that the following product conforms to all the relevant provisions.

Product Name Portable Gas Monitor
Model OX-04, OX-04G, HS-04, CO-04, CX-04, SC-04

Regulations	UK designated Standards
Electromagnetic Compatibility Regulations 2016 (S.I. 2016/1091)	BS EN 50270:2015
The Equipment and Protective Systems Intended for Use in Potentially Explosive Atmospheres Regulations 2016 (S.I. 2016/1107) (UKEX)	BS EN IEC 60079-0:2018 BS EN 60079-11:2012
The Restriction of the Use of Certain Hazardous Substances in Electrical and Electronic Equipment Regulations 2012 (S.I. 2012/3032)	BS EN IEC 63000:2018

UK-Type examination Certificate No.

DEKRA 21UKEX 0357

Approved Body for UKEX

DEKRA Certification UK Ltd (AB8505)
Stokenchurch House, Oxford Road,
Stokenchurch, Buckinghamshire HP14 3SX,
United Kingdom

Auditing Organization for UKEX

DNV Business Assurance UK Ltd (AB8501)
4th Floor Vivo Building, 30 Stamford Street,
London SE1 9LQ, United Kingdom

The marking of the product shall include the following



II 1 G Ex ia IIC T4/T3 Ga

Alternative Marking

Ex ia IIC T4 Ga (when equipped with primary batteries)

Ex ia IIC T3 Ga (when equipped with secondary batteries)

Place: Tokyo, Japan

Date: Aug. 31, 2023

Takakura Toshiyuki
General manager
Quality Control Center

Safety Information

This product is a portable single-gas/two-gas monitor to detect gas.

This product uses two AAA alkaline batteries (Toshiba LR03 or Duracell MN2400/PC2400) or two AAA Ni-MH batteries (Panasonic eneloop (BK-4MCC)) for power supply. Perform battery replacement only in a non-hazardous area.

<Japanese explosion-proof specifications>

Explosion-proof construction	Intrinsically safe explosion-proof construction
Explosion-proof class	Ex ia IIC T4 Ga (Dry cell specifications) Ex ia IIC T3 Ga (Rechargeable battery specifications)
Ambient temperature*	-40 °C to +60 °C
Rating	Power source: Toshiba LR03 battery × 2 (3 V DC, 1 mA)
Applicable guidelines	JNIOSH-TR-46-1: 2015 JNIOSH-TR-46-6: 2015

*The ambient temperature refers to temperatures in the range within which explosion-proof performance can be maintained. It does not imply the temperature range within which the required product performance may be achieved. For information on the operating temperature range, refer to '10. Product Specifications'.

<ATEX/IECEX/UKEX specifications>

Explosion-proof construction Intrinsically safe explosion-proof construction

Explosion-proof class Ex ia IIC T4/T3 Ga
 II 1G Ex ia IIC T4/T3 Ga

Ambient temperature* -40 °C to +60 °C

Electrical specifications T4: Powered by two Toshiba LR03 or Duracell MN2400/PC2400 AAA series-connected alkaline batteries (Use only Toshiba LR03 for Japan models.)
T3: Powered by two Panasonic eneloop (BK-4MCC) series-connected AAA Ni-MH batteries

Certificate numbers • IECEX: IECEX DEK 19.0059
• ATEX: DEKRA 19 ATEX 0097
• UKEX: DEKRA 21 UKEX 0357

Applicable standards • IEC 60079-0:2017 • EN IEC 60079-0:2018 • BS EN IEC 60079-0:2018
• IEC 60079-11:2011 • EN60079-11:2012 • BS EN60079-11:2012

*The ambient temperature refers to temperatures in the range within which explosion-proof performance can be maintained. It does not imply the temperature range within which the required product performance may be achieved. For information on the operating temperature range, refer to '10. Product Specifications'.



WARNING

- Do not replace batteries in hazardous locations.
 - Do not attempt to disassemble or alter the product.
 - Use only two series-connected AAA alkaline batteries, LR03 manufactured by Toshiba or MN2400/PC2400 by Duracell, or use two series-connected AAA Ni-MH batteries, eneloop (BK-4MCC) manufactured by Panasonic.
 - T4: LR03 manufactured by Toshiba or MN2400/PC2400 by Duracell
(Only LR03 by Toshiba can be used for Japan models.)
 - T3: eneloop (BK-4MCC) manufactured by Panasonic
-

INST. No. 0 0 0 0 0 0 0 0 0 0 0
 A B C D E

A: Manufacturing year (0-9)

B: Manufacturing month (1-9, XYZ for Oct.-Dec.)

C: Manufacturing lot

D: Serial number

E: Code of factory



RIKEN KEIKI Co., Ltd.

2-7-6 Azusawa, Itabashi-ku, Tokyo, 174-8744, Japan

Phone: +81-3-3966-1113
Fax: +81-3-3558-9110
Email: intdept@rikenkeiki.co.jp
Website: <https://www.rikenkeiki.co.jp>