



**HRC/4RC-SERIES
REGENERATIVE BLOWER
Installation &
Operating Instructions**



Republic Regenerative Blowers

HRC100-HRC1502 • 4RC210-4RC630

Installation Instructions & Operating Manual

Republic Manufacturing®
5131 Cash Road
Dallas, TX 75247
(214) 631-8070
www.republic-mfg.com
info@republic-mfg.com

Warning

 Service procedures beyond the scope of this manual should only be performed by trained service personnel at Republic Manufacturing.

Important

Read the following safety instructions carefully. Disconnect blower from electrical source using an approved lockout/tagout procedure before attempting service

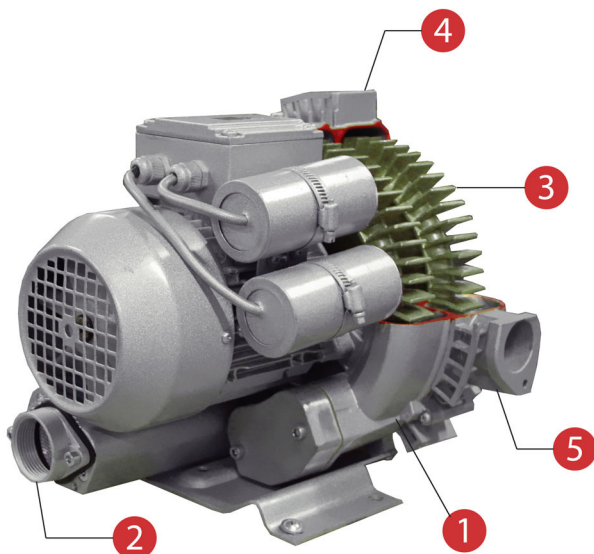

1. Side channel
2. Air inlet
3. Impeller
4. Impeller chamber
5. Exhaust outlet

Working Principle

Air or gas is pulled into a side channel (1) through the air inlet (2) and is accelerated by an impeller (3) rotating inside the impeller chamber (4). The resulting pressurized air or gas is discharged through the exhaust outlet (5). This type of operation is also known as a ring blower design.

Table of Contents

Safety Instructions	5
Lockout/Tagout Procedures	6
Blower Description & Model Identification	6
Equipment Arrival & Inspection.....	6
Storage Conditions	7
Suitability & Environmental Conditions.....	7
Space Required for Installation.....	7
Intended Use.....	8
This operating manual.....	8
The HRC100-1502 & 4RC210-630	8
Foreseeable Misuse	8
Technical Data.....	9
Tightening Torques for Screw Connections.....	11
Installation	12
Plumbing & Accessories.....	12
Typical Pressure Layout.....	13
Typical Vacuum Layout	13
Electrical Connection.....	14
Wiring Diagram - Single Phase	15
Wiring Diagram - Three Phase.....	15
Commissioning.....	16
Preparation.....	16
Start-Up	16
Shut-Down.....	16
Operation	17
Shut-Down & Longer Standstills.....	17
Servicing	17
Emptying/Rinsing/Cleaning.....	17
Preventative Maintenance.....	17
Troubleshooting	19
In the Event of a Breakdown	20
When to Ship the Blower Back to Republic.....	20
Disabling, Dismantling, and Scrapping of Blower.....	20
Warranty Terms and Conditions.....	20
Exploded View	21
Republic Regenerative Blower Exploded View Double Stage Blowers.....	35



Safety Instructions

To insure safe operation, we have provided many important safety guidelines in this manual for the Republic Regenerative Blower. Please read this manual carefully and pay particular attention to instructions with the following signs:

DANGER: Indicates an imminently hazardous situation which, if not avoided, will result in death or serious injury.

WARNING: Indicates a potentially hazardous situation which, if not avoided, could result in death or serious injury.

1. Always use qualified electrical and mechanical personnel for installation and maintenance of Republic Blowers and motors.



2. Disconnect the electrical power at the motor starter, fuse box or circuit breaker before working on the system. Take special precautions to make sure the power cannot be turned on while you are working on the blower. **Use an approved lockout/tagout system.**

3. Make sure the motor is electrically grounded, the mounting bolts are properly secured, and all guards are in place before start-up.



4. Wear safety glasses and earplugs when working on the blower or components within a Republic Blower system.

5. **Check the final installation for proper amp loads.**

6. Keep all tools, loose clothing and hands away from rotating or moving parts while the unit is running.

7. Inspect the blower at regular intervals for damaged or worn parts. **Replace damaged parts immediately! Do not connect or turn on a damaged blower!**

8. Inspect the inlet air filter at regular intervals and replace when necessary. A dirty air filter can cause improper blower performance.

9. Use only genuine Republic Manufacturing brand replacement parts.

10. Refer to Troubleshooting section of manual.

11. Make sure to install the inlet air filter or piping to blower inlet before starting the blower/motor.

12. Water, other liquids, aggressive or inflammable gases and vapors may not be handled. Handling of inflammable or aggressive gases and vapors is only possible with special versions.

13. Improper use of the unit can result in serious or even fatal injuries. Only operate the blower for the purposes indicated under "Intended Use", with the fluids indicated under "Intended Use" and with the values indicated under "Technical Data".



14. High temperatures of up to approximately 320°F (160°C) can occur on the surface of the blower. Allow to cool down after shut-down.





Lockout/Tagout Procedures



1. Notify all affected employees that a lockout or tagout is about to occur on a specific piece of equipment or machinery. The authorized employee to use the lockout/tagout system shall know the type and magnitude of energy that the machine or equipment utilizes and the hazards that exist with the energy source before preparing to shutdown.
2. If the machine or equipment is operating, please use normal stopping or rundown procedures for that machine.
3. Operate the switch, valve, or other energy isolating devices so that the equipment is isolated from its energy source. Isolating the equipment from its energy source may involve turning off such items as the operating control, a line valve, or an electrical circuit breaker.
4. Apply the lockout/tagout isolating device with assigned individual locks or tags.
5. Release any potentially-hazardous stored or residual energy. In order to do so, this may mean to return springs to a normal position, or bleeding down. Since the machine must be in a zero energy state, if there is any chance the stored energy may reaccumulate, verification of isolation must be continued until the servicing or maintenance is complete.
6. The machine or equipment is now locked out or tagged out.

Blower Description & Model Identification

Republic Manufacturing Regenerative Blowers are industrial grade regenerative blowers capable of producing high pressure air at low operating costs. Many models are available within each series:

- ▲ HRC-Series: Standard regenerative blowers with integral motor operating at 50 or 60 Hz, with 3 or 1 phase motor. 0.5-38.9 HP (0.4-29.0 kW) Motor Sizes
- ▲ 4RC-Series: High pressure regenerative blowers with integral motor operating at 50 or 60 Hz, with 3 or 1 phase motor. 0.7-11.5 HP (0.5-8.6 kW)

Republic Blowers have a nameplate containing the serial and model number located on the blower head near the exhaust port. When placing a service call, please provide the Republic serial number. Call us at (800) 847-0380 or e-mail info@republic-mfg.com.

- ▲ Models come with 1.25 in. (31.8 mm), 2.0 in. (50.8 mm), 2.5 in. (63.5 mm), or 4 in. (101.6 mm) inlet and ports; and can accommodate piping/hose in 1.25 in. (31.8mm), 20 in. (50.8 mm), 2.5 in. (63.5 mm), or 4 in. (101.6 mm) connections.
- ▲ All models can be mounted in a variety of positions. (Please refer to Installation section of manual.)

Equipment Arrival & Inspection

Inspect the blower system at time of receipt to ensure that all components and accessories, as noted on the packing slip, were received and in good condition. Verify that the serial number on the packing slip matches the serial number shown on the blower head nameplate. Inspect the blower and motor assembly to ensure that the motor horsepower and voltage are correct.

If any equipment was damaged in transit, you will need to make a claim against the freight carrier immediately. If you have any shortages, discrepancies, or damage, please call your Republic Manufacturing Distributor or Republic Manufacturing at (800) 847-0380. No training required.

Storage Conditions

1. Must store blower in a place that meets the following conditions: clean, dry, and dust-free.
2. The temperature during storage must be between 32 (0°C) and 104°F (40°C).

Long Term Storage









The new blower may initially be stored following delivery.

1. Under advantageous storage conditions (as specified above): 1 year.
2. Under disadvantageous storage conditions (e.g. high humidity, salty air, sandy or dusty air): Inquire with Republic Manufacturing regarding service at (800) 847-0380.

Commissioning After Longer Standstill:

Before recommissioning after a longer standstill, measure the insulation resistance of the drive motor. With values $\leq 1\text{k}\Omega$ per volt of nominal voltage, the winding is too dry.

Suitability & Environmental Conditions

-  The units are suitable for the use in the industrial field.
-  Use only clean, dry air. Do not use explosive gases or atmosphere that contains such gases.
-  The ambient and suction temperatures must be between 32°F (0°C) and 104°F (40°C). For temperatures outside this range please contact your supplier.
-  In all applications where an unplanned shut down of the blower could possibly cause harm to persons or installations, a corresponding safety backup system must be installed.
-  Protect all surrounding items from exhausted air. This exhausted air can be very hot.
-  Protect unit from contaminants and moisture. Air particles, water vapor, oil-based contaminants or other liquids must be removed.
-  Blower must be installed with the proper-sized inlet and inline filter, gauge and relief valve to protect the blower from contaminants and over-heating, overpressure.
-  When using the blower at a high altitude or high temperatures, please consult with Republic Manufacturing prior to use.

Space Required for Installation

1. Allow at least 3 inches (76.2 mm) of clearance for removal and venting at the fan guard.
2. Allow at least 2 inches (50.8 mm) of clearance around the face of the blower cover.
3. Please refer to the blower dimensional drawings on individual specification sheets to determine the appropriate machine footprint.



Intended Use

This operating manual

- is intended for regenerative blowers models HRC100-HRC1502 and 4RC210-4RC630.
- contains instructions regarding transport and handling, installation, commissioning, operation, shut-down, storage, services, and disposal.
- must be completely read and understood by all operating and servicing personnel before beginning to work with or on the blowers.
- must be strictly observed.
- must be available at the site of operation.

The HRC100-1502 & 4RC210-630

- are blower-motor units for generating vacuum or pressure.
- are used to extract, pump and compress the following gases:
 - Air.
 - Non-flammable, non-aggressive, non-toxic and non-explosive gases or gas-air mixtures.
 - With differing gases/gas-air mixtures, inquire with Republic Manufacturing.
- are equipped with one of the following kind of drive motors:
 - 3-phase AC drive motor with a standard, or
 - Single-phase AC drive motor.

These operating instructions apply only to blower units with a standard design:

- are intended for industrial applications.
- are designed for continuous operation. With increased switch-on frequency (6x per hour with equal pauses and operating times) or with increased gas inflow and ambient temperature, the excess temperature limit of the coil and the bearing can be exceeded. Consult Republic Manufacturing under such conditions.

The limits listed in “Technical Data” must always be complied with when operating Republic Regenerative Blowers.

Foreseeable Misuse

It is prohibited

- to use the HRC100-HRC1502 or 4RC210-4RC630 in applications other than industrial applications unless the necessary protection is provided on the system, e.g. guards suitable for children’s fingers;
- to use the device in areas in which explosive gases can occur if the blower is not expressly intended for this purpose;
- to extract, to deliver and to compress explosive, flammable, corrosive or toxic fluids, unless the blower is specifically designed for this purpose;
- to operate the blower with values other than those specified in “Technical Data”.

Any unauthorized modifications of the blower are prohibited for safety reasons. The operator is only permitted to perform the maintenance and service work described in these operating instructions. Maintenance and servicing work which goes beyond this may only be carried out by companies which have been authorized by Republic Manufacturing.

Technical Data

Blower	Weight		Noise Level (dBa)	Blower	Weight		Noise Level (dBa)
	lb	kg			lb	kg	
HRC100	22	10	53	HRC102	33	15	68
HRC101	24	11	56	HRC202	33	15	61
HRC200	30	15	64	HRC202/1	35	16	61
HRC201	30	15	64	HRC302	40	18	60
HRC220	40	18	64	HRC302/1	38	17	60
HRC221	37	17	65	HRC402S	55	25	69
HRC250	40	18	65	HRC402	60	27	6
HRC300	51	23	70	HRC402/1	68	31	72
HRC340	53	24	70	HRC502	78	35	74
HRC350	57	26	71	HRC602	88	40	74
HRC301	53	24	70	HRC702	90	41	74
HRC400	57	26	70	HRC752	108	49	76
HRC401	57	26	70	HRC802	123	56	76
HRC500	68	31	72	HRC902	154	70	76
HRC501	66	30	74	HRC1002	163	74	76
HRC600	79	36	72	HRC1102	230	104	78
HRC700	88	40	72	HRC1202	265	120	78
HRC720	82	37	73	HRC1302	412	187	78
HRC730	95	43	73	HRC1402	434	197	78
HRC750	112	51	74	HRC1452	450	204	78
HRC800	137	62	82	HRC1502	465	211	78
HRC900	143	65	82				
HRC1000	265	121	82				
HRC1020	126	57	74				
HRC1040	146	66	74				
HRC1060	153	69	74				
HRC1100	205	93	79				
HRC1200	256	116	79				
HRC1300	278	126	79				
HRC1320	216	98	80				
HRC1340	267	121	80				
HRC1360	289	131	80				



Blower	Weight		Noise Level (dBa)	Blower	Weight		Noise Level (dBa)
	lb	kg			lb	kg	
4RC210-A75	40	20	62	4RC220-A75	67	34	62
4RC210-H16	36	18	62	4RC220-H26	53	27	62
4RC310-A71	40	20	62	4RC220-H56	67	34	62
4RC310-H16	36	18	62	4RC320-A75	79	36	63
4RC310-H26	36	18	62	4RC320-H46	71	32	63
4RC410-A41	57	26	62	4RC320-H56	75	34	63
4RC410-H16	57	26	62	4RC420-H26	82	37	66
4RC510-H16	64	29	68	4RC420-H56	95	43	66
4RC510-H26	70	32	68	4RC520-H26	100	45	70
4RC610-H16	80	36	71	4RC520-H77	126	57	71
4RC610-H26	86	39	71	4RC620-H36	106	48	71
4RC630-H67	188	86	76	4RC620-H57	144	65	72

Tightening Torques for Screw Connections

The following values apply if no other information is available.

With non-electrical connections, property classes of 8.8 and 8 or higher as per ISO 898-1 are assumed.

Thread	Tightening torques for non-electrical connections	
	[Nm]	[ft lbs]
M4	2.7 - 3.3	1.99 - 4.44
M5	3.6 - 4.4	2.65 - 3.25
M6	7.2 - 8.8	5.31 - 6.5
M8	21.6 - 26.4	15.9 - 19.5
M10	37.8 - 46.2	27.9 - 34.1
M12	63.0 - 77.0	46.5 - 56.8

The following information for electrical connection applies to all terminal board connections with the exception of terminal strips.

Thread	Tightening torques for electrical connections	
	[Nm]	[ft lbs]
M4	0.8 - 1.2	0.59 - 0.89
M5	1.8 - 2.5	1.33 - 1.84

Especially for metal and plastic threaded cable glands and pipe unions, the following values apply:

Thread	Tightening torques for metal threaded glands/unions	
	[Nm]	[ft lbs]
M12x1.5	4 - 6	2.95 - 4.43
M 16x1.5	5 - 7.5	3.69 - 5.53
M25x1.5	6 - 9	4.43 - 6.64
M32x1.5	8 - 12	5.9 - 8.85
M40x1.5		

Thread	Tightening torques for plastic threaded glands/unions	
	[Nm]	[ft lbs]
M12x1.5	2 - 3.5	1.48 - 2.58
M16x1.5	3 - 4	2.21 - 2.95
M25x1.5	4 - 5	2.95 - 3.69
M32x1.5	5 - 7	3.69 - 5.16
M40x1.5		



Installation

Blower may be lifted manually or utilizing lifting equipment based on the instructions below:

WARNING: Danger from lifting heavy loads. Manual handling of the unit is only permitted within the following limits:

- max. 66 lbs (30 kg) for men
- max. 22 lbs (10 kg) for women
- max. 11 lbs (5 kg) for pregnant women

For the weight of the blower, see Mechanical Data section of this manual. All blowers heavier than the maximums stated above must be lifted using lifting equipment.

1. The blower is ready to connect upon delivery.
2. Install the blower on a level, stable operating surface and use the optional isolation pads to reduce noise and vibration. Attach the included loose muffler if necessary.
3. Have a qualified electrician configure the motor to your incoming voltage as noted in the "Motor Wiring" section of the manual. Refer to the nameplate on the motor for the correct power supply requirements.
4. To ensure sufficient cooling of the blower, it is absolutely necessary that the required minimum distances to the fan guard and the face of the blower cover be maintained. See "Mechanical Data" for minimum distances. Ventilation screens and openings must remain clear. Discharge air of other units may not be directly sucked in again.
5. The blower is suitable for installation within the following ambient conditions: dusty or damp environment, in buildings, in the open (though only if protected from intense sunlight exposure. The blower may be installed within the following conditions: on level surfaces, and at a maximum elevation of 1000 ft. above sea level. (For higher altitudes, contact Republic Manufacturing at 800-847-0380.)
6. Blower may be installed in any vertical/horizontal axis position with one exception: vertically with the blower face pointing upward.
7. From the motor side of the blower, verify the blower is rotating in the direction indicated by the arrow on the motor. (The motor side is marked with an arrow on most models.) Proper rotation can also be checked by the air flow at the inlet and outlet ports. On blowers powered by a 3 phase motor, change the connection of any two (2) wires to reverse blower rotation if needed.

Plumbing & Accessories

1. Remove any foreign material (e.g. burrs, chips, welding drops, pipe cuttings, excess sealant, etc.) from plumbing.
2. Verify the motor is securely mounted and proper blower rotation before connecting to plumbing. The inlet and outlet port are not designed to support the plumbing without proper supporting elements.
3. Remove safety rubber plugs from the inlet and outlet ports.
4. Connect the plumbing with properly sized fittings.
5. Use a relief valve to discharge excess air beyond the preset level on pressure applications. Use a vacuum relief valve to draw in excess air when preset vacuum level is achieved.
6. Install an intake filter to prevent foreign material from entering the blower. In applications where there is high humidity or liquids being used in the process, install a moisture separator with a drain valve.
7. Install two (2) gauges - one before and one after the filter - to monitor differential air flow through the filter element. As filters become clogged, performance efficiency will be reduced. Filters should be checked periodically and replaced when necessary. The recommended check valves provide minimal pressure drop, positive sealing, and are resistant to the high discharge temperatures of the blowers.
8. Recommended piping should be, at minimum, the same size as the inlet and outlet ports on pressure systems.

WARNING: Exhaust air temperature increases significantly above 65" WC (162 mbar). Discharged air is typically too hot for most plastic piping, therefore metal piping is recommended. This piping must be guarded and marked



"DANGER-HOT-DO-NOT TOUCH".

9. Metal piping is recommended for the first 5 ft. (1.5 m) to 8 ft. (2.4 m) from the blower on pressure systems. Elbows increase friction, so elbows should be minimized to decrease friction loss.
10. Pressure or relief valves should be installed in a "T" that is at least one (1) pipe size larger than the port diameter.

Typical Pressure Layout

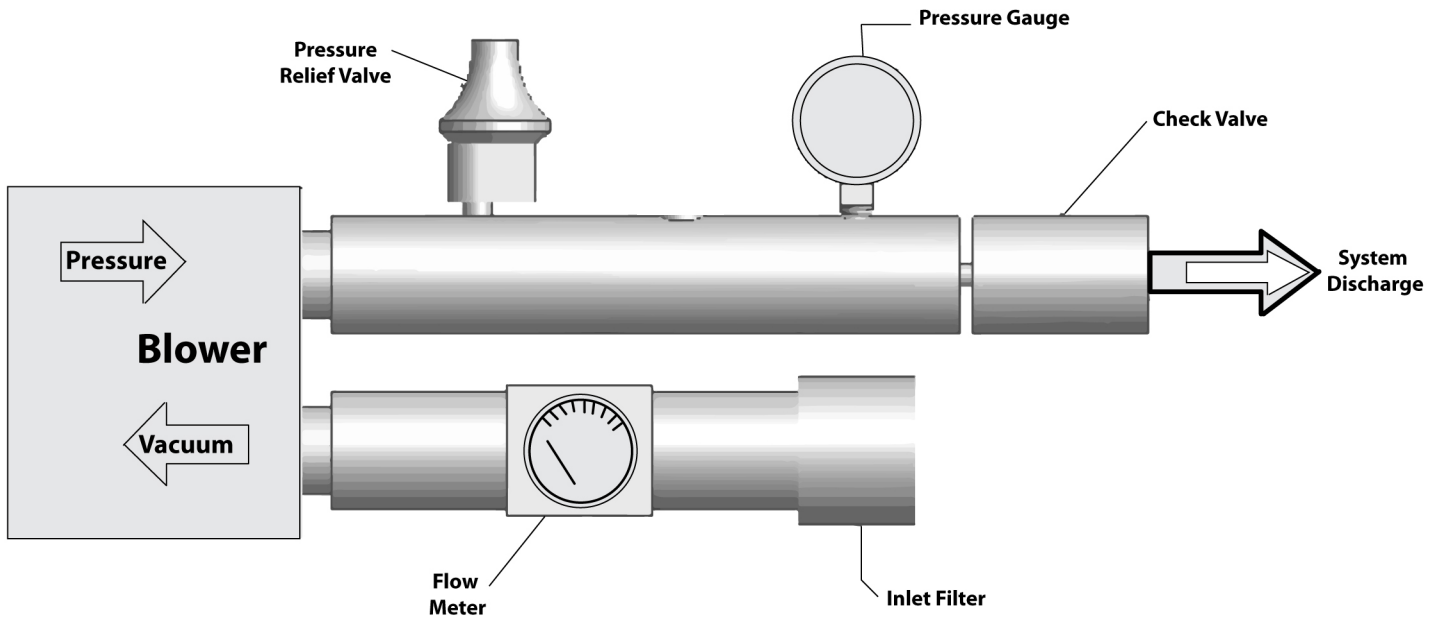

Typical Vacuum Layout

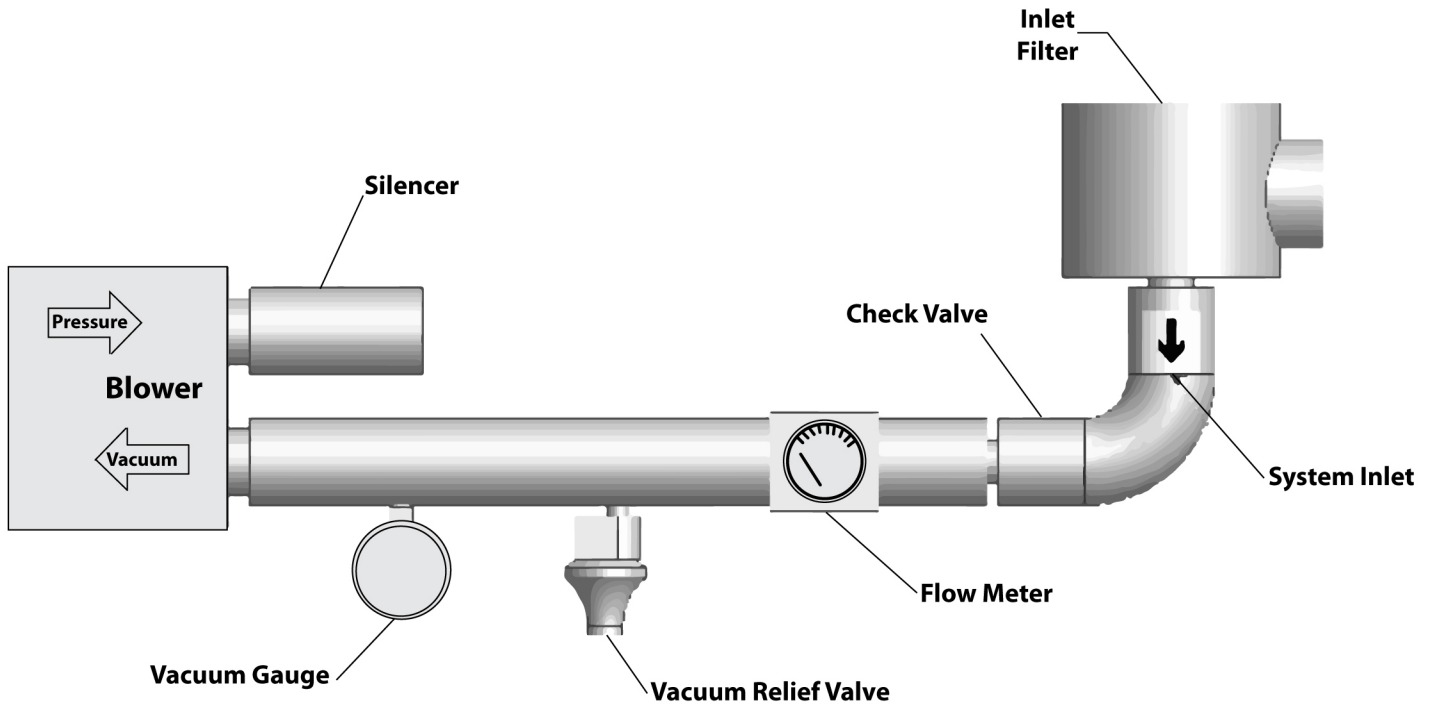



Electrical Connection

 **DANGER:** Malpractice can result in severe injuries and material damage. The electrical connection may be performed by trained and authorized electricians only. Before beginning work on the unit or system, the following measures must be carried out:

- De-energize.
- Perform proper lockout/tagout procedures such that electricity cannot be turned on again.
- Confirm unit is de-energized.
- Ground and short-circuit.
- Cover or block-off adjacent energized parts

 **WARNING:** Incorrect connection of the motor can lead to serious damage to the unit.

- **ELECTRICAL POWER SUPPLY:** Observe the rating plate. It is imperative that the operating conditions correspond to the data given on the rating plate. Deviations permissible without reduction in performance include:
 - +/- 5% voltage deviation
 - +/- 2% frequency deviation
- **CONNECTION TO TERMINAL BOX:** Open the required cable entry openings on the terminal box. Here the following two cases are differentiated:
 - The cable entry opening is prefabricated and provided with a sealing plug.
 - Screw out sealing plug.

OR

- The cable entry opening is closed off with a casting skin (only on blower with drive-motor axis heights of 100" [2.5 m] to 160" [4.0 m] in standard design).
- Break out casting skin using a suitable tool. For example, use a metal pin with a corresponding diameter or a chisel and hammer.
- Mount cable glands on the terminal box. Proceed as follows:
 - Select one cable gland in each case which is suitable for the cable diameter.
 - Insert this cable gland in the opening of the terminal box. Use a reducer if necessary.
 - Screw on the cable gland so that no moisture, dirt, etc. can penetrate into the terminal box.
- Carry out the connection and arrangement of the jumpers in accordance with the wiring diagram in the terminal box or "Wiring Diagram" section of this manual.
- The electrical connection must be carried out as follows:
 - The electrical connection must be permanently safe.
 - **DANGER:** The terminal box must be free from foreign bodies, dirt, and humidity. Terminal box cover and cable entries must be tightly closed so as to make them dust-proof and waterproof. Check for tightness at regular intervals.
 - **DANGER:** There may be no protruding wire ends.
 - **DANGER:** Clearance between bare live parts and between bare live parts and ground : ≥ 0.22 in. (5.5 mm) at a nominal voltage of $U_N \leq 690$ V.
 - For the tightening torques for terminal board connections (except terminal strips), see "Tightening Torques for Screw Connections".
- For motor overload protection, use motor circuit breakers and adjust to the specified nominal current as listed on the rating plate.
- **DANGER:** There is danger of an electrical shock when a defective blower is touched. Mount motor circuit breaker. Have electrical equipment checked regularly by an electrician.

Wiring Diagram - Single Phase

Most Republic single phase regenerative blowers use the wiring diagram shown below. Always follow the wiring diagram on the inside of the blower's terminal box cover. Special versions may exist.

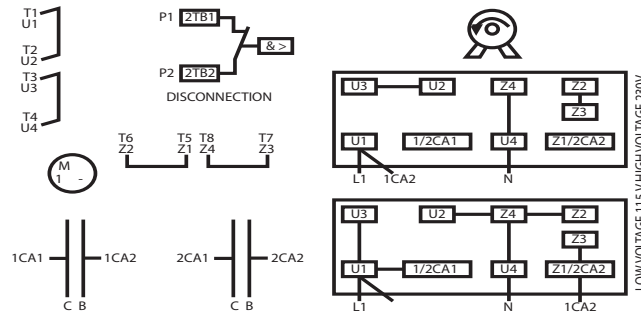

Wiring Diagram - Three Phase

Most Republic three phase regenerative blowers use the wiring diagram show below. Always follow the wiring diagram on the inside of the blower's terminal box cover. Special versions may exist.

The blower data tag located at the top of the motor will match one of these four diagrams below. Each combination of hertz and voltage has a symbol next to it indicating which diagram should be followed for that configuration. Match the symbol next to hertz and voltage to the symbols above the diagram. Once wired, check rotation. If reversed, swap any two leads.

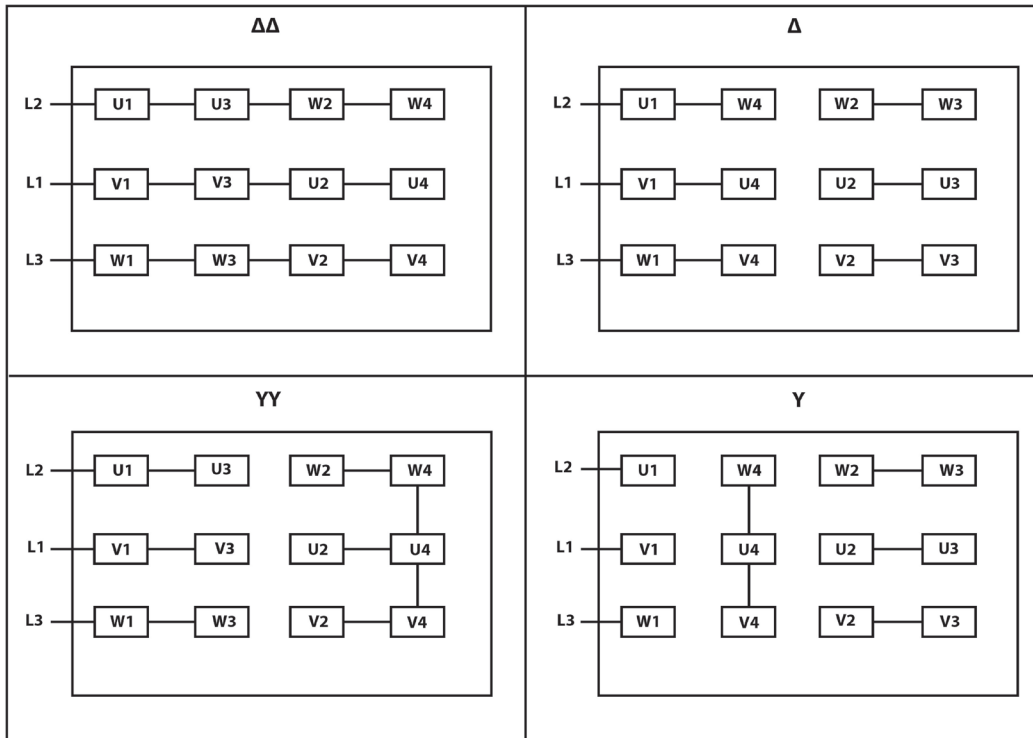

Thermal Leads

Republic regenerative blowers have two small black wires coming from the motor that are not connected to the terminal blocks. These wires are for use with motor over temperature protection features sometimes used in control panels. If a control panel without this feature is used, simply cap off the wires and do not use them.



Commissioning

WARNING: Improper use of the unit can result in serious or even fatal injuries. Do not proceed without reading Safety Instructions.

WARNING: Danger from rotating parts cutting/cutting off of extremities, grasping/winding up of hair and clothing.

WARNING: Danger due to vacuum and pressure, sudden escape of vapor (skin and eye injuries), sudden drawing in of hair and clothing, or burns.

Only start-up and operate under the following conditions:

- The blower must be completely assembled. Pay particular attention to the following components:
 - the blower cover,
 - the muffler on inlet and discharge connections, and
 - the fan guard.
- The pipes/hoses must be connected to inlet and discharge connections.
- Inlet and discharge connections and the connected pipes/hoses may not be closed, clogged or soiled.
- Check the mounting elements, connections of the pipe/hose, lines, fittings and containers for strength, leaks and firm seating at regular intervals.

Preparation

DANGER: Blower can overheat causing damage to the drive motor winding if intake or discharge connections are closed/soiled. Before start-up, make sure the inlet and discharge connections are not closed, clogged or soiled.

CAUTION: Before starting up after a longer standstill: Measure the insulation resistance of the motor. With values ≤ 1 k Ω per volt of nominal voltage, the winding is too dry.

1. Check the direction of the rotation. The intended rotating direction of the shaft is marked with arrows on the housing.
2. The gas delivery direction is marked with arrows on the inlet and discharge connections.
3. Make sure the pipes/hoses on the inlet and discharge connections are properly connected.
4. Switch the blower on briefly and then off again.
5. Compare the actual rotating direction of the external fan with the intended shaft rotating direction indicated with the arrows shortly before the blower comes to a standstill.
6. If necessary, reverse the direction of the rotation of the motor.
7. Observe the operating speed specified on the rating plate. This may not be exceeded, as otherwise the noise radiation, vibration behavior, grease consumption duration and bearing change interval worsen. To prevent damage as a result of higher speeds, it may be necessary to inquire with Republic Manufacturing as to the maximum speed.

Start-Up

1. Open shut-off device in intake/discharge pipe.
2. Switch on power supply for drive motor.
3. Operate blower for an hour, and then check:
 - Ambient temperature - increased room temperatures may require stronger ventilation especially for larger blowers. Room temperature should not exceed 104 (40°C).
 - Pressure and vacuum valves - adjust relief valve pressure or vacuum setting if needed.
 - Motor current - check that current supply matches recommended current rating on blower nameplate.
 - Electrical overload cutout - check that current matches rating on blower nameplate

If motor fails to start or slows down significantly under load, shut off and disconnect from power supply. Check that the voltage is correct for the motor and that the motor is turning in the proper direction.

Shut-Down

1. Switch off power supply for drive motor.
2. Close shut-off device in intake/discharge pipe, if applicable.

Operation

WARNING: Improper use of the unit can result in serious or even fatal injuries. Do not proceed without reading Safety Instructions.

WARNING: Danger due to vacuum and pressure, sudden escape of vapors (skin and eye injuries), sudden drawing in of hair and clothing.

WARNING: Danger of overheating due to hot surface of blower. High temperatures of up to approximately 320°F (160°C) can occur on the surface of the blower. Do not touch during operation. Allow to cool after shut-down.

CAUTION: Danger of overheating due to hot surface of blower. Temperature sensitive parts, such as lines or electronic components, may not come into contact with the surface of the blower.

CAUTION: Danger of rusting due to collection of condensed water in drive motor area. On drive motors with closed condensed water openings, remove closures occasionally to allow any water which has collected to drain off.

CAUTION: Danger of bearing damage. Heavy mechanical impacts must be avoided during operating and while at standstill.

Shut-Down & Longer Standstills

Preparing for shut-down or longer standstill

WARNING: Improper use of the unit can result in serious or even fatal injuries. Do not proceed without reading "Safety Instructions".

CAUTION: Danger of rusting due to collection of condensed water in drive motor area. On drive motors with closed condensed water openings, remove closures occasionally to allow any water which has collected to drain off.

CAUTION: Danger of bearing damage. Heavy mechanical impacts must be avoided during operating and while at standstill.

Prior to shut-down or longer standstill, proceed as follows:

1. Switch off the blower.
2. Close shut-off device in inlet and pressure line if installed.
3. Disconnect blower from power supply.
4. Release pressure. Open pipes/hoses slowly and carefully so that the vacuum or gauge pressure in the blower can be released.
5. Remove pipes/hoses.
6. Provide mufflers on inlet and discharge side with sealing plugs.

Servicing

WARNING: Improper use of the unit can result in serious or even fatal injuries. Do not proceed without reading "Safety Instructions".

Emptying/Rinsing/Cleaning

Before any maintenance/servicing work, empty, rinse and clean the outside of the unit.

1. Empty unit with air and rinse until all residues have been removed.
2. Clean the outside of the unit with compressed air.
 - Wear gloves and protective safety glasses.
 - Secure the surrounding area.
 - Clean the entire surface of the unit and exterior fan with compressed air.

Preventative Maintenance

After the first 100 hours of operation, the following need to be checked:

- filter elements;
- noise absorbing foam in mufflers; and
- motor and blower cleanliness.

Replace filter elements as needed. Mufflers should be checked on a monthly basis.



Allowable Number of Starts and Minimum Time Between Starts for NEMA Design A & Design B Motors

HP	2 Pole			4 Pole			6 Pole		
	A	B	C	A	B	C	A	B	C
1	15	1.2	75	30	5.8	38	34	15	33
1.5	12.9	1.8	76	25.7	8.6	38	29.1	23	34
2	11.5	2.4	77	23	11	39	26.1	30	35
3	9.9	3.5	80	19.8	17	40	22.4	44	36
5	8.1	5.7	83	16.3	27	42	18.4	71	37
7.5	7	8.3	88	13.9	39	44	15.8	104	39
10	6.2	11	92	12.5	51	46	14.2	137	41
15	5.4	16	100	10.7	75	50	12.1	200	44
10	4.8	21	110	9.6	99	55	10.9	262	48
25	4.4	26	115	8.8	122	58	10	324	51
30	4.1	31	120	8.2	144	60	9.3	384	53
40	3.7	40	130	7.4	189	65	8.4	503	57

Where:

A= Maximum number of starts per hour

B= Maximum product of starts per hour times load WK² (Note this is also maximum allowable inertia per NEMA)

C= Minimum rest or off time in seconds between starts

Allowable starts per hour is the lesser of A or B divided by the load WK² or

$$\text{Starts per hour} < A < \frac{B}{\text{Load Wk}^2}$$

Note- The above table is based on the following conditions:

- a. Applied voltage and frequency are in accordance in MG1, 12.44
- b. During the acceleration period, the connected load torque is equal to or less than a torque which varies as the square of the speed and is equal to 100% of rated torque at rated speed. (e.g. a variable torque load)
- c. External load WK² is equal to or less than the values listed in MG1, 12.54

For conditions which exceed the above parameters, Republic Manufacturing should be consulted

Troubleshooting

Problem	Reason	Remedy
Increased sound	Noise absorbing foam is damaged	Replace foam.
	Impeller rubbing inside	Send unit to Republic Authorized Repair Facility.
Excessive vibration	Damaged impeller	Replace impeller.
	Motor and/or impeller are dirty	Clean motor and impeller periodically.
Ambient and exhaust temperature increases	Motor and/or blower are dirty	Clean motor and blower periodically.
	Filters are dirty	Replace filters.
Decreased inlet air pressure	Inlet air filter is clogged	Clean inlet filter or replace cartridge.
Unit is very hot	Wrong wiring	Check wiring.
	Low voltage	Supply proper voltage.
	Inlet air filter is clogged	Clean inlet filter.
	Motor and/or blower are dirty	Replace cartridge.
	Operating pressure or vacuum is too high	Clean motor and blower periodically. Install a relief valve and pressure or vacuum gauge.
Unusual sound	Impeller is damaged or dirty	Clean or replace impeller.
	Bearing failure	Send unit to Republic Authorized Repair Facility.
	Flow speed is too high	Clean pipes. Use pipe with larger cross-section if necessary.
	Muffler is dirty	Clean or replace muffler inserts.
Motor overload	Low voltage	Check power source.
		Check wire size and wire connections.
Unit does not start	Incorrect electrical connection or power source	Check wiring diagram, circuit fusing and circuit capacity.
	Impeller is damaged	Clean or replace impeller.
		Install proper filtration.
Blower does not generate any or generates insufficient pressure difference	Leak in system	Seal leak in system.
	Wrong direction of rotation	Reverse direction of rotation by interchanging two connecting leads.
	Incorrect frequency	Correct frequency.
	Shaft seal defective	Replace shaft seal.
	Different density of pumped gas	Take conversion of pressure values into account. Inquire with Republic Manufacturing.
	Impeller is damaged	Clean or replace impeller.
Blower leaking	Seals on muffler are defective	Check muffler seals and replace if necessary.
	Seals in motor area are defective	Check motor seals and replace if necessary.



In the Event of a Breakdown

1. Use a lockout/tagout procedure to ensure the blower may be worked on safely.
2. Refer to the “Troubleshooting” section of the manual to determine the cause of the breakdown and the appropriate action to take.
3. If further assistance is needed, please call Republic Manufacturing at 800-847-0380.

When to Ship the Blower Back to Republic

If you cannot fix or troubleshoot your blower system using this manual then a skilled Republic Manufacturing professional is required. Please ship your blower back to Republic Manufacturing.

Disabling, Dismantling, and Scrapping of Blower

1. Disable the blower using the lockout/tagout procedure outlined in the manual.
2. Scrap entire unit using a suitable disposal company.
3. Most components are aluminum, stainless steel, or zinc-plated mild steel and may be recycled or disposed of as such.

Warranty Terms and Conditions

Republic Manufacturing warrants all finished Republic Manufacturing products to be free from functional defects in material and workmanship for a period of twelve (12) months from the date of installation, or no longer than eighteen (18) months from shipment.

Wear parts such as filter elements, hoses and piping are not covered by the 12 to 18 month warranty.

DISASSEMBLY OF BLOWER MAY VOID WARRANTY.

To obtain service within the warranty period, first contact your authorized Republic Manufacturing dealer or Republic Manufacturing Service Department. Republic’s responsibility under this warranty shall be to provide an analysis of the blower, which will determine course of action. Any product found to be defective within the warranty period will merit either:

- a. A no charge repair of existing blower. Any freight charges will be the purchaser’s responsibility.
- b. A replacement blower*. Any freight charges will be the purchaser’s responsibility.

*This option would be a chargeable replacement until the original blower is received by Republic Manufacturing, and warranty is approved.

Republic Manufacturing shall not be liable for incidental nor consequential damages resulting from the use of this product. There are no expressed nor implied warranties, which extend beyond the warranty of merchantability or fitness for a particular purpose to the equipment and/or its parts and components.

Exploded View

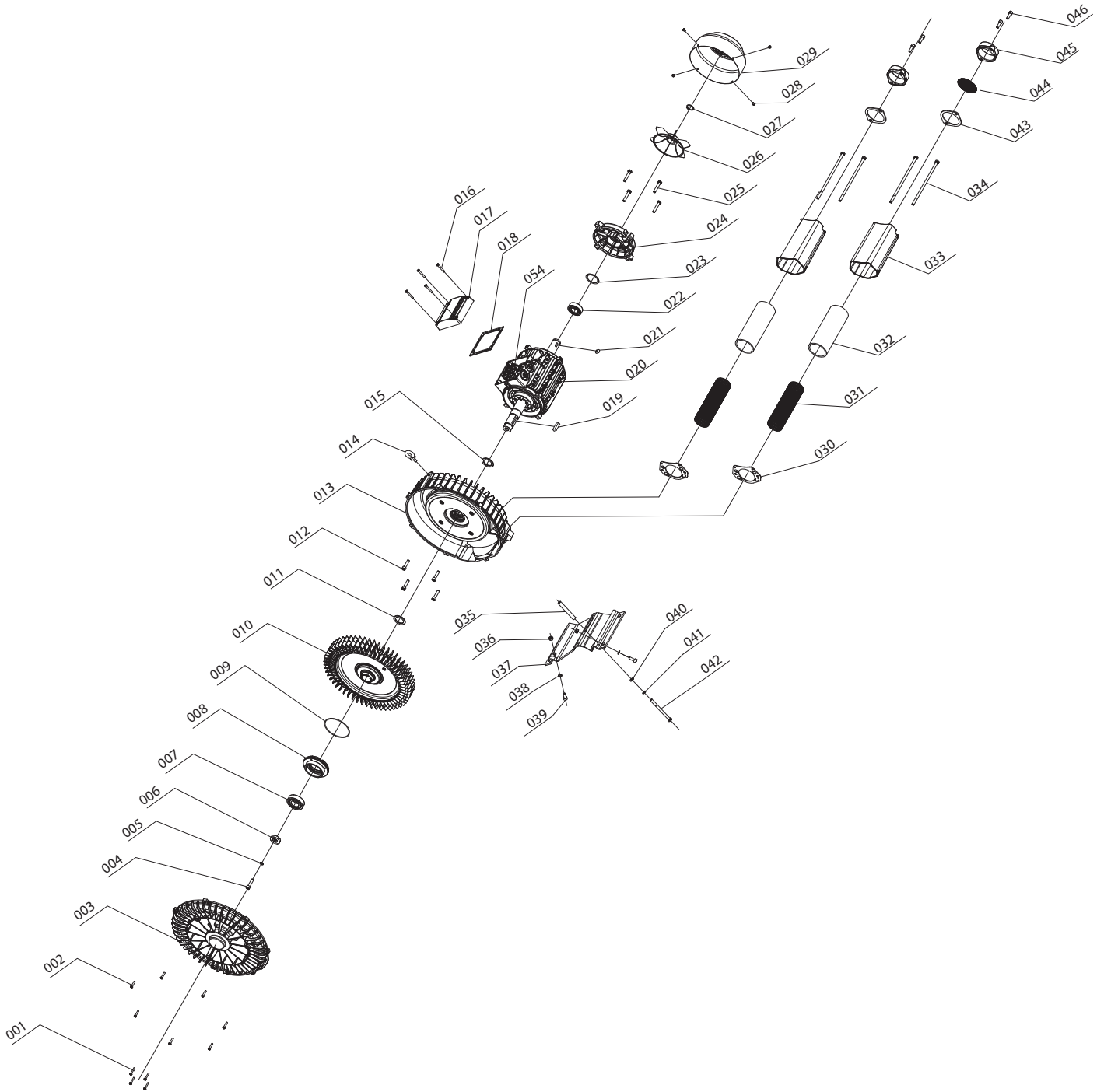



4RC-210

Position No.	Description	4RC210-H16	4RC210-A75
003	Front Cover	3035700	3035700
007	Front bearing	3071800	3071800
008	Bearing cover	3081800	3081800
009	O-Ring	3095700	3095700
010	Impeller	3105700	3105700
013	Housing	3135700	3135700
015	Shaft lip seal	3155700	3155700
017	Junction box cover	3170100	3170100
018	Junction box gasket	3180100	3180100
019	Key	3191800	3191800
021	Rotor	3215700	3215800
022	Rear bearing	3220100	3220100
024	Motor cover	3240100	3240100
026	External fan	3260100	3260100
027	Retaining ring	3270100	3270100
029	Fan cowl	3290100	3290100
030	Gasket	3300100	3300100
031/032/033/034	Silencer Assembly	3500100	3500100
031	Silencer insert	3310100	3310100
032	Silencer inlet filter	3320100	3320100
033	Silencer housing	3330100	3330100
034	Silencer Bolts	3340100	3340100
043	Flange gasket	3430100	3430100
045	Flange	3450100	3450100
053	Capacitor	N/A	Contact Republic
054	Terminal Block	3540106/3540112	3540106/3540112

4RC-310

Position No.	Description	4RC310-H16	4RC310-H26	4RC310-A71
003	Front Cover	3036200	3036200	3036200
007	Front bearing	3071800	3071800	3071800
008	Bearing cover	3081800	3081800	3081800
009	O-Ring	3095700	3095700	3095700
010	Impeller	3106200	3106200	3106200
013	Housing	3136200	3136200	3136200
015	Shaft lip seal	3155700	3155700	3155700
017	Junction box cover	3170100	3170100	3170100
018	Junction box gasket	3180100	3180100	3180100
019	Key	3191800	3191800	3191800
021	Rotor	3216200	3216300	3216400
022	Rear bearing	3220100	3226000	3226000
024	Motor cover	3240100	3240900	3240900
026	External fan	3260100	3260900	3260900
027	Retaining ring	3270100	3270900	3270900
029	Fan cowl	3290100	3290100	3290900
030	Gasket	3300100	3300100	3300100
031/032/033/034	Silencer Assembly	3500100	3500100	3500100
031	Silencer insert	3310100	3310100	3310100
032	Silencer inlet filter	3320100	3320100	3320100
033	Silencer housing	3330100	3330100	3330100
034	Silencer bolts	3340100	3340100	3340100
043	Flange gasket	3430100	3430100	3430100
045	Flange	3450100	3450100	3450100
053	Capacitor	N/A	N/A	Contact Republic
054	Terminal Block	3540106/3540112	3540106/3540112	3540106/3540112



4RC-410

Position No.	Description	4RC410-H16	4RC410-A41
003	Front Cover	3036800	3036800
007	Front bearing	3071800	3071800
008	Bearing cover	3081800	3081800
009	O-Ring	3095700	3095700
010	Impeller	3106800	3106800
013	Housing	3136800	3136800
015	Shaft lip seal	3155700	3155700
017	Junction box cover	3170100	3170100
018	Junction box gasket	3180100	3180100
019	Key	3191800	3191800
021	Rotor	3216800	3216900
022	Rear bearing	3226000	3226000
024	Motor cover	3240900	3240900
026	External fan	3260900	3260900
027	Retaining ring	3270900	3270900
029	Fan cowl	3290900	3290900
030	Gasket	3300100	3300100
031/032/033/034	Silencer Assembly	3500100	3500100
031	Silencer insert	3310100	3310100
032	Silencer inlet filter	3320100	3320100
033	Silencer housing	3330100	3330100
034	Silencer bolts	3340100	3340100
043	Flange gasket	3430100	3430100
045	Flange	3450100	3450100
053	Capacitor	N/A	3533000
054	Terminal Block	3540106/3540112	3540106/3540112

4RC-510

Position No.	Description	4RC510-H16	4RC510-H26
003	Front Cover	3037200	3037200
007	Front bearing	3072900	3072900
008	Bearing cover	3082900	3082900
009	O-Ring	3092900	3092900
010	Impeller	3107200	3107200
013	Housing	3137200	3137200
015	Shaft lip seal	3157200	3157200
017	Junction box cover	3170100	3170100
018	Junction box gasket	3180100	3180100
019	Key	3192900	3192900
021	Rotor	3217200	3217300
022	Rear bearing	3226000	3226000
024	Motor cover	3241800	3241800
026	External fan	3261800	3261800
027	Retaining ring	3271500	3271500
029	Fan cowl	3291800	3292400
030	Gasket	3300100	3300100
031/032/033/034	Silencer Assembly	3500100	3500100
031	Silencer insert	3310100	3310100
032	Silencer inlet filter	3320100	3320100
033	Silencer housing	3330100	3330100
034	Silencer bolts	3340100	3340100
043	Flange gasket	3430100	3430100
045	Flange	3450100	3450100
054	Terminal Block	3540106/3540112	3540106/3540112



4RC-610

Position No.	Description	4RC610-H16	4RC610-H26
003	Front Cover	3037600	3037600
007	Front bearing	3072900	3072900
008	Bearing cover	3082900	3082900
009	O-Ring	3095700	3095700
010	Impeller	3107600	3107600
013	Housing	3137600	3137600
015	Shaft lip seal	3157200	3157200
017	Junction box cover	3170100	3170100
018	Junction box gasket	3180100	3180100
019	Key	3192900	3192900
021	Rotor	3217600	3217700
022	Rear bearing	3226000	3222100
024	Motor cover	3241800	3242500
026	External fan	3261800	3263100
027	Retaining ring	3271500	3273100
029	Fan cowl	3292400	3292400
030	Gasket	3300100	3300100
031/032/033/034	Silencer Assembly	3500100	3500100
031	Silencer insert	3310100	3310100
032	Silencer inlet filter	3320100	3320100
033	Silencer housing	3330100	3330100
034	Silencer bolts	3340100	3340100
043	Flange gasket	3430100	3430100
045	Flange	3450100	3450100
054	Terminal Block	3540106/3540112	3543106/3543112

HRC-025/025-1

Position No.	Description	HRC025	HRC025-1
003	Front Cover	3030100	3030100
007	Front bearing	3070100	3070100
008	Bearing cover	3080100	3080100
009	O-Ring	N/A	N/A
010	Impeller	3100100	3100100
013	Housing	3130100	3130100
015	Shaft lip seal	3150100	3150100
017	Junction box cover	3170100	3170100
018	Junction box gasket	3180100	318000
019	Key	3190100	3190100
021	Rotor	3210100	3210200
022	Rear bearing	3220100	3220100
024	Motor cover	3240100	3240100
026	External fan	3260100	3260100
027	Retaining ring	3270100	3270100
029	Fan cowl	3290100	3290100
030	Gasket	3300100	3300100
031/032/033/034	Silencer Assembly	3500100	3500100
031	Silencer insert	3310100	3310100
032	Silencer inlet filter	3320100	3320100
033	Silencer housing	3330100	3330100
034	Silencer bolts	3340100	3340100
043	Flange gasket	3430100	3430100
045	Flange	3450100	3450100
053	Capacitor	N/A	Contact Republic
054	Terminal Block	3540106/3540112	3540106/3540112



HRC-100/101

Position No.	Description	HRC100	HRC101
003	Front Cover	3030300	3030300
007	Front bearing	3070100	3070100
008	Bearing cover	3080100	3080100
009	O-Ring	N/A	N/A
010	Impeller	3100100	3100100
013	Housing	3130300	3130300
015	Shaft lip seal	3150100	3150100
017	Junction box cover	3170100	3170100
018	Junction box gasket	3180100	3180100
019	Key	3190100	3190100
021	Rotor	3210300	3210400
022	Rear bearing	3220100	3220100
024	Motor cover	3240100	3240100
026	External fan	3260100	3260100
027	Retaining ring	3270100	3270100
029	Fan cowl	3290100	3290100
030	Gasket	3300100	3300100
031/032/033/034	Silencer Assembly	3500100	3500100
031	Silencer insert	3310100	3310100
032	Silencer inlet filter	3320100	3320100
033	Silencer housing	3330100	3330100
034	Silencer bolts	3340100	3340100
043	Flange gasket	3430100	3430100
045	Flange	3450100	3450100
053	Capacitor	N/A	Contact Republic
054	Terminal Block	3540106/3540112	3540106/3540112

HRC-200/201

Position No.	Description	HRC200	HRC201
003	Front Cover	3031100	3031100
007	Front bearing	3071100	3071100
008	Bearing cover	3081100	3081100
009	O-Ring	N/A	N/A
010	Impeller	3101100	3101100
013	Housing	3131100	3131100
015	Shaft lip seal	3151100	3151100
017	Junction box cover	3170100	3170100
018	Junction box gasket	3180100	3180100
019	Key	3191100	3191100
021	Rotor	3211100	3211200
022	Rear bearing	3220100	3220100
024	Motor cover	3240100	3240100
026	External fan	3260100	3260100
027	Retaining ring	3270100	3270100
029	Fan cowl	3290100	3290100
030	Gasket	3301100	3301100
031/032/033/034	Silencer Assembly	3501100	3501100
031	Silencer insert	3311100	3311100
032	Silencer inlet filter	3321100	3321100
033	Silencer housing	3331100	3331100
034	Silencer bolts	3341100	3341100
043	Flange gasket	3431100	3431100
045	Flange	3451100	3451100
053	Capacitor	N/A	3531200
054	Terminal Block	3540106/3540112	3540106/3540112



HRC-300/301/400/401

Position No.	Description	HRC300	HRC301	HRC400	HRC401
003	Front Cover	3031800	3031800	3031800	3031800
007	Front bearing	3071800	3071800	3071800	3071800
008	Bearing cover	3081800	3081800	3081800	3081800
009	O-Ring	N/A	N/A	N/A	N/A
010	Impeller	3101800	3101800	3101800	3101800
013	Housing	3131800	3131800	3131800	3131800
015	Shaft lip seal	3151800	3151800	3151800	3151800
017	Junction box cover	3170100	3170100	3170100	3170100
018	Junction box gasket	3180100	3180100	3180100	3180100
019	Key	3191800	3191800	3191800	3191800
021	Rotor	3211800	3211900	3212000	3212100
022	Rear bearing	3221800	3221800	3221800	3222100
024	Motor cover	3241800	3241800	3241800	3241800
026	External fan	3261800	3261800	3261800	3261800
027	Retaining ring	3271500	3271500	3271500	3271500
029	Fan cowl	3291800	3291800	3292400	3291800
030	Gasket	3301800	3301800	3301800	3301800
031/032/033/034	Silencer Assembly	3501800	3501800	3501800	3501800
031	Silencer insert	3311800	3311800	3311800	3311800
032	Silencer inlet filter	3321800	3321800	3321800	3321800
033	Silencer housing	3331800	3331800	3331800	3331800
034	Silencer bolts	3341800	3341800	3341800	3341800
043	Flange gasket	3431800	3431800	3431800	3431800
045	Flange	3451800	3451800	3451800	3451800
053	Capacitor	N/A	Contact Republic	N/A	Contact Republic
054	Terminal Block	3540106/3540112	3540106/3540112	3540106/3540112	3540106/3540112

HRC-500/501/600/700

Position No.	Description	HRC500	HRC501	HRC600	HRC700
003	Front Cover	3032900	3032900	3032900	3032900
007	Front bearing	3072900	3072900	3072900	3072900
008	Bearing cover	3082900	3082900	3082900	3082900
009	O-Ring	3092900	3092900	3092900	3092900
010	Impeller	3102900	3102900	3102900	3102900
013	Housing	3132900	3132900	3132900	3132900
015	Shaft lip seal	3152000	3152000	3152000	3152000
017	Junction box cover	3170100	3170100	3173100	3173100
018	Junction box gasket	3180100	3180100	3183100	3183100
019	Key	3192900	3192900	3192900	3192900
021	Rotor	3212900	3213000	3213100	3213200
022	Rear bearing	3221800	3222100	3223100	3223100
024	Motor cover	3241800	3241800	3242500	3242500
026	External fan	3261800	3261800	3263100	3263100
027	Retaining ring	3271500	3271500	3273100	3273100
029	Fan cowl	3292400	3292400	3292900	3292900
030	Gasket	3301800	3301800	3301800	3301800
031/032/033/034	Silencer Assembly	3501800	3501800	3501800	3501800
031	Silencer insert	3311800	3311800	3311800	3311800
032	Silencer inlet filter	3321800	3321800	3321800	3321800
033	Silencer housing	3331800	3331800	3331800	3331800
034	Silencer bolts	3341800	3341800	3341800	3341800
043	Flange gasket	3431800	3431800	3431800	3431800
045	Flange	3451800	3451800	3451800	3451800
053	Capacitor	N/A	3533000	N/A	N/A
054	Terminal Block	3540106/3540112	3540106/3540112	3543106/3543112	3543106/3543112



HRC-750/800/900/1000

Position No.	Description	HRC750	HRC800	HRC900	HRC1000
003	Front Cover	3033900	3033900	3033900	3033900
007	Front bearing	3073900	3073900	3073900	3073900
008	Bearing cover	3083900	3083900	3083900	3083900
009	O-Ring	3093900	3093900	3093900	3093900
010	Impeller	3103900	3103900	3103900	3103900
013	Housing	3133900	3133900	3133900	3133900
015	Shaft lip seal	3154200	3154200	3154200	3154200
017	Junction box cover	3173100	3174000	3174000	3174000
018	Junction box gasket	3184000	3184000	3184000	3184000
019	Key	3193900	3193900	3193900	3193900
021	Rotor	3213900	3214000	3214100	3218100
022	Rear bearing	3223100	3224000	3224000	3224900
024	Motor cover	3242500	3243500	3243500	3243500
026	External fan	3263100	3264000	3264000	3264000
027	Retaining ring	3273100	3274000	3274000	3274000
029	Fan cowl	3293900	3294400	3294400	3294400
030	Gasket	3303900	3303900	3303900	3303900
031/032/033/034	Silencer Assembly	3503900	3503900	3503900	3503900
031	Silencer insert	3313900	3313900	3313900	3313900
032	Silencer inlet filter	3323900	3323900	3323900	3323900
033	Silencer housing	3334400	3334400	3334400	3334400
034	Silencer bolts	3344400	3344400	3344400	3344400
043	Flange gasket	3434400	3434400	3434400	3434400
045	Flange	3454400	3454400	3454400	3454400
054	Terminal Block	3543106/3543112	3544006/3544012	3544006/3544012	3544006/3544012

HRC-1020/1040/1060

Position No.	Description	HRC1020	HRC1040	HRC1060
003	Front Cover	3033900	3033900	3033900
007	Front bearing	3073900	3073900	3073900
008	Bearing cover	3083900	3083900	3083900
009	O-Ring	3093900	3093900	3093900
010	Impeller	3104400	3104400	3104400
013	Housing	3134400	3134400	3134400
015	Shaft lip seal	3154200	3154200	3154200
017	Junction box cover	3173100	3174000	3174000
018	Junction box gasket	3183100	3184000	3184000
019	Key	3193900	3193900	3193900
021	Rotor	3214400	3214500	3214600
022	Rear bearing	3223100	3224000	3224000
024	Motor cover	3242500	3243500	3243500
026	External fan	3263100	3264000	3264000
027	Retaining ring	3273100	3274000	3274000
029	Fan cowl	3293900	3294400	3294400
030	Gasket	3303900	3303900	3303900
031/032/033/034	Silencer Assembly	3503900	3503900	3503900
031	Silencer insert	3313900	3313900	3313900
032	Silencer inlet filter	3323900	3323900	3323900
033	Silencer housing	3334400	3334400	3334400
034	Silencer bolts	3344400	3344400	3344400
043	Flange gasket	3434400	3434400	3434400
045	Flange	3454400	3454400	3454400
054	Terminal Block	3543106/3543112	3544006/3544012	3544006/3544012



HRC-1100/1200/1300

Position No.	Description	HRC1100	HRC1200	HRC1300
003	Front Cover	3034800	3034800	3034800
007	Front bearing	3074800	3074800	3074800
008	Bearing cover	3084800	3084800	3084800
009	O-Ring	3093900	3093900	3093900
010	Impeller	3104800	3104800	3104800
013	Housing	3134800	3134800	3134800
015	Shaft lip seal	3154800	3154800	3154800
017	Junction box cover	3174000	3174900	3174900
018	Junction box gasket	3184000	3184900	3184900
019	Key	3194800	3194800	3194800
021	Rotor	3214800	3214900	3215000
022	Rear bearing	3224000	3224900	3224900
024	Motor cover	3243500	3244200	3244200
026	External fan	3264000	3264900	3264900
027	Retaining ring	3274000	3274900	3274900
029	Fan cowl	3294400	3294800	3294800
030	Gasket	3304900	3304900	3304900
031/032/033/034	Silencer Assembly	3504800	3504800	3504800
031	Silencer insert	3314800	3314800	3314800
032	Silencer inlet filter	3324800	3324800	3324800
033	Silencer housing	3334800	3334800	3334800
034	Silencer bolts	3344800	3344800	3344800
043	Flange gasket	3434800	3434800	3434800
045	Flange	3454800	3454800	3454800
054	Terminal Block	3544006/3544012	3544006/3544012	3544006/3544012

Republic Regenerative Blower Exploded View Double Stage Blowers

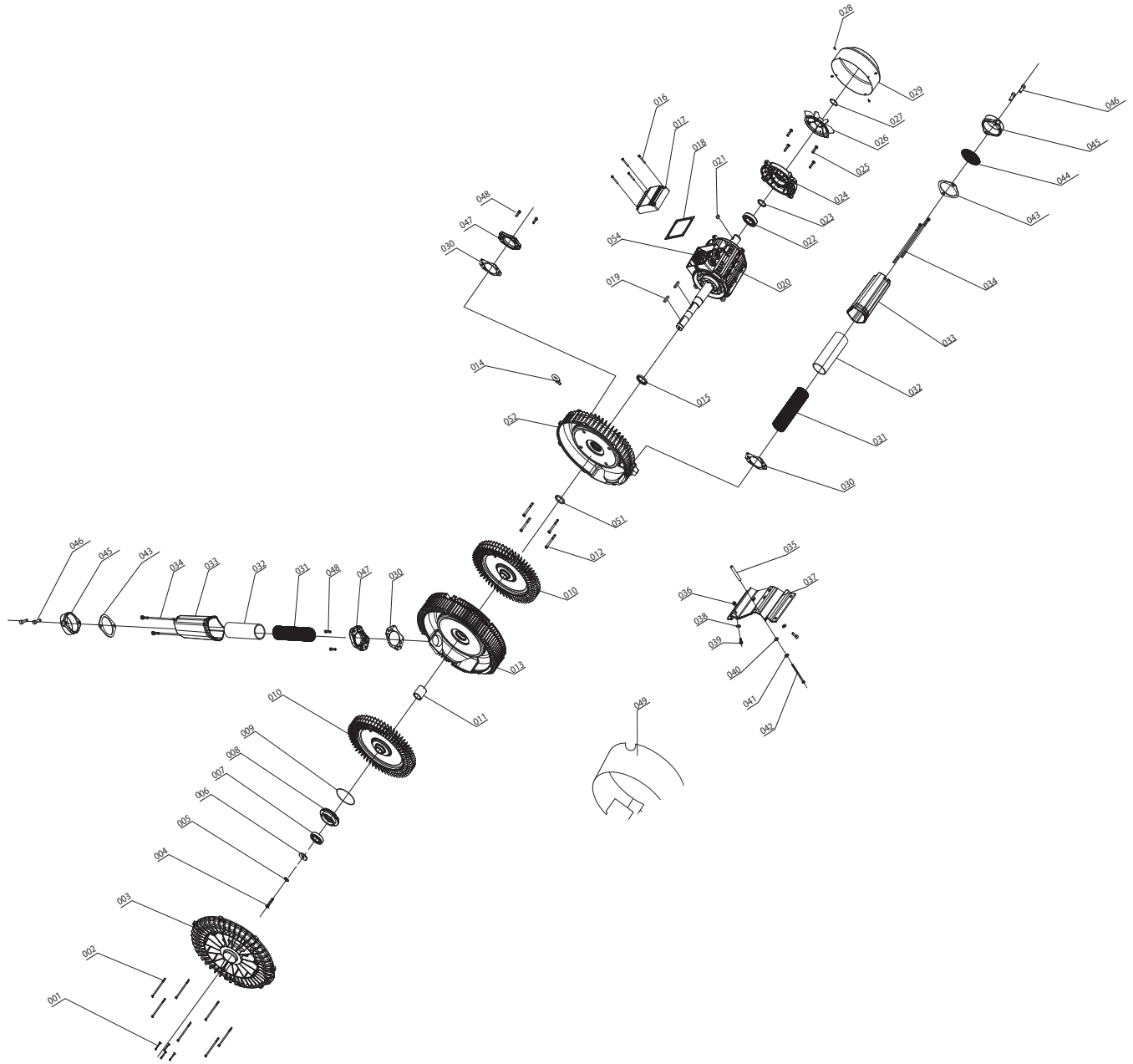



4RC-220

Position No.	Description	4RC220-H26	4RC220-H56	4RC220-A75
003	Front Cover	3035700	3035700	3035700
007	Front bearing	3071800	3071800	3071800
008	Bearing cover	3081800	3081800	3081800
009	O-Ring	3095700	3095700	3095700
010	Impeller	3105700	3105700	3105700
013	Housing	3135900	3135900	3135900
015	Shaft lip seal	3152000	3152000	3152000
017	Junction box cover	3170100	3170100	3170100
018	Junction box gasket	3180100	3180100	3180100
019	Key	3191800	3191800	3191800
021	Rotor	3215900	3216000	3216100
022	Rear bearing	3220100	3226000	3222100
024	Motor cover	3240900	3241800	3241800
026	External fan	3260100	3261800	3261800
027	Retaining ring	3270900	3271500	3271500
029	Fan cowl	3290900	3291800	3291800
030	Gasket	3300100	3301000	3300100
031/032/033/034	Silencer Assembly	3500100	3500100	3500100
031	Silencer insert	3310100	3310100	3310100
032	Silencer inlet filter	3320100	3320100	3320100
033	Silencer housing	3330100	3330100	3330100
034	Silencer bolts	3340100	3340100	3340100
043	Flange gasket	3430100	3430100	3430100
045	Flange	3450100	3450100	3450100
049	Shroud	3495700	3495700	3495700
051	Seal	3515700	3515700	3515700
052	Channel	3525900	3525900	3525900
053	Capacitor	N/A	N/A	Contact Republic
054	Terminal Block	3540106/3540112	3540106/3540112	3540106/3540112

4RC-320

Position No.	Description	4RC320-H46	4RC320-H56	4RC320-A75
003	Front Cover	3036200	3036200	3036200
007	Front bearing	3071800	3071800	3071800
008	Bearing cover	3081800	3081800	3081800
009	O-Ring	3095700	3095700	3095700
010	Impeller	3106200	3106200	3106200
013	Housing	3136500	3136500	3136500
015	Shaft lip seal	3152000	3152000	3152000
017	Junction box cover	3170100	3170100	3170100
018	Junction box gasket	3180100	3180100	3180100
019	Key	3191800	3191800	3191800
021	Rotor	3216500	3216600	3216700
022	Rear bearing	3226000	3226000	3222100
024	Motor cover	3240900	3241800	3241800
026	External fan	3260900	3261800	3261800
027	Retaining ring	3270900	3271500	3271500
029	Fan cowl	3290900	3291800	3291800
030	Gasket	3300100	3300100	3300100
031/032/033/034	Silencer Assembly	3500100	3500100	3500100
031	Silencer insert	3310100	3310100	3310100
032	Silencer inlet filter	3320100	3320100	3320100
033	Silencer housing	3330100	3330100	3330100
034	Silencer bolts	3340100	3340100	3340100
043	Flange gasket	3430100	3430100	3430100
045	Flange	3450100	3450100	3450100
049	Shroud	3496200	3496200	3496200
051	Seal	3516200	3516200	3516200
052	Channel	3526500	3526500	3526500
053	Capacitor	N/A	N/A	Contact Republic
054	Terminal Block	3540106/3540112	3540106/3540112	3540106/3540112



4RC-420

Position No.	Description	4RC420-H26	4RC420-H56
003	Front Cover	3036800	3036800
007	Front bearing	3071800	3071800
008	Bearing cover	3081800	3081800
009	O-Ring	3095700	3095700
010	Impeller	3106800	3106800
013	Housing	3137000	3137000
015	Shaft lip seal	3152000	3152000
017	Junction box cover	3170100	3170100
018	Junction box gasket	3180100	3180100
019	Key	3191800	3191800
021	Rotor	3217000	3217100
022	Rear bearing	3226000	3222100
024	Motor cover	3241800	3242500
026	External fan	3261800	3263100
027	Retaining ring	3271500	3273100
029	Fan cowl	3291800	3292400
030	Gasket	3300100	3300100
031/032/033/034	Silencer Assembly	3500100	3500100
031	Silencer insert	3310100	3310100
032	Silencer inlet filter	3320100	3320100
033	Silencer housing	3330100	3330100
034	Silencer bolts	3340100	3340100
043	Flange gasket	3430100	3430100
045	Flange	3450100	3450100
049	Shroud	3496800	3496800
051	Seal	3516800	3516800
052	Channel	3527000	3527000
054	Terminal Block	3540106/3540112	3543106/3543112

4RC-520

Position No.	Description	4RC520-H26	4RC520-H77
003	Front Cover	3037200	3037200
007	Front bearing	3072900	3072900
008	Bearing cover	3082900	3082900
009	O-Ring	3092900	3092900
010	Impeller	3107200	3107200
013	Housing	3137400	3137400
015	Shaft lip seal	3157600	3157600
017	Junction box cover	3170100	3173100
018	Junction box gasket	3180100	3183100
019	Key	3192900	3192900
021	Rotor	3217400	3217500
022	Rear bearing	3226000	3223100
024	Motor cover	3241800	3242500
026	External fan	3261800	3263100
027	Retaining ring	3271500	3273100
029	Fan cowl	3292400	3292900
030	Gasket	3300100	3300100
031/032/033/034	Silencer Assembly	3500100	3500100
031	Silencer insert	3310100	3310100
032	Silencer inlet filter	3320100	3320100
033	Silencer housing	3330100	3330100
034	Silencer bolts	3340100	3340100
043	Flange gasket	3430100	3430100
045	Flange	3450100	3450100
049	Shroud	3497200	3497200
051	Seal	3517200	3517200
052	Channel	3527400	3527400
054	Terminal Block	3540106/3540112	3543106/3543112



4RC-620

Position No.	Description	4RC620-H36	4RC620-H57
003	Front Cover	3037600	3037600
007	Front bearing	3072900	3072900
008	Bearing cover	3082900	3082900
009	O-Ring	3092900	3092900
010	Impeller	3107600	3107600
013	Housing	3137800	3137800
015	Shaft lip seal	3157600	3157600
017	Junction box cover	3170100	3174000
018	Junction box gasket	3180100	3184000
019	Key	3192900	3192900
021	Rotor	3217800	3217900
022	Rear bearing	3222100	3224000
024	Motor cover	3242500	3243500
026	External fan	3263100	3264000
027	Retaining ring	3273100	3274000
029	Fan cowl	3292400	3294400
030	Gasket	3300100	3300100
031/032/033/034	Silencer Assembly	3500100	3500100
031	Silencer insert	3310100	3310100
032	Silencer inlet filter	3320100	3320100
033	Silencer housing	3330100	3330100
034	Silencer bolts	3340100	3340100
043	Flange gasket	3430100	3430100
045	Flange	3450100	3450100
049	Shroud	3497600	3497600
051	Seal	3517600	3517600
052	Channel	3527800	3527800
054	Terminal Block	3543106/3543112	3544006/3544012

4RC-430

Position No.	Description	4RC630-H67
003	Front Cover	3037600
007	Front bearing	3072900
008	Bearing cover	3082900
009	O-Ring	3092900
010	Impeller	3108000
013	Housing	3138000
015	Shaft lip seal	3157600
017	Junction box cover	3174000
018	Junction box gasket	3184000
019	Key	3192900
021	Rotor	3218000
022	Rear bearing	3224000
024	Motor cover	3243500
026	External fan	3264000
027	Retaining ring	3274000
029	Fan cowl	3294400
030	Gasket	3300100
031/032/033/034	Silencer Assembly	3500100
031	Silencer insert	3310100
032	Silencer inlet filter	3320100
033	Silencer housing	3330100
034	Silencer bolts	3340100
043	Flange gasket	3430100
045	Flange	3450100
049	Shroud	3497600
051	Seal	3518000
052	Channel	3528000
054	Terminal Block	3544006/3544012



HRC-202/202-1

Position No.	Description	HRC202	HRC202/1
003	Front Cover	3030500	3030500
007	Front bearing	3070100	3070100
008	Bearing cover	3080100	3080100
009	O-Ring	N/A	N/A
010	Impeller	3100100	3100100
013	Housing	3130500	3130500
015	Shaft lip seal	3150100	3150100
017	Junction box cover	3170100	3170100
018	Junction box gasket	3180100	3180100
019	Key	3190100	3190100
021	Rotor	3210500	3210600
022	Rear bearing	3220100	3220100
024	Motor cover	3240100	3240600
026	External fan	3260100	3260100
027	Retaining ring	3270100	3270600
029	Fan cowl	3290100	3290100
030	Gasket	3300100	3300100
031/032/033/034	Silencer Assembly	3500100	3500100
031	Silencer insert	3310100	3310100
032	Silencer inlet filter	3320100	3320100
033	Silencer housing	3330100	3330100
034	Silencer bolts	3340100	3340100
043	Flange gasket	3430100	3430100
045	Flange	3450100	3450100
049	Shroud	3490500	3490500
051	Seal	3510100	3510100
052	Channel	3520500	3520500
053	Capacitor	N/A	3531200
054	Terminal Block	3540106/3540112	3540106/3540112

HRC-302/302-1

Position No.	Description	HRC302	HRC302/1
003	Front Cover	3030900	3030900
007	Front bearing	3070100	3070100
008	Bearing cover	3080100	3080100
009	O-Ring	N/A	N/A
010	Impeller	3100100	3100100
013	Housing	3130900	3130900
015	Shaft lip seal	3150100	3150100
017	Junction box cover	3170100	3170100
018	Junction box gasket	3180100	3180100
019	Key	3190100	3190100
021	Rotor	3210900	3211000
022	Rear bearing	3221800	3221800
024	Motor cover	3240900	3240900
026	External fan	3260900	3260900
027	Retaining ring	3270900	3270900
029	Fan cowl	3290900	3290900
030	Gasket	3300100	3300100
031/032/033/034	Silencer Assembly	3500100	3500100
031	Silencer insert	3310100	3310100
032	Silencer inlet filter	3320100	3320100
033	Silencer housing	3330100	3330100
034	Silencer bolts	3340100	3340100
043	Flange gasket	3430100	3430100
045	Flange	3450100	3450100
049	Shroud	3490900	3490900
051	Seal	3510100	3510100
052	Channel	3520900	3520900
053	Capacitor	N/A	Contact Republic
054	Terminal Block	3540106/3540112	3540106/3540112



HRC-402S/402/402-1

Position No.	Description	HRC402S	HRC402	HRC402/1
003	Front Cover	3031600	3031600	3031600
007	Front bearing	3071100	3071100	3071100
008	Bearing cover	3081100	3081100	3081100
009	O-Ring	N/A	N/A	N/A
010	Impeller	3101500	3101100	3101100
013	Housing	3131600	3131600	3131600
015	Shaft lip seal	3151100	3151100	3151100
017	Junction box cover	3170100	3170100	3170100
018	Junction box gasket	3180100	3180100	3180100
019	Key	3191100	3191100	3191100
021	Rotor	3211500	3211600	3211700
022	Rear bearing	3221800	3221800	3222100
024	Motor cover	3241800	3241800	3241800
026	External fan	3261800	3261800	3261800
027	Retaining ring	3271500	3271500	3271500
029	Fan cowl	3291800	3292400	3292400
030	Gasket	3301100	3301100	3301100
031/032/033/034	Silencer Assembly	3501100	3501100	3501100
031	Silencer insert	3311100	3311100	3311100
032	Silencer inlet filter	3321100	3321100	3321100
033	Silencer housing	3331100	3331100	3331100
034	Silencer bolts	3341100	3341100	3341100
043	Flange gasket	3431100	3431100	3431100
045	Flange	3451100	3451100	3451100
049	Shroud	3491600	3491600	3491600
051	Seal	3511500	3511100	3511100
052	Channel	3521600	3521600	3521600
053	Capacitor	N/A	N/A	Contact Republic
054	Terminal Block	3540106/3540112	3540106/3540112	3540106/3540112

HRC-502/602/702

Position No.	Description	HRC502	HRC602	HRC702
003	Front Cover	3032400	3032400	3032400
007	Front bearing	3071800	3071800	3071800
008	Bearing cover	3081800	3081800	3081800
009	O-Ring	N/A	N/A	N/A
010	Impeller	3101800	3101800	3101800
013	Housing	3132400	3132400	3132400
015	Shaft lip seal	3151800	3152000	3152000
017	Junction box cover	3170100	3173100	3173100
018	Junction box gasket	3183100	3183100	3183100
019	Key	3191800	3191800	3191800
021	Rotor	3212400	3212500	3212600
022	Rear bearing	3221800	3223100	3223100
024	Motor cover	3241800	3242500	3242500
026	External fan	3261800	3263100	3263100
027	Retaining ring	3271500	3273100	3273100
029	Fan cowl	3292400	3292900	3292900
030	Gasket	3301800	3301800	3301800
031/032/033/034	Silencer Assembly	3501800	3501800	3501800
031	Silencer insert	3311800	3311800	3311800
032	Silencer inlet filter	3321800	3321800	3321800
033	Silencer housing	3331800	3331800	3331800
034	Silencer bolts	3341800	3341800	3341800
043	Flange gasket	3431800	3431800	3431800
045	Flange	3451800	3451800	3451800
049	Shroud	3492400	3492400	3492400
051	Seal	3512000	3512000	3512000
052	Channel	3522400	3522400	3522400
054	Terminal Block	3540106/3540112	3543106/3543112	3543106/3543112



HRC-802/902/1002

Position No.	Description	HRC802	HRC902	HRC1002
003	Front Cover	3033400	3033400	3033400
007	Front bearing	3072900	3072900	3072900
008	Bearing cover	3082900	3082900	3082900
009	O-Ring	3092900	3092900	3092900
010	Impeller	3102900	3102900	3102900
013	Housing	3133400	3133400	3133400
015	Shaft lip seal	3152000	3153400	3153400
017	Junction box cover	3173100	3174000	3174000
018	Junction box gasket	3183100	3184000	3184000
019	Key	3192900	3192900	3192900
021	Rotor	3213400	3213500	3213600
022	Rear bearing	3223100	3224000	3224000
024	Motor cover	3242500	3243500	3243500
026	External fan	3263100	3264000	3264000
027	Retaining ring	3273100	3274000	3274000
029	Fan cowl	3293900	3294400	3294400
030	Gasket	3301800	3301800	3301800
031/032/033/034	Silencer Assembly	3501800	3501800	3501800
031	Silencer insert	3311800	3311800	3311800
032	Silencer inlet filter	3321800	3321800	3321800
033	Silencer housing	3331800	3331800	3331800
034	Silencer bolts	3341800	3341800	3341800
043	Flange gasket	3431800	3431800	3431800
045	Flange	3451800	3451800	3451800
049	Shroud	3493400	3493400	3493400
051	Seal	3513400	3513400	3513400
052	Channel	3523400	3523400	3523400
054	Terminal Block	3543106/3543112	3544006/3544012	3544006/3544012

HRC-1102/1202

Position No.	Description	HRC1102	HRC1202
003	Front Cover	3034200	3034200
007	Front bearing	3073900	3073900
008	Bearing cover	3083900	3083900
009	O-Ring	3093900	3093900
010	Impeller	3103900	3103900
013	Housing	3134200	3134200
015	Shaft lip seal	3154200	3154200
017	Junction box cover	3174900	3174900
018	Junction box gasket	3184900	3184900
019	Key	3193900	3193900
021	Rotor	3214200	3214300
022	Rear bearing	3224900	3224900
024	Motor cover	3244200	3244200
026	External fan	3264900	3264900
027	Retaining ring	3274900	3274900
029	Fan cowl	3294800	3294800
030	Gasket	3303900	3303900
031/032/033/034	Silencer Assembly	3503900	3503900
031	Silencer insert	3313900	3313900
032	Silencer inlet filter	3323900	3323900
033	Silencer housing	3334400	3334400
034	Silencer bolts	3344400	3344400
043	Flange gasket	3434400	3434400
045	Flange	3454400	3454400
049	Shroud	3494200	3494200
051	Seal	3514200	3514200
052	Channel	3524200	3524200
054	Terminal Block	3544006/3544012	3544006/3544012



HRC-1203/1402/1452/1502

Position No.	Description	HRC1302	HRC1402	HRC1452	HRC1502
003	Front Cover	3035100	3035100	3035100	3035100
007	Front bearing	3074800	3074800	3074800	3074800
008	Bearing cover	3084800	3084800	3084800	3084800
009	O-Ring	3093900	3093900	3093900	3093900
010	Impeller	3104800	3104800	3104800	3104800
013	Housing	3135100	3135100	3135100	3135100
015	Shaft lip seal	3154800	3154800	3154800	3154800
017	Junction box cover	3174900	3174900	3174900	3174900
018	Junction box gasket	3184900	3184900	3184900	3184900
019	Key	3194800	3194800	3194800	3194800
021	Rotor	3215100	3215200	3215300	3215400
022	Rear bearing	3224900	3224900	3224900	3224900
024	Motor cover	3244200	3244200	3244200	3244200
026	External fan	3264900	3264900	3264900	3264900
027	Retaining ring	3274900	3274900	3274900	3274900
029	Fan cowl	3294800	3294800	3294800	3295100
030	Gasket	3304900	3304900	3304900	3304900
031/032/033/034	Silencer Assembly	3504800	3504800	3504800	3504800
031	Silencer insert	3314800	3314800	3314800	3314800
032	Silencer inlet filter	3324800	3324800	3324800	3324800
033	Silencer housing	3334800	3334800	3334800	3334800
034	Silencer bolts	3344800	3344800	3344800	3344800
043	Flange gasket	3434800	3434800	3434800	3434800
045	Flange	3454800	3454800	3454800	3454800
049	Shroud	3495100	3495100	3495100	3495100
051	Seal	3514800	3514800	3514800	3514800
052	Channel	3525100	3525100	3525100	3525100
054	Terminal Block	3544006/3544012	3544006/3544012	3544006/3544012	3544006/3544012





Air Knife Systems

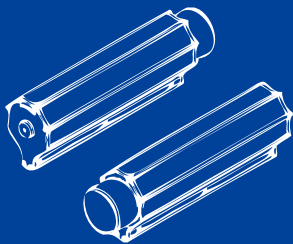

Centrifugal Blowers



Regenerative Blowers



Vacuum Pumps



5131 Cash Road, Dallas, TX 75247 | 800.847.0380 | republic-mfg.com

