



Submersible pump Grundfos MP 1 / Redi-Flo2

User manual



Meet the difference

Contents

1. Information on this manual.....	3
2. General description.....	3
2.1 Applications.....	3
2.2 Technical specifications	4
3. Safety	5
3.1 Safety precautions.....	5
3.1.1 Explosion hazard	5
3.1.2 Personal safety equipment.....	5
3.1.3 Warranty	5
3.1.4 Electrical connection.....	5
3.1.5 Service	5
4. Transportation and storage.....	5
4.1 Delivery.....	5
4.1.1 MP 1/Redi-Flo2 pump	5
4.1.2 Converter	5
4.2 Storage.....	6
4.2.1 MP 1/Redi-Flo2 pump	6
4.2.2 Converter	6
5. Installation	6
5.1 Assembly.....	6
5.2 Borehole diameter.....	6
5.3 Water level.....	6
5.4 Checking of liquid in motor	7
5.5 Pipe connection	7
5.6 Lowering the pump.....	7
5.7 Installation depth	7
6. Converter	8
6.1 Position of the converter	8
6.2 Converter keypad.....	8
7. Electrical connection.....	9
7.1 Connection of the MP 1/Redi-Flo2 pump to the converter.....	9
8. Start-up and operation	9
8.1 Start-up.....	9
8.1.1 Speed control.....	9
8.2 Operation.....	10
8.2.1 Setting of pump performance	10
8.2.2 Minimum flow.....	10
8.2.3 After use	10
8.3 Performance curves MP 1 / Redi-Flo2 pump	10
9. Maintenance and service	11
9.1 Maintenance.....	11
9.2 Service.....	11
10. Dismantling and assembly	12
10.1 Description and overview of the MP 1/Redi-Flo2 sampling pump system.....	12
10.2 Dismantling the pump.....	13
10.3 Checking of components	13
10.4 Assembling the pump	14
11. Trouble shooting.....	15
11.1 Fault code messages	15
12. Disposal	16
Supplement to Installation and Operating Instructions	17
1. Replacement/shortening of motor cable	17
2. Replacement of motor cable.....	17
3. Shortening of motor cable.....	19
3.1 Cable end to motor.....	20
3.2 Checking of direction of rotation	20

Warning! This MP 1/Redi-Flo2 pump does not contain motor cooling fluid. Fill the motor as directed in these instructions.

1. Information on this manual



If the text follows a mark (as shown on the left), this means that an important instruction follows.



If the text follows a mark (as shown on the left), this means that an important warning follows relating to danger to the user or damage to the apparatus. The user is always responsible for its own personal protection.

Text

Italic indicated text indicates that the text concerned appears in writing on the display or the apparatus (or must be typed).

2. General description



Prior to installation, read these installation and operating instructions (also read the separate manual on the frequency converter). Installation and operation must comply with local regulations and accepted codes of good practice.

The Grundfos MP 1/Redi-Flo2 submersible pump is specially designed for the purging and sampling of contaminated groundwater in boreholes with an internal diameter of at least 50 mm. The pump is powered via an adjustable converter in the 25 to 400 Hz frequency range. At 400 Hz, the pump provides a flow rate of 1 m³/h at 74 metres head.



The pump must always be powered via the converter. See fig. 1.

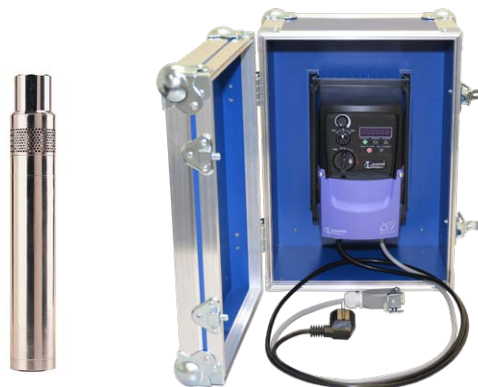

Fig. 1 Submersible pump Grundfos MP 1/Redi-Flo2 and frequency converter

Pump and converter (motor) form a complete unit that can easily be dismantled for cleaning and servicing. The Teflon power cable is available in different lengths.

2.1 Applications

The Grundfos MP 1/Redi-Flo2 pump is designed for the purging and sampling of contaminated water. The maximum sand content of the water must not exceed 50 g/m³. A larger sand content will reduce the life of the service parts and increase the risk of blocking of the pump. Water temperature: +1 °C to +30 °C.

All pump components are made from materials not giving off foreign matter to the pumped liquid except PFOS/PFOA. If you are going to sample for these parameters, please ask your distributor how to act. For other contaminants the sample taken is not influenced nor altered by the pump.

To avoid cleaning the pump and to eliminate the risk of cross-contamination, permanent installation of the pump is recommended.

It is possible to use the same pump for sampling in several boreholes if the risk of cross-contamination can be eliminated.



The MP 1/Redi-Flo2 pump is not designed for the pumping of concentrated oils, chemicals or explosive liquids.

When pumping liquids with a density or kinematic viscosity higher than that of water, a motor input power higher than the rated power is required. The maximum performance must therefore be reduced by changing the frequency.



When the MP 1/Redi-Flo2 pump is used, the regulations covering the handling of hazardous material and possible local regulations must be observed.



The MP 1/Redi-Flo2 pump is not designed for continuous operation like for instance remedial pumping. Continuous operation may reduce the life of the pump.

2.2 Technical specifications

Marking: The MP 1/Redi-Flo2 sampling pump system is CE-marked.

Submersible pump Grundfos MP 1/Redi-Flo2:

Power input: 1.3 kW
Voltage: 3 x 220 V, 400 Hz
Maximum current: 5.5 A
Motor protection: Built-in thermal switch
Water temperature: 0 °C to +35 °C
Discharge port: Rp 3/4
Continuous operation: Maximum 500 hours
Net weight: 2.5 kg

Frequency converters:

Supply voltage: 1 x 200-240 V (+/- 10%), 50/60 Hz
Minimum generator size: With voltage control:
• 3.0 kVA (suitable for non-linear loads, minimal value)
• 4.5 kVA (suitable for non-linear loads, recommended value)
• 7.5 kVA (not suitable for non-linear loads)
Nominal input current: 12.9 A
Nominal output current: 7.0 A

Supply voltage: 1 x 110-115 V (+/- 10%), 50/60 Hz
Minimum generator size: With voltage control:
• 2.2 kVA (suitable for non-linear loads, minimal value)
• 3.3 kVA (suitable for non-linear loads, recommended value)
• 5.5 kVA (not suitable for non-linear loads)
Nominal input current: 21.9 A
Nominal output current: 5.8 A

Fuse: 10 A
Power factor: 0.65
Connecting cable: 3 x 1.5 mm², 3 m with plug.
Output voltage: 3 x 15.4 V, 25 Hz, to 3 x 235 V, 400 Hz
Motor protection: Built-in overcurrent protection, set to 6.1 A
Acceleration time: 0 to 400 Hz: Maximum 6 sec
Deceleration time: 400 to 0 Hz: Maximum 6 sec
Enclosure class: IP66
Ambient temperature: -10 °C to +40 °C
Relative air humidity: Maximum 95 %
Weight: 8.0 kg (incl. case).

3. Safety

3.1 Safety precautions



During handling, operation, storage and transportation, the environmental regulations covering the handling of hazardous material must be observed.

When the pump is taken out of operation, care must be taken to ensure that the pump contains no hazardous material that might be injurious to human health or to the environment.

The motor is not factory-filled with liquid (the user has to fill approx. 25 ml demineralised water). During operation, this liquid is wholly or partly replaced by the contaminated water. Therefore, there is a potential risk of contamination and poisoning.

The water delivered by the pump may be contaminated and/or toxic. The regulations covering the handling of hazardous material must therefore be observed.

3.1.1 Explosion hazard

The pumping system is not approved as explosion-proof. Local authorities and regulations should be consulted if there is any doubt about its suitability for a certain application.

3.1.2 Personal safety equipment

When pumping water containing hazardous material, personal safety equipment must be used.

3.1.3 Warranty

Pumps installed in accordance with these instructions and accepted codes of good practice are covered by the warranty.

Any constructional change of the pumping system will invalidate the warranty. Eijkelkamp Soil & Water cannot be held responsible for possible consequential damage.

3.1.4 Electrical connection

When lowering/pulling out the pump, take care not to damage the motor (power) cable. The electrical connections should be carried out in accordance with local regulations.



Never fit or remove the motor cable plug from the converter unless the electricity supply to the converter has been switched off.

3.1.5 Service



Only pumps that can be certified as uncontaminated, i.e. pumps containing no hazardous and/or toxic material, may be returned to Eijkelkamp Soil & Water for servicing.

See section 9.2 Service.

4. Transportation and storage

4.1 Delivery

4.1.1 MP 1/Redi-Flo2 pump

After production, the pump has been ultrasonically cleaned and packed into a polyethylene bag. This means that the pump has not been in contact with dirt or detergents after cleaning and it is untouched by persons.

4.1.2 Converter



The converter should not be exposed to unnecessary shocks and should be handled like sensitive electronic equipment.

4.2 Storage

The pumping system should be stored in a clean and dry area.

4.2.1 MP 1/Redi-Flo2 pump

Storage temperature: $-20\text{ }^{\circ}\text{C}$ to $+50\text{ }^{\circ}\text{C}$.

If the pump has to be stored after use, it must be cleaned thoroughly before storing. See section 9. Maintenance and service.

4.2.2 Converter

The converter should be stored in a clean and dry area. Storage temperature: $-10\text{ }^{\circ}\text{C}$ to $45\text{ }^{\circ}\text{C}$.

5. Installation

5.1 Assembly

The pump can be installed either horizontally or vertically. The pump discharge port should never fall below the horizontal plane. See fig. 2.

During operation, the pump must always be completely submerged in the liquid.

The pump performance is controlled by changing the frequency. The installation of a valve in the discharge pipe is unnecessary and with regard to the water sample directly inappropriate.

If a valve has been installed anyway, make sure that the pump is only operated against a closed valve for a very short period.

Otherwise the heat generated will cause the pump to stop.

If a non-return valve is installed in the discharge pipe, it must be installed at least 0.5 metres above the pump. This is necessary to ensure that the air in the pump is compressed so much that the pump contains water when it is being submerged.

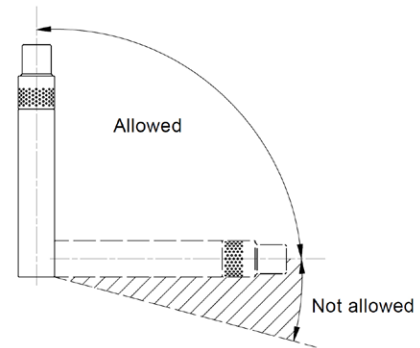

Fig. 2 Positional requirements

5.2 Borehole diameter

The inside diameter of the sampling borehole must be at least 50 mm. At the first sampling, it is recommended to check the borehole for clearance by means of a calibration punch. If the borehole diameter is larger than 80 mm, the pump can be fitted in a cooling jacket/flow sleeve to prevent unintended pump cut-outs. See fig. 3.

5.3 Water level

The dynamic water level (depth to the water level in the borehole during operation) must not exceed 80 metres.

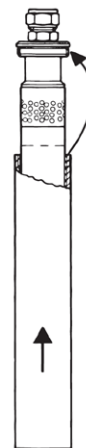

Fig. 3 MP 1/Redi-Flo2 in cooling jacket (flow sleeve)

5.4 Checking of liquid in motor

The level of the liquid in the motor should be checked before the pump is installed.

1. Place the pump and motor in a vertical position with the discharge port pointing downwards (i.e. the bottom of the motor is uppermost), and remove the filling screw. See fig. 4.
2. If the water stands up to the edge of the threaded hole, no filling is required. If not, fill demineralised water into the motor. To enable all air to escape, insert your finger in the pump discharge port and lift the shaft a few times. Recheck the liquid level.
3. Replace and tighten the filling screw.

The pump is now ready for installation.

5.5 Pipe connection

Pump discharge port: Rp 3/4.

A pipe or a hose can be connected to the pump.

Whenever a hose is fitted, a compression coupling must be used.

See fig. 5.

Tighten the union nut using fingers only and then give it 1 1/4 turns with a tool.

If PTFE pipes or hoses or unarmoured hoses are used, a stainless-steel straining wire is required for lowering and lifting the pump.

Secure the straining wire to the pump with a wire holder. See fig. 6.

5.6 Lowering the pump

Lower the pump into the borehole, taking care not to damage the motor cable.



Do not lower or lift the pump by the motor cable.

5.7 Installation depth

During operation, the pump and motor must be completely submerged to ensure the necessary lubrication of the shaft seal and cooling of the motor.

If the pump pumps more water than the borehole can yield, there is a risk that the water level falls below the level of the pump inlet and that air is therefore sucked into the pump.



Long time of operation with water containing air may damage the pump and cause insufficient cooling of the motor.

If a non-return valve is installed in the discharge pipe, it must be installed **at least 0.5 metres** above the pump. This is necessary to ensure that the air in the pump is compressed so much that the pump contains water when it is being submerged.



Fig. 4 Removal of filling screw

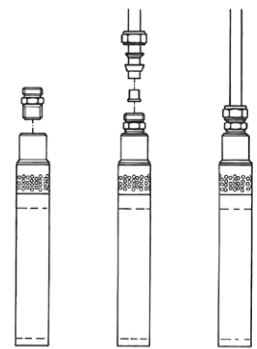

Fig. 5 Use of compression coupling

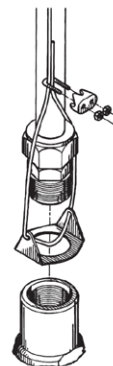

Fig. 6 Fitting the straining wire

6. Converter

6.1 Position of the converter



Place the converter with cabinet (case) in such a way that water cannot enter into the cabinet.
Do not close the cabinet during operation.

The converter must be installed vertically to ensure free air circulation around the unit. See fig. 7.

Make sure that the cabinet/converter cannot tip during operation.



Fig. 7 Vertical installation of the converter

6.2 Converter keypad

Before they leave the factory, Eijkelkamp Soil & Water has programmed the converters for use with the MP 1 (converter art. no. 122746) and for use with the Redi-Flo2 (converter art. no. 122747) pump. The rest of the functions are blocked by a password and can only be changed by Eijkelkamp. That is why **only 3** buttons are used to operate the MP 1/Redi-Flo2 pump.

Switch 1: to start the convertor, after connecting it to the power supply (switch turns hard).

Switch 2: to set the direction of rotation to Forward (FWD) (Function REW is disabled by Eijkelkamp, because this will damage the pump).

Switch 3: to set the speed from 0 to 400 Hz.



Fig. 8a Pump operation switches



Fig. 8b Switch 1 set to ON



Fig. 8c Switch 2 set to FWD



Fig. 8d Switch 3 set to 200 Hz



Fig. 8e Switch 3 set to the max 400 Hz

7. Electrical connection



Before starting work on the pump, make sure that the electricity supply has been switched off and that it cannot be accidentally switched on.



Use the separate manual (M122746) on both converters for instructions on connecting the converter.

7.1 Connection of the MP 1/Redi-Flo2 pump to the converter

Connect the power (motor) cable from the pump with the power/motor cable of the converter.



Never fit or remove the motor cable plug from the converter unless the electricity supply to the converter has been switched off.

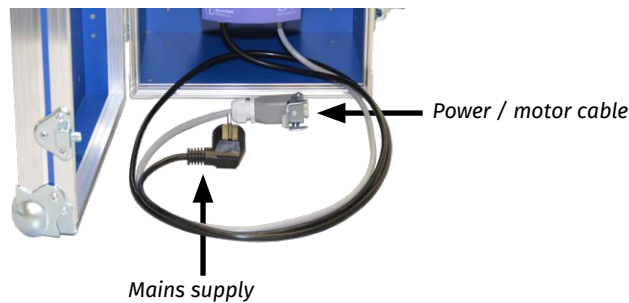

Fig. 9 Converter connections

8. Start-up and operation

8.1 Start-up

Switch on the electricity supply when the pump has been installed and connected to the converter.

- Turn switch 1 to ON to start the converter
The display shows: StoP (see fig. 8b)
- Turn switch 2 to FWD
The display shows: H 00 (see fig 8c)

8.1.1 Speed control

- Turn switch 3 to in- or decrease the speed.
The display shows the actual speed (see fig. 8d and 8e)



The MP 1/Redi-Flo2 pump is not designed for continuous operation like for instance remedial pumping. Continuous operation may reduce the life of the pump.

8.2 Operation



The MP 1/Redi-Flo2 pump is not designed for continuous operation like for instance remedial pumping. Continuous operation may reduce the life of the pump.

8.2.1 Setting of pump performance

When the pump speed has been changed, wait a while to let the speed settle at the set level. Then new adjustments can be made.

8.2.2 Minimum flow

To ensure the necessary cooling of the motor, the pump should never be set so low that it gives no water. If the flow rate suddenly falls, the reason might be that the pump is pumping more water than the borehole can yield. The pump performance must immediately be reduced or the pump must be stopped to avoid damage to the pump.

8.2.3 After use

After use, switch off the electricity supply to the converter **before** the motor cable is disconnected from the converter.

8.3 Performance curves MP 1 / Redi-Flo2 pump

Example

When the static head is 66 m, discharge of the pump will be 0,34 l/s.
In practice the discharge/pressure will be less because of losses.

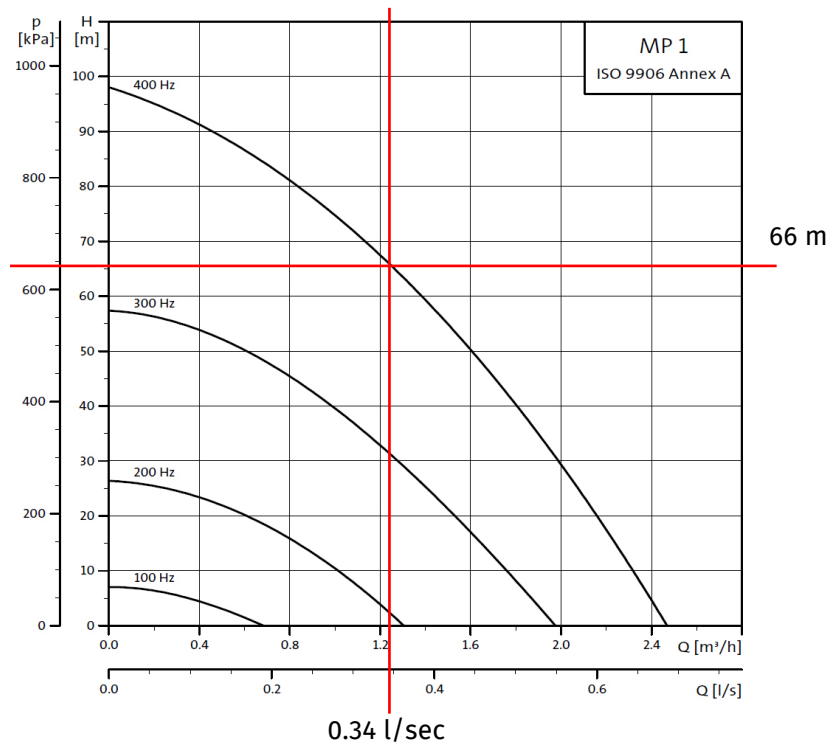

9. Maintenance and service

9.1 Maintenance

If the pump is used alternately in several boreholes, it must be decontaminated before every sampling event or before possible storing. Clean the pump, cable, straining wire, etc. on the outside. Then dismantle the pump. Thoroughly clean the pump components before reassembling the pump. See section 10. Dismantling and assembly.

As the demineralised water (approx. 25 ml) in the motor may have been wholly or partly replaced by the contaminated water, it is necessary to refill the motor with demineralised water. See section 5.4 Checking of liquid in motor.

For the replacement of wear parts including impellers, see fig. 10, a service kit (art. no.: 12274301) is available. The kit includes two complete pump stages. Replace the wear parts including impellers as shown in section 10. Dismantling and assembly.

In addition, a service kit (product number 12274311) is available. This kit includes wear parts for two pumps, i.e. 4 washers, pos. 285, and 4 seals, pos. 207. See fig. 10.

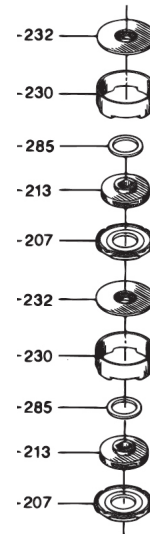

Fig. 10 Wear parts MP 1 pump



The rinsing water from the decontamination and the motor liquid must be collected and disposed of in accordance with local regulations

9.2 Service

The MP 1/Redi-Flo2 pump is specially designed for the purging and sampling of contaminated and/or toxic groundwater. As a precaution, Eijkelkamp Soil & Water cannot undertake to service the pump.

Only pumps that can be certified as uncontaminated, i.e. pumps containing no hazardous and/or toxic material, may be returned to Eijkelkamp Soil & Water for servicing.

To prevent injury to the health of persons involved and to the environment, a document certifying that the pump is clean is required.

Eijkelkamp Soil & Water must receive this certificate before the product. Otherwise Eijkelkamp Soil & Water will refuse to accept the product for servicing. Possible costs of returning the product are paid by the customer.

If the converter is defective, please contact your nearest Eijkelkamp Soil & Water distributor.

10. Dismantling and assembly

10.1 Description and overview of the MP 1/ Redi-Flo2 sampling pump system

Components

Pos.	Designation
1	Motor with suction interconnector
74	Filling screw
74a	O-ring for filling screw
200	Service kit: wear parts including impellers
201a	Chamber/pump housing
207	Seal
213	Impeller
215	Strainer
215a	Screw
230	Intermediate ring
232	Guide vanes
285	Washer
A	Pump with motor
B	Converter

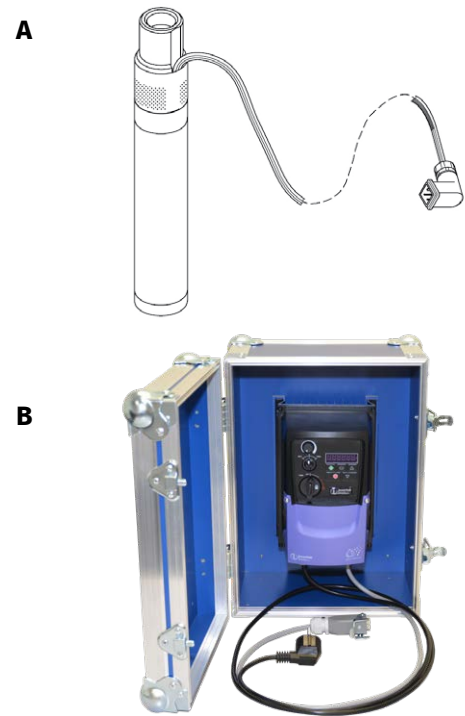

Fig. 11 Pump with converter

When servicing the MP 1/Redi-Flo2 sampling pump, note that the pumped liquid is often unknown. Therefore, the necessary precautionary measures must be taken in accordance with local regulations.



All work on the electric parts of the MP 1/Redi-Flo2 sampling pump system must be carried out by a qualified service engineer.

If the motor, motor cable, converter or converter cable is defective, please contact your nearest Eijkelkamp Soil & Water distributor.

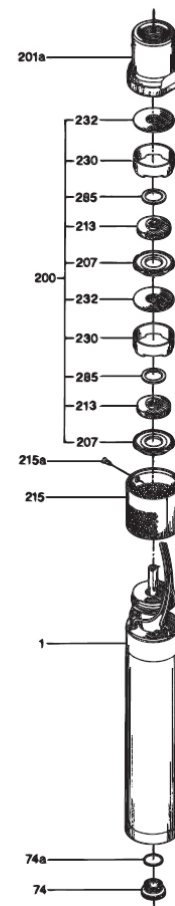

Fig. 12 Pump components

10.2 Dismantling the pump

Procedure (see fig. 12):

1. Place the pump in upright position with the discharge port uppermost.
 2. If the pump is fitted with hose and fittings, remove these.
 3. Slacken and remove the screw (pos. 215a).
 4. Remove the strainer (pos. 215).
 5. Screw (right-hand thread) the pump housing (pos. 201a) off the suction interconnector on the motor (pos. 1).
 6. Pull the pump housing and the wear parts including impellers (pos. 200) off the motor shaft. Push the wear parts including impellers out of the pump housing from the discharge side.
 7. Dismantle the wear parts including impellers (pos. 200).
 8. Clean the holes in the suction interconnector.
 9. Clean and check all parts. See section 10.3 Checking of components.
- For assembly of the pump, see section 10.4 Assembling the pump.

10.3 Checking of components

When the pump has been dismantled, all parts must be cleaned and checked for fractures, corrosion and wear. Apart from the visual inspection, it is necessary to measure the following parts:

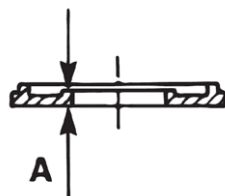

Fig. 13 Seal (pos. 207) - A = minimal 1.5 mm

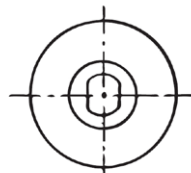
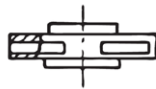

Fig. 14 Impeller (pos. 213) - no measurable wear

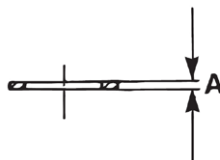

Fig. 15 Washer (pos. 285) - A = minimal 1.0 mm

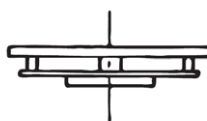

Fig. 16 Guide vanes (pos. 232) - no measurable wear

10.4 Assembling the pump

Procedure (see fig. 17):

1. Fit the seal (pos. 207) to the intermediate ring (pos. 230). The dogs of the intermediate ring must engage with the seal.
 2. Position the intermediate ring and the seal on the motor with suction interconnector (pos. 1).
 3. Fit the impeller (pos. 213) to the shaft and push it against the seal (pos. 207). The skirt of the impeller must fit into the hole of the seal.
 4. Fit the washer (pos. 285) to the impeller.
 5. Fit the guide vanes (pos. 232) to the intermediate ring.
 6. Repeat the procedure with seal, intermediate ring, impeller, washer and guide vanes.
 7. Push the pump housing (pos. 201a) over the wear parts including impellers (pos. 200) and screw it on the suction interconnector on the motor (pos. 1). See fig. 12.
 8. Position the cable along the pump housing (in the recess).
 9. Push the strainer (pos. 215) over the pump housing, and press it against the motor. Turn the strainer to the right so that the hole of the strainer and that of the pump housing are in the same position.
 10. Fit and tighten the screw (pos. 215a).
- The pump is now assembled and it can be tested.

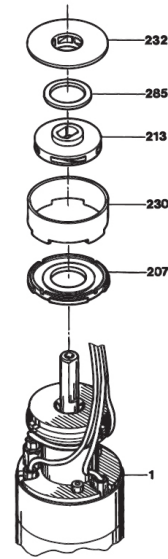

Fig. 17 Assembling the pump

11. Trouble shooting

11.1 Fault code messages

Fault Code	No.	Description	Suggested remedy
no-FLt	00	No fault	Not required
0 i-b	01	Brake channel over current	Check external brake resistor condition and connection wiring
0L-br	02	Brake resistor overload	The drive has tripped to prevent damage to the brake resistor
0- i	03	Output Over Current	Instantaneous Over current on the drive output. Excess load or shock load on the motor.
l_t-terP	04	Motor Thermal Overload (I2t)	The drive has tripped after delivering >100% of value in P-08* for a period of time to prevent damage to the motor.
PS-terP	05	Power stage trip	Check for short circuits on the motor and connection cable
0-UoLt	06	Over voltage on DC bus	Check the supply voltage is within the allowed tolerance for the drive. If the fault occurs on deceleration or stopping, increase the deceleration time in P-04* or install a suitable brake resistor and activate the dynamic braking function with P-34*
U-UoLt	07	Under voltage on DC bus	The incoming supply voltage is too low. This trip occurs routinely when power is removed from the drive. If it occurs during running, check the incoming power supply voltage and all components in the power feed line to the drive.
0-t	08	Heatsink over temperature	The drive is too hot. Check the ambient temperature around the drive is within the drive specification. Ensure sufficient cooling air is free to circulate around the drive. Increase the panel ventilation if required. Ensure sufficient cooling air can enter the drive, and that the bottom entry and top exit vents are not blocked or obstructed.
U-t	09	Under temperature	Trip occurs when ambient temperature is less than -10°C. Temperature must be raised over -10°C in order to start the drive.
P-dEF	10	Factory Default parameters loaded	
E-ter iP	11	External trip	E-trip requested on digital input 3. Normally closed contact has opened for some reason. If motor thermistor is connected check if the motor is too hot.
SC-0b5	12	Optibus comms loss	Check communication link between drive and external devices. Make sure each drive in the network has its unique address.
FLt-dc	13	DC bus ripple too high	Check incoming supply phases are all present and balanced
P-L055	14	Input phase loss trip	Check incoming power supply phases are present and balanced
h 0- i	15	Output Over Current	Check for short circuits on the motor and connection cable
th-FLt	16	Faulty thermistor on heatsink	Check the analog input connection(s)
dRtR-F	17	Internal memory fault. (IO)	Press the stop key. If the fault persists, consult you supplier
4-20F	18	4-20mA Signal Lost	Check the analog input connection(s)
dRtR-E	19	Internal memory fault. (DSP)	Press the stop key. If the fault persists, consult you supplier
F-Ptc	21	Motor PTC thermistor trip	Connected motor thermistor over temperature, check wiring connections and motor
FAn-F	22	Cooling Fan Fault (IP66 only)	Check / replace the cooling fan
0-hERt	23	Drive internal temperature too high	Drive ambient temperature too high, check adequate cooling air is provided
RtF-01	40	Autotune Fault	The motor parameters measured through the autotune are not correct Check the motor cable and connections for continuity Check all three phases of the motor are present and balanced
RtF-02	41		
RtF-03	42		
RtF-04	43		
RtF-05	44		

5C-F01	50	Modbus comms loss fault	Check the incoming Modbus RTU connection cable Check that at least one register is being polled cyclically within the timeout limit set in P-36 Index 3*
5C-F02	51	CANopen comms loss trip	Check the incoming CAN connection cable Check that cyclic communications take place within the timeout limit set in P-36 Index 3*

* See separate manual of the converter

12. Disposal

This product or parts of it must be disposed of in an environmentally sound way:

1. Use the public or private waste collection service.
2. If this is not possible, contact the nearest Eijkelkamp Soil & Water company/distributor.

Supplement to Installation and Operating Instructions

1. Replacement/shortening of motor cable



The submersible drop cable must be complete and without cable joint from the motor to the converter.

A previously connected cable must be fitted with a new cable kit before it can be reused. See 3. Shortening of motor cable.

A video instruction can be found at www.eijkelkamp.com and on the YouTube channel of Royal Eijkelkamp.

2. Replacement of motor cable

Slacken and remove the screw, pos. 215a, together with the strainer, pos. 215. See fig. 1.

Screw the pump housing, pos. 201a, (right-hand thread) off the suction interconnector, pos. 214. Pull the pump housing and the impeller assembly, pos. 200, off the motor shaft.

Push the impeller assembly out of the pump housing from the discharge side.

Slacken the screw, pos. 20k, for the earth lead and pull it off the screw, pos. 222a, together with the earth lead and the washers, pos. 20d and 20f.

Slacken and remove the screws, pos. 222 and 222a

Pull the suction interconnector, pos. 214, off the motor.

Slacken and remove the screws, pos. 20b, holding the motor cable.

Pull the motor cable off the motor.

Screw positions 20d and 20e out of the motor using a small screwdriver and precision electronic pliers.

Before fitting the motor cable, clean the holes in the motor.

Pull positions 20b, 20d and 20e on the three leads (phases) of the motor cable. On the earth lead (yellow/green), the order is pos. 20k, 20d and 20f. See fig. 1.

Bend the stripped end of the earth lead. See fig. 1.

When fitting the plugs in the motor, the first plug can be fitted arbitrarily. Then it is very important that the colour sequence is correct. Clockwise the order is black - blue - brown. See fig. 2.

Push the plug of the lead into the plug of the stator. Then press positions 20e and 20d around the lead and tighten by means of the screw, pos 20b.

Fit the suction interconnector, pos. 214, to the shaft and secure it to the motor with the screws, pos. 222 and 222a.

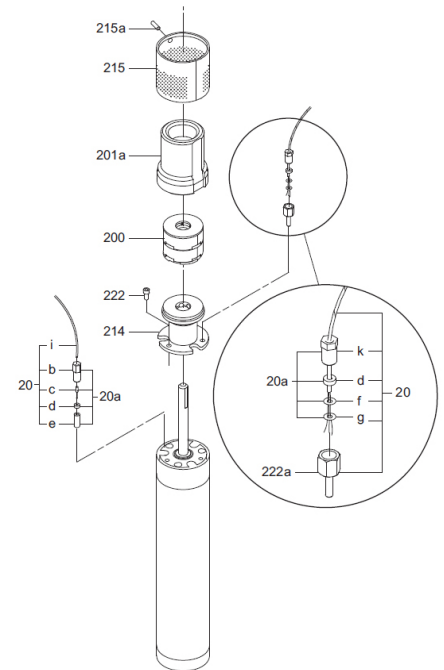

Fig. 1 MP 1/Redi-Flo2 pump components

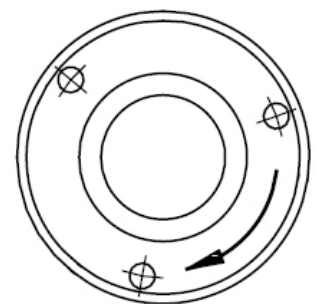
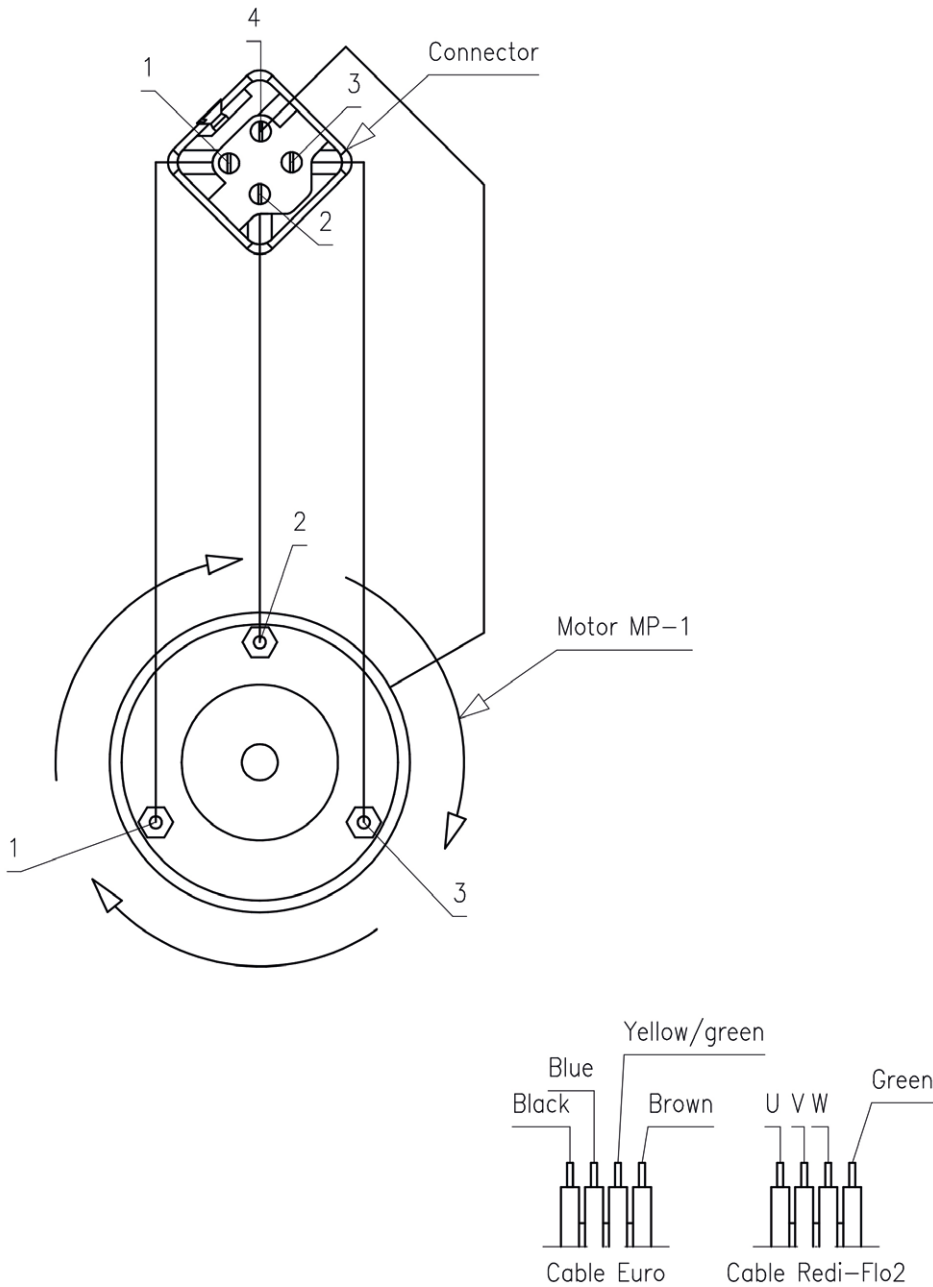

Fig. 2 Colour sequence

Position the washer pos. 20g, on the screw, pos. 222a. Hold the earth lead against the washer while the screw, pos. 20k, is tightened.

Position the cable along the pump housing (in the recess). Push the strainer, pos. 215, over the pump housing and press it against the motor. Turn the strainer to the right so that the hole of the strainer and that of the pump housing are in the same position. Fit and tighten the screw, pos. 215a.

Check the direction of rotation, see 3.2 Checking of direction of rotation



Connector	Motor	Cable Euro	Cable Redi-Flo2
1	1	Blue	Blank – U
2	2	Brown	Blank – V
3	3	Black	Blank – W
4	Housing	Yellow/green	Green

3. Shortening of motor cable



Motor cables with a common plastic sheath cannot be repaired or shortened. See fig. 3.

Motor cables with a plastic sheath for each lead (new type of cable) can be repaired or shortened. See fig. 4.

Cut the cable (new type), separate and strip the leads. See fig. 5.

Cable to motor:

L = 72 mm, L1 = 4 mm.

Cable to frequency converter: L = 45 mm, L1 = 6 mm.

Deburr the individual leads. See fig. 6

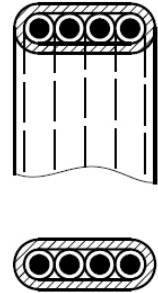

Fig. 3 Cables with common plastic sheath

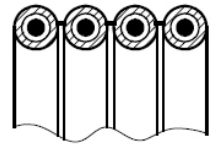

Fig. 4 Cables with plastic sheath for each lead

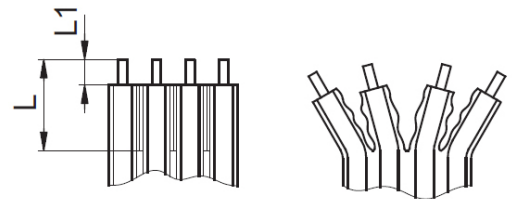

Fig. 5 Cut the cable and separate and strip the leads

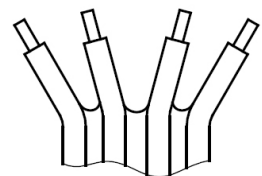

Fig. 6 Deburr the leads

3.1 Cable end to motor

Fit plug pins on the black, blue and brown leads. See fig. 7.

Press home the plug pin and fix it firmly by means of the crimping tool, part no. SV 03 74. See fig. 8.

Fit the cable in the motor. See 2. Replacement of motor cable.

3.2 Checking of direction of rotation

Observe the movement of the pump shaft when the electricity supply is switched on for a short period. The correct direction of rotation is indicated by an arrow on the side of the motor.

Fit the fittings and the hose to the pump. The pump is now reassembled and can be tested.

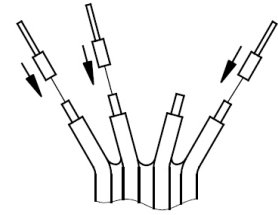

Fig. 7 Fit plug pins

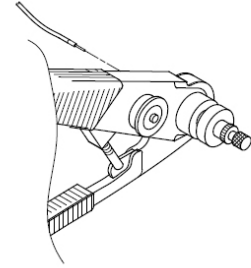

Fig. 8 Fixing the plug pin

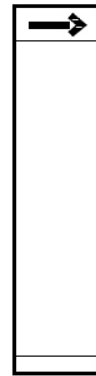

Fig. 9 Checking direction of rotation

Disclaimer

Nothing from this document may be copied and/or made public by means of printing, photocopy, microfilm or in any other way without the prior written approval of the publisher. Technical data can change without prior notification. Eijkelkamp Soil & Water is not responsible and/or liable for any damage and/or personal injury due to (incorrect) use of this product. Eijkelkamp Soil & Water would be pleased to receive your reactions and comments about this product and the user instructions.