



designs

DESIGNS

MS

Single impeller single stage

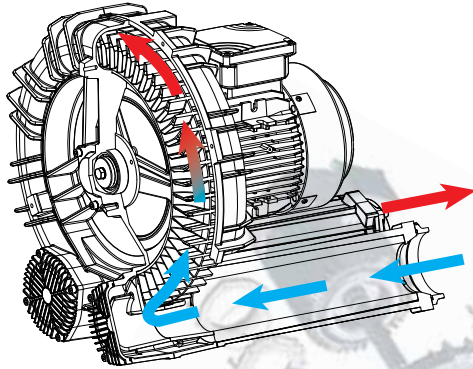

TS

Twin impeller single stage

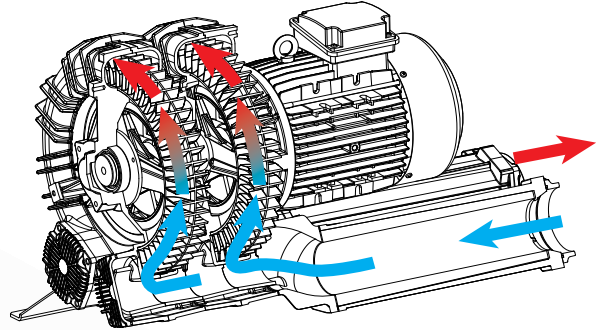

MD

Single impeller double stage

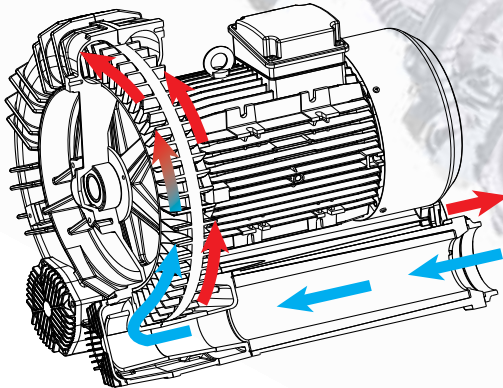

TD

Twin impeller double stage

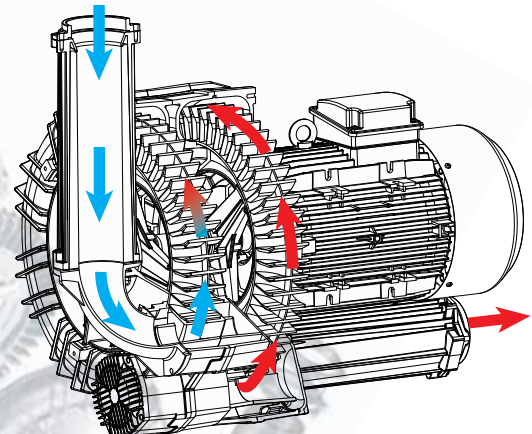

Standard Design

The standard FPZ design is a direct drive configuration, with a dynamically balanced impeller fitted directly on the motor shaft. Fitted motors are 2-pole, 1 or 3 phase, rated for continuous service. Standard motors utilize class F insulation, are suitable for use with a variable speed drive (3 phase only), and are tropicalized for corrosion resistance. Single or two stage options are pictured above.

GOR / GVR Design

"GOR / GVR" designs utilize a standard nema (or metric) electric motor that is directly coupled to the blower shaft. This direct coupled design allows the use of specialty motors that may be required to meet a variety of electrical requirements. For some models the vacuum / pressure capabilities can be increased with this GOR / GVR design (pictured right).

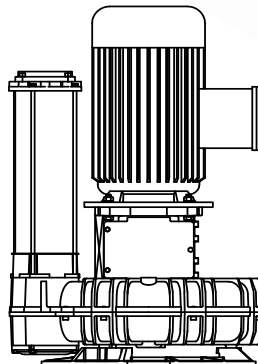

"GVR" Design

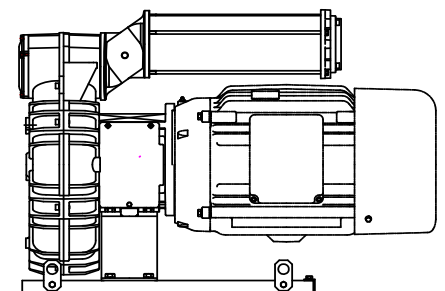

"GOR" Design



applications

APPLICATIONS

Thousands of FPZ blowers are working in a variety of applications: from commercial to industrial installations, in food processing to pharmaceuticals, from textiles to aerospace, in medical applications to environmental. Wherever efficiency and reliability are needed, FPZ responds with the appropriate product "solution"

Advantages of side channel blowers

- Compact execution
- Simple concept
- Reduced maintenance costs
- Modular design
- Pulsation and oil free air

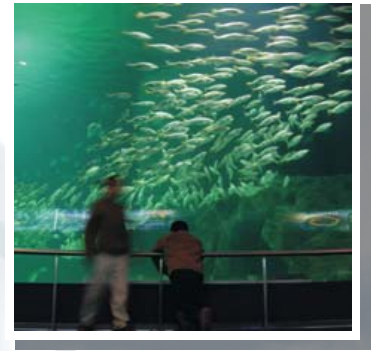
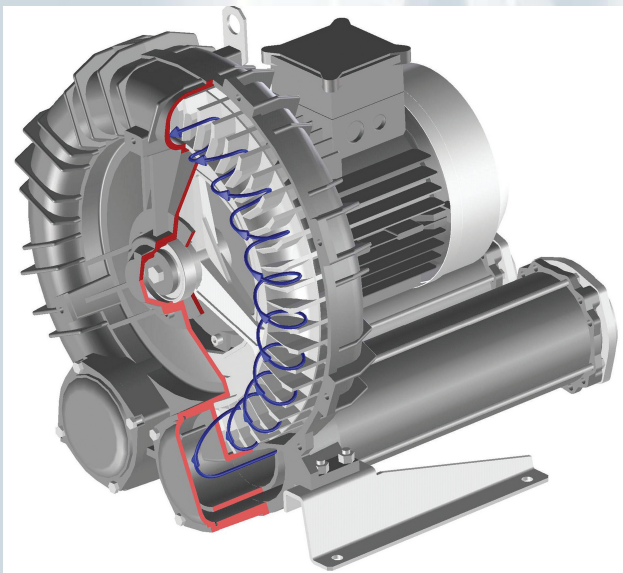

How Blowers Work

Blowers have an impeller blade mounted inside a housing. As air passes the inlet port, impeller blades draw air in and accelerate the air outward and forward. As each impeller blade strikes it, the air moves faster and faster. At the base of the housing an air stripper diverts the air out of the housing reducing the speed and then increasing the pressure.



Table of Contents

SS2109

					Page(s)	
General Pressure and Vacuum Performance Curves					4	5
K Series "MOR" Blowers - Direct Drive		Max CFM	Max Pressure (In H ₂ O)	Max Vacuum (In Hg.)	Pressure	Vacuum
SCL K03-K06 MS	Single Stage Blowers	216	122	8.9	6-7	38-39
SCL K07-K12 MS	Single Stage Blowers	726	201	10.3	8-9	40-41
SCL K05-K06 TS	Single Stage Blowers	400	85	6.3	10-11	42-43
SCL K07-K12 TS	Single Stage Blowers	1410	100	8.1	12-13	44-45
SCL K07R-12 MD	Two Stage Blowers	336	290	14.0	14-15	46-47
SCL K05-K06 TD	Two Stage Blowers	222	180	11.8	16-17	48-49
SCL K07-K12 TD	Two Stage Blowers	716	220	14.0	18-19	50-51

06 / R Series Performance Data

SCL 06	Single Stage Blowers	39	52	3.5	20-21	52-53
SCL 10DL-15DH	Two Stage Blowers	35	120.5	8.1	22-23	54-55
SCL R20-R40 MD	Two Stage Blowers	81	201	11.1	24-25	56-57

K Series Direct Coupled - "GOR/GVR" configuration

SCL K03-K06 MS-GOR/GVR	Single Stage Blowers	216	140	9.6	26-27	58-59
SCL K07-K12 MS-GOR/GVR	Single Stage Blowers	726	200	10.3	28-29	60-61
SCL K05-K06 TS-GOR/GVR	Single Stage Blowers	400	130	7.8	30-31	62-63
SCL K07-K12 TS-GOR/GVR	Single Stage Blowers	1410	150	10.3	32-33	64-45
SCL K07R- K12 MD GOR/GVR	Two Stage Blowers	336	280	14.7	34-35	66-67
SCL K07-K12 TD GOR/GVR	Two Stage Blowers	716	225	13.2	36-37	68-69

Values in above table based on 60 hz performance

Accessories

Installation Guide	General guide on how to install accessories.	70
VG / PG / CV / SS / IH	Gauges, Check Valves, Silencers, and Sound Enclosures	71
VRL6-9	Safety valve selection guide	72
VRL6-9	Safety Valves	73
CSL / CT	Filters for vacuum applications.	74
FS	Filters & dirty filter indicator for pressure applications	75
VK / PK	Flange Connectors for safety valves and flexible hoses	76
VS 6 / VS 8	Flow Converting Devices for diverting air stream	77
CA / CK	Filter Manifolds and 90 Degree Manifold for K series blowers	78
MF / TF / MP	Flexible Sleeves, Flanges, Sleeves	79

Technical

Altitude chart and conversion factors	80
Single Phase Motor information	81
Three Phase Motor Information	82
575 V Premium Efficiency Three Phase Motor Information	83
Airflow Through an Orifice	84
FPZ Pneumatic Range	85

Disclaimer

The information contained in this catalog is based on information that we believe to be correct. It is the users responsibility to determine the suitability of the product for the application they are used in and the user assumes all risk and liability whatsoever in connection therewith.



Pressure Performance Curves

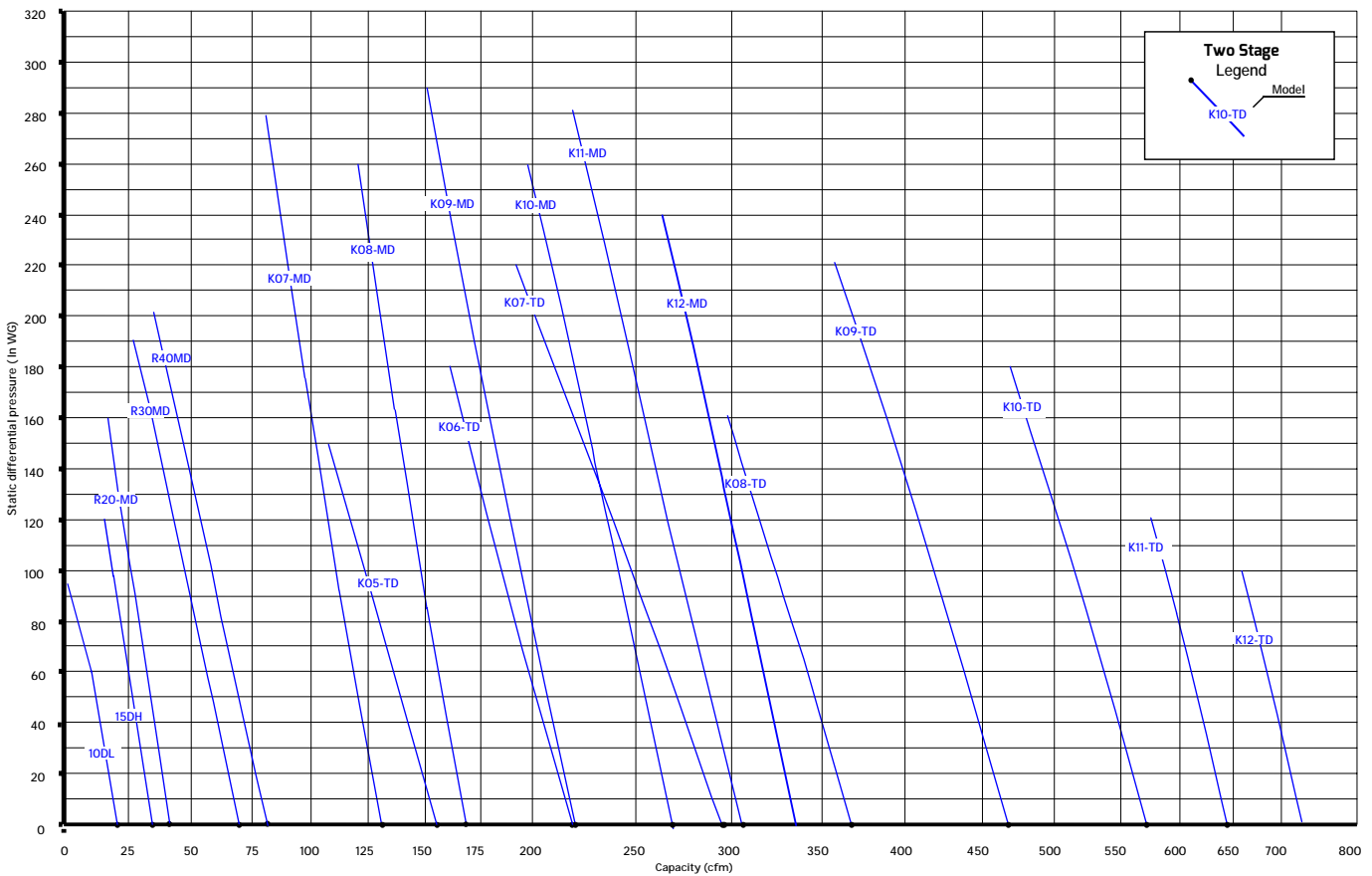
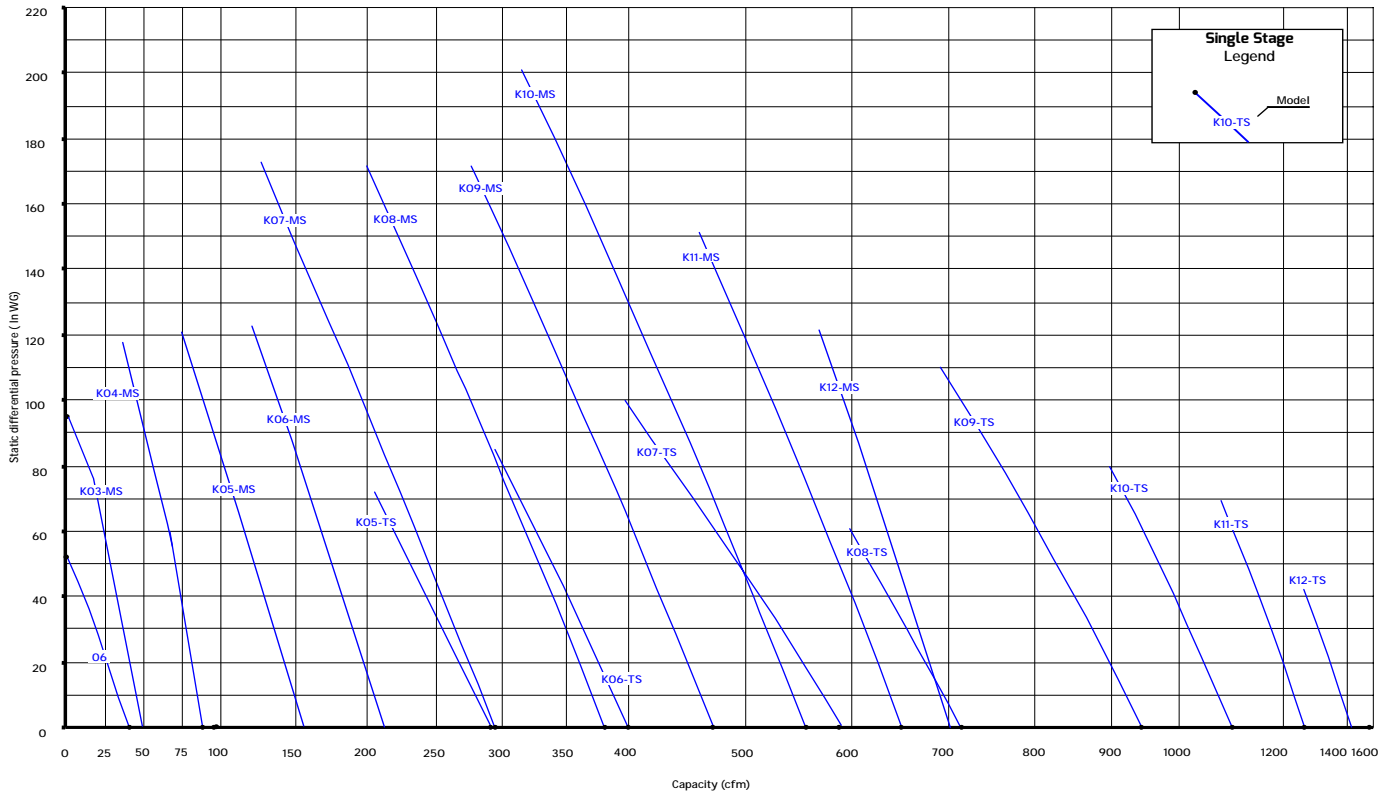

Curves refer to air at 68°F temperature and 29.92 In Hg atmospheric pressure (abs) measured at inlet port.
Tolerance on given values ± 10% - data can change without prior notice.



Vacuum Performance Curves

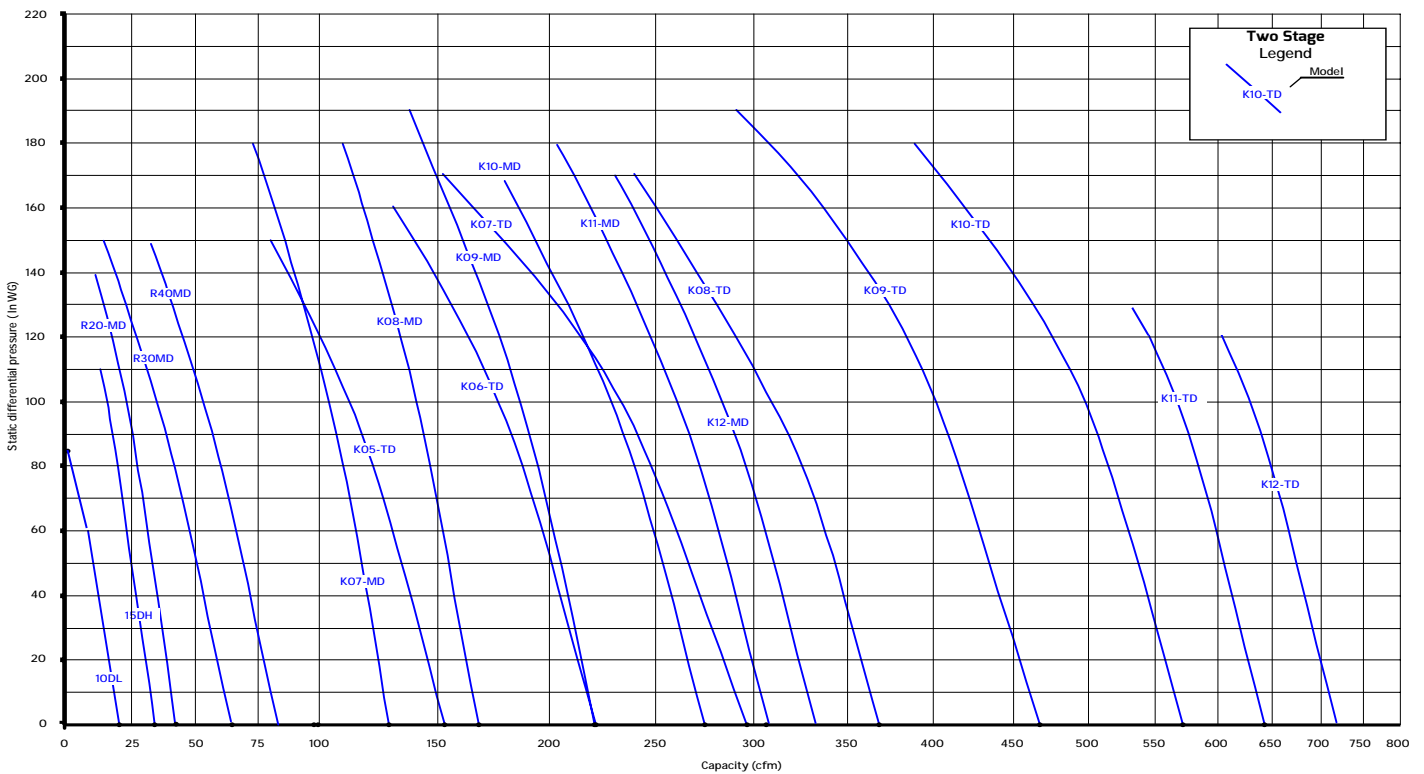
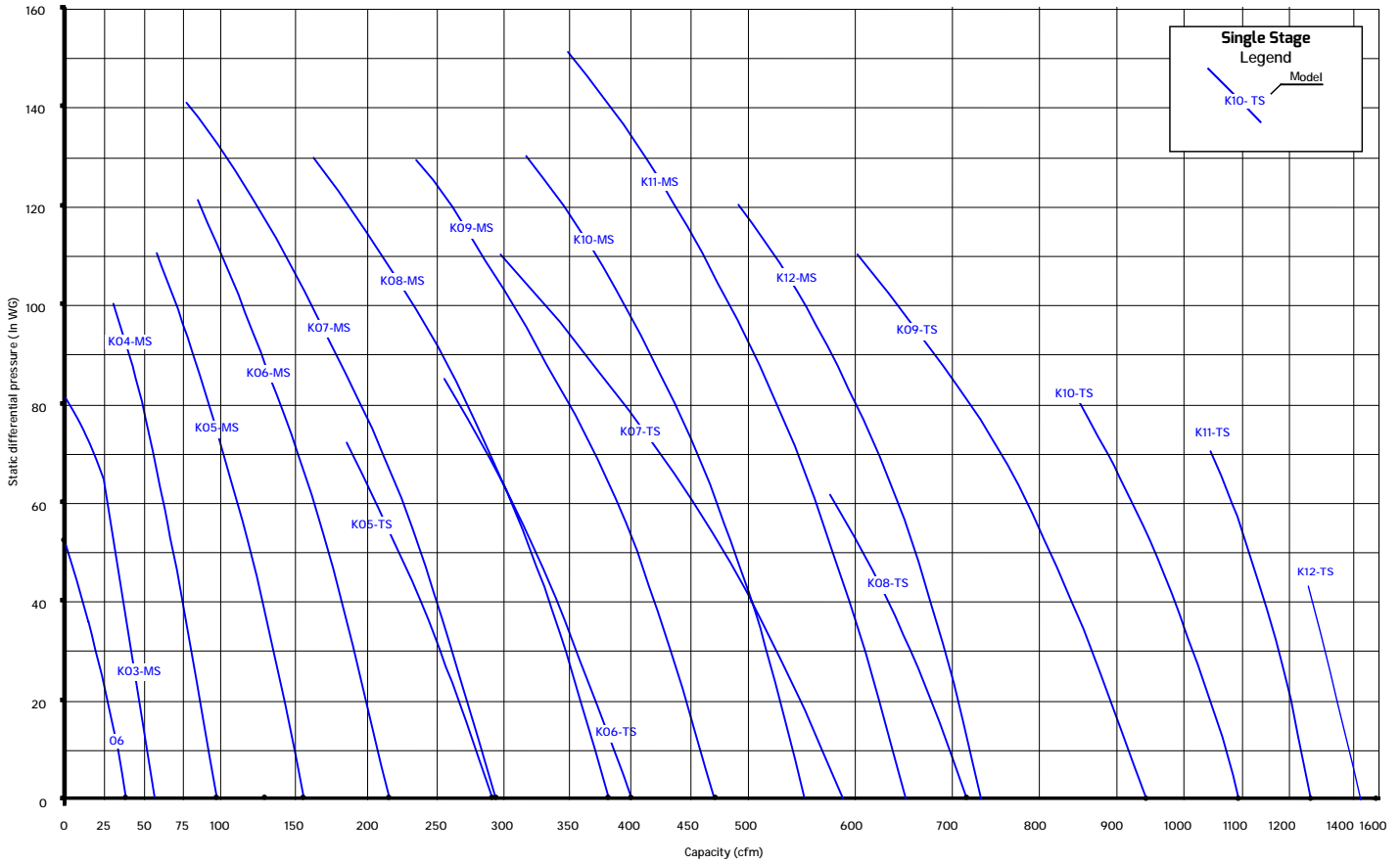

Curves refer to air at 68° F temperature, measured at inlet port and 29.92 In Hg atmospheric backpressure (abs).
 Tolerance on given values ± 10% - data can change without prior notice.



SCL K03 / K04 / K05 / K06

MS SERIES

SN 1874-15B 1/2

TECHNICAL CHARACTERISTICS

- Aluminium alloy construction
- Smooth operation
- High efficiency impeller
- Maintenance free
- Mountable in any position
- Recognized TEFC - cURus motor

OPTIONS

- Special voltages (IEC 38)
- Surface treatments

ACCESSORIES

- Inlet and/or inline filters
- Additional inlet/outlet silencers
- Safety valves
- Flow converting device
- Optional connectors

Dimensions in inches.

Dimension for reference only.

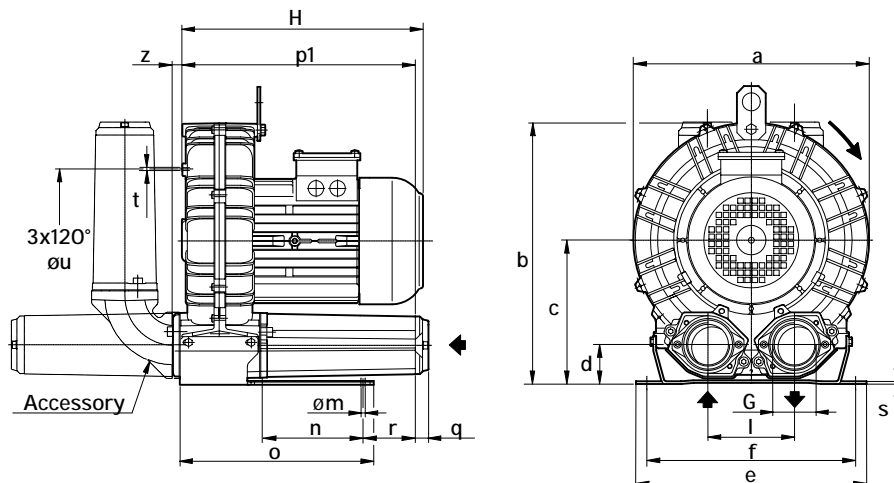

Model	a	b	c	d	e	f	G	l	m	n	o	p1	q	r	s	t	u	z
K03-MS	9.49	10.55	5.79	1.69	9.06	8.07	1 1/4 NPT	3.39	0.39	3.27	5.59	8.07	0.71	2.95	0.16	M6	5.51	0.47
K04-MS	11.22	12.40	6.77	1.93	10.04	8.86	1 1/2 NPT	4.02	0.47	3.74	6.73	8.74	0.71	2.76	0.16	M6	6.89	0.71
K05-MS	12.87	14.37	7.87	2.13	12.80	10.24	2" NPT	4.72	0.59	4.53	10.43	12.60	0.71	3.86	0.16	M8	7.87	0.75
K06-MS	14.80	15.47	8.07	2.13	12.80	11.42	2" NPT	4.92	0.59	5.51	10.71	13.15	0.71	3.35	0.16	M8	9.45	0.75

Model	Maximum flow Scfm		Installed power Hp		Maximum differential pressure Δp (In WG)		Noise level Lp dB (A) (1)		Overall dimensions H Inches	Weight Lbs
	60 Hz 3500 rpm	50 Hz 2900 rpm	60 Hz 3500 rpm	50 Hz 2900 rpm	60 Hz 3500 rpm	50 Hz 2900 rpm	60 Hz 3500 rpm	50 Hz 2900 rpm		
K03-MS	52	43	3/4	3/4	64	60	62.0	60.0	10.43	24.3
			1	1	95	72	62.3	60.3	12.0	32.0
K04-MS	98	81	1 1/2	1 1/2	58	80	64.8	62.8	11.65	40.3
			2	2	85	100	65.0	63.0	14.20	56.8
			3	-	120	-	65.2	-	14.20	58.4
K05-MS	156	129	2	2	52	70	70.5	68.5	13.20	56.7
			3	3	80	110	70.8	68.8	13.20	60.6
			4	4	120	120	71.1	69.1	14.40	77.2
K06-MS	216	179	3	3	40	65	73.0	71.0	13.80	69.0
			4	4	64	95	73.3	71.3	14.17	82.5
			5 1/2	5 1/2	110	130	73.6	71.6	15.5	85.3
			6 1/5	-	122	-	73.9	-	16.3	95.5

(1) Noise measured at 1 m distance with inlet and outlet ports piped, in accordance to ISO 3744.

- For proper use, the blower should be equipped with inlet filter and safety valve; other accessories available on request.
- Ambient temperature from +5° to +104°F.
- Specifications subject to change without notice.



SCL K03 / K04 / K05 / K06
MS SERIES
SN 1874-15B 2/2

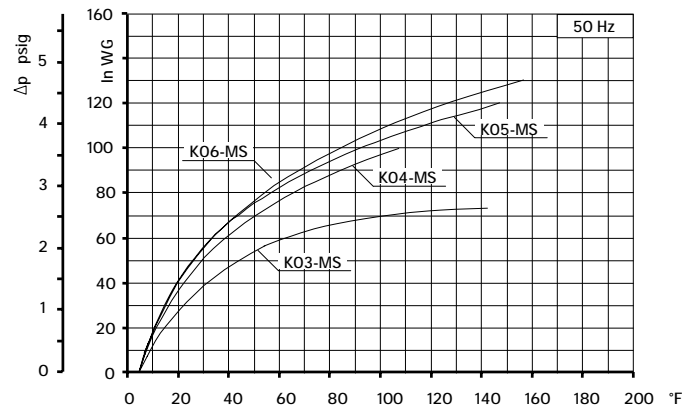
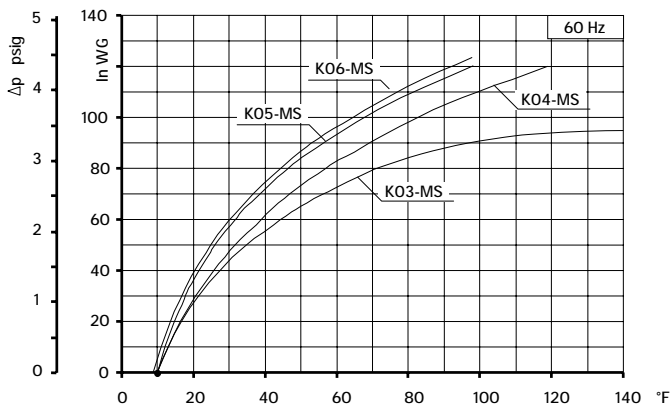
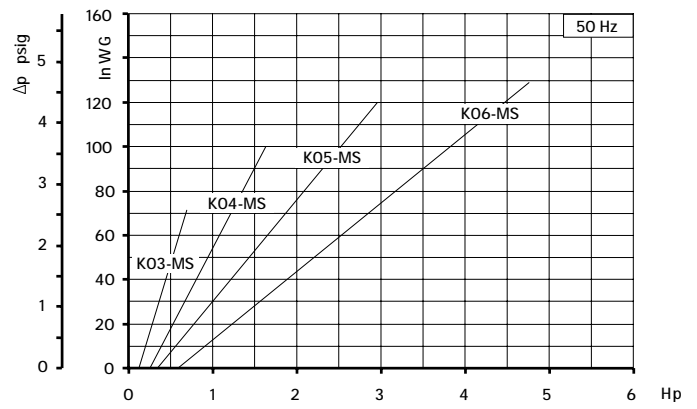
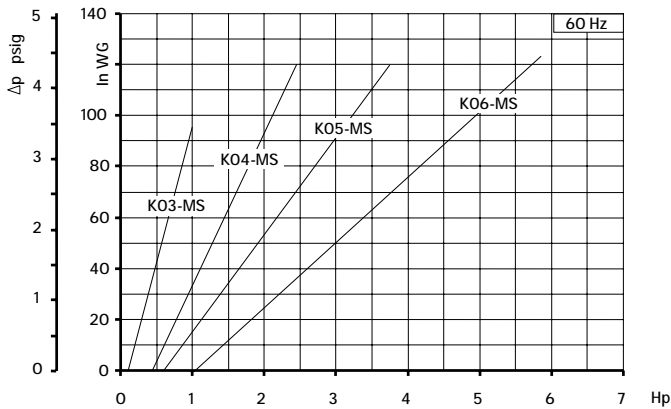
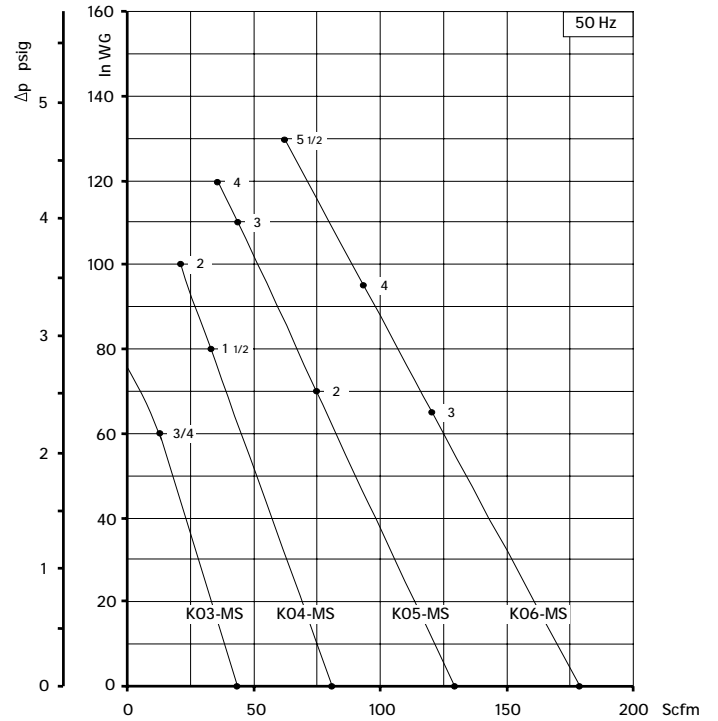
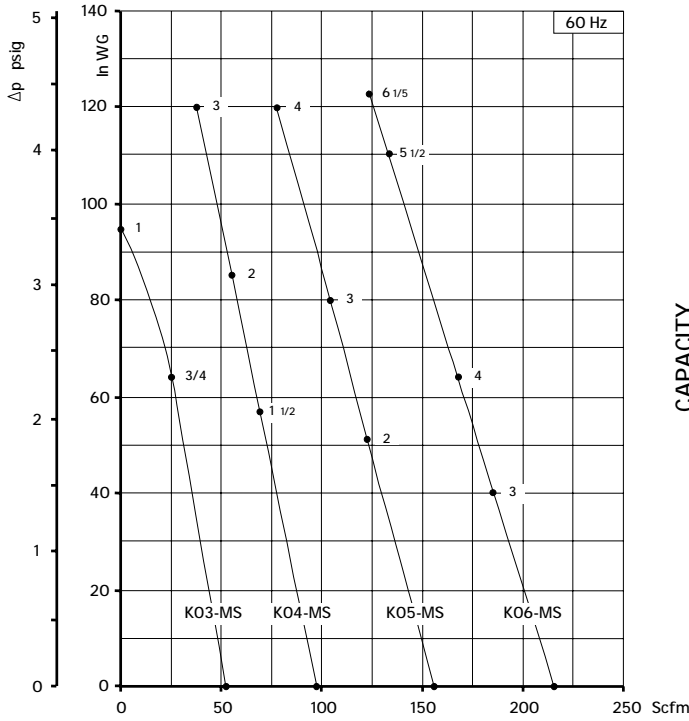

Curves refer to air at 68°F temperature and 29.92 In Hg atmospheric pressure (abs) measured at inlet port.
Values for flow, power consumption and temperature rise: +/- 10% tolerance.
Data subject to change without notice.



SCL K07 / K08 / K09 / K10 / K11 / K12

MS SERIES

SN1805-188 1/2

TECHNICAL CHARACTERISTICS

- Aluminium alloy construction
- Smooth operation
- High efficiency impeller
- Maintenance free
- Mountable in any position
- Recognized TEFC - cURus motor

OPTIONS

- Special voltages (IEC 38)
- Surface treatments

ACCESSORIES

- Inlet and/or inline filters
- Additional inlet/outlet silencers
- Safety valves
- Flow converting device
- Optional connectors

Dimensions in inches.

Dimension for reference only.

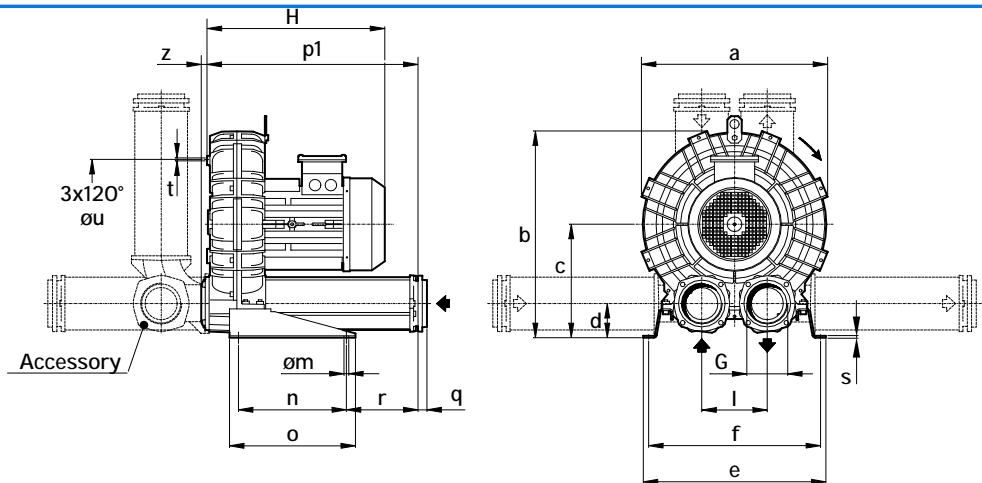

Model	a	b	c	d	e	f	G	l	m	n	o	p1	q	r	s	t	u	z
K07-MS	16.69	18.84	10.59	3.23	18.43	17.24	3" NPT	6.10	0.51	11.81	13.78	20.16	0.98	5.39	0.20	M8	11.61	0.63
K08-MS	17.99	19.61	10.59	3.23	18.82	17.64	3" NPT	6.10	0.51	11.81	13.78	20.16	0.98	5.39	0.20	M8	12.2	0.63
K09-MS	19.37	22.09	12.40	3.78	20.00	18.82	4" NPT	7.17	0.51	11.81	13.78	23.07	0.98	7.83	0.20	M8	14.17	0.63
K10-MS	20.31	22.56	12.40	3.78	20.00	18.82	4" NPT	7.17	0.51	11.81	13.78	23.07	0.98	7.83	0.20	M8	14.17	0.63
K11-MS	21.34	23.74	13.07	3.58	21.26	20.00	4" NPT	7.87	0.51	11.81	13.78	23.46	0.98	8.03	0.20	M8	15.35	0.63
K12-MS	21.57	23.82	13.07	3.58	21.26	20.00	4" NPT	7.87	0.51	11.81	13.78	23.58	0.98	8.03	0.20	M8	15.35	0.51

Model	Maximum flow Scfm		Installed power Hp		Maximum differential pressure Δp (In WG)		Noise level Lp d B (A) ⁽¹⁾		Overall dimensions H	Weight
	60 Hz 3500 rpm	50 Hz 2900 rpm	60 Hz 3500 rpm	50 Hz 2900 rpm	60 Hz 3500 rpm	50 Hz 2900 rpm	60 Hz 3500 rpm	50 Hz 2900 rpm		
	Inches		Lbs							
K07-MS	294	243	4	4	50	80	78.7	76.7	15.6	116.2
			5 1/2	5 1/2	80	110	79.0	77.0	16.3	119.0
			7 1/2	7 1/2	121	141	79.3	77.3	18.4	160.5
			10	10	171	-	79.6	77.6	19.1	172.6
K08-MS	381	316	5 1/2	5 1/2	40	70	79.7	77.7	16.3	124.8
			7 1/2	7 1/2	70	100	80.0	78.0	18.4	166.5
			10	10	111	141	80.3	78.3	19.1	179.0
			15	15	171	171	80.6	78.6	19.1	192.0
K09-MS	471	390	7 1/2	7 1/2	50	80	80.2	78.2	18.8	186.3
			10	10	80	120	80.5	78.5	19.5	199.0
			15	15	141	171	81.0	79.0	19.6	212.0
			20	20	171	-	81.3	79.3	22.0	245.0
K10-MS	556	460	7 1/2	7 1/2	30	60	80.1	78.1	18.8	189.6
			10	10	50	90	80.5	78.5	19.5	202.0
			15	15	111	141	81.0	79.0	19.6	215.0
			20	20	161	171	81.4	79.4	22.0	248.0
			25	25	201	-	81.6	79.6	24.0	322.0
K11-MS	650	539	15	15	70	110	82.4	80.4	19.8	226.0
			20	20	121	160	82.7	80.7	22.5	259.0
			25	25	151	181	85.6	83.6	24.0	333.0
K12-MS	726	602	15	15	50	90	82.9	80.9	19.9	229.5
			20	20	90	130	83.2	81.2	22.5	263.0
			25	25	121	161	86.1	84.1	24.0	337.0

(1) Noise measured at 1 m distance with inlet and outlet ports piped, in accordance to ISO 3744.

- For proper use, the blower should be equipped with inlet filter and safety valve; other accessories available on request.
- Ambient temperature from +5° to +104°F.
- Specifications subject to change without notice.



SCL K07 / K08 / K09 / K10 / K11 / K12

MS SERIES

SN1805-18B 2/2

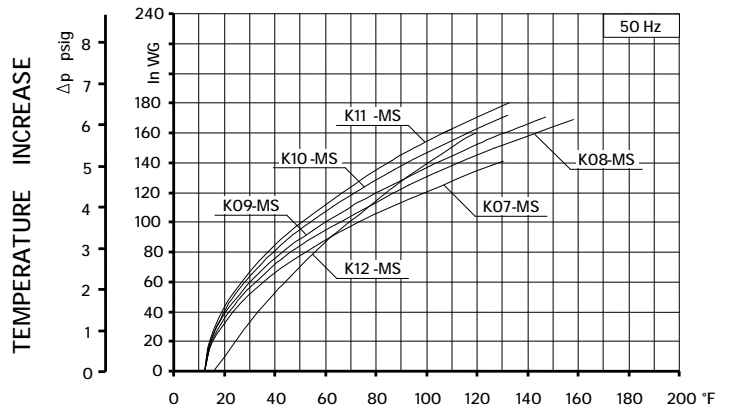
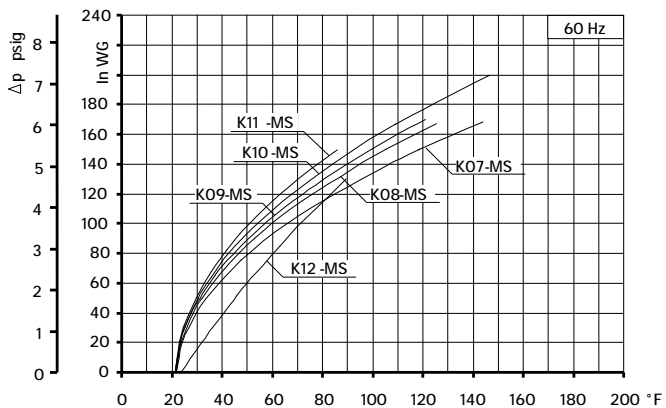
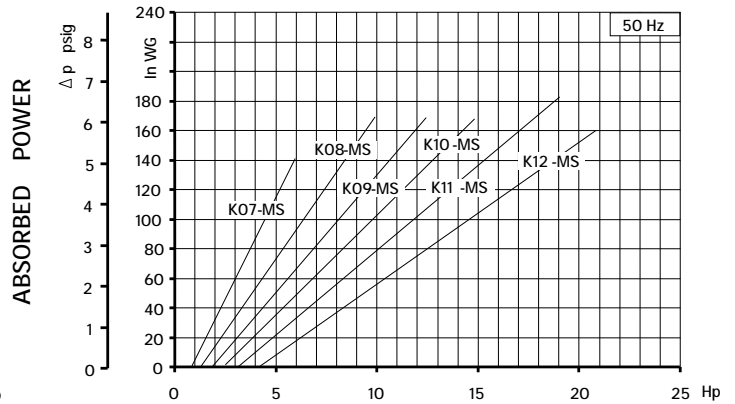
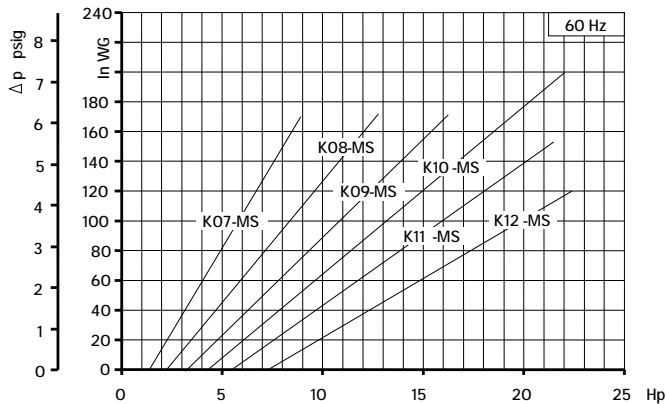
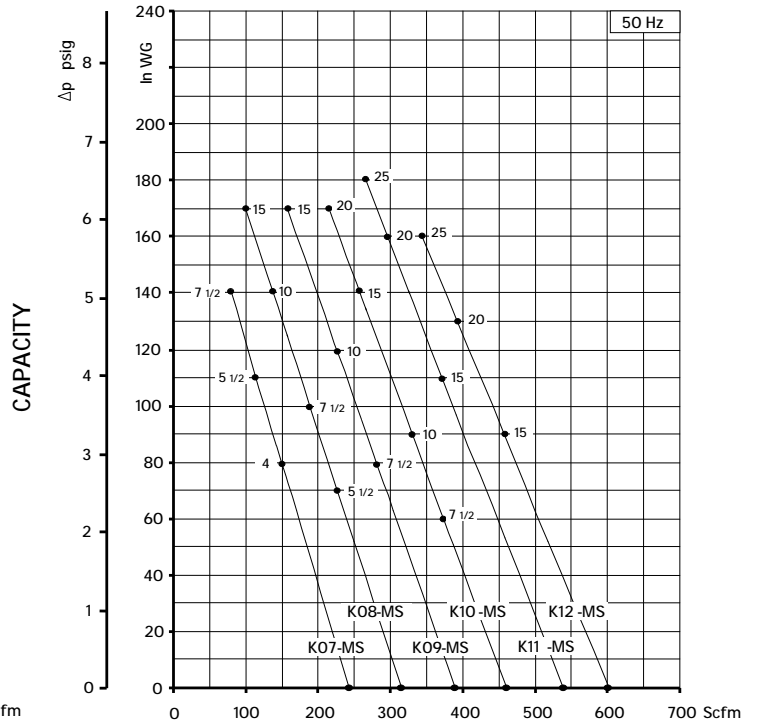
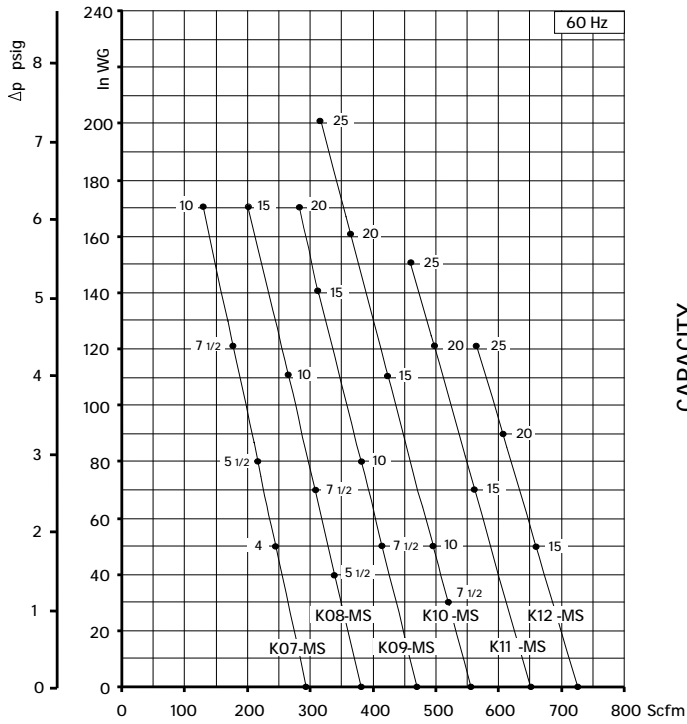

Curves refer to air at 68°F temperature and 29.92 In Hg atmospheric pressure (abs) measured at inlet port.
 Values for flow, power consumption and temperature rise: +/- 10% tolerance.
 Data subject to change without notice.



SCL K05 / K06

TS SERIES

SN 1921-9B 1/2

TECHNICAL CHARACTERISTICS

- Aluminium alloy construction
- Smooth operation
- High efficiency impeller
- Maintenance free
- Mountable in any position
- Recognized TEFC - cURus motor 3x120°øu

OPTIONS

- Special voltages (IEC 38)
- Surface treatments

ACCESSORIES

- Inlet and/or inline filters
- Additional inlet/outlet silencers
- Safety valves
- Flow converting device
- Optional connectors

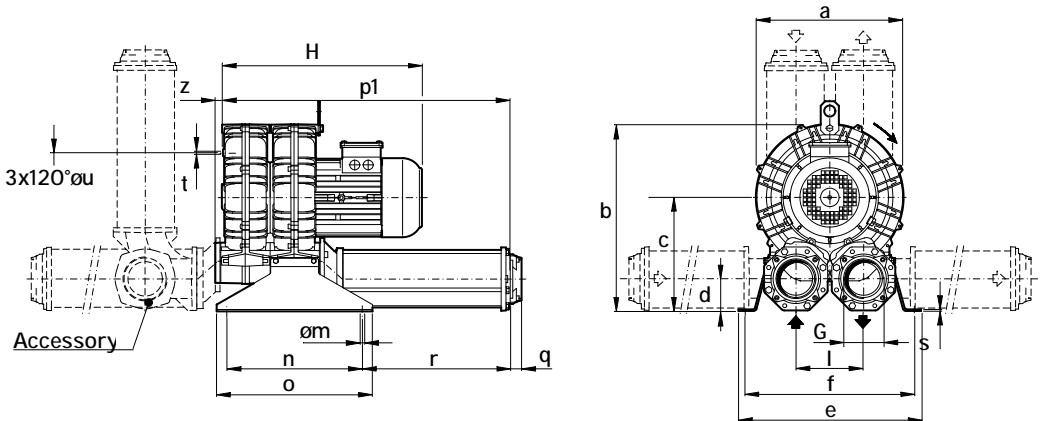

Dimensions in inches.

Dimension for reference only.

Model	a	b	c	d	e	f	G	l	m	n	o	p1	q	r	s	t	u	z
K05-TS	12.87	16.61	10.16	3.03	15.91	14.72	3" NPT	5.91	0.51	11.81	13.58	24.96	0.98	12.91	0.16	M8	7.87	0.75
K06-TS	14.80	17.72	10.31	2.95	15.91	14.72	3" NPT	6.10	0.51	11.81	13.58	26.06	0.98	13.19	0.16	M8	9.45	0.75

Model	Maximum flow Scfm		Installed power Hp		Maximum differential pressure Δp (In WG)		Noise level Lp dB (A) (1)		Overall dimensions H Inches	Weight Lbs
	60 Hz 3500 rpm	50 Hz 2900 rpm	60 Hz 3500 rpm	50 Hz 2900 rpm	60 Hz 3500 rpm	50 Hz 2900 rpm	60 Hz 3500 rpm	50 Hz 2900 rpm		
K05-TS	290	241	5 ½	5 ½	72	100	75.5	73.5	19.5	109.0
K06-TS	400	331	5 ½	5 ½	36	55	77.2	75.2	19.7	122.8
			7 ½	7 ½	55	80	77.5	75.5	23.0	168.8
			10	10	85	111	77.8	75.8	24.5	181.0

(1) Noise measured at 1 m distance with inlet and outlet ports piped, in accordance to ISO 3744.

- For proper use, the blower should be equipped with inlet filter and safety valve; other accessories available on request.
- Ambient temperature from +5° to +104°F.
- Specifications subject to change without notice.



SCL K05 / K06
TS SERIES
SN 1921-9B 2/2

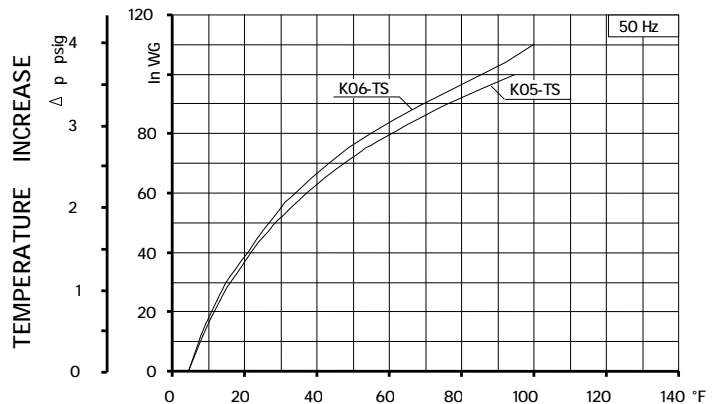
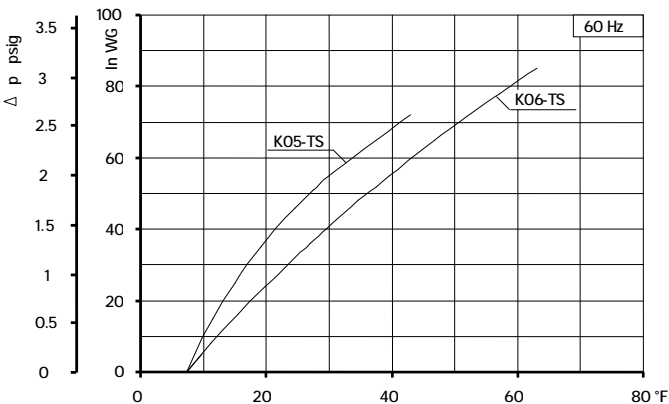
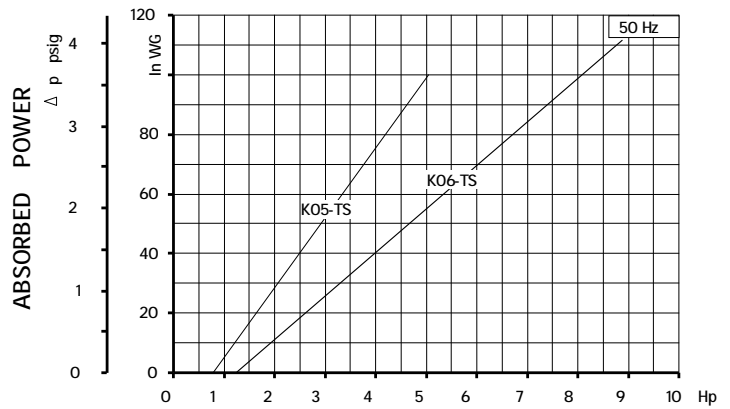
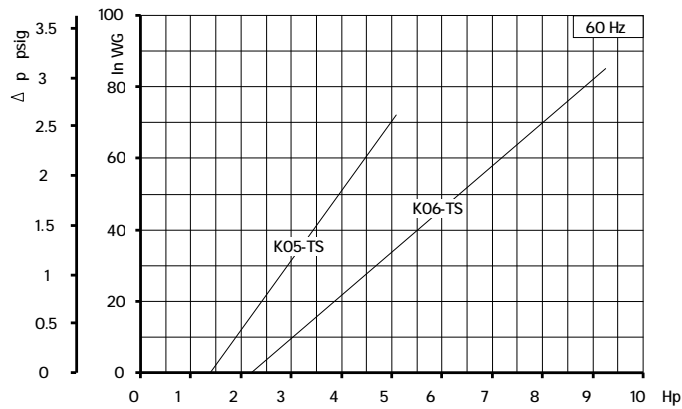
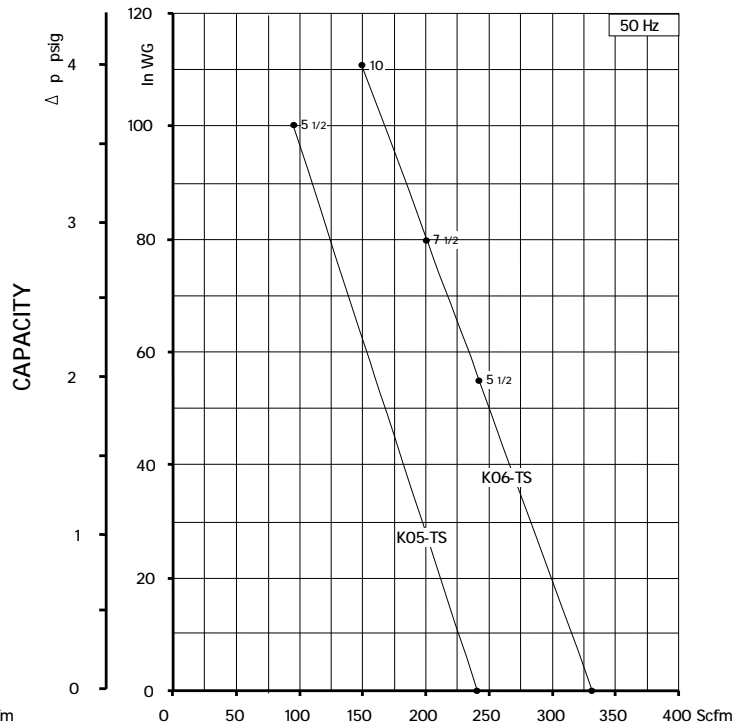
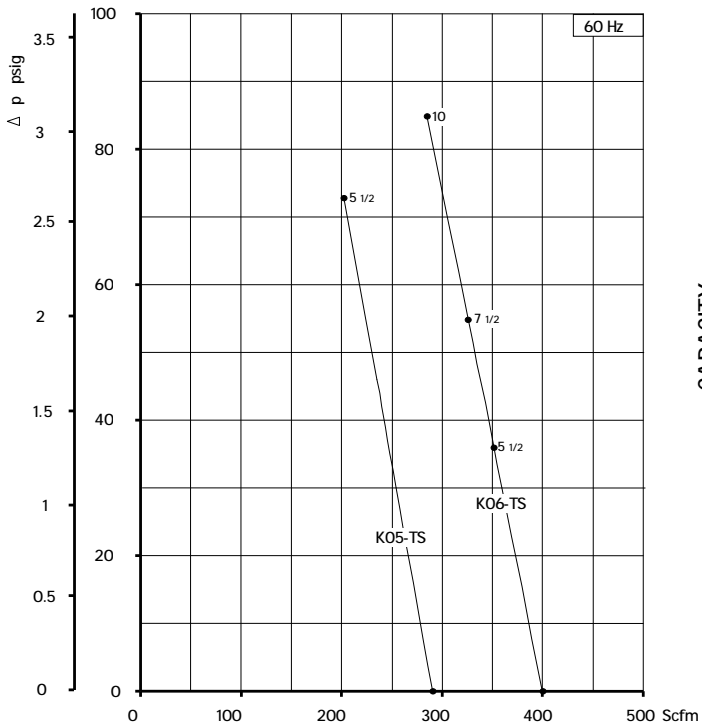

Curves refer to air at 68°F temperature and 29.92 In Hg atmospheric pressure (abs) measured at inlet port.
Values for flow, power consumption and temperature rise: +/-10% tolerance.
Data subject to change without notice.



SCL K07 / K08 / K09 / K10 / K11 / K12

TS SERIES
SN 1822-17B 1/2

TECHNICAL CHARACTERISTICS

- Aluminium alloy construction
- Smooth operation
- High efficiency impeller
- Maintenance free
- Mountable in any position
- Recognized TEFC - cURus motor
- G 1/8" female thread on both suction and discharge silencer port flanges

OPTIONS

- Special voltages (IEC 38)
- Surface treatments

ACCESSORIES

- Inlet and/or inline filters
- Additional inlet/outlet silencers
- Safety valves
- Flow converting device
- Optional connectors

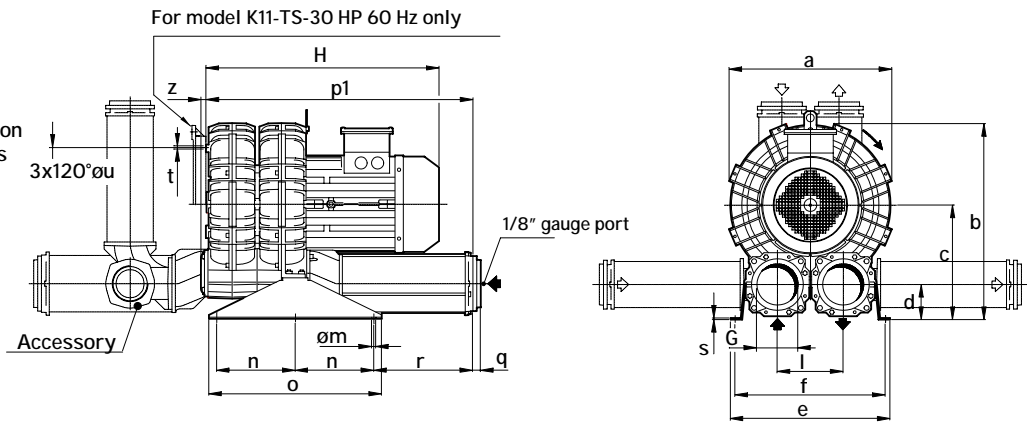

Dimensions in inches.

Dimension for reference only.

Model	a	b	c	d	e	f	G	l	m	n	o	p1	q	r	s	t	u	z
K07-TS	16.69	20.91	12.56	3.86	18.50	17.24	4" NPT	7.17	0.51	9.84	21.65	31.57	0.98	11.77	0.20	M8	11.61	0.63
K08-TS	17.99	21.57	12.56	3.86	18.90	17.64	4" NPT	7.17	0.51	9.84	21.65	31.57	0.98	11.77	0.20	M8	12.20	0.63
K09-TS	19.37	24.02	14.37	4.41	20.08	18.82	5" NPT	8.27	0.51	9.84	21.65	33.46	1.38	12.40	0.20	M8	14.17	0.63
K10-TS	20.31	24.53	14.37	4.41	20.08	18.82	5" NPT	8.27	0.51	9.84	21.65	33.46	1.38	12.40	0.20	M8	14.17	0.63
K11-TS	21.34	25.59	14.96	4.17	21.26	20.00	5" NPT	8.98	0.51	9.84	21.65	34.25	1.38	12.60	0.20	M8	15.35	0.63
K12-TS	21.57	25.71	14.96	4.17	21.26	20.00	5" NPT	8.98	0.51	9.84	21.65	34.8	1.38	12.60	0.20	M8	15.4	0.63

Model	Maximum flow Scfm		Installed power Hp		Maximum differential pressure Δp (In WG)		Noise level Lp dB (A) (1)		Overall dimensions H Inches	Weight Lbs
	60 Hz 3500 rpm	50 Hz 2900 rpm	60 Hz 3500 rpm	50 Hz 2900 rpm	60 Hz 3500 rpm	50 Hz 2900 rpm	60 Hz 3500 rpm	50 Hz 2900 rpm		
K07-TS	588	487	7 1/2	7 1/2	36	60	83.9	81.9	23.0	218.3
			10	10	50	90	84.2	82.2	24.5	230.4
			15	15	100	131	84.8	82.8	24.5	243.7
K08-TS	715	592	15	15	60	90	83.3	81.3	24.5	256.0
			20	20	80	100	85.0	83.0	31.0	422.0
K09-TS	941	780	25	25	110	141	87.0	85.0	31.0	432.0
			20	20	50	80	88.1	86.1	31.0	429.0
K10-TS	1093	906	25	25	80	100	88.4	86.4	31.0	439.0
			25	25	46	90	89.4	87.4	31.5	469.0
K11-TS	1254	1039	30	30	70	111	90.0	88.0	31.5	475.0
			30	30	45	80	90.6	88.6	32.0	475.0

(1) Noise measured at 1 m distance with inlet and outlet ports piped, in accordance to ISO 3744.

(2) K11-TS-30 HP vertical assembly only.

- For proper use, the blower should be equipped with inlet filter and safety valve; other accessories available on request.
- Ambient temperature from +5° to +104°F.
- Specifications subject to change without notice.



SCL K07 / K08 / K09 / K10 / K11 / K12

TS SERIES
SN 1822-17B 2/2

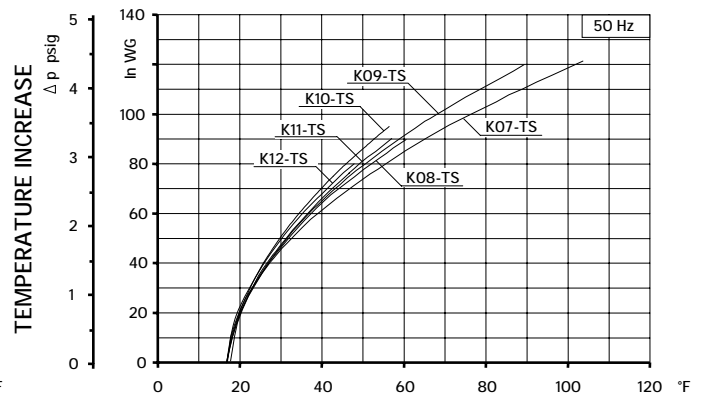
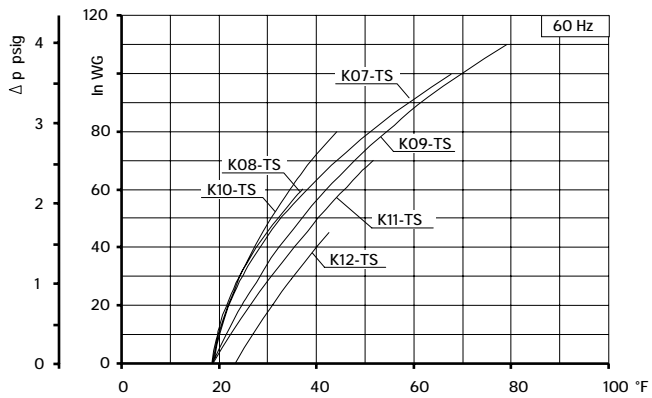
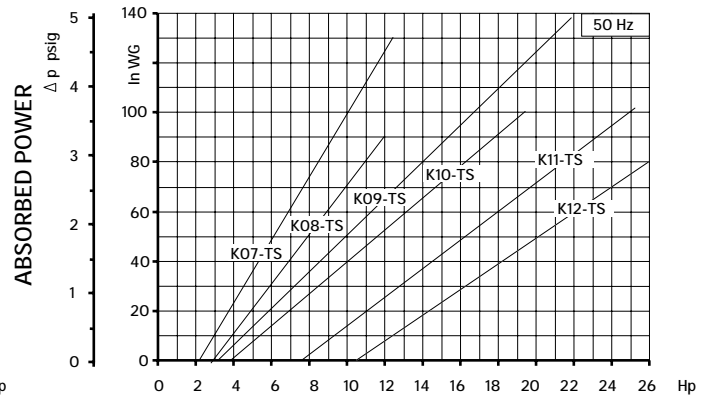
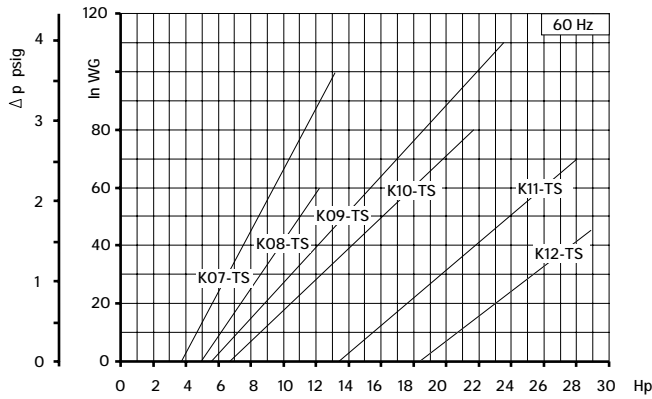
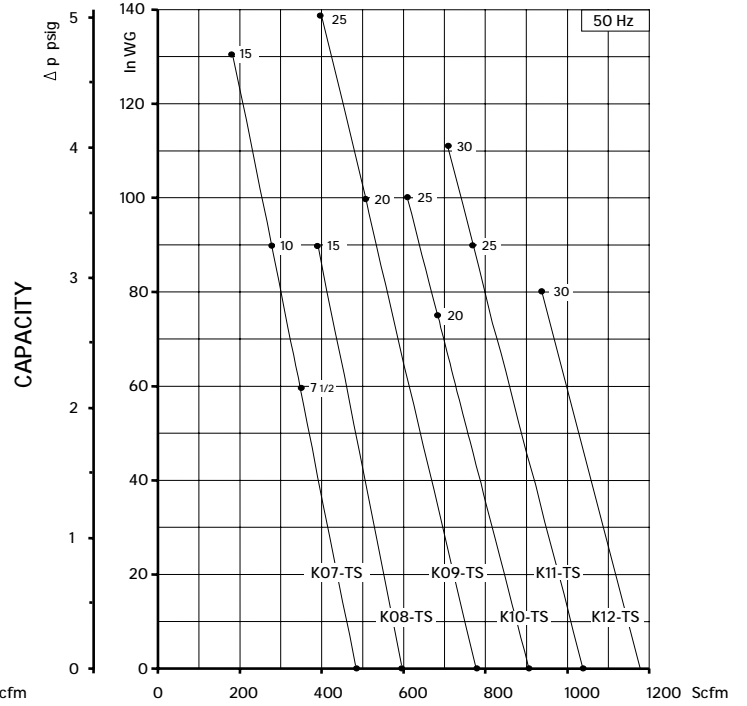
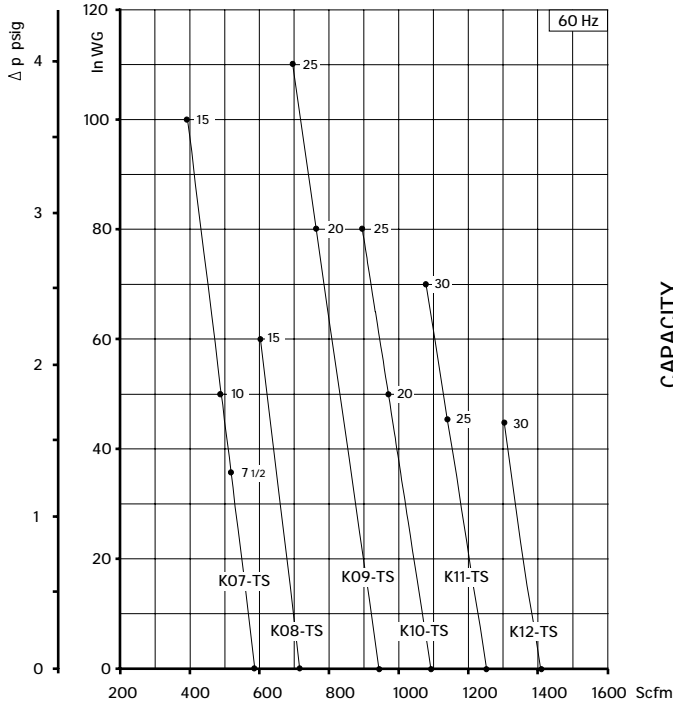

Curves refer to air at 68°F temperature and 29.92 In Hg atmospheric pressure (abs) measured at inlet port.
Values for flow, power consumption and temperature rise: +/-10% tolerance.
Data subject to change without notice.



TECHNICAL CHARACTERISTICS

- Aluminium alloy construction
- Smooth operation
- High efficiency impeller
- Maintenance free
- Mountable in any position
- Recognized TEFC - cURus motor

OPTIONS

- Special voltages (IEC 38)
- Surface treatments

ACCESSORIES

- Inlet and/or inline filters
- Additional inlet/outlet silencers
- Safety valves
- Flow converting device
- Optional connectors

Dimensions in inches.
Dimension for reference only.

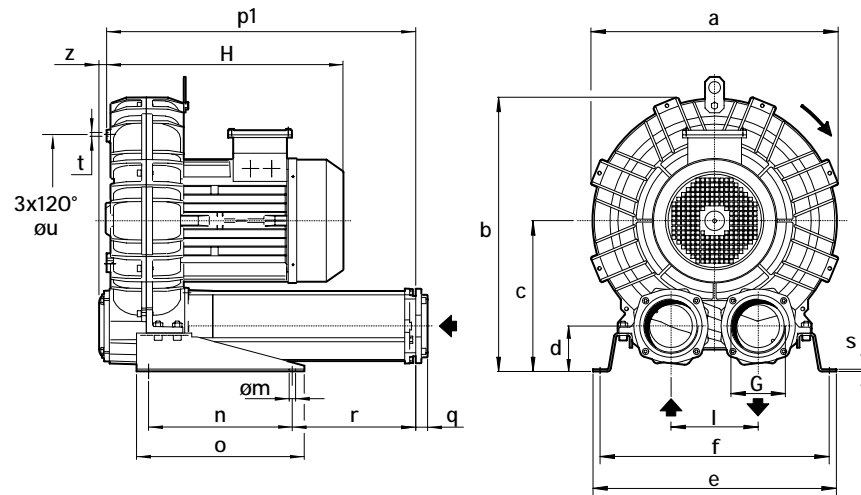

Model	a	b	c	d	e	f	G	l	m	n	o	p1	q	r	s	t	u	z
K07R-MD	16.69	18.94	10.59	3.23	18.43	17.24	2" NPT	6.10	0.51	11.81	31.78	16.46	0.71	1.70	0.20	M8	11.61	0.63
K08R-MD	17.99	19.61	10.59	3.23	18.82	17.64	2" NPT	6.10	0.51	11.81	13.78	16.46	0.71	1.70	0.20	M8	12.20	0.63
K09-MD	19.37	22.09	12.40	3.78	20.00	18.82	4" NPT	7.17	0.51	11.81	13.78	25.35	0.98	10.12	0.20	M8	14.17	0.63
K10-MD	20.31	22.56	12.40	3.78	20.00	18.82	4" NPT	7.17	0.51	11.81	13.78	25.35	0.98	10.12	0.20	M8	14.17	0.63
K11-MD	21.35	23.74	13.07	3.58	21.18	20.00	4" NPT	7.87	0.51	11.81	13.78	25.75	0.98	10.31	0.20	M8	15.35	0.63
K12-MD	21.57	23.85	13.07	3.58	21.18	20.00	4" NPT	7.87	0.51	11.81	13.78	25.87	0.98	10.31	0.20	M8	15.35	0.62

Model	Maximum flow Scfm		Installed power Hp		Maximum differential pressure Δp (In WG)		Noise level Lp dB (A) (1)		Overall dimensions H Inches	Weight Lbs
	60 Hz 3500 rpm	50 Hz 2900 rpm	60 Hz 3500 rpm	50 Hz 2900 rpm	60 Hz 3500 rpm	50 Hz 2900 rpm	60 Hz 3500 rpm	50 Hz 2900 rpm		
K07R-MD	129	107	5 1/2	5 1/2	150	220	74.5	72.5	16.30	117
			7 1/2	7 1/2	231	260	75.0	73.0	17.60	159
			10	10	280	-	75.0	73.0	19.10	171
K08R-MD	168	139	5 1/2	5 1/2	85	140	76.2	74.2	16.30	125
			7 1/2	7 1/2	151	200	76.6	74.6	17.60	167
			10	10	220	260	77.0	75.0	19.10	179
K09-MD	221	183	15	-	260	-	77.3	-	19.10	192
			10	10	190	250	79.5	77.5	19.50	210
K10-MD	275	228	15	15	290	-	80.5	78.5	19.50	223
			10	10	130	200	80.3	78.3	19.50	214
K11-MD	306	254	15	15	240	260	81.4	79.4	19.50	228
			20	20	260	-	81.7	79.7	22.00	264
K12-MD	336	278	15	15	180	260	81.4	79.4	19.70	244
			20	20	280	-	81.7	79.7	22.50	280
			25	-	100	180	82.3	80.3	19.90	242
			20	20	180	260	82.6	80.6	22.50	278
			25	-	240	-	82.9	-	25.00	362

(1) Noise measured at 1 m distance with inlet and outlet ports piped, in accordance to ISO 3744.

- For proper use, the blower should be equipped with inlet filter and safety valve; other accessories available on request.
- Ambient temperature from +5° to +104°F.
- Specifications subject to change without notice.



SCL K07R / K08R / K09 / K10 / K11 / K12
MD SERIES
SN 1848-12B 2/2

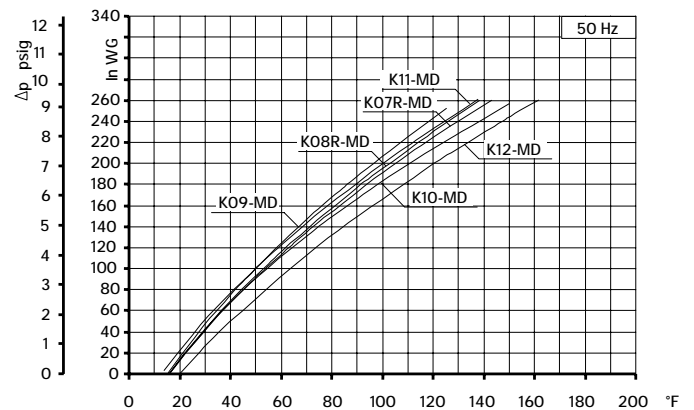
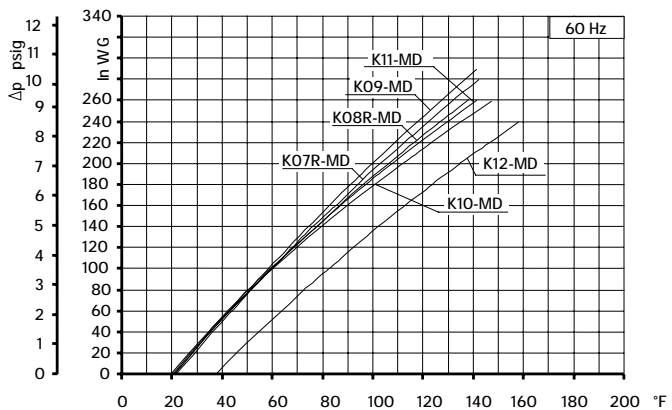
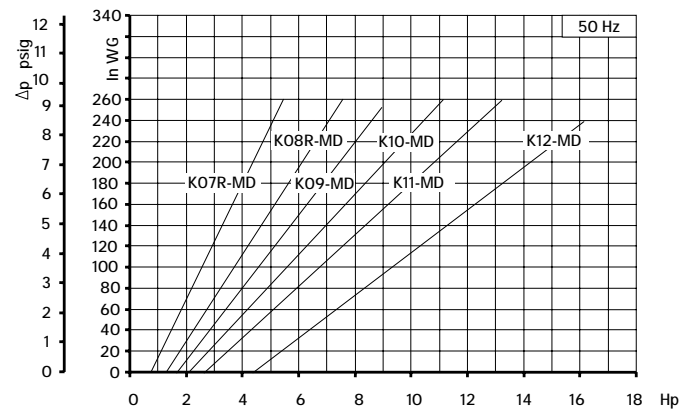
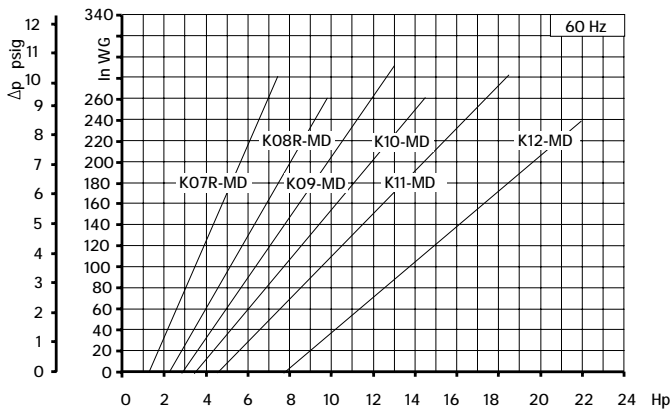
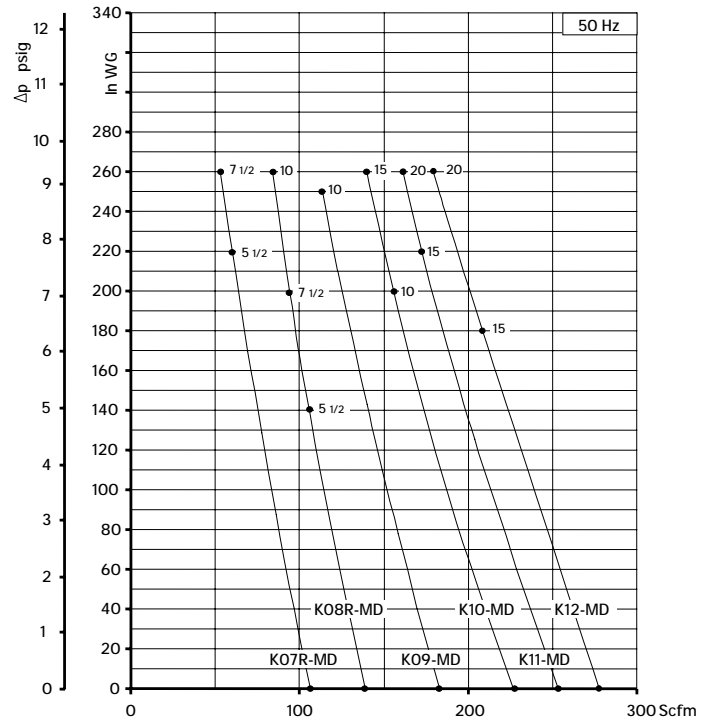
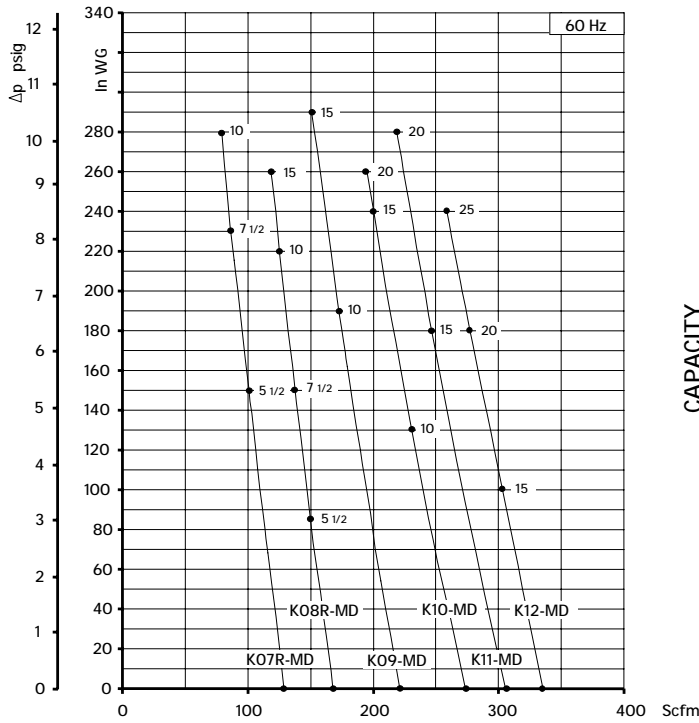

Curves refer to air at 68°F temperature and 29.92 In Hg atmospheric pressure (abs) measured at inlet port.
Values for flow, power consumption and temperature rise: +/-10% tolerance.
Data subject to change without notice.



SCL K05 / K06

TD SERIES

SN 1931-9B 1/2

TECHNICAL CHARACTERISTICS

- Aluminium alloy construction
- Smooth operation
- High efficiency impeller
- Maintenance free
- Mountable in any position
- Recognized TEFC - cURus motor

OPTIONS

- Special voltages (IEC 38)
- Surface treatments

ACCESSORIES

- Inlet and/or inline filters
- Additional inlet/outlet silencers
- Safety valves
- Flow converting device
- Optional connectors

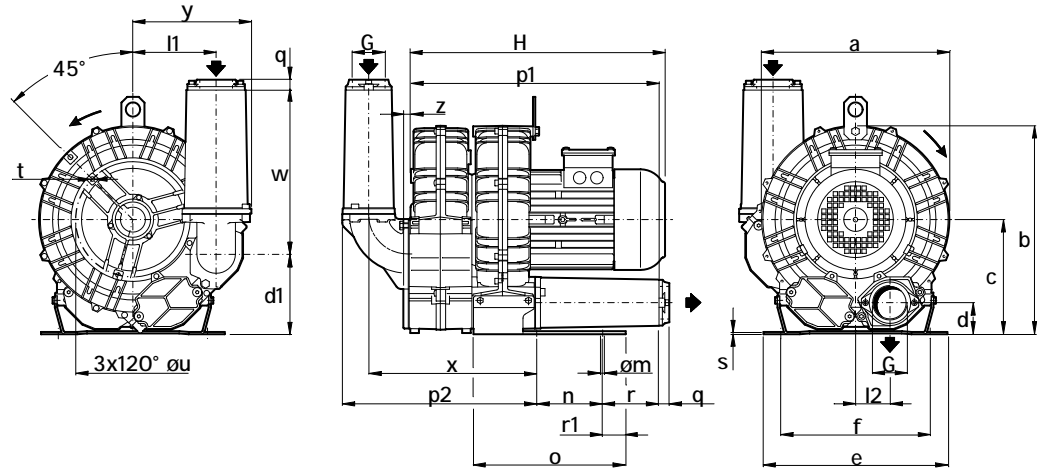

Dimensions in inches.

Dimension for reference only.

Model	a	b	c	d	d1	e	f	G	l1	l2	m	n	o	p1	p2	q	r	r1	s	t	u	w	x	y	z
K05-TD	12.87	14.37	7.87	2.13	5.51	12.60	10.24	2" NPT	5.71	2.36	0.59	4.53	10.43	16.85	13.39	0.71	3.86	1.57	0.16	M8	7.87	11.26	11.54	8.11	0.75
K06-TD	14.80	16.54	9.13	2.32	6.69	12.80	11.42	2" NPT	5.94	2.87	0.59	5.51	10.43	19.92	13.94	0.71	5.35	0.75	0.16	M8	9.45	11.26	12.13	8.27	0.75

Model	Maximum flow Scfm		Installed power Hp		Maximum differential pressure Δp (In WG)		Noise level Lp dB (A) ⁽¹⁾		Overall dimensions H	Weight
	60 Hz 3500 rpm	50 Hz 2900 rpm	60 Hz 3500 rpm	50 Hz 2900 rpm	60 Hz 3500 rpm	50 Hz 2900 rpm	60 Hz 3500 rpm	50 Hz 2900 rpm		
	Inches									Lbs
K05-TD	153	127	5 1/2	5 1/2	150	190	76.0	74.0	19.5	101.0
K06-TD	222	184	10	10	180	220	77.0	75.0	24.5	174.5

(1) Noise measured at 1 m distance with inlet and outlet ports piped, in accordance to ISO 3744.

- For proper use, the blower should be equipped with inlet filter and safety valve; other accessories available on request.
- Ambient temperature from +5° to +104°F.
- Specifications subject to change without notice.



SCL K05 / K06
TD SERIES

SN 1931-9B 2/2

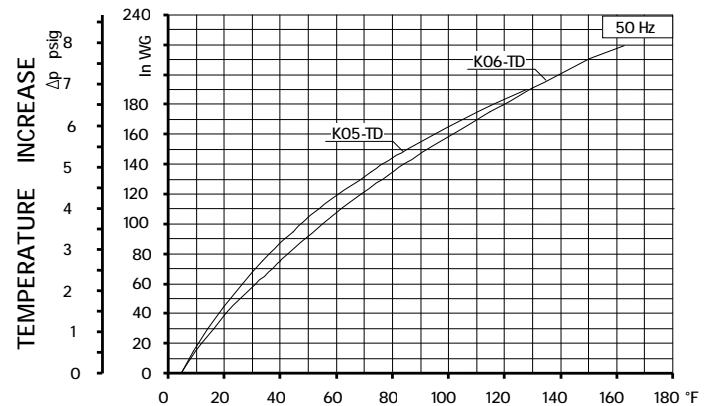
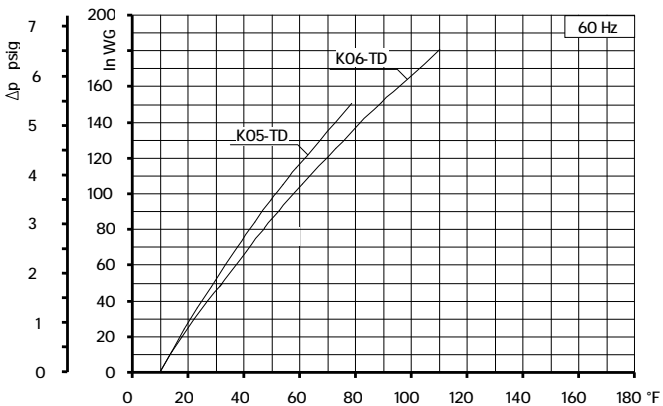
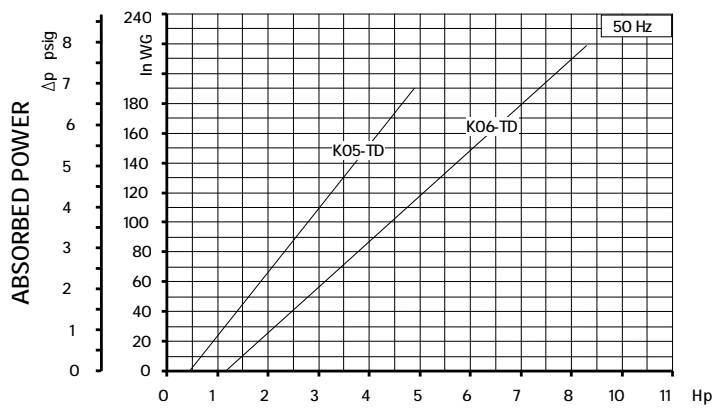
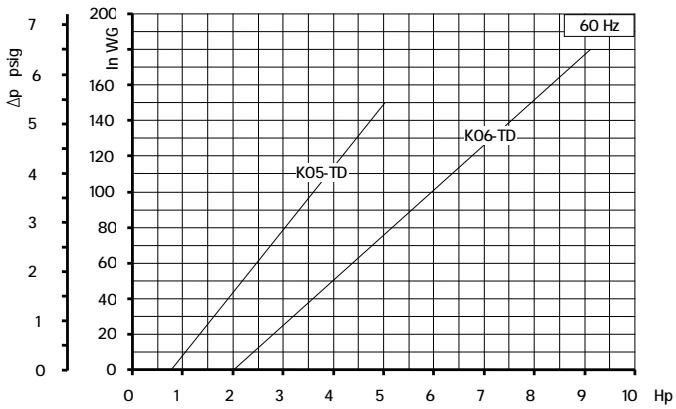
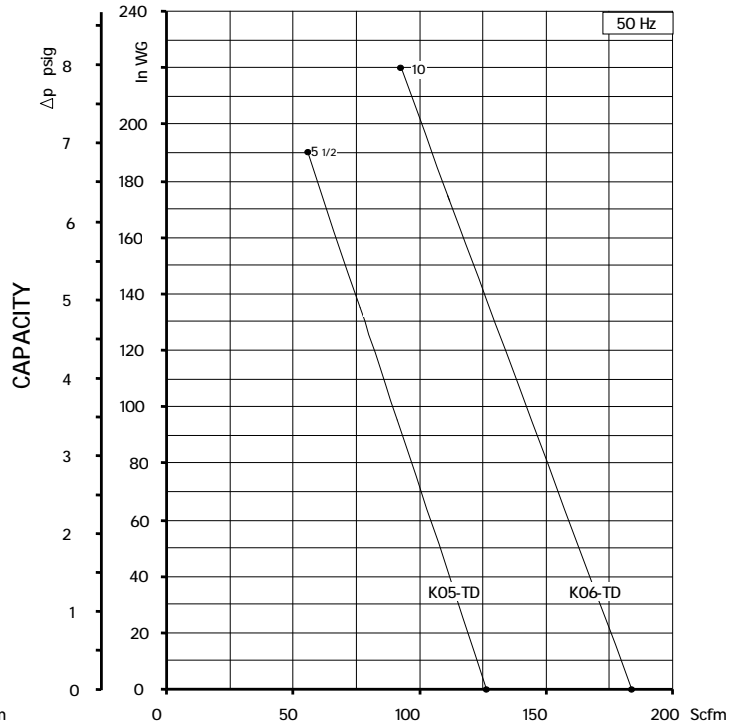
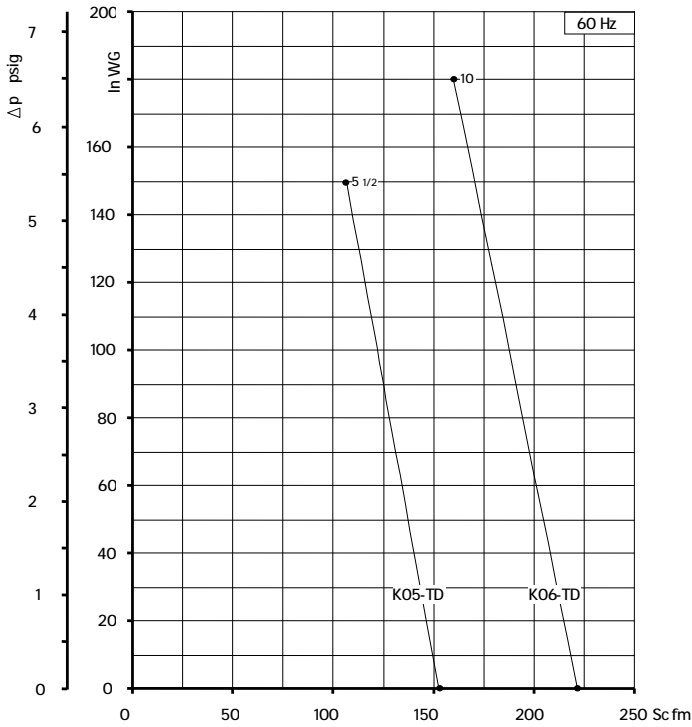

Curves refer to air at 68°F temperature and 29.92 In Hg atmospheric pressure (abs) measured at inlet port.
Values for flow, power consumption and temperature rise +/-10% tolerance.
Data subject to change without notice.



SCL K07 / K08 / K09 / K10 / K11 / K12

TD SERIES
SN 1830-13B 1/2

TECHNICAL CHARACTERISTICS

- Aluminium alloy construction
- Smooth operation
- High efficiency impeller
- Maintenance free
- Mountable in any position
- Recognized TEFC - cURus motor
- G1/8" female thread on both suction and discharge silencer port flanges

OPTIONS

- Special voltages (IEC 38)
- Surface treatments

ACCESSORIES

- Inlet and/or inline filters
- Additional inlet/outlet silencers
- Safety valves
- Flow converting device
- Optional connectors

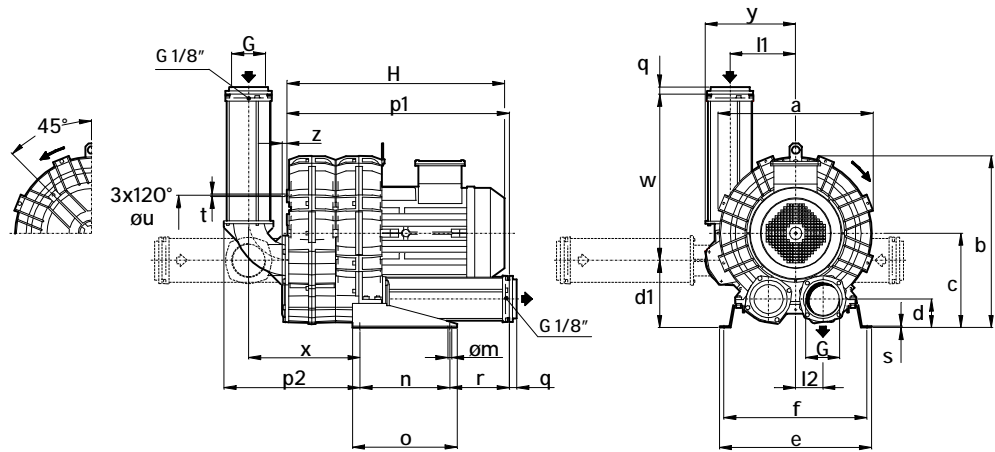

Dimensions in inches.
Dimension for reference only.

Model	a	b	c	d	d1	e	f	G	l1	l2	m	n	o	p1	p2	q	r	s	t	u	w	x	y	z
K07-TD	16.69	18.94	10.59	3.23	7.56	18.43	17.24	3"NPT	7.36	3.05	0.51	11.81	13.78	25.55	15.43	0.98	5.39	0.20	M8	11.61	18.94	12.56	10.24	0.63
K08-TD	17.99	19.61	10.59	3.23	7.56	18.82	17.64	3"NPT	7.36	3.05	0.51	11.81	13.78	25.55	15.43	0.98	5.39	0.20	M8	12.20	18.94	12.56	10.24	0.63
K09-TD	19.37	22.09	12.4	3.78	8.86	20.00	18.82	4"NPT	8.66	3.58	0.51	11.81	13.78	29.33	17.91	0.98	7.83	0.20	M8	14.17	21.89	14.65	11.89	0.63
K10-TD	20.31	22.56	12.4	3.78	8.86	20.00	18.82	4"NPT	8.66	3.58	0.51	11.81	13.78	29.33	17.91	0.98	7.83	0.20	M8	14.17	21.89	14.65	11.89	0.63
K11-TD	21.26	23.70	13.07	3.54	9.13	21.18	20.00	4"NPT	9.53	3.94	0.51	11.81	13.78	30.12	18.50	0.98	8.03	0.20	M8	15.35	21.89	15.24	12.76	0.63
K12-TD	21.57	23.81	13.07	3.54	9.13	21.18	20.00	4"NPT	9.53	3.94	0.51	11.81	13.78	30.23	18.50	0.98	8.03	0.20	M8	15.35	21.89	15.24	12.76	0.63

Model	Maximum flow Scfm		Installed power Hp		Maximum differential pressure Δp (In WG)		Noise level Lp dB (A) (1)		Overall dimensions H Inches	Weight Lbs
	60 Hz 3500 rpm	50 Hz 2900 rpm	60 Hz 3500 rpm	50 Hz 2900 rpm	60 Hz 3500 rpm	50 Hz 2900 rpm	60 Hz 3500 rpm	50 Hz 2900 rpm		
K07-TD	296	245	15	15	220	220	81.8	79.8	24.5	234.8
K08-TD	368	305	15	15	160	220	81.5	79.5	24.5	248.5
K09-TD	467	387	25	25	220	240	83.3	81.3	30.0	406.0
K10-TD	571	473	25	25	180	231	87.2	85.2	30.0	416.0
K11-TD	642	532	25	25	120	180	87.9	85.9	30.5	442.0
K12-TD	716	593	30	30	100	171	88.7	86.7	31.0	443.0

(1) Noise measured at 1 m distance with inlet and outlet ports piped, in accordance to ISO 3744.

- For proper use, the blower should be equipped with inlet filter and safety valve; other accessories available on request.
- Ambient temperature from +5° to +104°F.
- Specifications subject to change without notice.



SCL K07 / K08 / K09 / K10 / K11 / K12
TD SERIES
SN 1830-13B 2/2

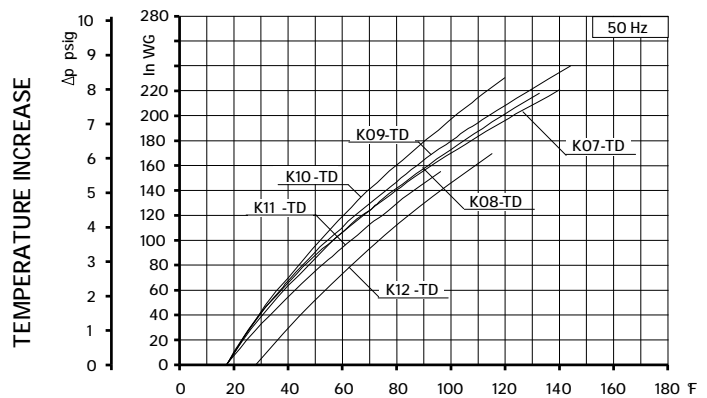
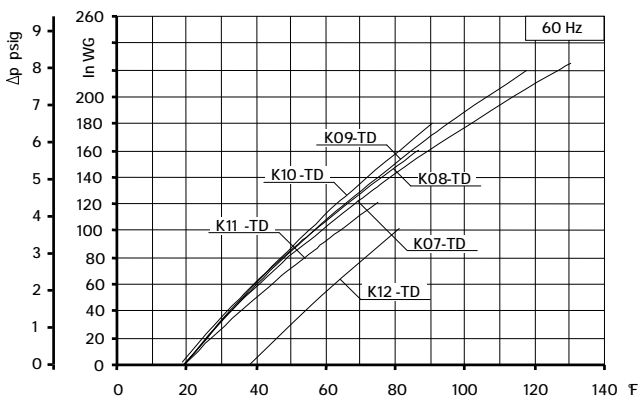
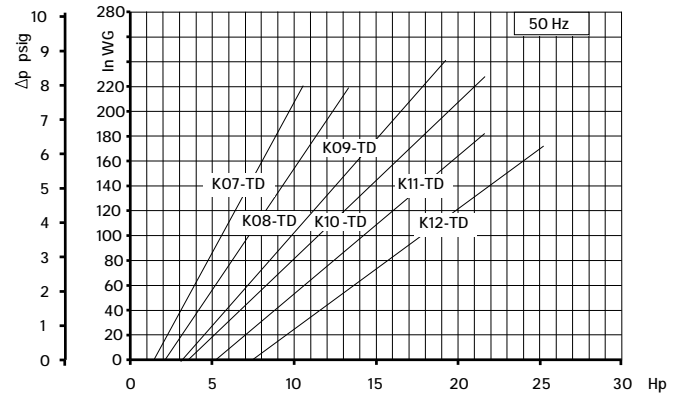
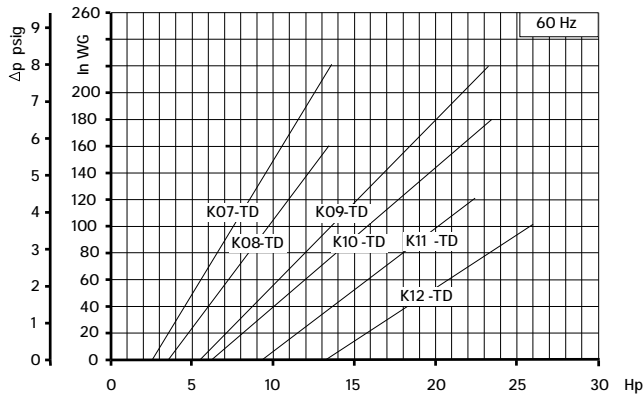
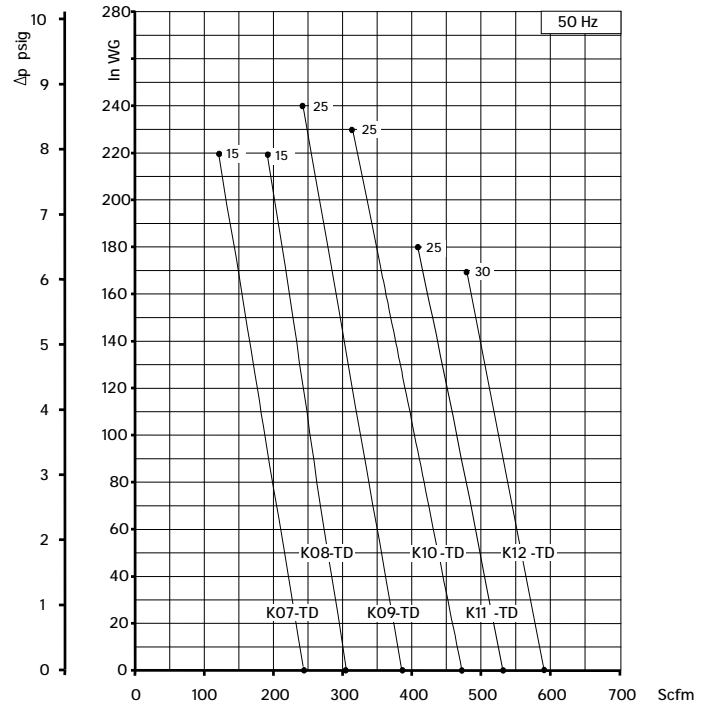
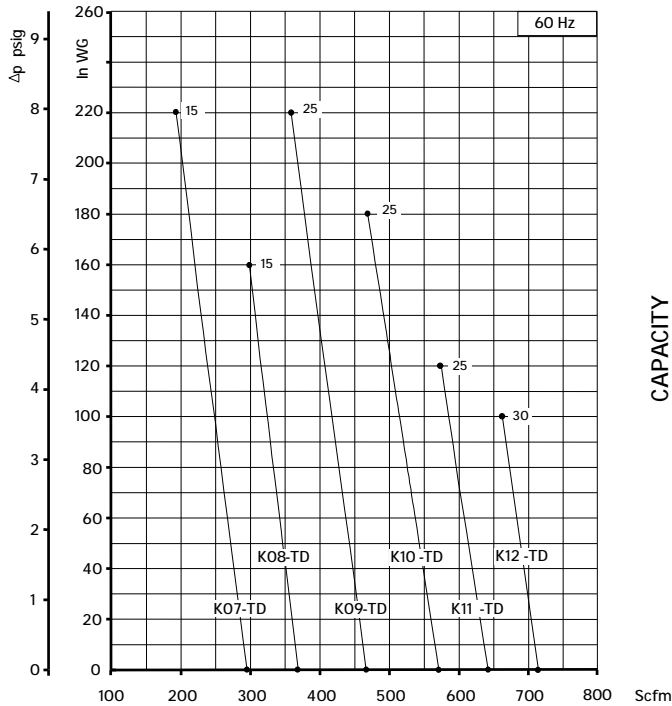

Curves refer to air at 68°F temperature and 29.92 In Hg atmospheric pressure (abs) measured at inlet port.
Values for flow, power consumption and temperature rise: +/-10% tolerance.
Data subject to change without notice.

STANDARD FEATURES

- Low weight cast aluminum construction.
- Quiet operation with integral inlet and outlet muffling.
- Recognized TEFC - cURus motor.
- High efficiency / low noise impeller design.
- No lubrication / maintenance required.
- Allowed ambient: +5 °F to +104 °F.
- Mountable in any plane.

OPTIONS

- Special voltages.
- Surface treatment or plating.
- Gas tight sealing.
- Special designs available.

ACCESSORIES

- Inlet and/or inline filters.
- Additional inlet/outlet silencers.
- Safety valves.
- Flow converting devices.
- Optionals connectors

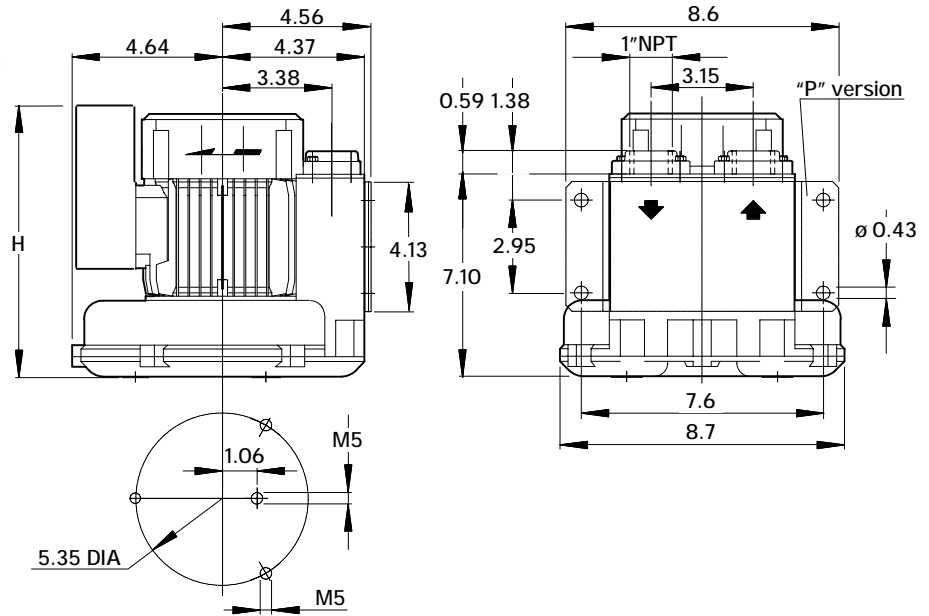

Dimensions in inches.
Dimension for reference only.

Model	Maximum flow Scfm		Installed power Hp		Maximum differential pressure Δp (In WG)		Noise level Lp dB (A) (1)		Overall dimensions H Inches	Weight Lbs
	60 Hz 3500 rpm	50 Hz 2900 rpm	60 Hz 3500 rpm	50 Hz 2900 rpm	60 Hz 3500 rpm	50 Hz 2900 rpm	60 Hz 3500 rpm	50 Hz 2900 rpm		
06	39	32	1/3	-	36	-	58.7	-	10.60	18.30
			1/2	1/2	52	36	59.0	58.0	10.60	18.50

(1) Noise measured at 1 m distance with inlet and outlet ports piped, in accordance to ISO 3744.

- For proper use, the blower should be equipped with inlet filter and safety valve; other accessories available on request.
- Ambient temperature from +5° to +104°F.
- Specifications subject to change without notice.

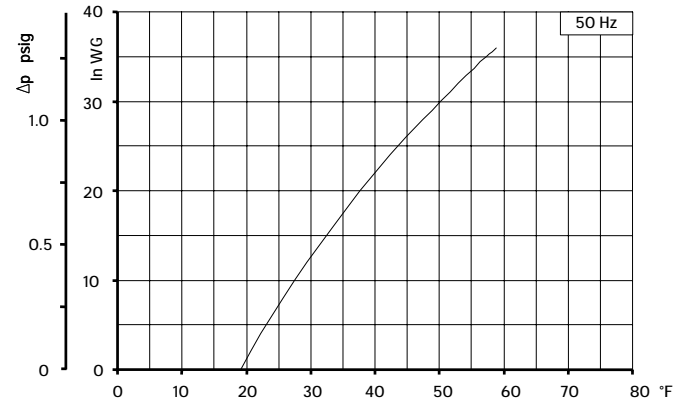
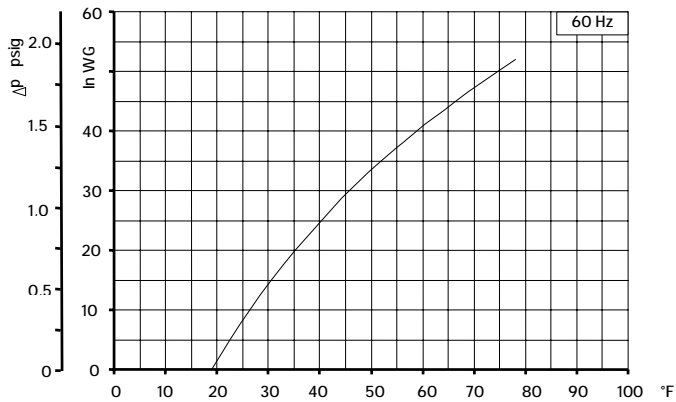
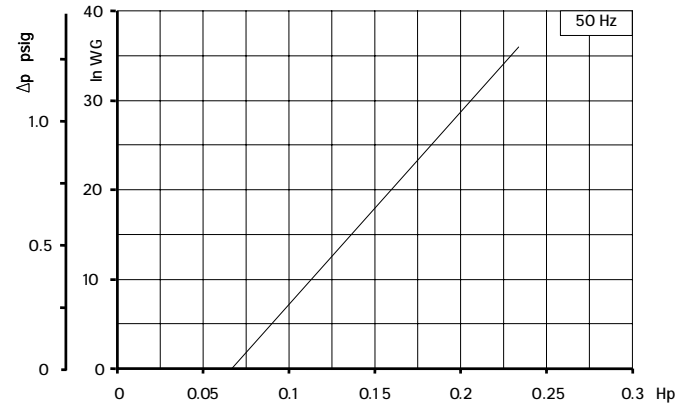
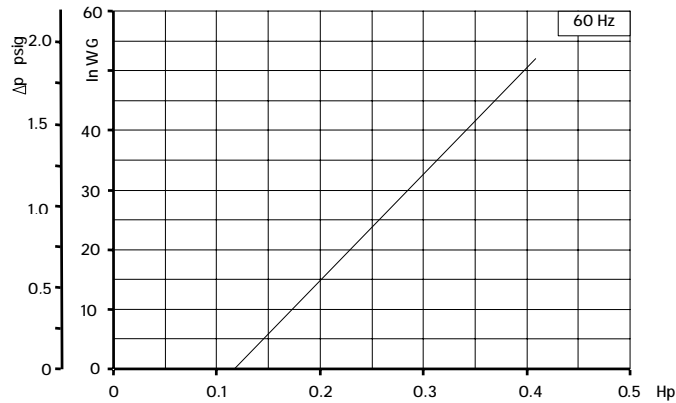
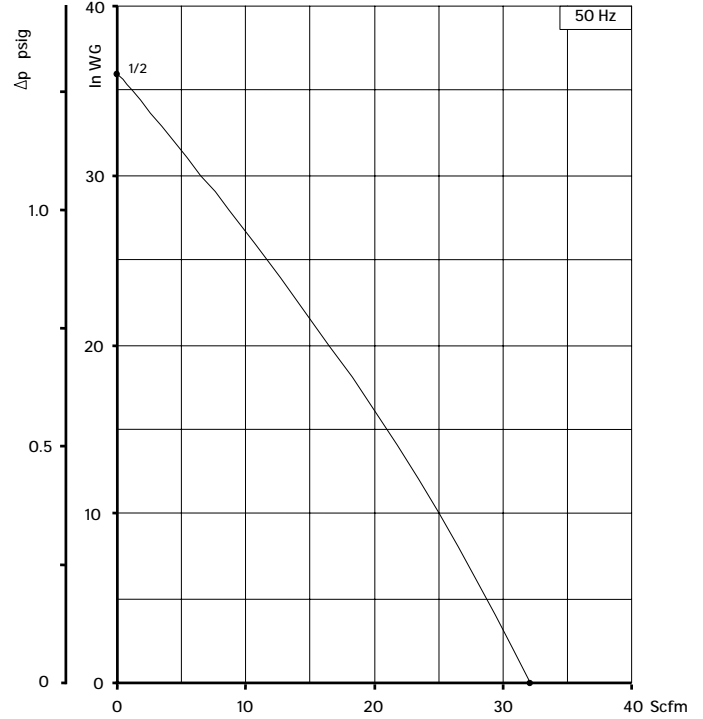
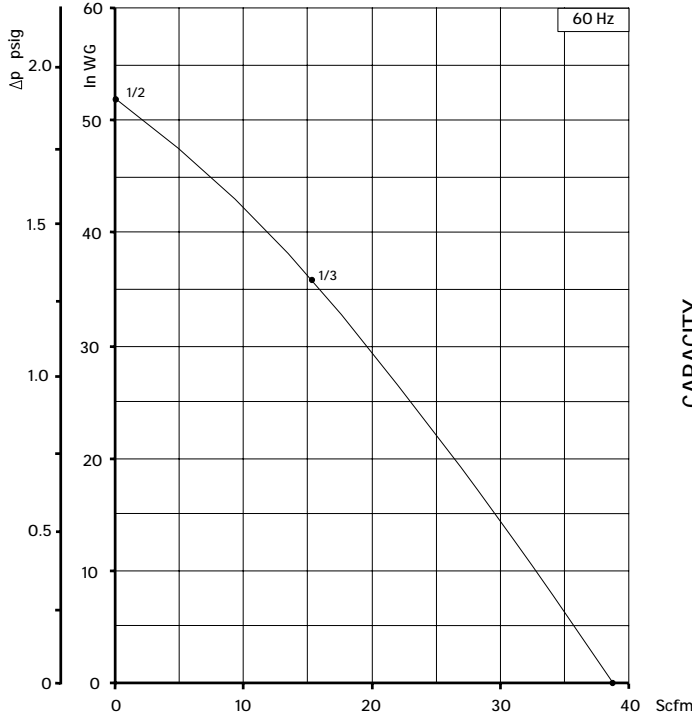

Curves refer to air at 68°F temperature and 29.92 In Hg atmospheric pressure (abs) measured at inlet port.
Values for flow, power consumption and temperature rise: +/-10% tolerance.
Data subject to change without notice.



SCL 10DL / 15DH

MD SERIES

SN 2197-5B 1/2

STANDARD FEATURES

- Low weight cast aluminum construction.
- Quiet operation with integral inlet and outlet muffling.
- Recognized TEFC - cURus motor.
- High efficiency / low noise impeller design.
- No lubrication / maintenance required.
- Allowed ambient: +5 °F to +104 °F.
- Mountable in any plane.

OPTIONS

- Remote drive models (belt or coupling).
- Special voltages.
- Surface treatment or plating.
- Gas tight sealing.
- Special designs available.

ACCESSORIES

- Inlet and/or inline filters.
- Additional inlet/outlet silencers.
- Safety valves.
- Flow converting devices.
- Optionals connectors

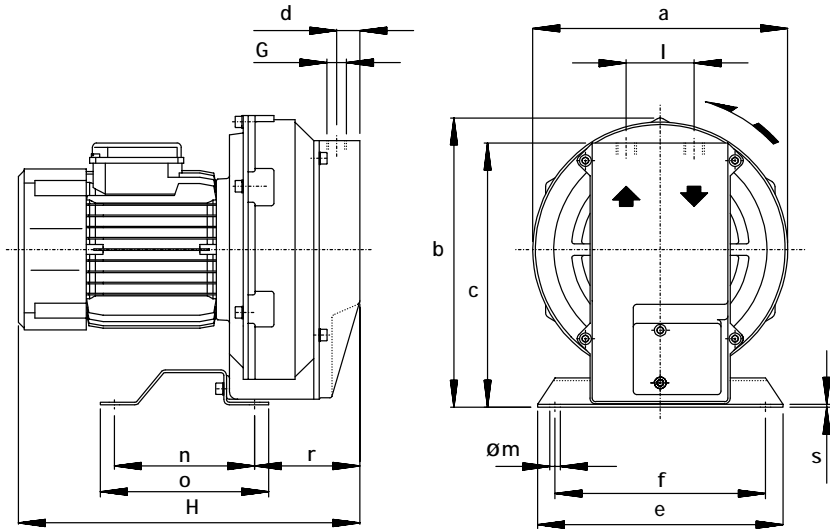

Dimensions in inches.
Dimension for reference only.

Model	a	b	c	d	e	f	G	l	m	n	o	r	s
10DL-MD	8.66	10.08	9.06	0.91	8.27	7.09	1/2" NPT	2.28	0.35	4.72	5.67	3.54	0.10
15DH-MD	9.84	11.26	10.16	1.18	8.27	7.09	3/4" NPT	2.52	0.35	4.72	5.67	4.72	0.10

Model	Maximum flow Scfm		Installed power Hp		Maximum differential pressure Δp (In WG)		Noise level Lp dB (A) ⁽¹⁾		Overall dimensions H Inches	Weight Lbs
	60 Hz 3500 rpm	50 Hz 2900 rpm	60 Hz 3500 rpm	50 Hz 2900 rpm	60 Hz 3500 rpm	50 Hz 2900 rpm	60 Hz 3500 rpm	50 Hz 2900 rpm		
10DL-MD	21	18	1/2	1/2	96	73	64.0	62.0	12.76	23.50
15DH-MD	35	29	3/4	3/4	98	105	63.7	61.7	14.25	32.50
			1	1	120.5	120.5	64.0	62.0	15.75	40.00

(1) Noise measured at 1 m distance with inlet and outlet ports piped, in accordance to ISO 3744.

- For proper use, the blower should be equipped with inlet filter and safety valve; other accessories available on request.
- Ambient temperature from +5° to +104°F.
- Specifications subject to change without notice.



SCL 10DL / 15DH
MD SERIES
SN 2197-5B 2/2

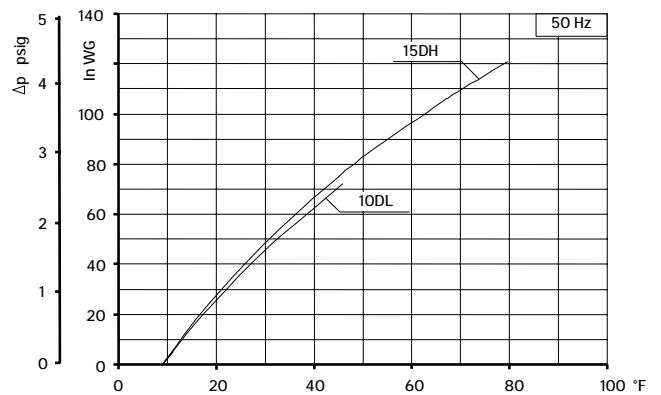
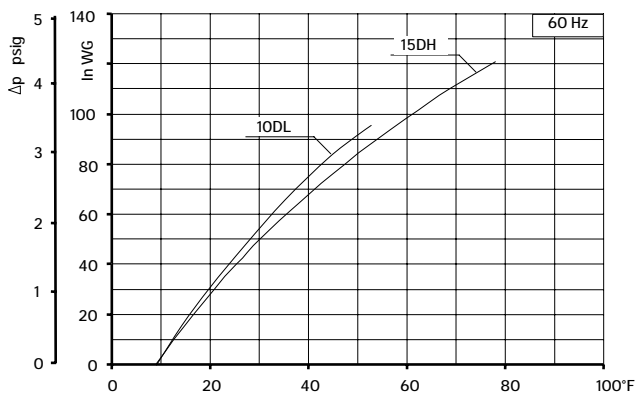
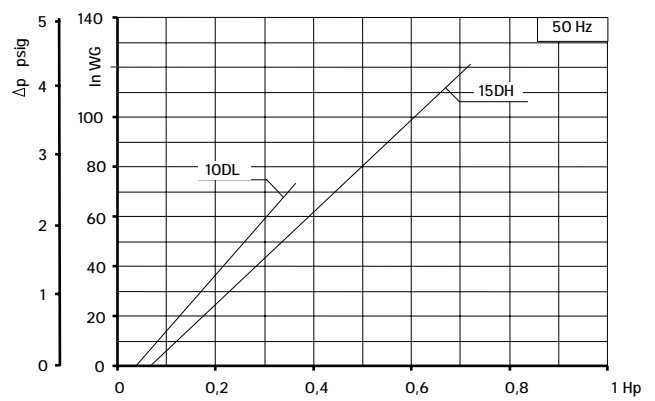
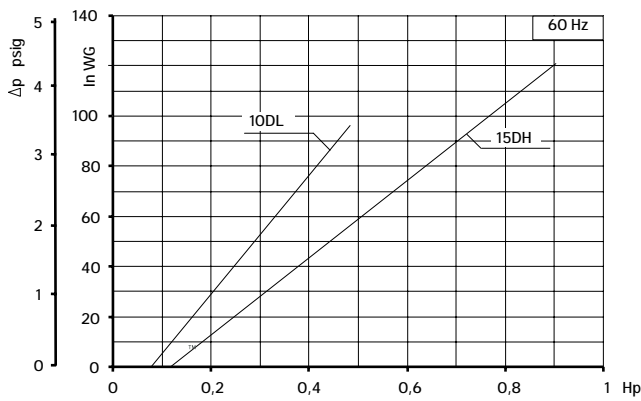
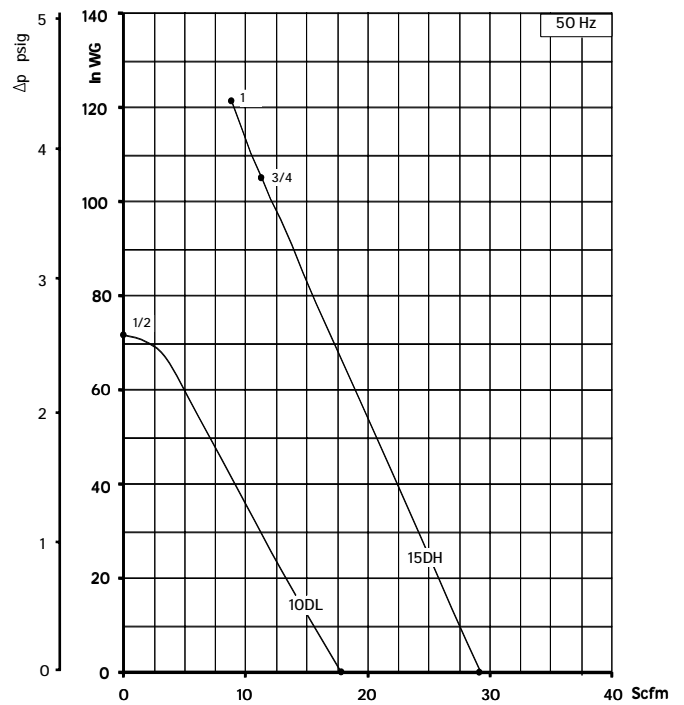
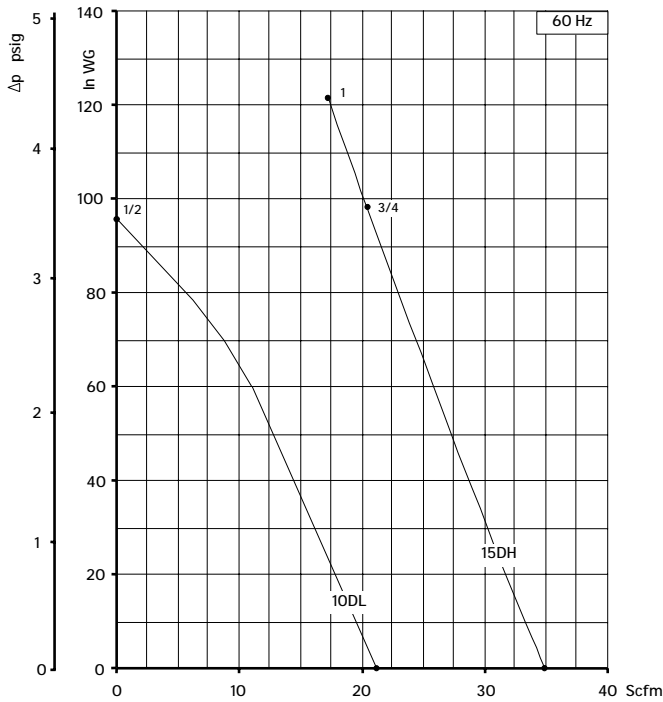

Curves refer to air at 68°F temperature and 29.92 In Hg atmospheric pressure (abs) measured at inlet port. Values for flow, power consumption and temperature rise: +/-10% tolerance. Data subject to change without notice.



STANDARD FEATURES

- Low weight cast aluminum construction.
- Quiet operation with integral inlet and outlet muffling.
- Recognized TEFC - cURus motor.
- High efficiency / low noise impeller design.
- No lubrication / maintenance required.
- Allowed ambient: +5 °F to +104 °F.
- Mountable in any plane.

OPTIONS

- Remote drive models (belt or coupling).
- Special voltages.
- Surface treatment or plating.
- Gas tight sealing.
- Special designs available.

ACCESSORIES

- Inlet and/or inline filters.
- Additional inlet/outlet silencers.
- Relief valves.
- Flow converting devices.
- Optionals connectors

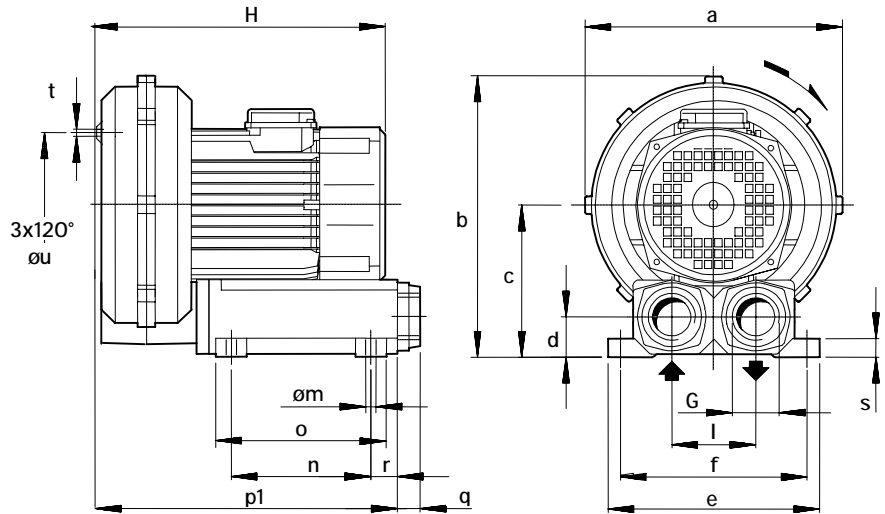

Dimensions in inches.
Dimension for reference only.

Model	a	b	c	d	e	f	G	I	m	n	o	p1	q	r	s	t	u
R20-MD	11.14	12.17	6.57	1.85	9.25	8.27	1" ¼ NPT	3.54	0.39	5.91	7.87	13.58	0.71	1.77	0.87	M6	5.91
R30-MD	12.56	13.62	7.36	1.85	9.25	8.27	1" ¼ NPT	3.54	0.39	5.91	7.87	13.94	0.71	1.77	0.87	M6	7.09
R40-MD	13.78	14.65	7.76	1.85	9.25	8.27	1" ¼ NPT	3.54	0.39	5.91	7.87	14.33	0.71	1.77	0.87	M8	8.86

Model	Maximum flow Scfm		Installed power Hp		Maximum differential pressure Δp (In WG)		Noise level Lp dB (A) ⁽¹⁾		Overall dimensions H	Weight
	60 Hz 3500 rpm	50 Hz 2900 rpm	60 Hz 3500 rpm	50 Hz 2900 rpm	60 Hz 3500 rpm	50 Hz 2900 rpm	60 Hz 3500 rpm	50 Hz 2900 rpm		
	Inches		Lbs							
R20-MD	41	35	1 ½	1 ½	161	161	68.5	66.5	13.39	48.5
R30-MD	65	54	2	2	140	170	72.2	69.2	15.58	57.3
			3	-	191	-	72.8	69.7	15.55	66.1
R40-MD	78	69	3	3	141	170	72.8	70.8	16.22	77.2
			4	4	201	201	73.3	71.3	17.09	88.2

(1) Noise measured at 1 m distance with inlet and outlet ports piped, in accordance to ISO 3744.

- For proper use, the blower should be equipped with inlet filter and relief valve; other accessories available on request.
- Ambient temperature from +5° to +104°F.
- Specifications subject to change without notice.



SCL R20 / R30 / R40
MD SERIES

SN 2464-7 2/2

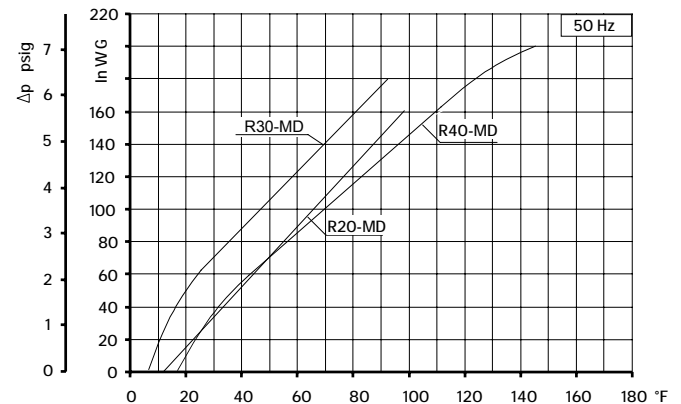
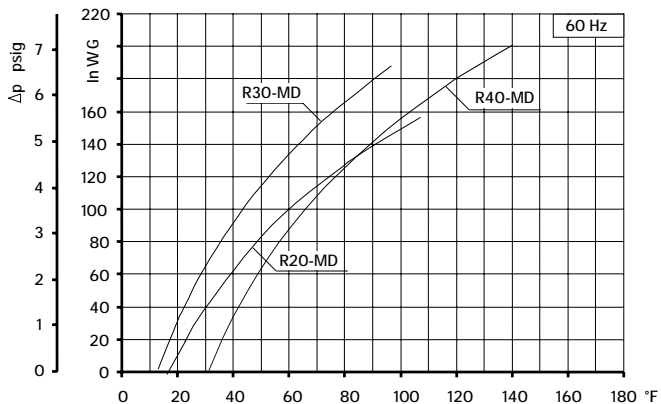
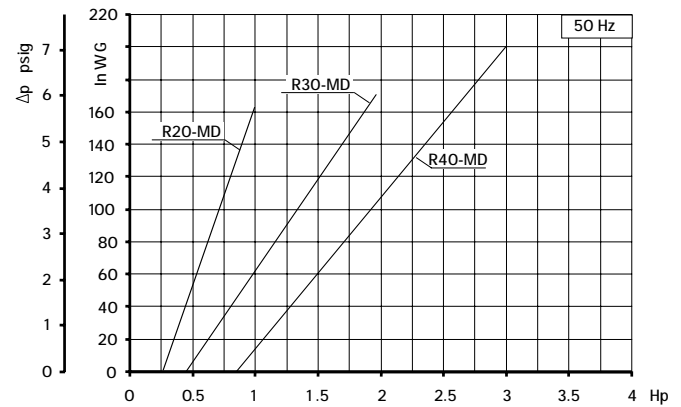
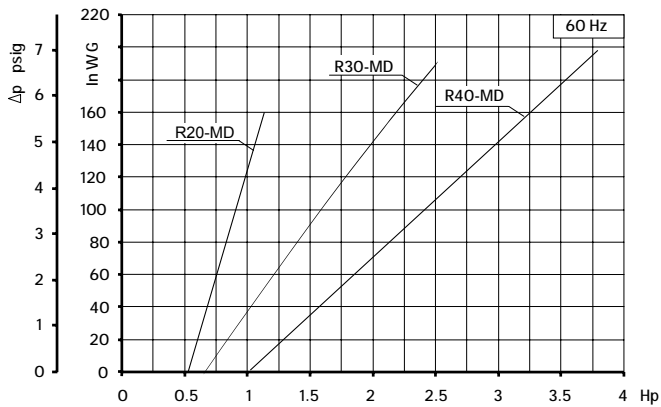
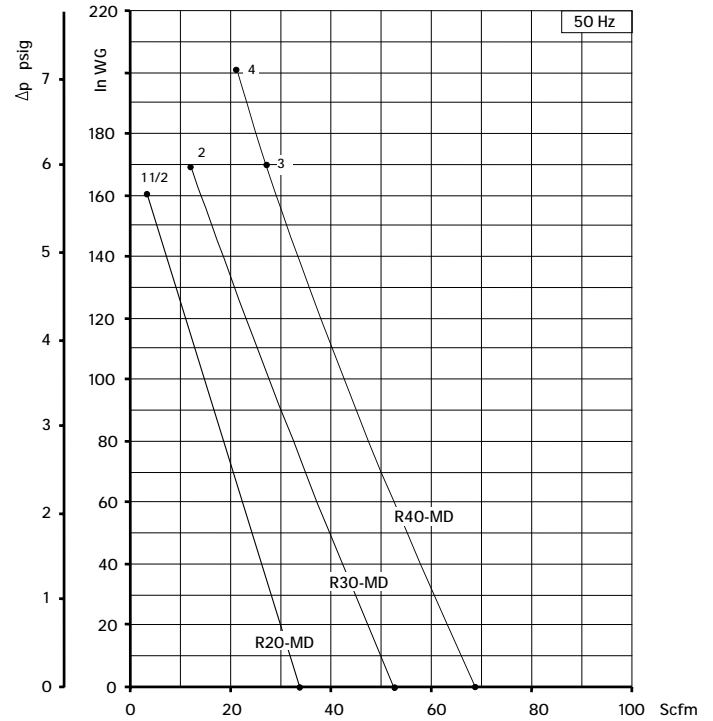
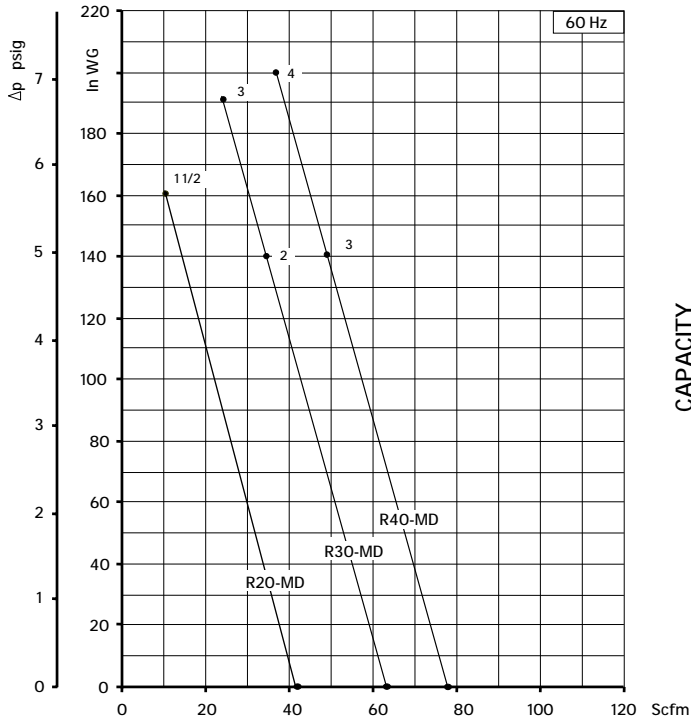

Curves refer to air at 68°F temperature and 29.92 In Hg atmospheric pressure (abs) measured at inlet port.
Values for flow, power consumption and temperature rise: +/-10% tolerance.
Data subject to change without notice.



SCL K03 / K04 / K05 / K06 MS SERIES - GOR/GVR RANGE

SN 2580-2 1/2

TECHNICAL CHARACTERISTICS

- Aluminium alloy construction
- Smooth operation
- High efficiency impeller
- Maintenance free
- Mountable in any position

OPTIONS

- Special voltages (IEC 38)
- Surface treatments

ACCESSORIES

- Inlet and/or inline filters
- Additional inlet/outlet silencers
- Safety valves
- Flow converting device
- Optional connectors

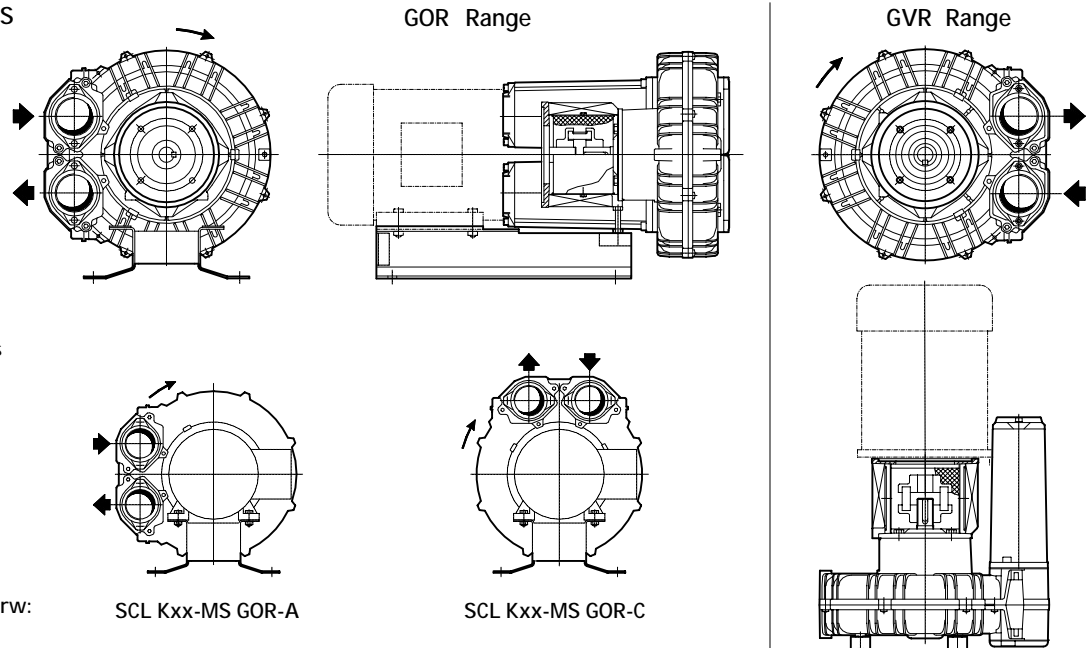

For dimensions, please refer to drw:

- GOR range: SI 1852

- GVR range: SI 1946

Model	Maximum flow Scfm		Installed power Hp	Size	Maximum differential pressure Δp (In WG)		Noise level Lp dB (A) (1)		Weight (2)	
	60 Hz 3500 rpm	50 Hz 2900 rpm			60 Hz 3500 rpm	50 Hz 2900 rpm	60 Hz 3500 rpm	50 Hz 2900 rpm	Lbs	
									GOR	GVR
K03-MS	52	43	3/4	NEMA 56C	64	60	62.0	60.0	22.00	17.60
			1	NEMA 56C	80		62.3			
K04-MS	98	81	1 1/2	NEMA 56C	58	80	64.8	62.8	27.60	22.00
			2	NEMA 56C	85	90	65.0	63.0		
			3	NEMA 56C	100		65.2			
K05-MS	156	129	2	NEMA 143-5TC	52	70	70.5	68.5	35.00	28.00
			3	NEMA 143-5TC	90	110	70.8	68.8	34.50	27.00
				NEMA 182-4TC						
K06-MS	216	179	3	NEMA 143-5TC	50	65	73.0	71.0	46.00	38.40
				NEMA 182-4TC					85	110
			7 1/2	NEMA 182-4TC	140	135	73.9	71.9		

(1) Noise measured at 1 m distance with inlet and outlet ports piped, in accordance to ISO 3744.

(2) Value is referred to weight of the machine without electric motor.

- For proper use, the blower should be equipped with inlet filter and safety valve; other accessories available on request.
- Ambient temperature from +5° to +104°F.
- Specifications subject to change without notice.



SCL K03 / K04 / K05 / K06
MS SERIES - GOR/GVR RANGE
SN 2580-2 2/2

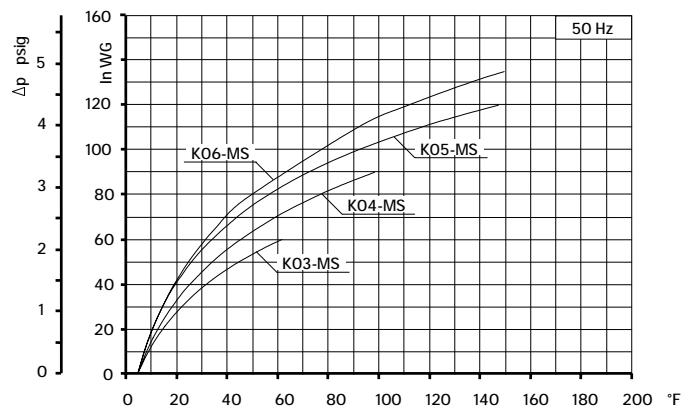
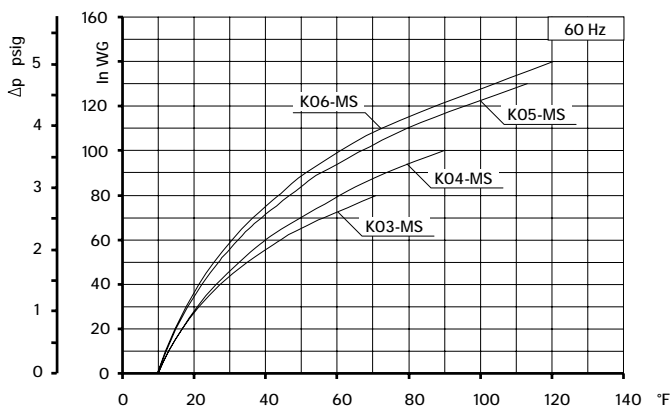
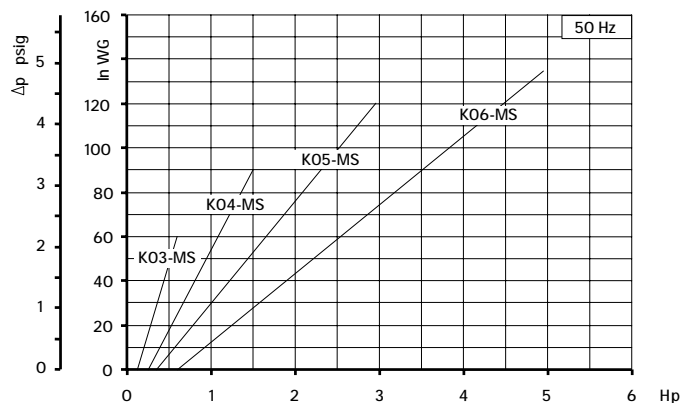
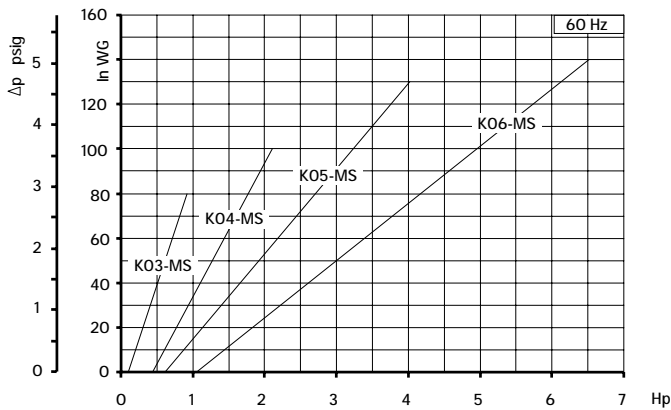
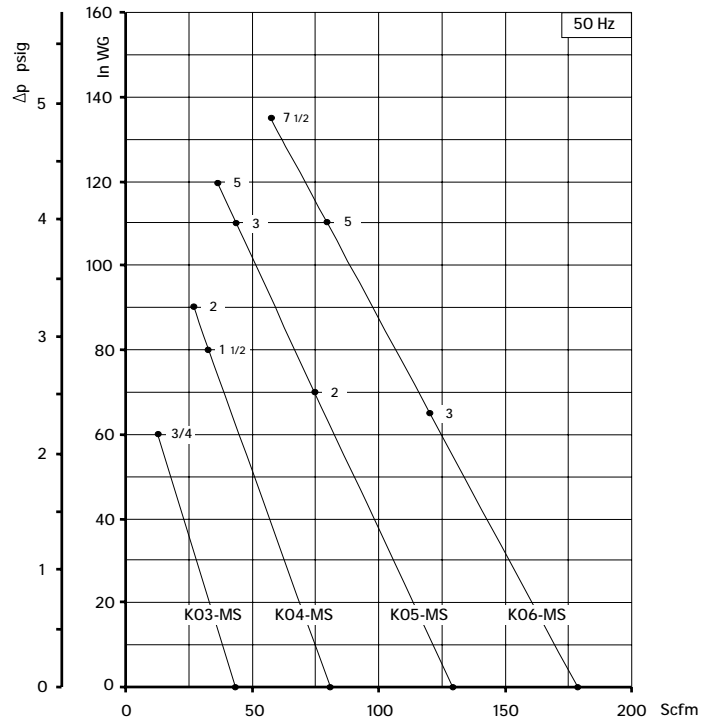
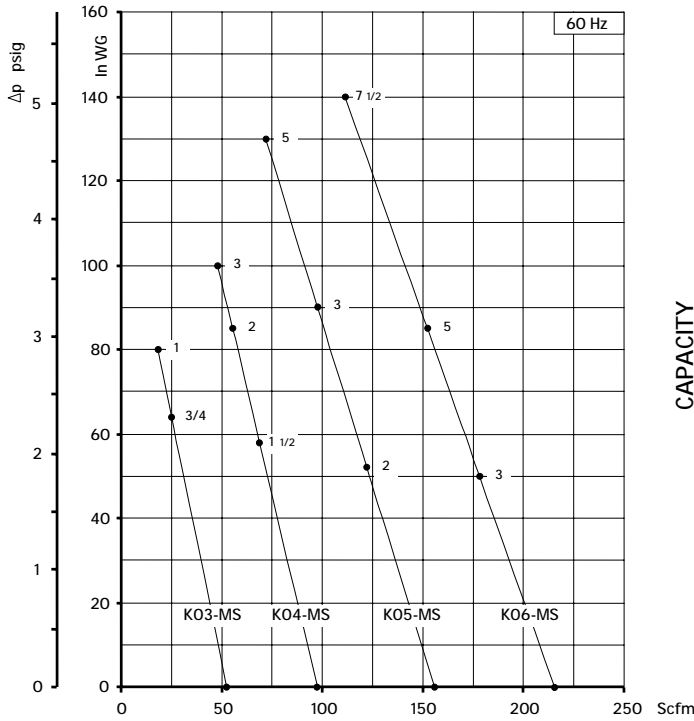

Curves refer to air at 68°F temperature and 29.92 In Hg atmospheric pressure (abs) measured at inlet port.
Values for flow, power consumption and temperature rise: +/-10% tolerance.
Data subject to change without notice.



SCL K07 / K08 / K09 / K10 / K11 / K12

MS SERIES - GOR/GVR RANGE

SN 2134-4 1/2

TECHNICAL

CHARACTERISTICS

- Aluminium alloy construction
- Smooth operation
- High efficiency impeller
- Maintenance free
- Mountable in any position

OPTIONS

- Special voltages (IEC 38)
- Surface treatments

ACCESSORIES

- Inlet and/or inline filters
- Additional inlet/outlet silencers
- Safety valves
- Flow converting device
- Optional connectors

For dimensions, please refer to drw:

GOR range: SI 1873

GVR range: SI 1920

GOR Range

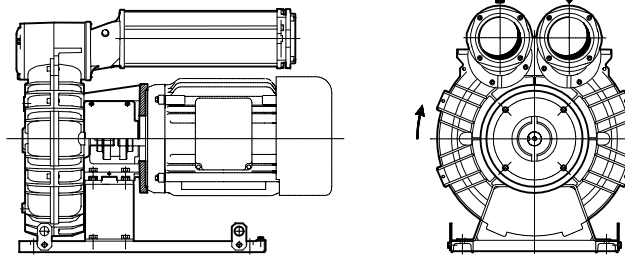

SCL Kxx-MS GOR-C

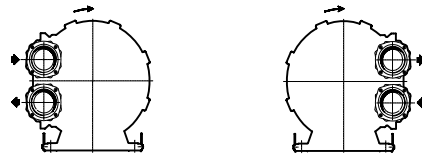

SCL Kxx-MS GOR-A

SCL Kxx-MS GOR-B

GVR Range

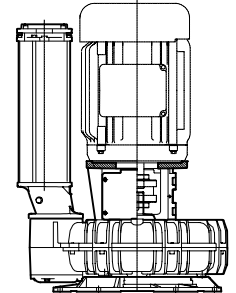
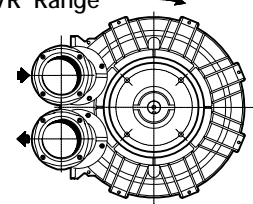

Model	Maximum flow Scfm		Installed power Hp	Size	Maximum differential pressure Δp (in WG)		Noise level Lp dB (A) ⁽¹⁾		Weight ⁽²⁾ Lbs
	60 Hz 3500 rpm	50 Hz 2900 rpm			60 Hz 3500 rpm	50 Hz 2900 rpm	60 Hz 3500 rpm	50 Hz 2900 rpm	
K07-MS	294	243	5	NEMA 182-4TC	70	86	79.0	77.0	110.5
			7 1/2	NEMA 182-4TC	130	140	79.3	77.3	110.5
				NEMA 213-5TC					110.5
			10	NEMA 213-5TC	170	79.6	110.5		
K08-MS	381	316	5	NEMA 182-4TC	38	52	79.7	77.7	127.0
			7 1/2	NEMA 182-4TC	68	90	80.0	78.0	127.0
				NEMA 213-5TC					127.0
			10	NEMA 213-5TC	115	125	80.3	78.3	127.0
			15	NEMA 213-5TC	170	160	80.6	78.6	127.0
NEMA 254-6TC	130.6								
K09-MS	471	390	7 1/2	NEMA 182-4TC	50	63	80.2	78.2	133.4
				NEMA 213-5TC					133.4
			10	NEMA 213-5TC	80	95	80.5	78.5	133.4
				NEMA 254-6TC					137.0
20	NEMA 254-6TC	180	170	81.3	79.3	137.0			
K10-MS	556	460	7 1/2	NEMA 182-4TC	30	50	80.1	78.1	147.3
				NEMA 213-5TC					147.3
			10	NEMA 213-5TC	60	80	80.5	78.5	147.3
				NEMA 213-5TC					147.3
			15	NEMA 213-5TC	110	135	81.0	79.0	151.0
				NEMA 254-6TC					151.0
20	NEMA 254-6TC	160	190	81.4	79.4	151.0			
	NEMA 284-6TSC			81.6		147.3			
K11-MS	650	539	10	NEMA 213-5TC	40	53	82.0	80.0	170.0
			15	NEMA 213-5TC	80	97	82.4	80.4	170.0
				NEMA 254-6TC					176.4
			20	NEMA 254-6TC	125	140	82.7	80.7	176.4
			25	NEMA 284-6TSC	160	190	85.6	83.6	170.0
NEMA 284-6TSC	200	86.0		170.0					
K12MS	726	602	15	NEMA 213-5TC	52	90	82.9	80.9	177.7
				NEMA 254-6TC					184.1
			20	NEMA 254-6TC	85	130	83.2	81.2	184.1
			25	NEMA 284-6TSC	120	170	86.1	84.1	177.7
				NEMA 284-6TSC			150		86.5
40	NEMA 324-6TSC	180	86.9	193.2					

(1) Noise measured at 1 m distance with inlet and outlet ports piped, in accordance to ISO 3744.

(2) Value is referred to weight of the machine without electric motor

- Specifications subject to change without notice.

- For proper use, the blower should be equipped with inlet filter and safety valve; other accessories available on request.

- Ambient temperature from +5° to +104°F.



SCL K07 / K08 / K09 / K10 / K11 / K12
MS SERIES - GOR/GVR RANGE
SN 2134-4 2/2

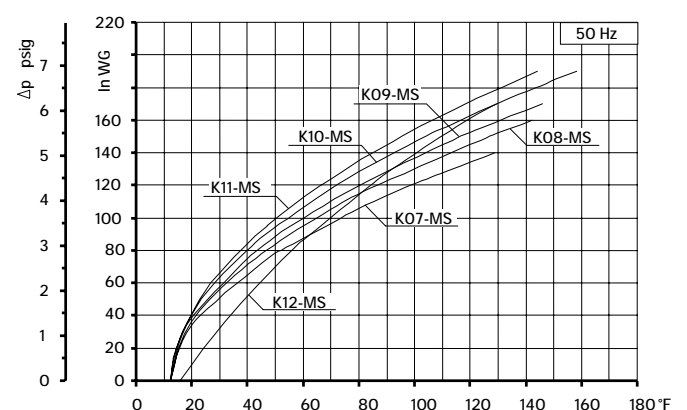
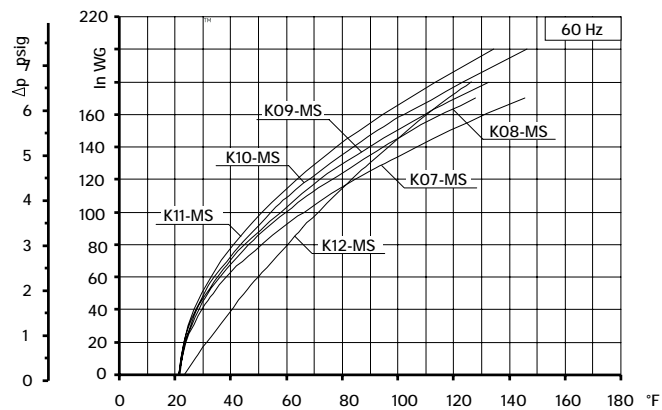
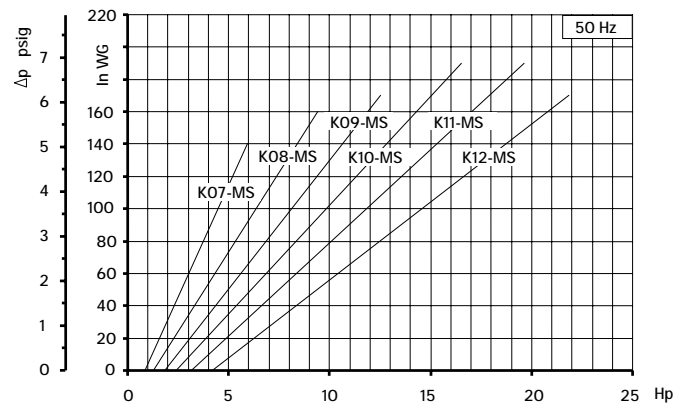
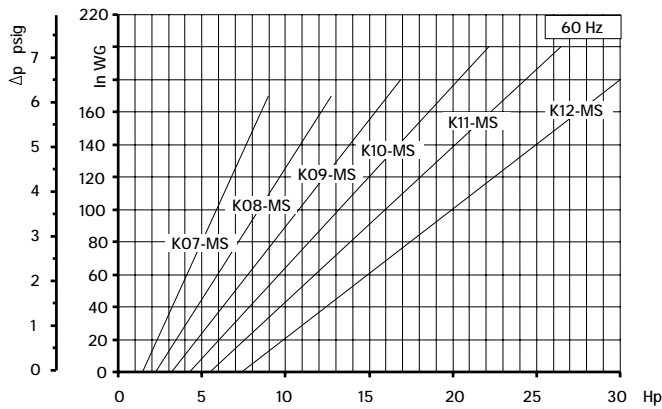
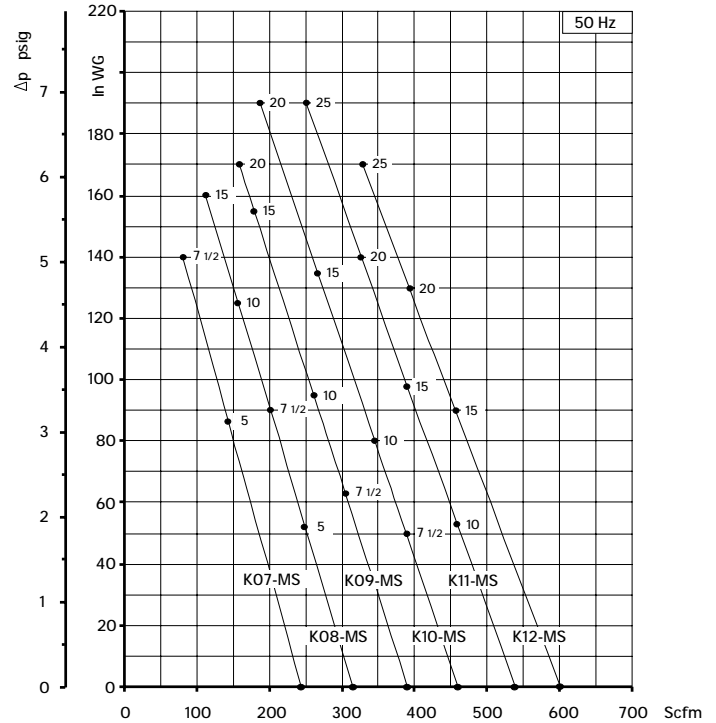
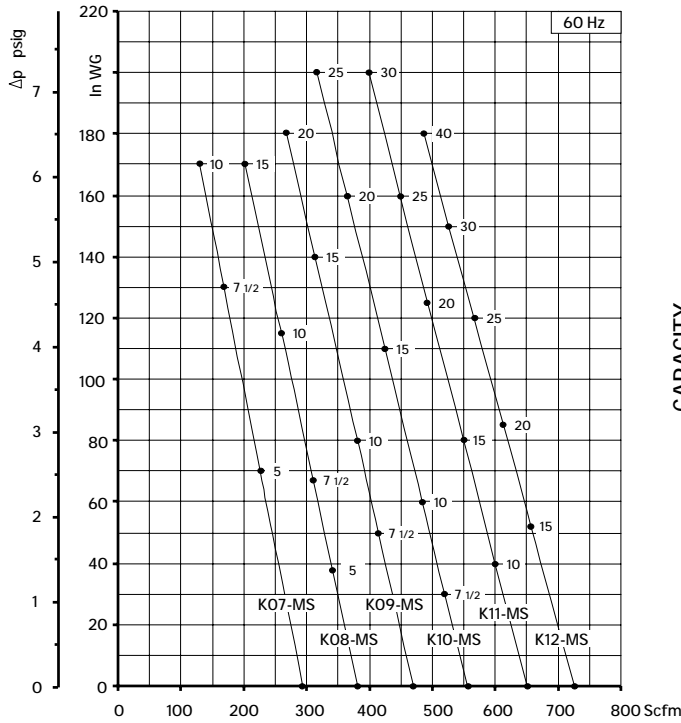

Curves refer to air at 68°F temperature and 29.92 In Hg atmospheric pressure (abs) measured at inlet port.
Values for flow, power consumption and temperature rise: +/-10% tolerance.
Data subject to change without notice.

TECHNICAL CHARACTERISTICS

- Aluminium alloy construction
- Smooth operation
- High efficiency impeller
- Maintenance free
- Mountable in any plane
- G1/8" female thread on both suction and discharge silencer port flanges.

OPTIONS

- Special voltages (IEC 38)
- Surface treatments

ACCESSORIES

- Inlet and/or inline filters
- Additional inlet/outlet silencers
- Safety valves
- Flow converting device
- Optional connectors

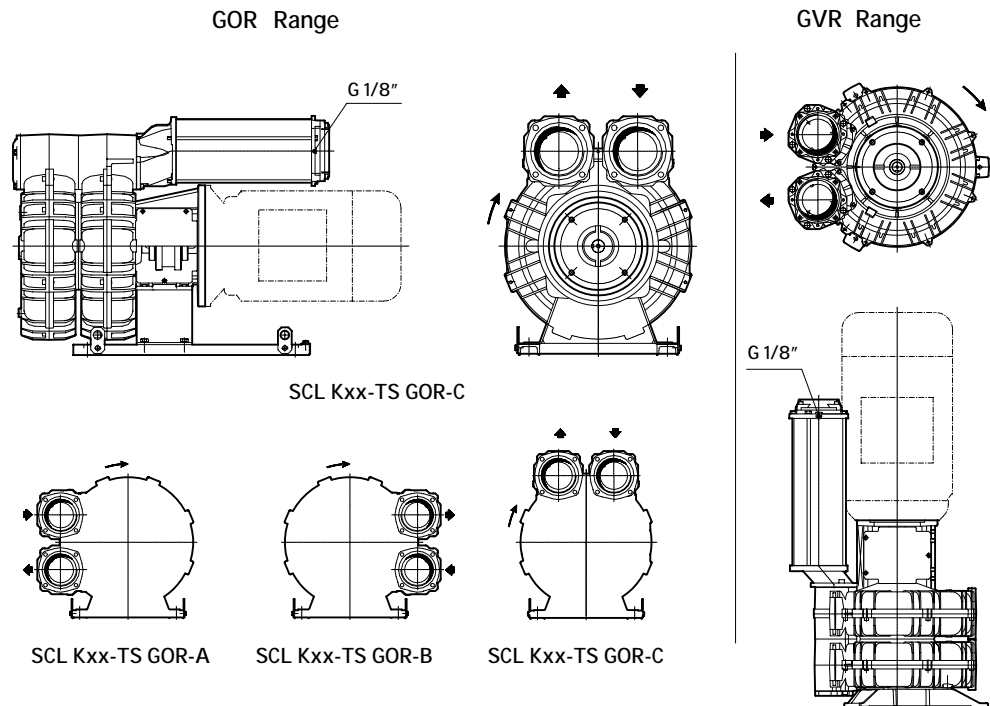

For dimensions, please refer to drw:

- GOR range: SI 21 23
- GVR range: SI 21 35

Model	Maximum flow m ³ /h		Installed power Hp	Size	Maximum differential pressure Δp (in WG)		Noise level Lp dB (A) (1)		Weight (2)	
	60 Hz 3500 rpm	50 Hz 2900 rpm			60 Hz 3500 rpm	50 Hz 2900 rpm	60 Hz 3500 rpm	50 Hz 2900 rpm	Lbs	
							GOR	GVR		
K05-TS	290	241	5.0	NEMA 182-4TC	60	85	75.5	73.5	72.75	68.35
			7.5		100	110	77.5	75.5		
K06-TS	400	331	7.5	NEMA 213-5TC	55	77	77.5	75.5	112.45	108.00
			10		80	110	77.8	75.8		
			15		130	120	78.4	76.4		

(1) Noise measured at 1 m distance with inlet and outlet ports piped, in accordance to ISO 3744.

(2) Value is referred to weight of the machine without electric motor.

- For proper use, the blower should be equipped with inlet filter and safety valve; other accessories available on request.
- Ambient temperature from +5° to +104°F.
- Specifications subject to change without notice.



SCL K05 / K06
TS SERIES - GOR/GVR RANGE

SN 2686-2 2/2

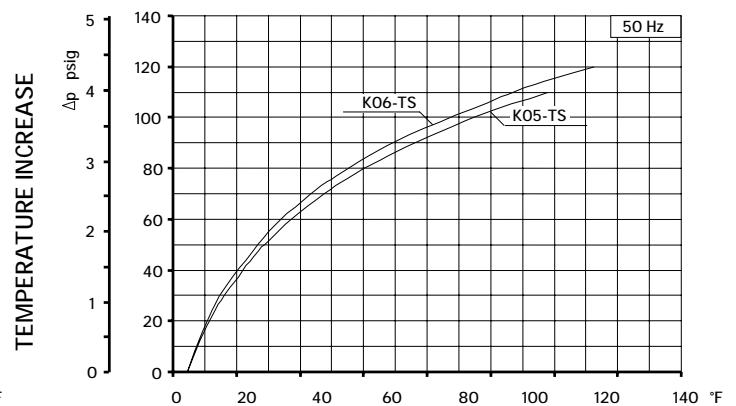
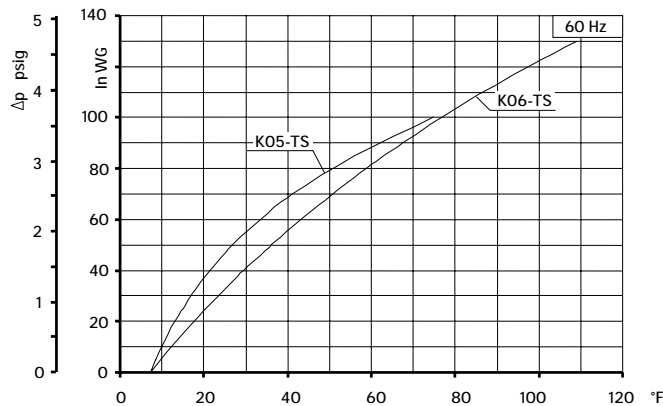
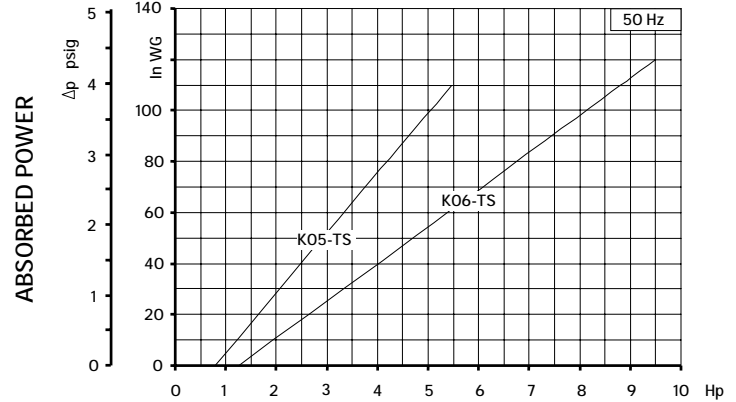
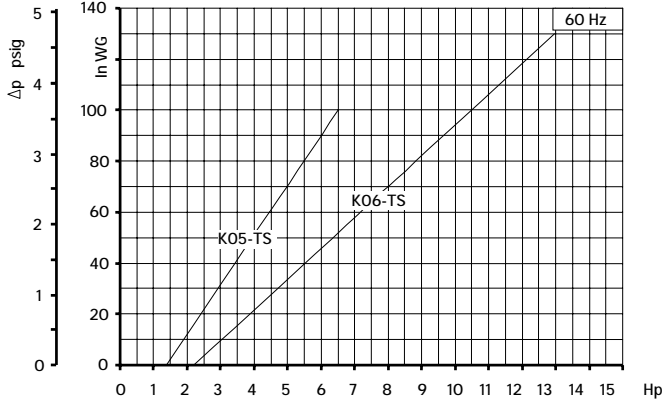
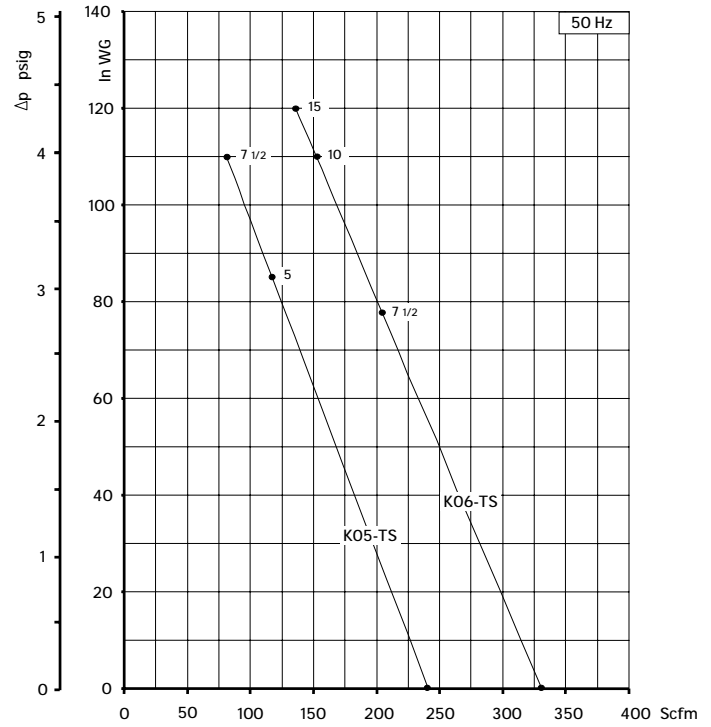
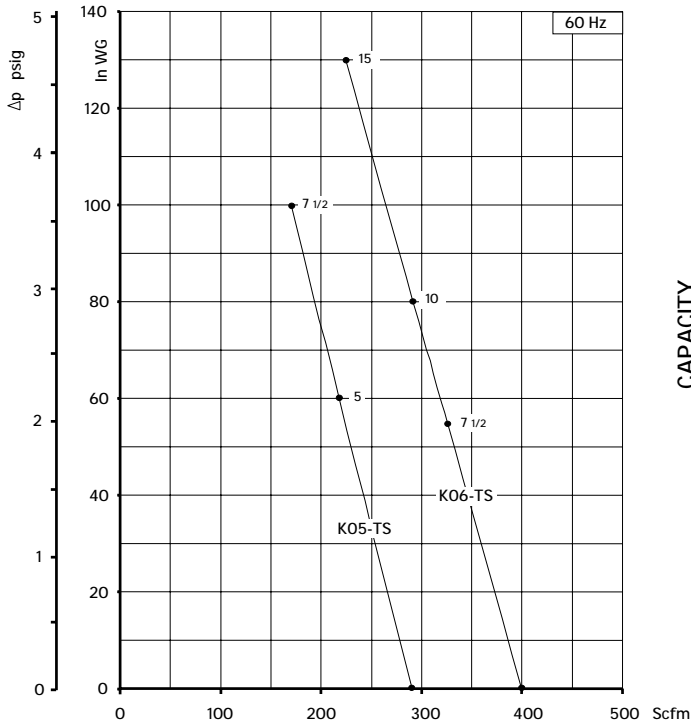

Curves refer to air at 68°F temperature and 29.92 In Hg atmospheric pressure (abs) measured at inlet port.
Values for flow, power consumption and temperature rise: +/-10% tolerance.
Data subject to change without notice.



SCL K07 / K08 / K09 / K10 / K11 / K12

TS SERIES - GOR/GVR RANGE

SN 2164-6 1/2

TECHNICAL CHARACTERISTICS

- Aluminium alloy construction
- Smooth operation
- High efficiency impeller
- Maintenance free
- Mountable in any position
- G1/8" female thread on both suction and discharge silencer port flanges

OPTIONS

- Special voltages (IEC 38)
- Surface treatments

ACCESSORIES

- Inlet and/or inline filters
- Additional inlet/outlet silencers
- Safety valves
- Flow converting device
- Optional connectors

For dimensions, please refer to drw:

GOR range: SI 1879

GVR range: SI 1880

GOR RANGE

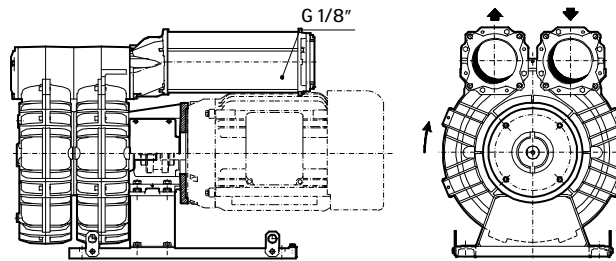

SCL Kxx-TS GOR-C

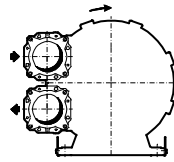

SCL Kxx-TS GOR-A

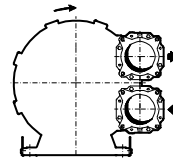

SCL Kxx-TS GOR-B

GVR RANGE

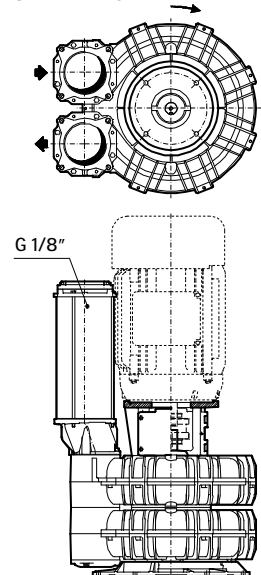

Model	Maximum flow Scfm		Installed power Hp	Size	Maximum differential pressure Δp (In WG)		Noise level Lp dB (A) (1)		Weight (2) Lbs	
	60 Hz 3500 rpm	50 Hz 2900 rpm			60 Hz 3500 rpm	50 Hz 2900 rpm	60 Hz 3500 rpm	50 Hz 2900 rpm		
K07-TS	588	487	7 1/2	NEMA 182-4TC	36	60	83.9	81.9	160.90	
				NEMA 213-5TC	36	60	83.9	81.9	160.90	
			10	NEMA 213-5TC	60	90	84.2	82.2	160.90	
				NEMA 213-5TC	110	140	84.8	82.8	160.90	
				NEMA 254-6TC	110	140	84.8	82.8	167.60	
K08-TS	715	592	10	NEMA 254-6TC	140	140	85.3	82.8	167.60	
				NEMA 213-5TC	37	64	80.9	78.9	172.00	
			15	NEMA 213-5TC	75	105	83.3	81.3	172.00	
				NEMA 254-6TC	75	105	83.3	81.3	180.80	
K09-TS	941	780	20	NEMA 254-6TC	100	150	84.6	82.6	180.80	
				NEMA 284-6TSC	140	150	86.0	82.6	174.20	
			25	NEMA 213-5TC	52	75	83.0	81.0	202.80	
				NEMA 254-6TC	52	75	83.0	81.0	208.30	
				NEMA 284-6TSC	80	108	85.0	83.0	208.30	
K10-TS	1093	906	30	NEMA 284-6TSC	110	145	87.0	85.0	205.00	
				NEMA 284-6TSC	120	160	89.0	87.0	205.00	
			40	NEMA 324-6TSC	150	160	91.0	87.0	220.50	
				15	NEMA 213-5TC	41	64	87.8	85.8	209.40
					NEMA 254-6TC	41	64	87.8	85.8	216.10
K11-TS	1254	1039	20	NEMA 254-6TC	65	90	88.1	86.1	216.10	
				NEMA 284-6TSC	80	110	88.4	86.4	211.60	
			30	NEMA 284-6TSC	100	140	88.7	86.7	211.60	
				NEMA 284-6TSC	100	140	88.7	86.7	211.60	
				NEMA 324-6TSC	150	160	89.0	87.0	227.10	
K12-TS	1410	1168	40	NEMA 284-6TSC	50	88	89.4	87.4	251.30	
				NEMA 284-6TSC	70	110	90.0	88.0	251.30	
			50	NEMA 324-6TSC	110	160	90.6	88.6	269.00	
				NEMA 324-6TSC	140	155	91.2	88.6	269.00	
K12-TS	1410	1168	30	NEMA 284-6TSC	45	80	90.6	88.6	249.10	
				NEMA 324-6TSC	70	120	91.2	89.2	266.80	
			50	NEMA 324-6TSC	110	150	91.8	89.8	266.80	

(1) Noise measured at 1 m distance with inlet and outlet ports piped, in accordance to ISO 3744.

(2) Value is referred to weight of the machine without electric motor

- Ambient temperature from +5° to +104F.

- Specifications subject to change without notice.

- For proper use, the blower should be equipped with inlet filter and safety valve; other accessories available on request.



SCL K07 / K08 / K09 / K10 / K11 / K12 TS SERIES - GOR/GVR RANGE

SN 2164-6 2/2

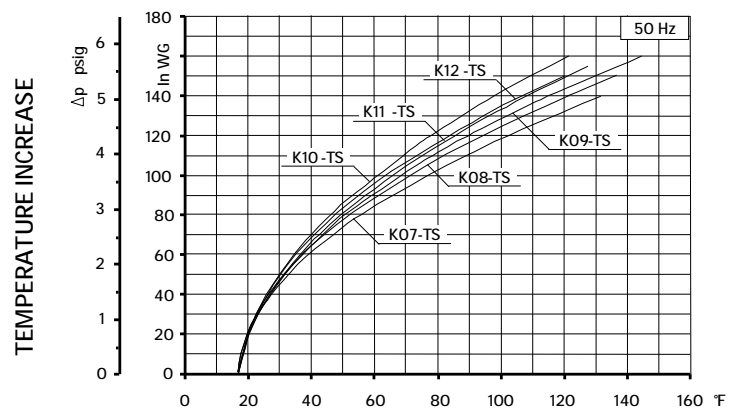
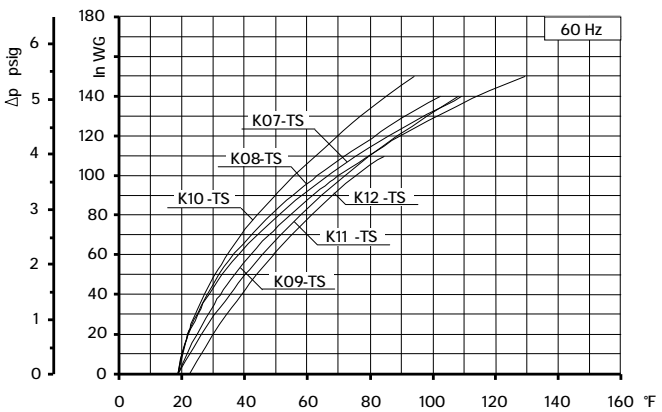
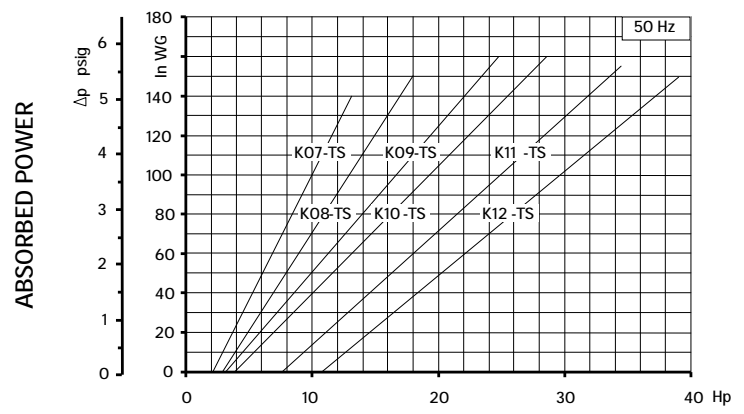
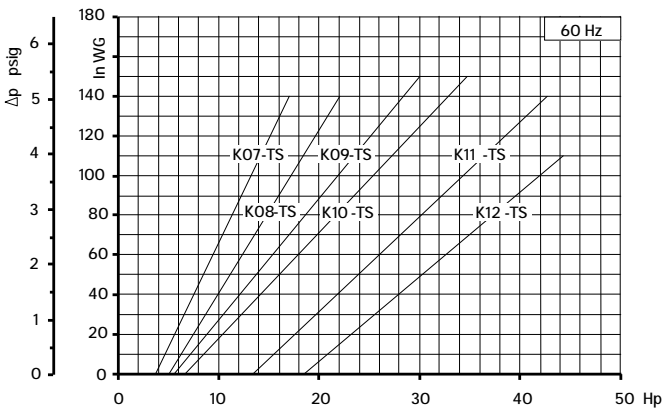
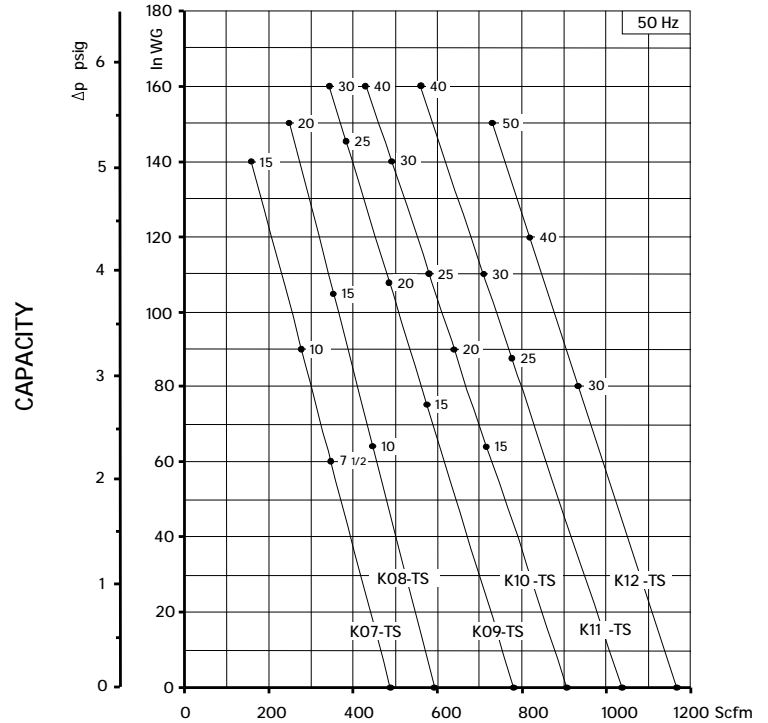
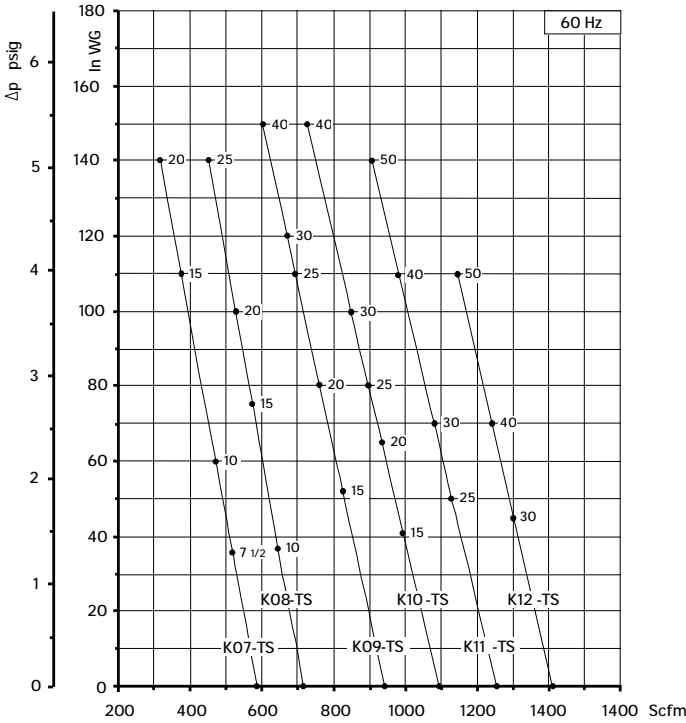

Curves refer to air at 68F temperature and 29.92 In Hg atmospheric pressure (abs) measured at inlet port.
Values for flow, power consumption and temperature rise: +/-10% tolerance.
Data subject to change without notice.



SCL K07R / K08R / K09 / K10 / K11 / K12

MD SERIES - GOR/GVR RANGE

SN 2149-3 1/2

TECHNICAL CHARACTERISTICS

- Aluminium alloy construction
- Smooth operation
- High efficiency impeller
- Maintenance free
- Mountable in any position

OPTIONS

- Special voltages (IEC 38)
- Surface treatments

ACCESSORIES

- Inlet and/or inline filters
- Additional inlet/outlet silencers
- Safety valves
- Flow converting device
- Optional connectors

GOR Range

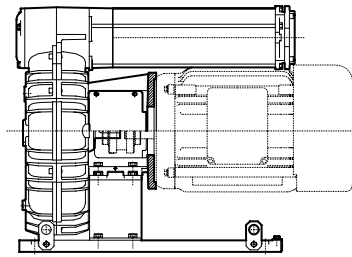

SCL Kxx-MD GOR-C

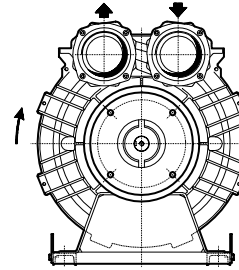

SCL Kxx-MD GOR-B

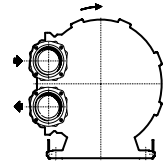

SCL Kxx-MD GOR-A

GVR Range

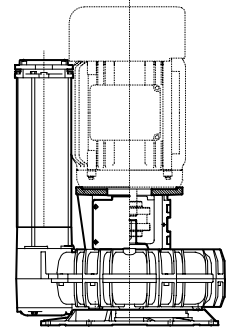
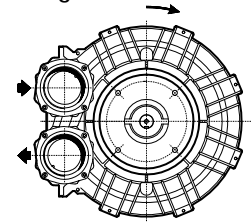

For dimensions, please refer to drw:

GOR range: SI 1918

GVR range: SI 1919

Model	Maximum flow Scfm		Installed power Hp	Size	Maximum differential pressure Δp (In WG)		Noise level Lp dB (A) (1)		Weight (2) Lbs
	60 Hz 3500 rpm	50 Hz 2900 rpm			60 Hz 3500 rpm	50 Hz 2900 rpm	60 Hz 3500 rpm	50 Hz 2900 rpm	
K07R-MD	129	107	3	NEMA 56C	68	87	73.5	71.5	112.00
				NEMA 143-5TC					112.00
			5	NEMA 182-4TC	145	170	74.5	72.5	113.80
			7 1/2	NEMA 182-4TC NEMA 213-5TC	250	260	75.0	73.0	113.80 113.80
K08R-MD	168	139	5	NEMA 182-4TC	80	110	76.2	74.2	130.30
			7 1/2	NEMA 182-4TC NEMA 213-5TC	160	185	76.6	74.6	130.30 130.30
			10	NEMA 213-5TC	220	250	77.0	75.0	130.30
			15	NEMA 213-5TC	260	-	77.4	-	130.30
K09-MD	221	183	5	NEMA 182-4TC	50	78	76.9	74.9	138.50
			7 1/2	NEMA 182-4TC NEMA 213-5TC	120	143	78.0	76.0	138.50 138.50
			10	NEMA 213-5TC	190	210	79.5	77.5	138.50
			15	NEMA 213-5TC	280	280	80.5	78.5	138.50
K10-MD	275	228	7 1/2	NEMA 182-4TC NEMA 213-5TC	85	110	79.9	77.9	125.40 152.40
			10	NEMA 213-5TC	140	165	80.3	78.3	152.40
			15	NEMA 213-5TC	245	280	81.4	79.4	152.40
K11-MD	306	254	10	NEMA 213-5TC	100	125	81.1	79.1	175.70
			15	NEMA 213-5TC NEMA 254-6TC	190	220	81.4	79.4	175.70 182.10
			20	NEMA 254-6TC	270	280	81.7	79.7	182.10
K12-MD	336	278	15	NEMA 213-5TC NEMA 254-6TC	100	180	82.3	80.3	183.40 189.80
			20	NEMA 254-6TC	180	260	82.6	80.6	189.80
			25	NEMA 284-6TSC	250	-	82.9	-	183.40

(1) Noise measured at 1 m distance with inlet and outlet ports piped, in accordance to ISO 3744.

(2) Value is referred to weight of the machine without electric motor

- For proper use, the blower should be equipped with inlet filter and safety valve; other accessories available on request.
- Ambient temperature from +5° to +104°F.
- Specifications subject to change without notice.



SCL K07R / K08R / K09 / K10 / K11 / K12 MD SERIES - GOR/GVR RANGE

SN 2149-3 2/2

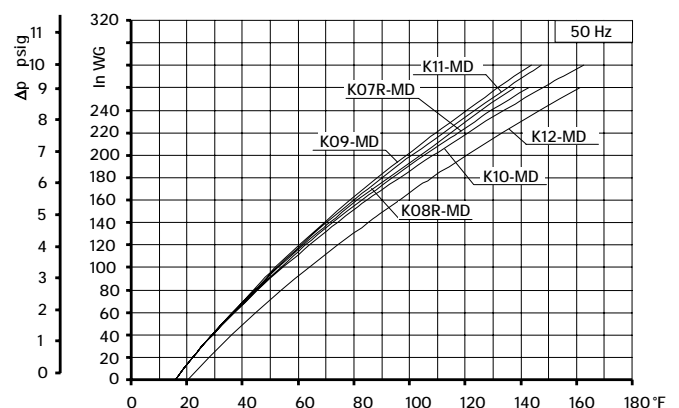
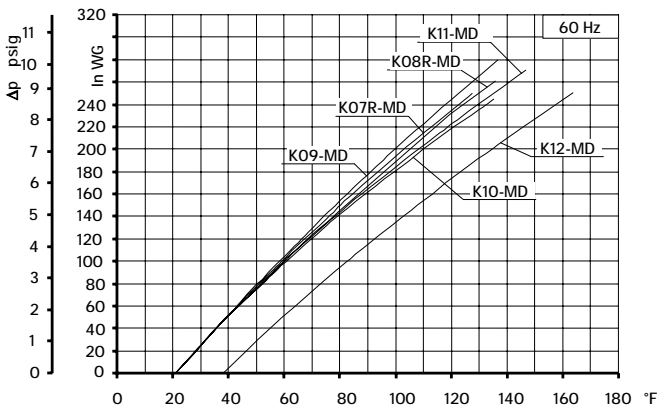
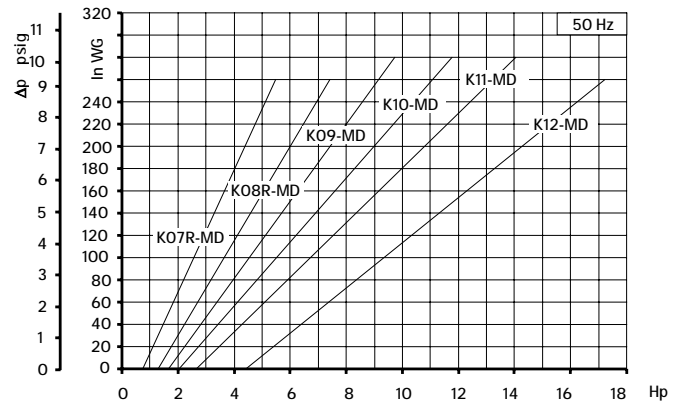
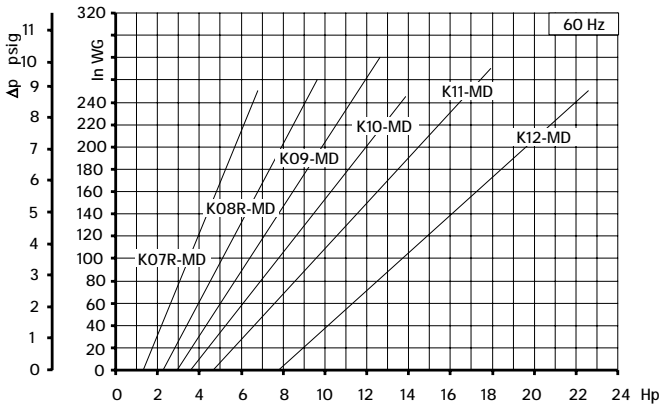
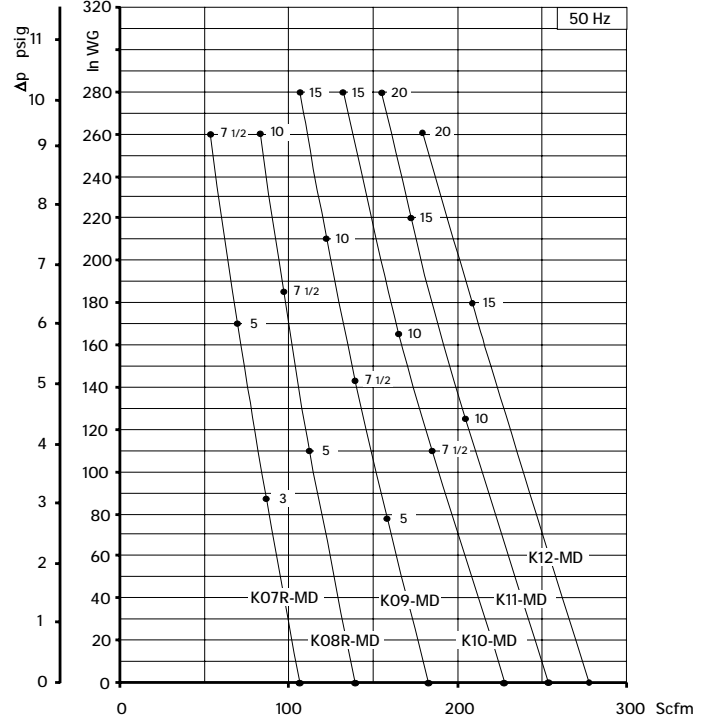
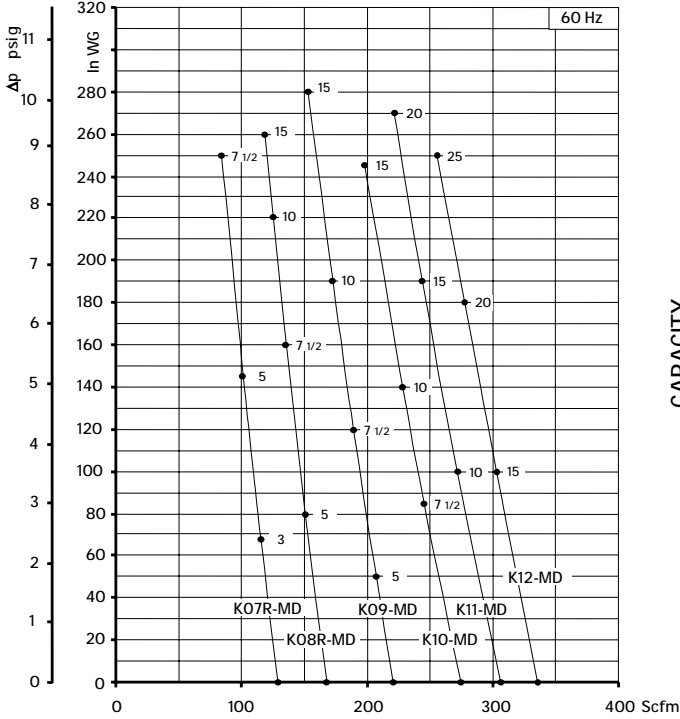

Curves refer to air at 68°F temperature and 29.92 In Hg atmospheric pressure (abs) measured at inlet port.
Values for flow, power consumption and temperature rise: +/-10% tolerance.
Data subject to change without notice.



SCL K07 / K08 / K09 / K10 / K11 / K12

TD SERIES - GOR RANGE

SN 2179-4 1/2

TECHNICAL CHARACTERISTICS

- Aluminium alloy construction
- Smooth operation
- High efficiency impeller
- Maintenance free
- Mountable in any position
- G1/8" female thread on both suction and discharge silencer port flanges

OPTIONS

- Special voltages (IEC 38)
- Surface treatments

ACCESSORIES

- Inlet and/or inline filters
- Additional inlet/outlet silencers
- Safety valves
- Flow converting device
- Optional connectors

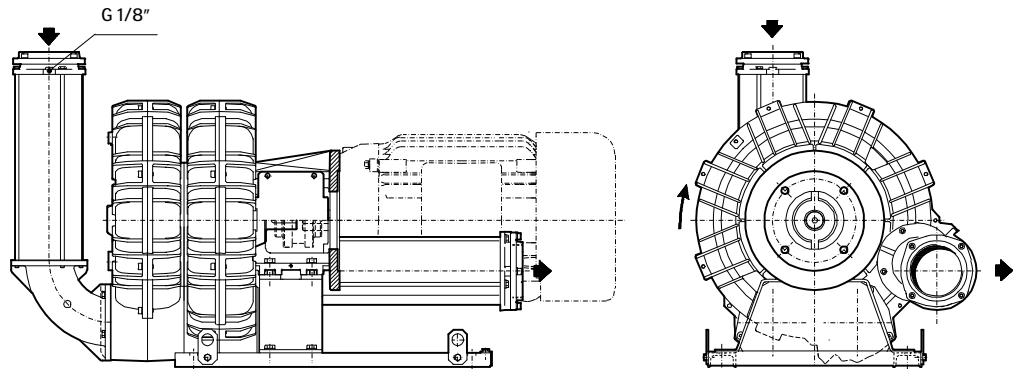

For dimensions, please refer to drw: SI 1971

Model	Maximum flow Scfm		Installed power Hp	Size	Maximum differential pressure Δp (In WG)		Noise level Lp dB (A) ⁽¹⁾		Weight (2) Lbs	
	60 Hz 3500 rpm	50 Hz 2900 rpm			60 Hz 3500 rpm	50 Hz 2900 rpm	60 Hz 3500 rpm	50 Hz 2900 rpm		
K07-TD	296	245	7 1/2	NEMA 182-4TC	90	130	80.9	78.9	156.50	
				NEMA 213-5TC						
			10	NEMA 213-5TC	135	185	81.2	79.2		156.50
			15	NEMA 254-6TC	225	230	81.8	79.8		160.90
20	NEMA 254-6TC	240	82.1	160.90						
K08-TD	368	305	10	NEMA 213 -5TC	95	140	80.4	78.4	169.80	
			15	NEMA 213-5TC	170	220	81.5	79.5	169.00	
			20	NEMA 254-6TC					220	82.3
K09-TD	467	387	15	NEMA 213-5TC	105	155	82.7	80.7	196.20	
				NEMA 254-6TC					201.70	
			20	NEMA 254-6TC	160	225	83.0	81.0	201.70	
			25	NEMA 284-6TSC	220	240	83.3	81.3	198.40	
30	NEMA 284-6TSC	240	83.6	81.6					198.40	
K10-TD	571	473	15	NEMA 213-5TC	85	130	86.6	84.6	202.80	
				NEMA 254-6TC					209.50	
			20	NEMA 254-6TC	130	180	86.9	84.9	209.50	
			25	NEMA 284-6TSC	180	240	87.2	85.2	205.00	
			30	NEMA 284-6TSC	200		87.5		205.00	
40	NEMA 324-6TSC	240	87.8	220.50						
K11-TD	642	532	20	NEMA 254-6TC	90	140	87.4	85.4	246.80	
			25	NEMA 284-6TSC	130	180	87.9	85.9	244.70	
			30	NEMA 284-6TSC	150	240	88.4	86.4	244.70	
			40	NEMA 324-6TSC	240		88.9		264.50	
K12-TD	716	593	25	NEMA 284-6TSC	85	140	88.2	86.2	242.5	
			30	NEMA 284-6TSC	120	190	88.7	86.7	242.5	
			40	NEMA 324-6TSC	190	240	89,2	87.2	262.3	
			50	NEMA 324-6TSC	240	-	89.5	-	262.3	

(1) Noise measured at 1 m distance with inlet and outlet ports piped, in accordance to ISO 3744.

(2) Value is referred to weight of the machine without electric motor

- For proper use, the blower should be equipped with inlet filter and safety valve; other accessories available on request.
- Ambient temperature from +5° to +104°F.
- Specifications subject to change without notice.



SCL K07 / K08 / K09 / K10 / K11 / K12
TD SERIES - GOR RANGE

SN 2179-4 2/2

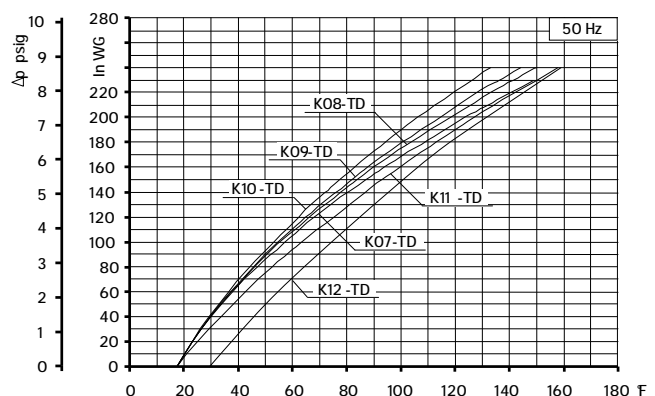
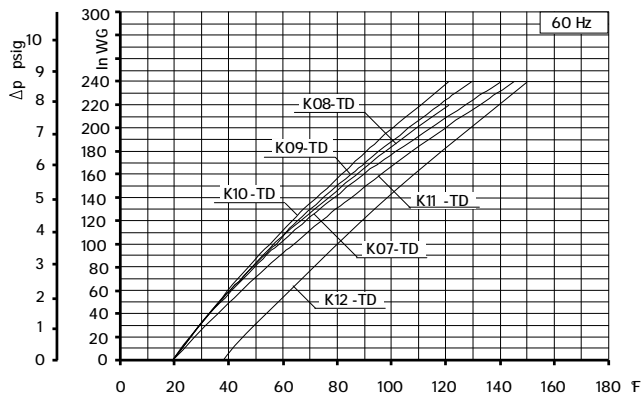
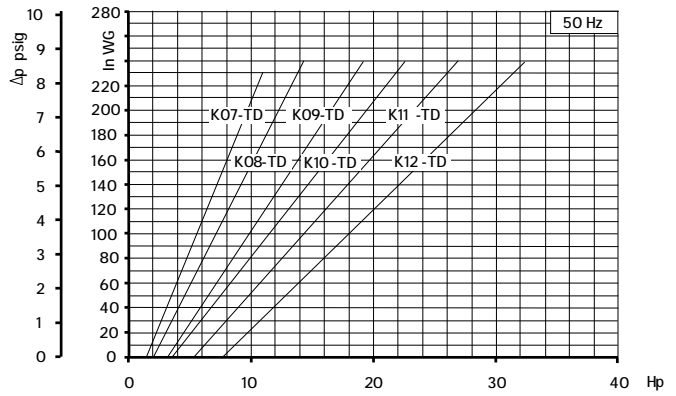
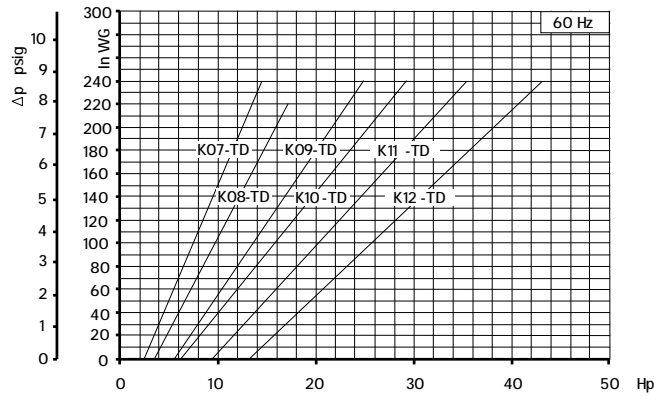
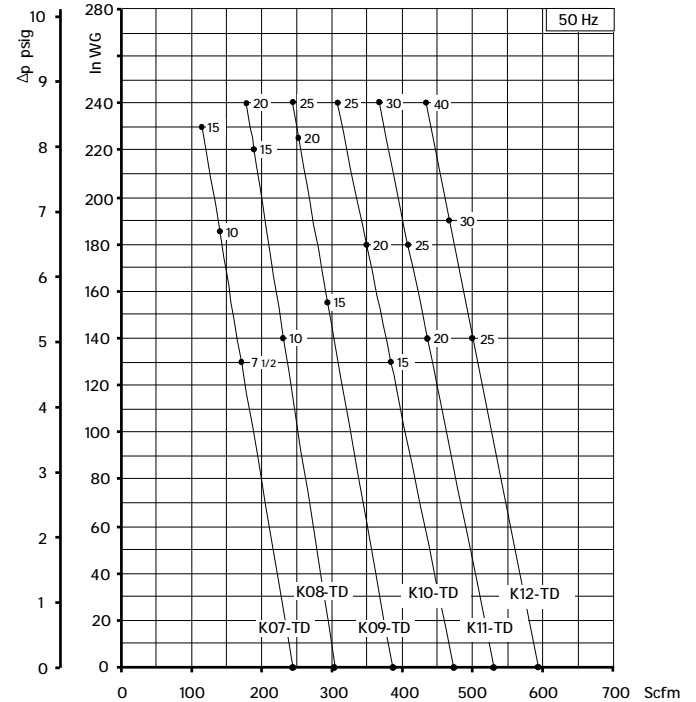
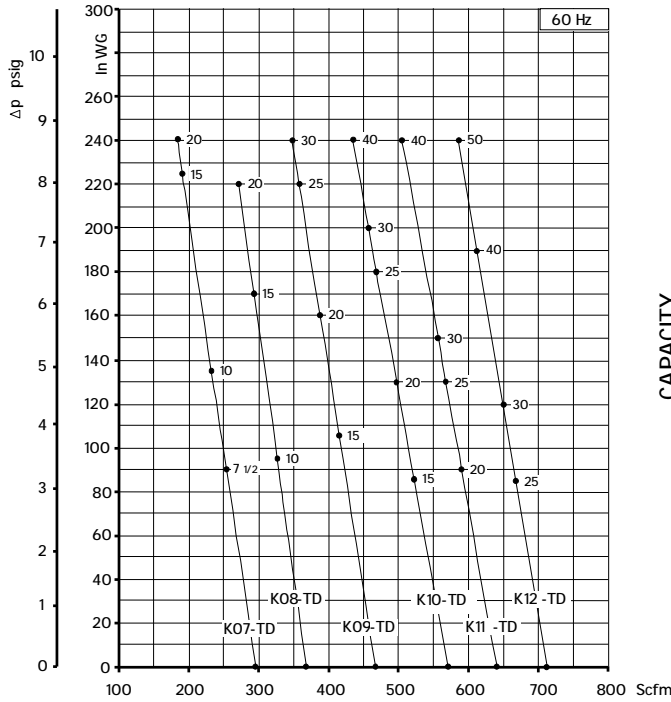

Curves refer to air at 68°F temperature and 29.92 In Hg atmospheric pressure (abs) measured at inlet port.
Values for flow, power consumption and temperature rise +/-10% tolerance.
Data subject to change without notice.



TECHNICAL CHARACTERISTICS

- Aluminium alloy construction
- Smooth operation
- High efficiency impeller
- Maintenance free
- Mountable in any position
- Recognized TEFC - cURus motor

OPTIONS

- Special voltages (IEC 38)
- Surface treatments

ACCESSORIES

- Inlet and/or inline filters
- Additional inlet/outlet silencers
- Safety valves
- Flow converting device
- Optional connectors

Dimensions in inches.

Dimension for reference only.

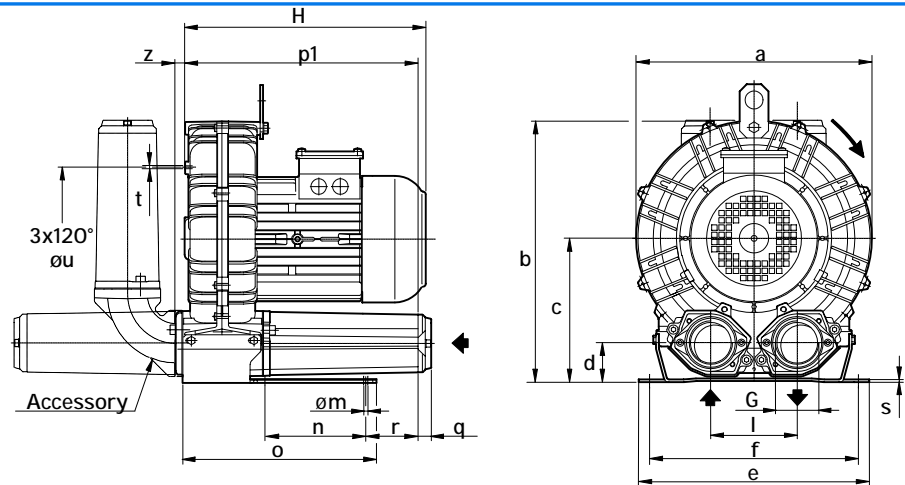

Model	a	b	c	d	e	f	G	l	m	n	o	p1	q	r	s	t	u	z
K03-MS	9.49	10.55	5.79	1.69	9.06	8.07	1" ¼ NPT	3.39	0.39	3.27	5.59	8.07	0.71	2.95	0.16	M6	5.51	0.47
K04-MS	11.22	12.40	6.77	1.93	10.04	8.86	1"½ NPT	4.02	0.47	3.74	6.73	8.74	0.71	2.76	0.16	M6	6.89	0.71
K05-MS	12.87	14.37	7.87	2.13	12.80	10.24	2" NPT	4.72	0.59	4.53	10.43	12.60	0.71	3.86	0.16	M8	7.87	0.75
K06-MS	14.80	15.47	8.07	2.13	12.80	11.42	2" NPT	4.92	0.59	5.51	10.71	13.15	0.71	3.35	0.16	M8	9.45	0.75

Model	Maximum flow cfm		Installed power Hp		Maximum differential pressure Δp (In Hg)		Noise level Lp dB (A) (1)		Overall dimensions H Inches	Weight Lbs
	60 Hz 3500 rpm	50 Hz 2900 rpm	60 Hz 3500 rpm	50 Hz 2900 rpm	60 Hz 3500 rpm	50 Hz 2900 rpm	60 Hz 3500 rpm	50 Hz 2900 rpm		
K03-MS	52	43	3/4	3/4	4.7	3.7	61.0	59.0	10.43	24.3
			1	1	5.9	4.9	61.3	59.3	12.0	32.0
K04-MS	98	81	1 ½	1 ½	4.3	5.9	63.8	61.8	11.65	40.3
			2	2	6.3	6.6	64.0	62.0	14.20	56.8
			3	-	7.4	-	64.2	-	14.20	58.4
K05-MS	156	129	2	2	3.8	5.1	69.5	67.5	13.20	56.7
			3	3	6.6	7.1	69.8	67.8	13.20	60.6
			4	-	8.1	-	70.1	-	14.40	77.2
K06-MS	216	179	3	3	3.7	4.8	72.0	70.0	13.8	69.0
			4	4	5.2	7.0	72.3	70.3	14.17	82.5
			5 ½	5 ½	8.1	8.1	72.6	70.6	15.5	85.3
			6 1/5	-	8.9	-	72.9	-	16.3	95.5

(1) Noise measured at 1 m distance with inlet and outlet ports piped, in accordance to ISO 3744.

- For proper use, the blower should be equipped with inlet filter and safety valve; other accessories available on request.
- Ambient temperature from +5° to +104°F.
- Specifications subject to change without notice.



SCL K03 / K04 / K05 / K06
MS SERIES
SN 1879-14B 2/2

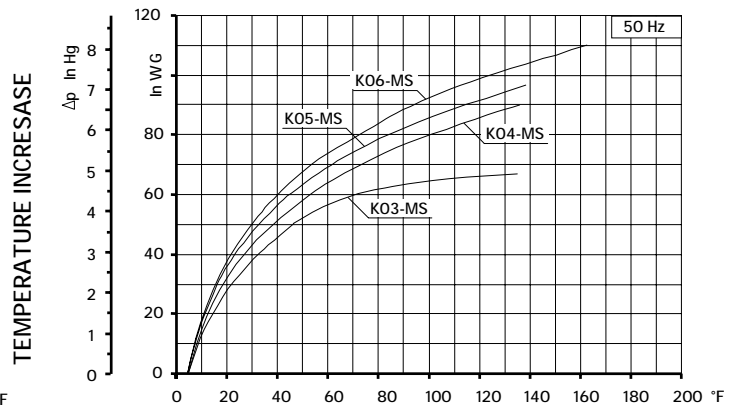
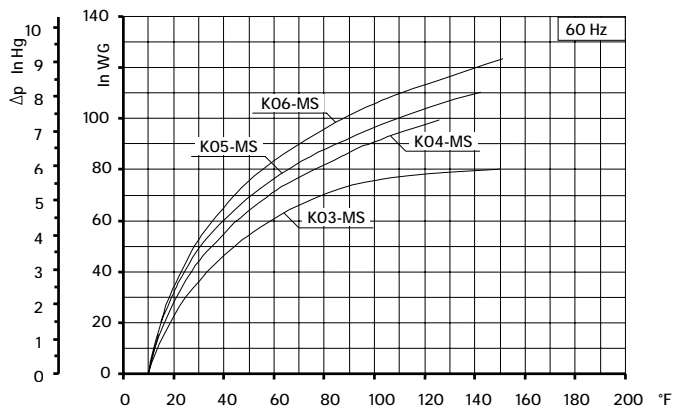
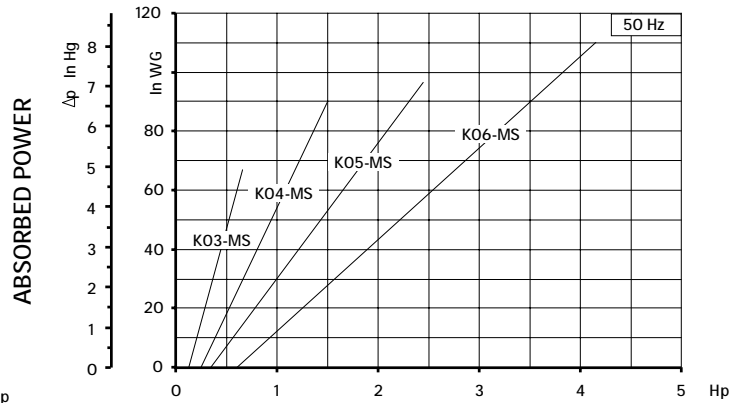
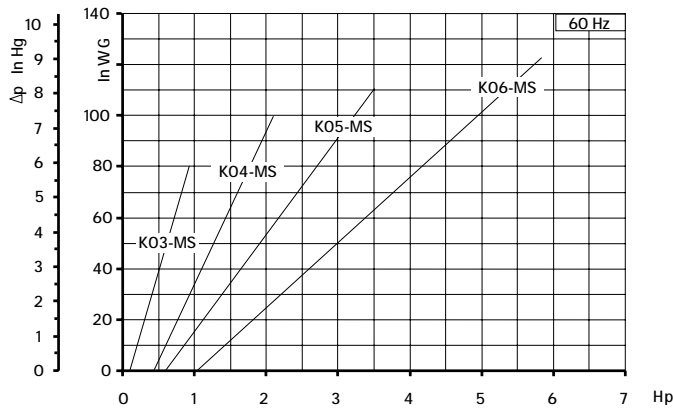
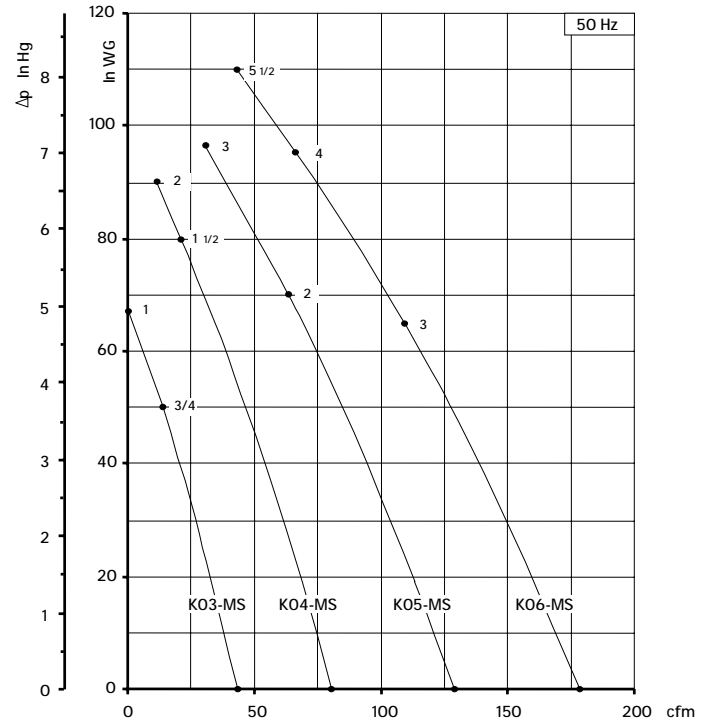
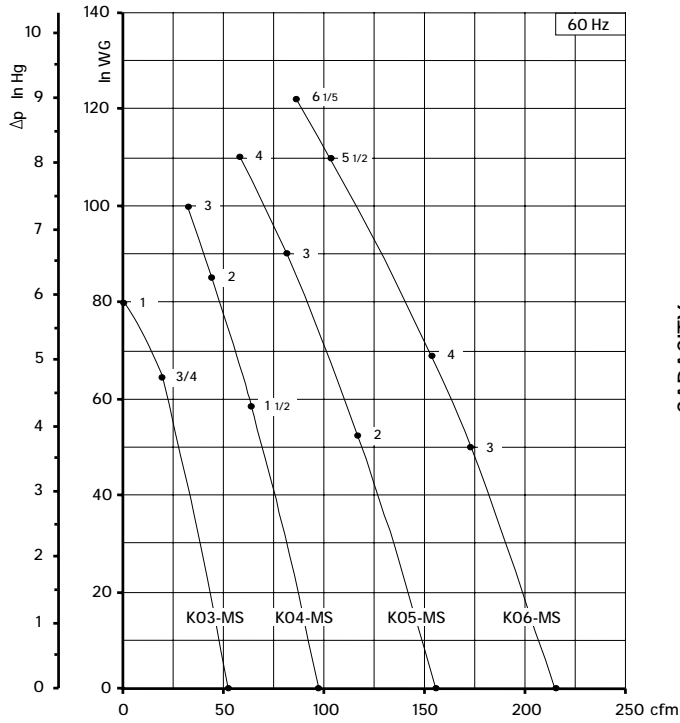

Curves refer to air at 68° F temperature, measured at inlet port and 29.92 In Hg atmospheric back pressure (abs).
Values for flow, power consumption and temperature rise: +/-10% tolerance.
Data subject to change without notice.



SCL K07/ K08 / K09 / K10 / K11 / K12

MS - SERIES

SN 1810-19B 1/2

TECHNICAL CHARACTERISTICS

- Aluminium alloy construction
- Smooth operation
- High efficiency impeller
- Maintenance free
- Mountable in any position
- Recognized TEFC - cURus motor

OPTIONS

- Special voltages (IEC 38)
- Surface treatments

ACCESSORIES

- Inlet and/or inline filters
- Additional inlet/outlet silencers
- Safety valves
- Flow converting device
- Optional connectors

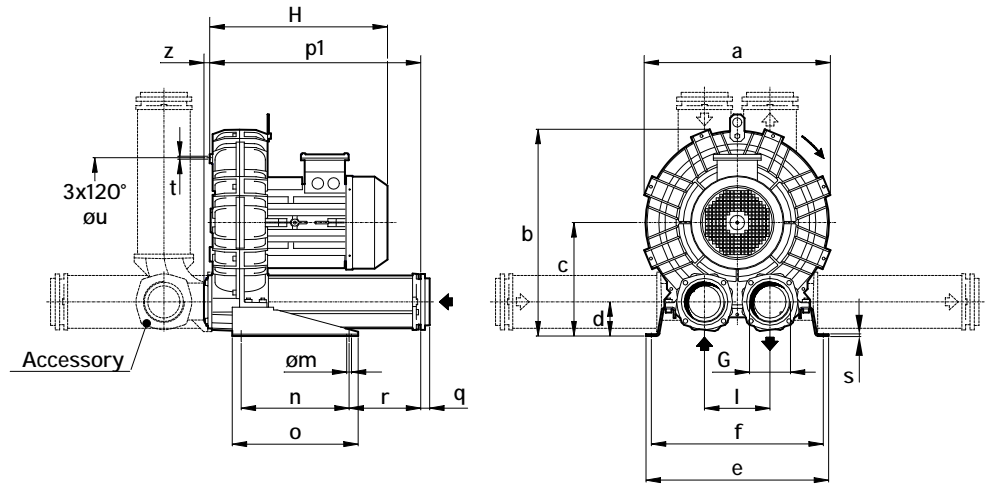

Dimensions in inches.
Dimension for reference only.

Model	a	b	c	d	e	f	G	l	m	n	o	p1	q	r	s	t	u	z
K07-MS	16.69	18.84	10.59	3.23	18.43	17.24	3" NPT	6.10	0.51	11.81	13.78	20.16	0.98	5.39	0.20	M8	11.61	0.63
K08-MS	17.99	19.61	10.59	3.23	18.82	17.64	3" NPT	6.10	0.51	11.81	13.78	20.16	0.98	5.39	0.20	M8	12.2	0.63
K09-MS	19.37	22.09	12.40	3.78	20.00	18.82	4" NPT	7.17	0.51	11.81	13.78	23.07	0.98	7.83	0.20	M8	14.17	0.63
K10-MS	20.31	22.56	12.40	3.78	20.00	18.82	4" NPT	7.17	0.51	11.81	13.78	23.07	0.98	7.83	0.20	M8	14.17	0.63
K11-MS	21.34	23.74	13.07	3.58	21.26	20.00	4" NPT	7.87	0.51	11.81	13.78	23.46	0.98	8.03	0.20	M8	15.35	0.63
K12-MS	21.57	23.82	13.07	3.58	21.26	20.00	4" NPT	7.87	0.51	11.81	13.78	23.58	0.98	8.03	0.20	M8	15.35	0.51

Model	Maximum flow cfm		Installed power Hp		Maximum differential pressure Δp (In Hg)		Noise level Lp dB (A) (1)		Overall dimensions H Inches	Weight Lbs
	60 Hz 3500 rpm	50 Hz 2900 rpm	60 Hz 3500 rpm	50 Hz 2900 rpm	60 Hz 3500 rpm	50 Hz 2900 rpm	60 Hz 3500 rpm	50 Hz 2900 rpm		
K07-MS	294	243	4	4	3.0	4.6	77.7	75.7	15.6	116.2
			5 1/2	5 1/2	5.6	6.3	78.0	76.0	16.3	119.0
			7 1/2	7 1/2	8.9	8.9	78.3	76.3	18.4	160.5
			10	-	10.3	-	78.6	-	19.1	172.6
K08-MS	381	316	5 1/2	5 1/2	3.0	3.8	78.8	76.8	16.3	124.8
			7 1/2	7 1/2	5.2	6.6	79.1	77.1	18.4	166.5
			10	10	8.1	9.2	79.4	77.4	19.1	179.0
			15	-	9.6	-	79.7	-	19.1	192.0
K09-MS	471	390	7 1/2	7 1/2	3.7	4.6	79.3	77.3	18.8	186.3
			10	10	5.9	7.0	79.6	77.6	19.5	245.0
			15	15	9.6	10.4	80.1	78.1	22.0	212.0
K10-MS	556	460	7 1/2	7 1/2	2.4	3.8	79.4	77.4	18.8	189.6
			10	10	4.4	5.9	79.7	77.7	19.5	202.0
			15	15	8.1	9.9	80.2	78.2	19.6	215.0
			20	-	9.6	-	80.5	-	22.0	248.0
K11-MS	650	539	15	15	5.9	8.9	82.5	80.5	19.8	226.0
			20	20	11.0	10.4	83.0	81.0	22.5	259.0
K12-MS	726	602	15	15	3.0	6.6	83.5	81.5	19.9	229.5
			20	20	6.2	9.6	84.3	82.3	22.5	263.0
			25	-	8.9	-	87.2	-	24.0	337.0

(1) Noise measured at 1 m distance with inlet and outlet ports piped, in accordance to ISO 3744.

- For proper use, the blower should be equipped with inlet filter and safety valve; other accessories available on request.
- Ambient temperature from +5° to +104°F.
- Specifications subject to change without notice.



SCL K07 / K08 / K09 / K10 / K11 / K12
MS SERIES
SN 1810-19B 2/2

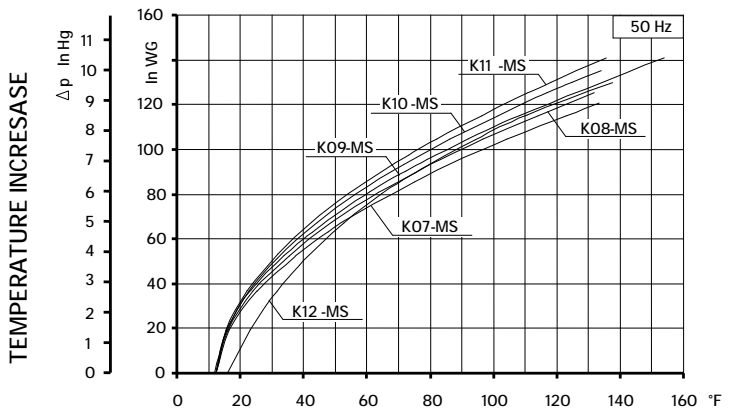
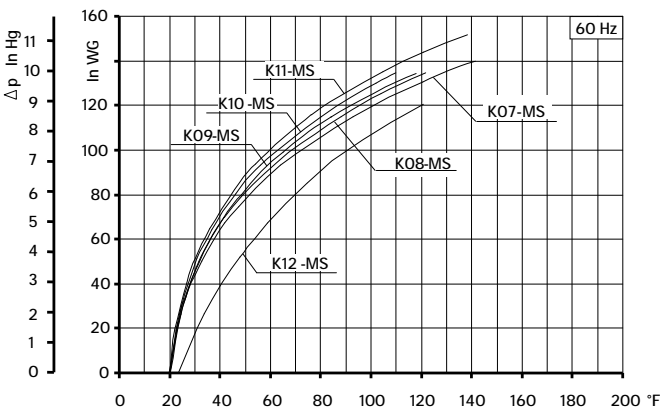
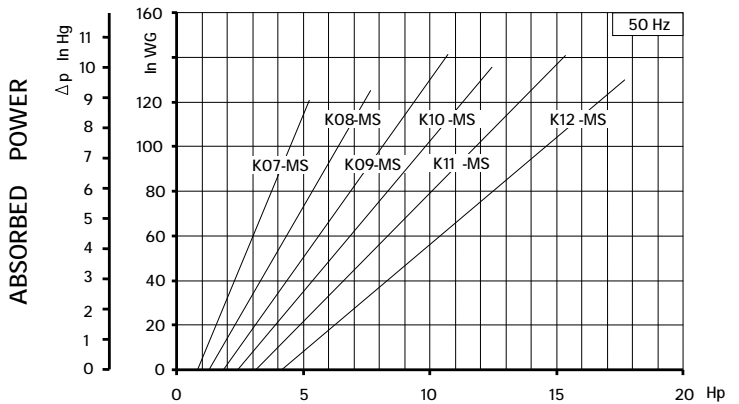
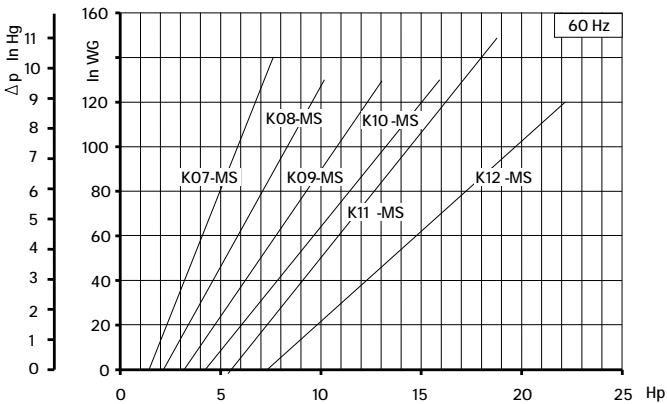
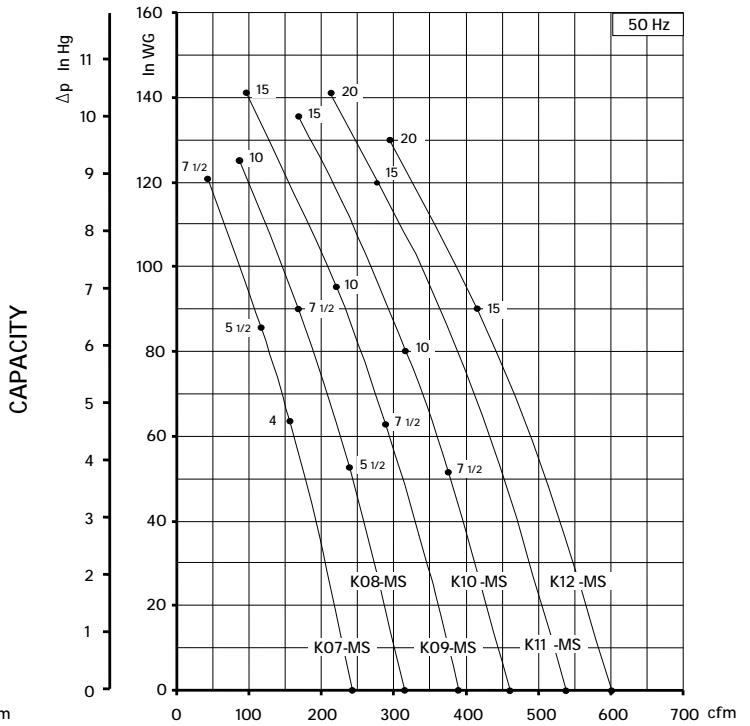
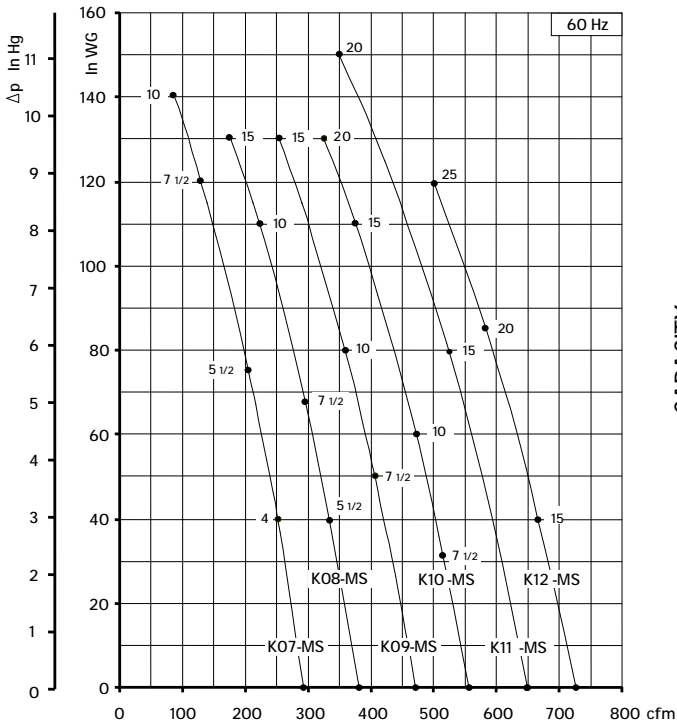

Curves refer to air at 68° F temperature, measured at inlet port and 29.92 In Hg atmospheric backpressure (abs).
Values for flow, power consumption and temperature rise: +/-10% tolerance.
Data subject to change without notice.

TECHNICAL CHARACTERISTICS

- Aluminium alloy construction
- Smooth operation
- High efficiency impeller
- Maintenance free
- Mountable in any position
- Recognized TEFC-cURus motor

OPTIONS

- Special voltages (IEC 38)
- Surface treatments

ACCESSORIES

- Inlet and/or inline filters
- Additional inlet/outlet silencers
- Safety valves
- Flow converting device
- Optional connectors

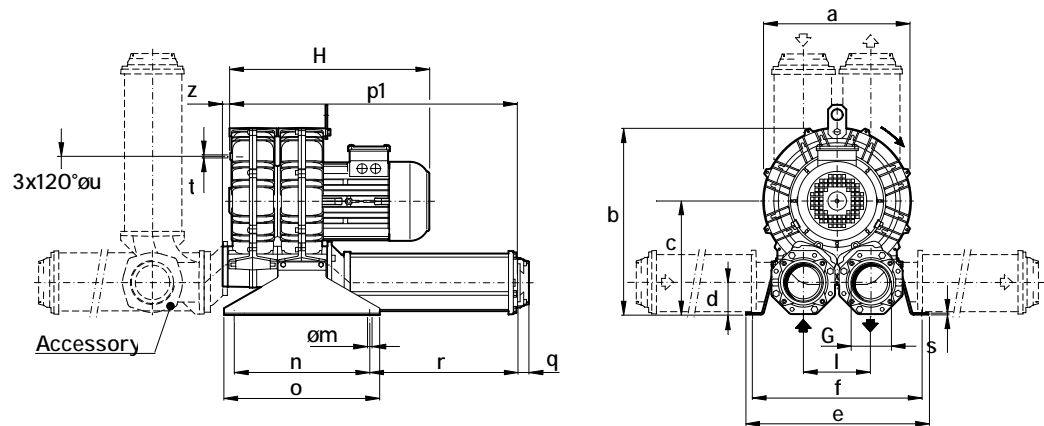

Dimensions in inches.

Dimension for reference only.

Model	a	b	c	d	e	f	G	l	m	n	o	pl	q	r	s	t	u	z
K05-TS	12.87	16.61	10.16	3.03	15.91	14.72	3" NPT	5.91	0.51	11.81	13.58	24.96	0.98	12.91	0.16	M8	7.87	0.75
K06-TS	14.80	17.72	10.31	2.95	15.91	14.72	3" NPT	6.10	0.51	11.81	13.58	26.06	0.98	13.19	0.16	M8	9.45	0.75

Model	Maximum flow cfm		Installed power Hp		Maximum differential pressure Δp (In Hg)		Noise level Lp dB (A) (1)		Overall dimensions H Inches	Weight Lbs
	60 Hz 3500 rpm	50 Hz 2900 rpm	60 Hz 3500 rpm	50 Hz 2900 rpm	60 Hz 3500 rpm	50 Hz 2900 rpm	60 Hz 3500 rpm	50 Hz 2900 rpm		
K05-TS	290	241	5 ½	5 ½	5.3	6.6	75.1	73.1	19.5	109.0
			5 ½	5 ½	2.7	4.0	76.8	74.8		
K06-TS	400	331	7 ½	7 ½	4.0	5.9	77.1	75.1	23.0	168.8
			10	10	6.3	7.4	77.4	75.4		

(1) Noise measured at 1 m distance with inlet and outlet ports piped, in accordance to ISO 3744.

- For proper use, the blower should be equipped with inlet filter and safety valve; other accessories available on request.
- Ambient temperature from +5° to +104°F.
- Specifications subject to change without notice.



SCL K05 / K06
TS SERIES
SN 1926-8B 2/2

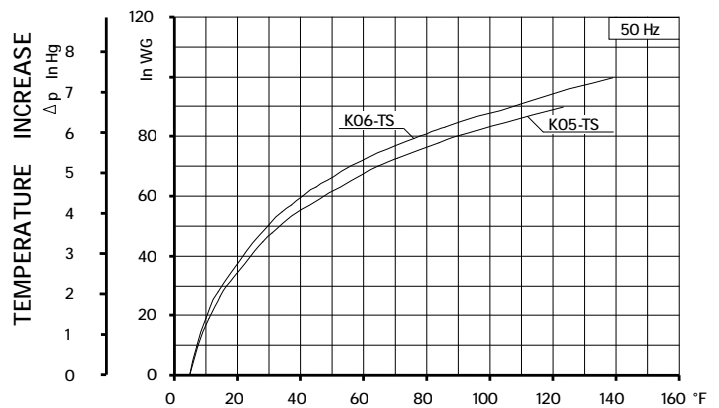
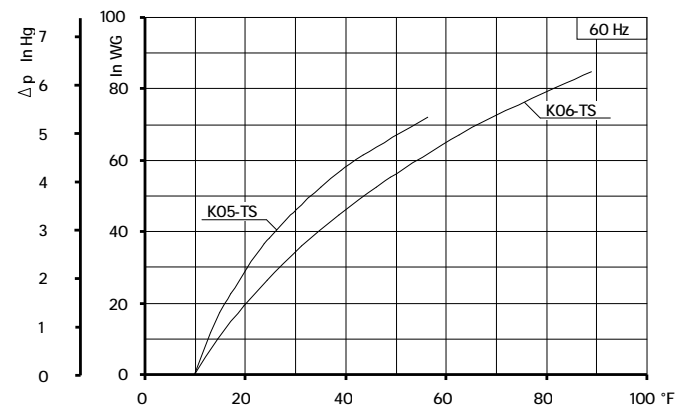
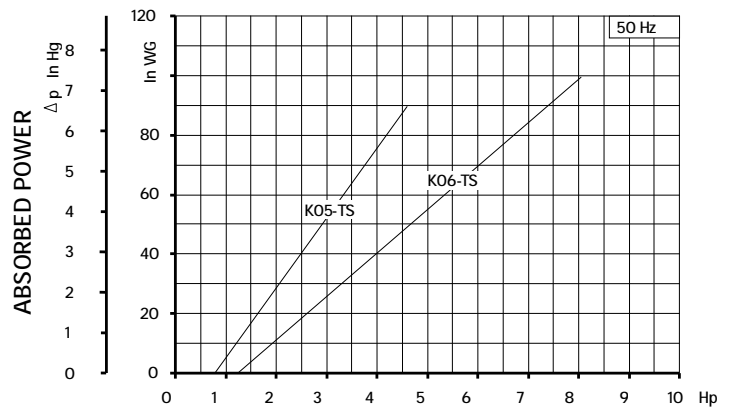
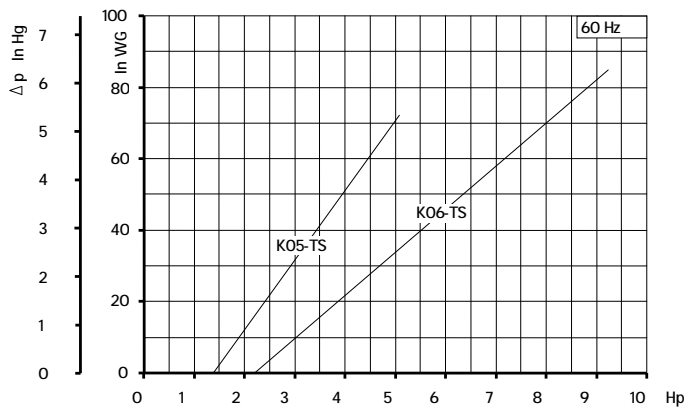
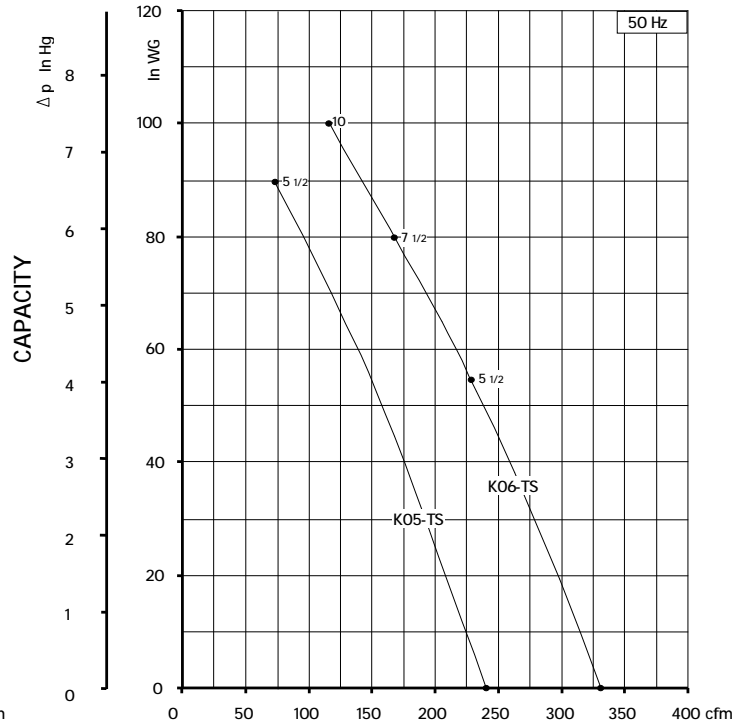
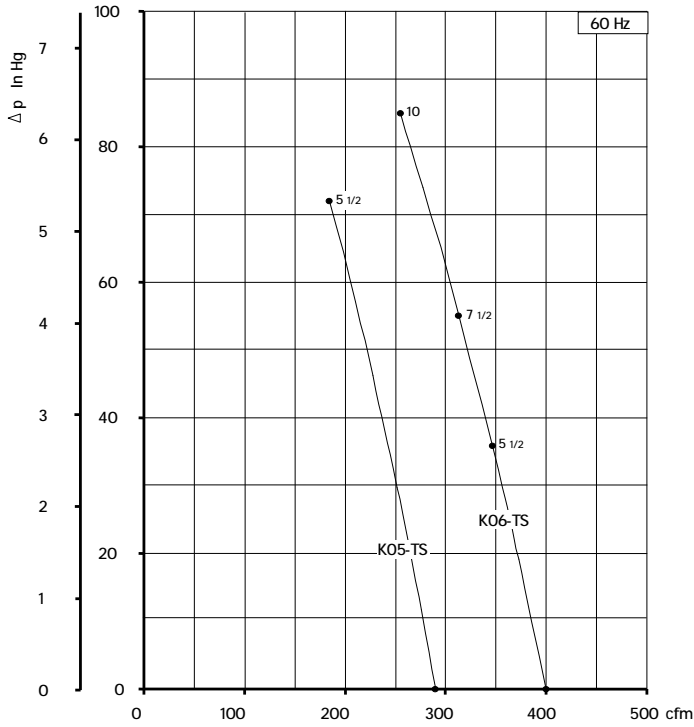

Curves refer to air at 68° F temperature, measured at inlet port and 29.92 In Hg atmospheric backpressure (abs).
 Values for flow, power consumption and temperature rise: +/- 10% tolerance.
 Data subject to change without notice.



SCL K07 / K08 / K09 / K10 / K11 / K12

TS SERIES

SN 1826-16B

TECHNICAL CHARACTERISTICS

- Aluminium alloy construction
- Smooth operation
- High efficiency impeller
- Maintenance free
- Mountable in any position
- Recognized TEFC-cURus motor
- G1/8" female thread on both suction and discharge silencer port flanges

OPTIONS

- Special voltages (IEC 38)
- Surface treatments

ACCESSORIES

- Inlet and/or inline filters
- Additional inlet/outlet silencers
- Safety valves
- Flow converting device
- Optional connectors

Dimensions in inches.

Dimension for reference only.

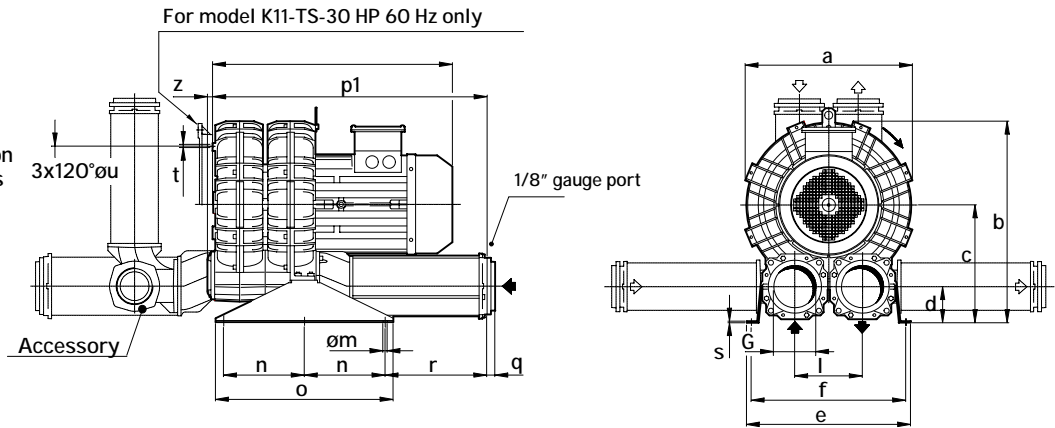

Model	a	b	c	d	e	f	G	l	m	n	o	p1	q	r	s	t	u	z
K07-TS	16.69	20.91	12.56	3.86	18.50	17.24	4" NPT	7.17	0.51	9.84	21.65	31.57	0.98	11.77	0.20	M8	11.61	0.63
K08-TS	17.99	21.57	12.56	3.86	18.90	17.64	4" NPT	7.17	0.51	9.84	21.65	31.57	0.98	11.77	0.20	M8	12.20	0.63
K09-TS	19.37	24.02	14.37	4.41	20.08	18.82	5" NPT	8.27	0.51	9.84	21.65	33.46	1.38	12.40	0.20	M8	14.17	0.63
K10-TS	20.31	24.53	14.37	4.41	20.08	18.82	5" NPT	8.27	0.51	9.84	21.65	33.46	1.38	12.40	0.20	M8	14.17	0.63
K11-TS	21.34	25.59	14.96	4.17	21.26	20.00	5" NPT	8.98	0.51	9.84	21.65	34.25	1.38	12.60	0.20	M8	15.35	0.63
K12-TS	21.57	25.71	14.96	4.17	21.26	20.00	5" NPT	8.98	0.51	9.84	21.65	34.8	1.38	12.60	0.20	M8	15.4	0.63

Model	Maximum flow cfm		Installed power Hp		Maximum differential pressure Δp (In Hg)		Noise level Lp dB (A) (1)		Overall dimensions H Inches	Weight Lbs
	60 Hz 3500 rpm	50 Hz 2900 rpm	60 Hz 3500 rpm	50 Hz 2900 rpm	60 Hz 3500 rpm	50 Hz 2900 rpm	60 Hz 3500 rpm	50 Hz 2900 rpm		
K07-TS	588	487	7 1/2	7 1/2	2.6	4.4	83.9	81.9	23.0	218.3
			10	10	4.4	6.6	84.2	82.2	24.5	230.4
			15	15	8.1	8.1	84.8	82.8	24.5	243.7
K08-TS	715	592	15	15	4.4	6.4	83.3	81.3	24.5	256.0
K09-TS	941	780	20	20	5.9	7.4	85.0	83.0	31.0	422.0
			25	25	8.1	8.8	87.0	85.0	31.0	432.0
K10-TS	1093	906	20	20	4.4	5.9	88.1	86.1	31.0	429.0
			25	25	5.9	7.4	88.4	86.4	31.0	439.0
K11-TS	1254	1039	25	25	3.4	6.6	89.4	87.4	31.5	469.0
			30	30	5.1	8.1	90.0	88.0	31.5	475.0
K12-TS	1410	1168	30	30	3.3	5.9	90.6	88.6	32.0	475.0

(1) Noise measured at 1 m distance with inlet and outlet ports piped, in accordance to ISO 3744.

(2) K11-TS-30 HP vertical assembly only.

- For proper use, the blower should be equipped with inlet filter and safety valve; other accessories available on request.
- Ambient temperature from +5° to +104°F.
- Specifications subject to change without notice.



SCL K07 / K08 / K09 / K10 / K11 / K12

TS SERIES
SN 1826-16B

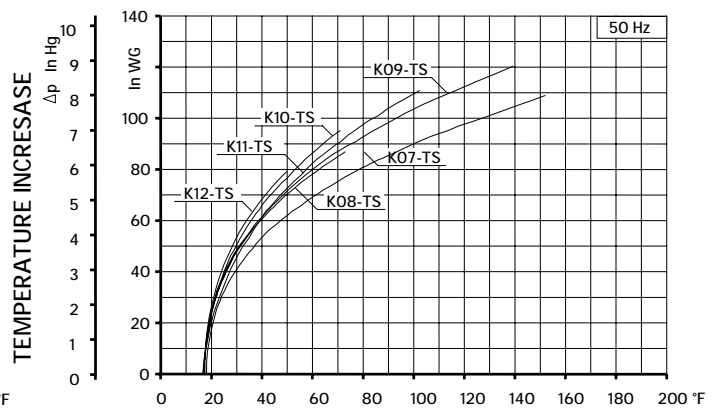
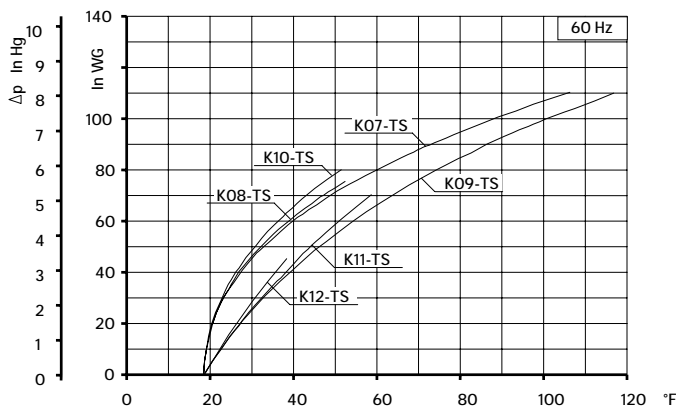
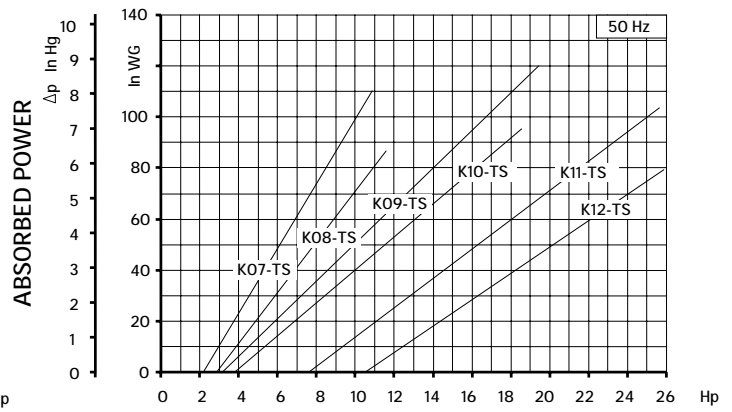
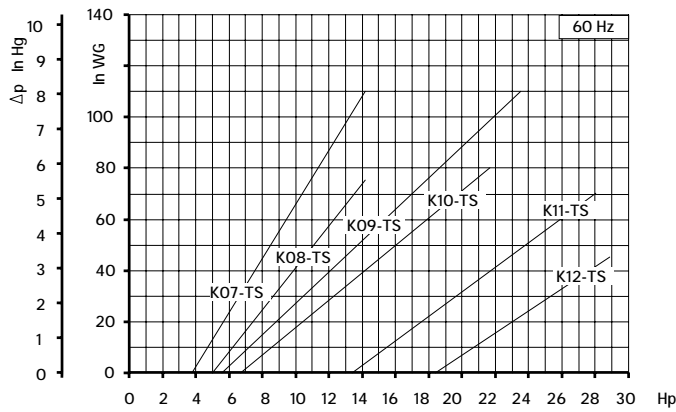
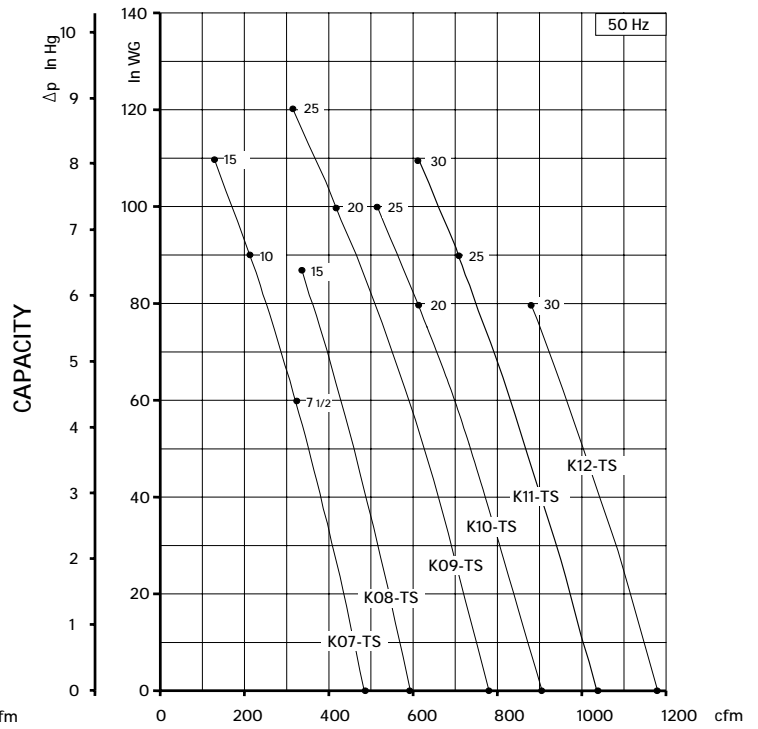
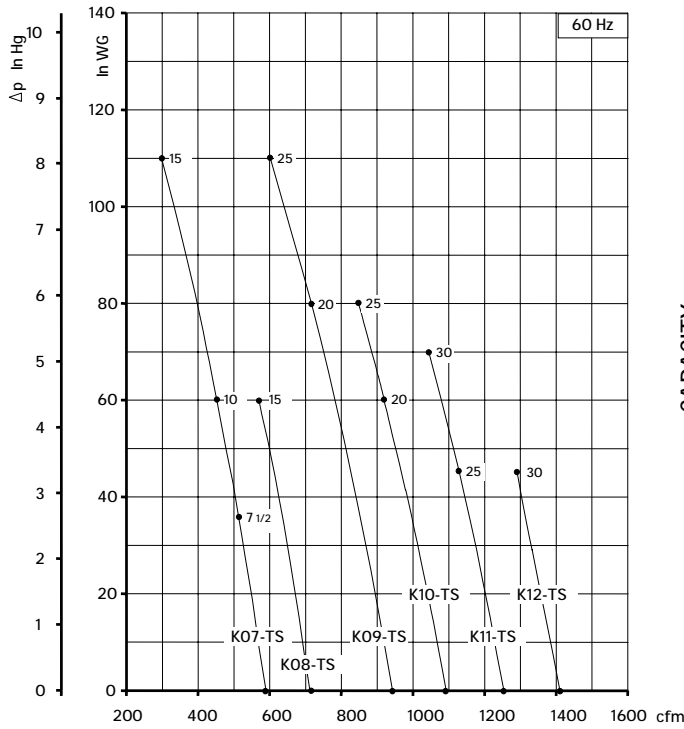

Curves refer to air at 68° F temperature, measured at inlet port and 29.92 In Hg atmospheric backpressure (abs).
Values for flow, power consumption and temperature rise: +/-10% tolerance.
Data subject to change without notice.



SCL K07R / K08R / K09 / K10 / K11 / K12

MD SERIES

SN 1852-13B 1/2

TECHNICAL CHARACTERISTICS

- Aluminium alloy construction
- Smooth operation
- High efficiency impeller
- Maintenance free
- Mountable in any position
- Recognized TEFC - cURus motor

OPTIONS

- Special voltages (IEC 38)
- Surface treatments

ACCESSORIES

- Inlet and/or inline filters
- Additional inlet/outlet silencers
- Safety valves
- Flow converting device
- Optional connectors

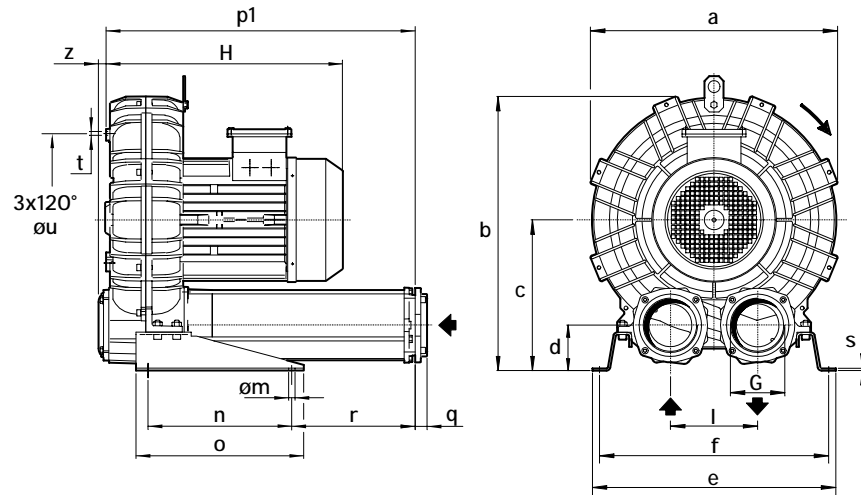

Dimensions in inches.
Dimension for reference only.

Model	a	b	c	d	e	f	G	l	m	n	o	p1	q	r	s	t	u	z
K07R-MD	16.69	18.94	10.59	3.23	18.43	17.24	2" NPT	6.10	0.51	11.81	13.78	16.46	0.71	1.70	0.20	M8	11.61	0.63
K08R-MD	17.99	19.61	10.59	3.23	18.82	17.64	2" NPT	6.10	0.51	11.81	13.78	16.46	0.71	1.70	0.20	M8	12.20	0.63
K09-MD	19.37	22.09	12.40	3.78	20.00	18.82	4" NPT	7.17	0.51	11.81	13.78	25.35	0.98	10.12	0.20	M8	14.17	0.63
K10-MD	20.31	22.56	12.40	3.78	20.00	18.82	4" NPT	7.17	0.51	11.81	13.78	25.35	0.98	10.12	0.20	M8	14.17	0.63
K11-MD	21.35	23.74	13.07	3.58	21.18	20.00	4" NPT	7.87	0.51	11.81	13.78	25.75	0.98	10.31	0.20	M8	15.35	0.63
K12-MD	21.57	23.85	13.07	3.58	21.18	20.00	4" NPT	7.87	0.51	11.81	13.78	25.87	0.98	10.31	0.20	M8	15.35	0.62

Model	Maximum flow cfm		Installed power Hp		Maximum differential pressure Δp (In Hg)		Noise level Lp dB (A) (1)		Overall dimensions H Inches	Weight Lbs
	60 Hz 3500 rpm	50 Hz 2900 rpm	60 Hz 3500 rpm	50 Hz 2900 rpm	60 Hz 3500 rpm	50 Hz 2900 rpm	60 Hz 3500 rpm	50 Hz 2900 rpm		
K07R-MD	129	107	5 1/2	5 1/2	11.8	13.3	74.5	72.5	16.30	117
			7 1/2	7 1/2	13.3	-	75.0	73.0	17.60	159
K08R-MD	168	139	5 1/2	5 1/2	7.4	11.8	76.2	74.2	16.30	125
			7 1/2	7 1/2	11.9	13.3	76.6	74.6	17.60	167
K09-MD	221	183	10	10	13.3	-	77.0	75.0	19.10	179
			10	10	14.0	11.8	79.5	77.5	19.50	210
K10-MD	275	228	10	10	9.6	12.6	80.3	78.3	19.50	214
			15	15	12.6	-	81.4	79.4	19.50	228
K11-MD	306	254	15	15	13.3	12.6	81.4	79.4	19.70	244
			15	15	7.4	12.6	82.3	80.3	19.90	242
K12-MD	336	278	20	20	12.6	-	82.6	80.6	22.50	278

(1) Noise measured at 1 m distance with inlet and outlet ports piped, in accordance to ISO 3744.

- For proper use, the blower should be equipped with inlet filter and safety valve; other accessories available on request.
- Ambient temperature from +5° to +104°F.
- Specifications subject to change without notice.



SCL K07R / K08R / K09 / K10 / K11 / K12

MD SERIES
SN 1852-13B 2/2

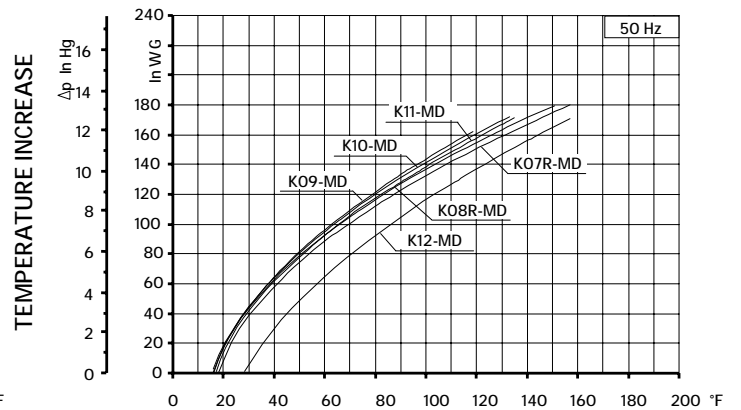
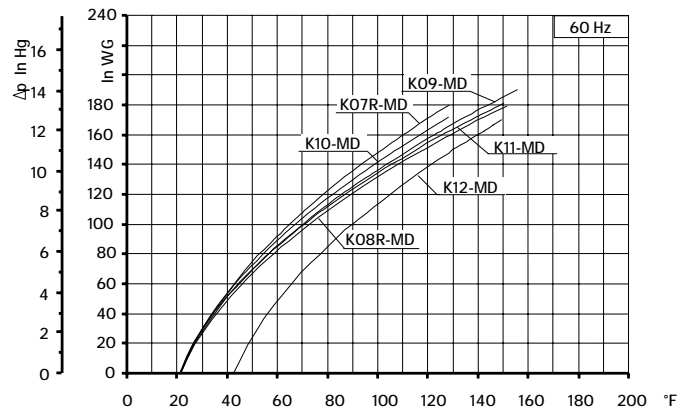
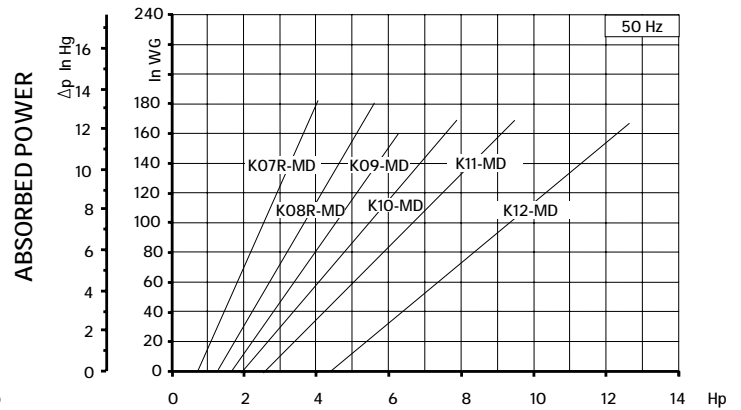
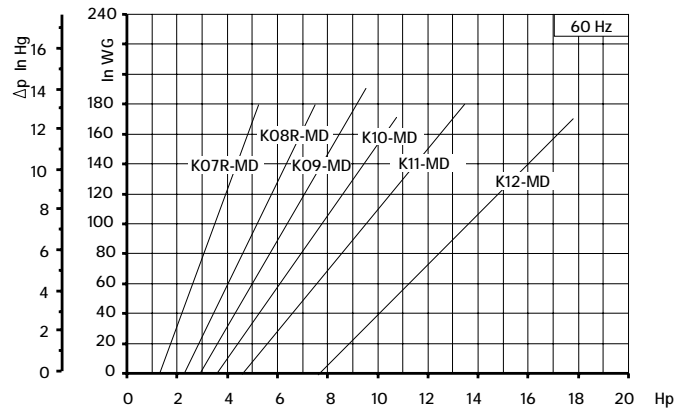
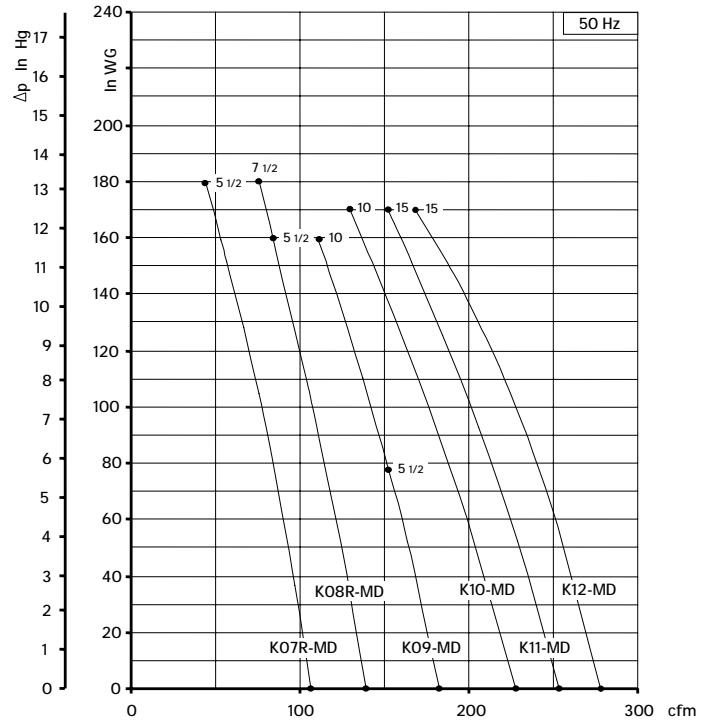
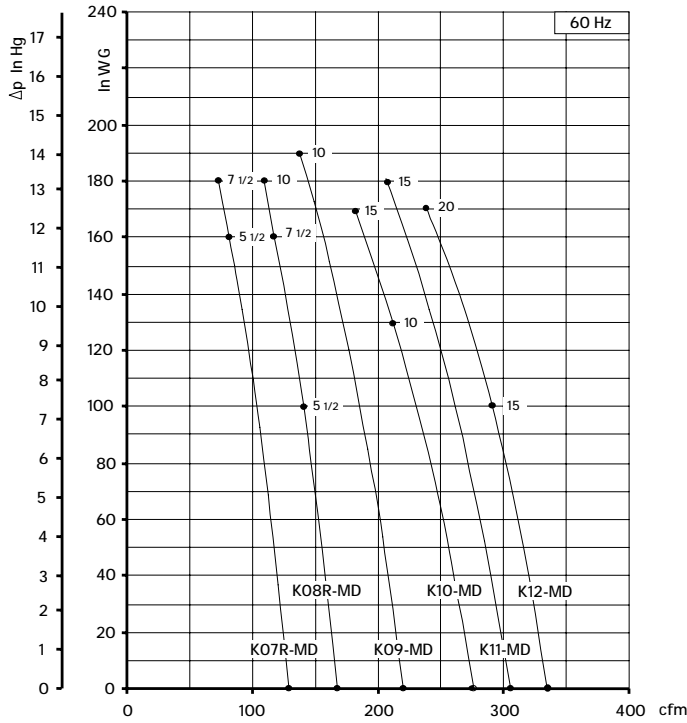

Curves refer to air at 68° F temperature, measured at inlet port and 29.92 In Hg atmospheric backpressure (abs).
Values for flow, power consumption and temperature rise: +/-10% tolerance.
Data subject to change without notice.



SCL K05 / K06

TD SERIES

SN 1936-8B 1/2

TECHNICAL CHARACTERISTICS

- Aluminium alloy construction
- Smooth operation
- High efficiency impeller
- Maintenance free
- Mountable in any position
- Recognized TEFC - cURus motor

OPTIONS

- Special voltages (IEC 38)
- Surface treatments

ACCESSORIES

- Inlet and/or inline filters
- Additional inlet/outlet silencers
- Safety valves
- Flow converting device
- Optional connectors

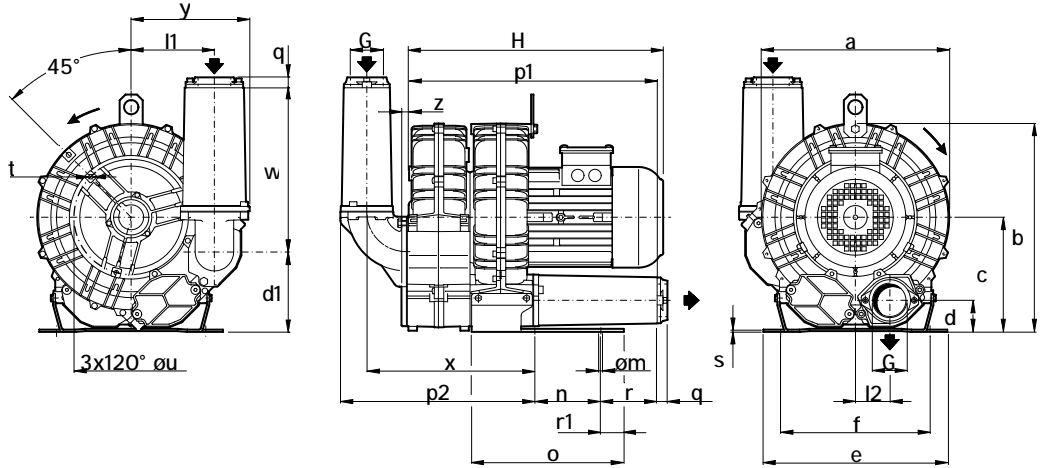

Dimensions in inches.
Dimension for reference only.

Model	a	b	c	d	d1	e	f	G	l1	l2	m	n	o	p1	p2	q	r	r1	s	t	u	w	x	y	z
K05-TD	12.87	14.37	7.87	2.13	5.51	12.60	10.24	2" NPT	5.71	2.36	0.59	4.53	10.43	16.85	13.39	0.71	3.86	1.57	0.16	M8	7.87	11.26	11.54	8.11	0.75
K06-TD	14.80	16.54	9.13	2.32	6.69	12.80	11.42	2" NPT	5.94	2.87	0.59	5.51	10.43	19.92	13.94	0.71	5.35	0.75	0.16	M8	9.45	11.26	12.13	8.27	0.75

Model	Maximum flow cfm		Installed power Hp		Maximum differential pressure Δp (In Hg)		Noise level Lp dB (A) (1)		Overall dimensions H Inches	Weight Lbs
	60 Hz 3500 rpm	50 Hz 2900 rpm	60 Hz 3500 rpm	50 Hz 2900 rpm	60 Hz 3500 rpm	50 Hz 2900 rpm	60 Hz 3500 rpm	50 Hz 2900 rpm		
K05-TD	153	127	5 ½	5 ½	11.0	11.8	75.6	73.6	19.5	101.0
K06-TD	222	184	10	10	11.8	11.8	76.6	74.4	24.5	174.5

(1) Noise measured at 1 m distance with inlet and outlet ports piped, in accordance to ISO 3744.

- For proper use, the blower should be equipped with inlet filter and safety valve; other accessories available on request.
- Ambient temperature from +5° to +104°F.
- Specifications subject to change without notice.



SCL K05 / K06
TD SERIES
SN 1936-BB 2/2

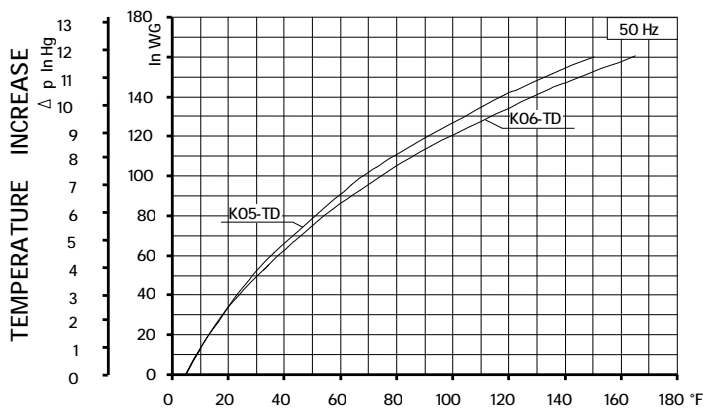
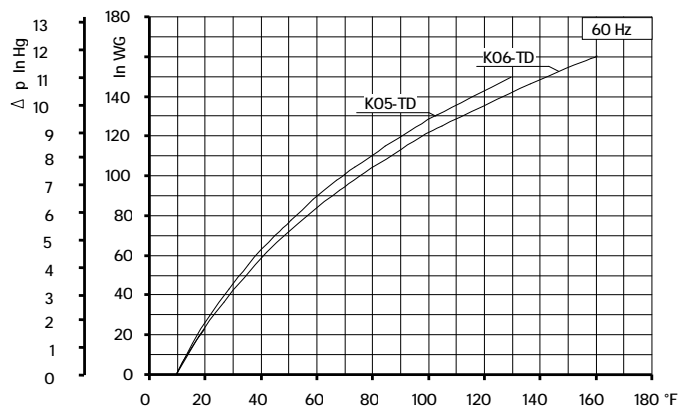
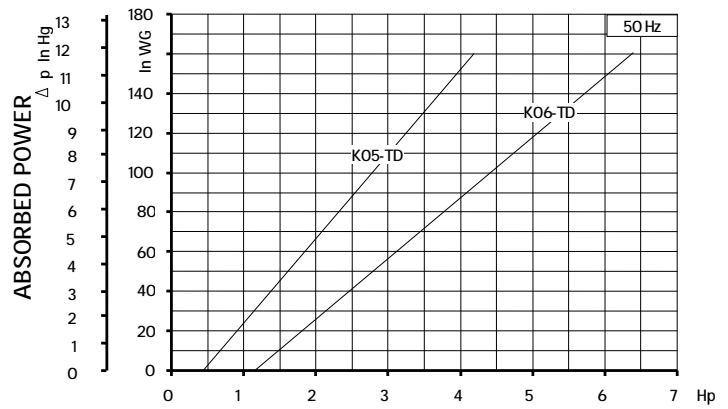
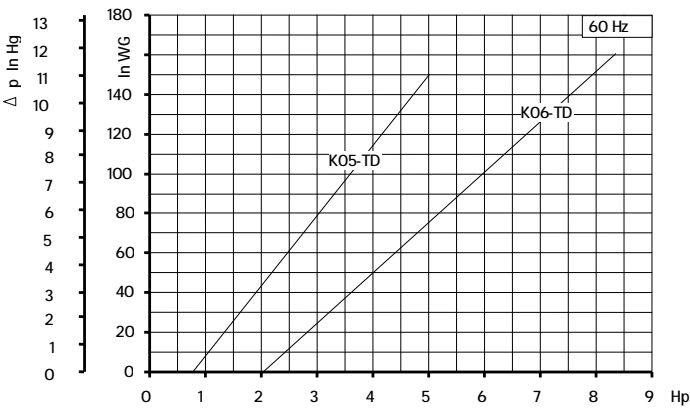
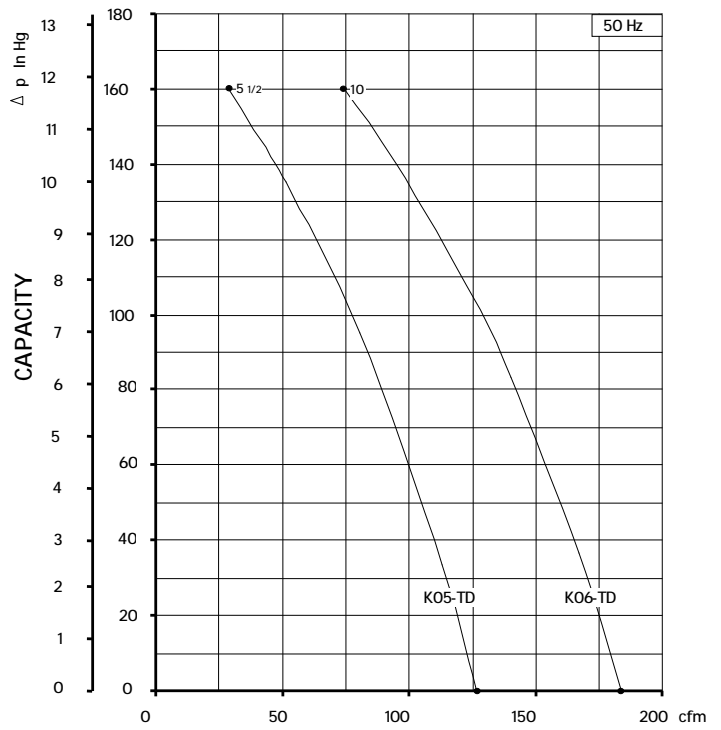
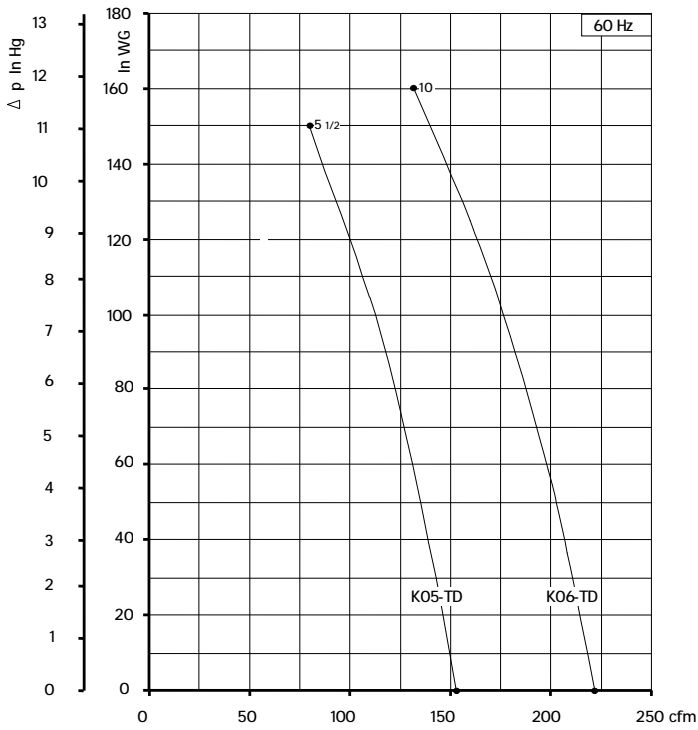

Curves refer to air at 68° F temperature, measured at inlet port and 29.92 In Hg atmospheric backpressure (abs).
 Values for flow, power consumption and temperature rise: +/-10% tolerance.
 Data subject to change without notice.

TECHNICAL CHARACTERISTICS

- Aluminium alloy construction
- Smooth operation
- High efficiency impeller
- Maintenance free
- Mountable in any position
- Recognized TEFC - cURus motor
- G1/8" female thread on both suction and discharge silencer port flanges

OPTIONS

- Special voltages (IEC 38)
- Surface treatments

ACCESSORIES

- Inlet and/or inline filters
- Additional inlet/outlet silencers
- Safety valves
- Flow converting device
- Optional connectors

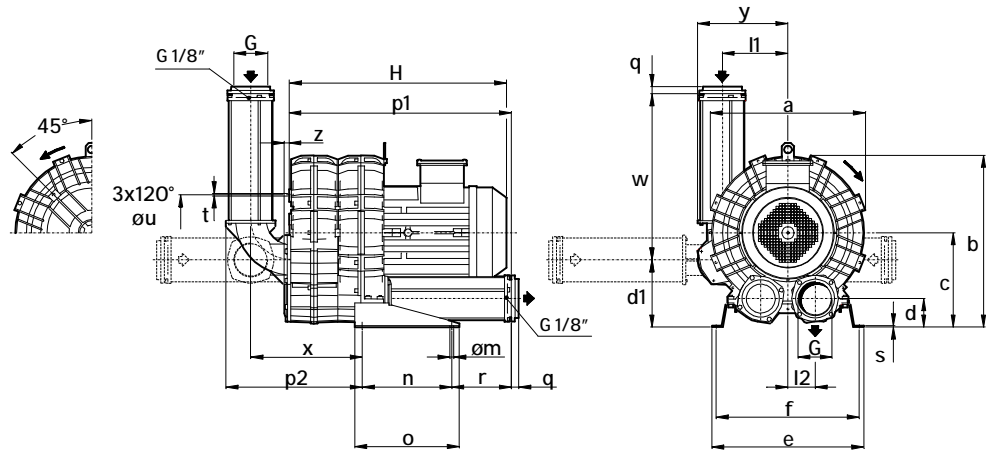

Dimensions in inches.

Dimension for reference only.

Model	a	b	c	d	d1	e	f	G	l1	l2	m	n	o	p1	p2	q	r	s	t	u	w	x	y	z
K07-TD	16.69	18.94	10.59	3.23	7.56	18.43	17.24	3"NPT	7.36	3.05	0.51	11.81	13.78	25.55	15.43	0.98	5.39	0.20	M8	11.61	18.94	12.56	10.24	0.63
K08-TD	17.99	19.61	10.59	3.23	7.56	18.82	17.64	3"NPT	7.36	3.05	0.51	11.81	13.78	25.55	15.43	0.98	5.39	0.20	M8	12.20	18.94	12.56	10.24	0.63
K09-TD	19.37	22.09	12.4	3.78	8.86	20.0	18.82	4"NPT	8.66	3.58	0.51	11.81	13.78	29.33	17.91	0.98	7.83	0.20	M8	14.17	21.89	14.65	11.89	0.63
K10-TD	20.31	22.56	12.4	3.78	8.86	20.0	8.82	4"NPT	8.66	3.58	0.51	11.81	13.78	29.33	17.91	0.98	7.83	0.20	M8	14.17	21.89	14.65	11.89	0.63
K11 -TD	21.26	23.70	13.07	3.54	9.13	21.18	20.0	4"NPT	9.53	3.94	0.51	11.81	13.78	30.12	18.50	0.98	8.03	0.20	M8	15.35	21.89	15.24	12.76	0.63
K12-TD	21.57	23.81	13.07	3.54	9.13	21.18	20.0	4"NPT	9.53	3.94	0.51	11.81	13.78	30.23	18.50	0.98	8.03	0.20	M8	15.35	21.89	15.24	12.76	0.63

Model	Maximum flow cfm		Installed power Hp		Maximum differential pressure Δp (In Hg)		Noise level Lp dB (A) (1)		Overall dimensions H Inches	Weight Lbs
	60 Hz 3500 rpm	50 Hz 2900 rpm	60 Hz 3500 rpm	50 Hz 2900 rpm	60 Hz 3500 rpm	50 Hz 2900 rpm	60 Hz 3500 rpm	50 Hz 2900 rpm		
	K07-TD	296	245	15	15	12.6	11.8	79.5	77.5	24.5
K08-TD	368	305	15	15	12.6	12.6	79.9	77.9	24.5	248.5
K09-TD	467	387	25	-	14.0	13.3	82.8	-	30.0	406.0
K10-TD	571	473	25	25	13.3	13.3	86.5	84.5	30.0	412.0
K11-TD	642	532	25	25	9.6	12.6	87.2	85.2	30.5	442.0
K12-TD	716	593	30	30	8.9	12.6	88.0	86.0	31.0	443.0

(1) Noise measured at 1 m distance with inlet and outlet ports piped, in accordance to ISO 3744.

- For proper use, the blower should be equipped with inlet filter and safety valve; other accessories available on request.
- Ambient temperature from +5° to +104°F.
- Specifications subject to change without notice.



SCL K07 / K08 / K09 / K10 / K11 / K12
TD SERIES
SN 1834-12B 2/2

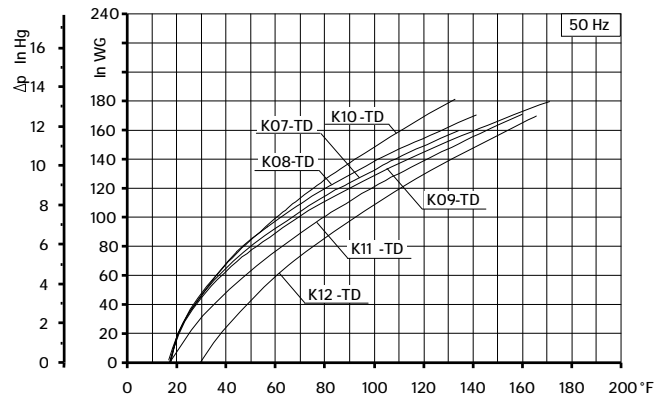
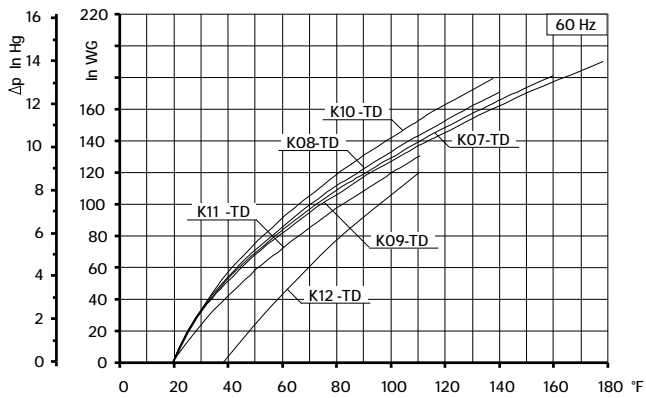
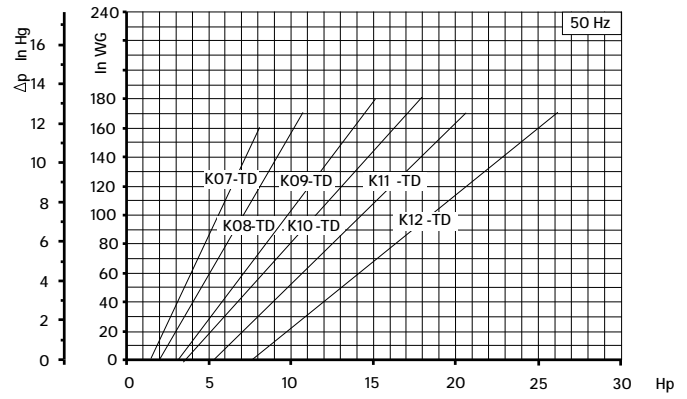
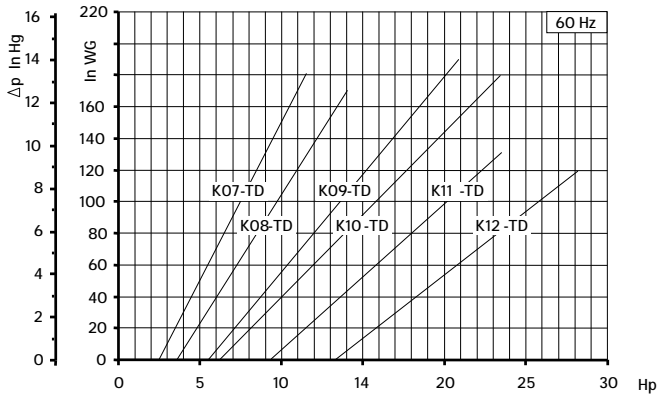
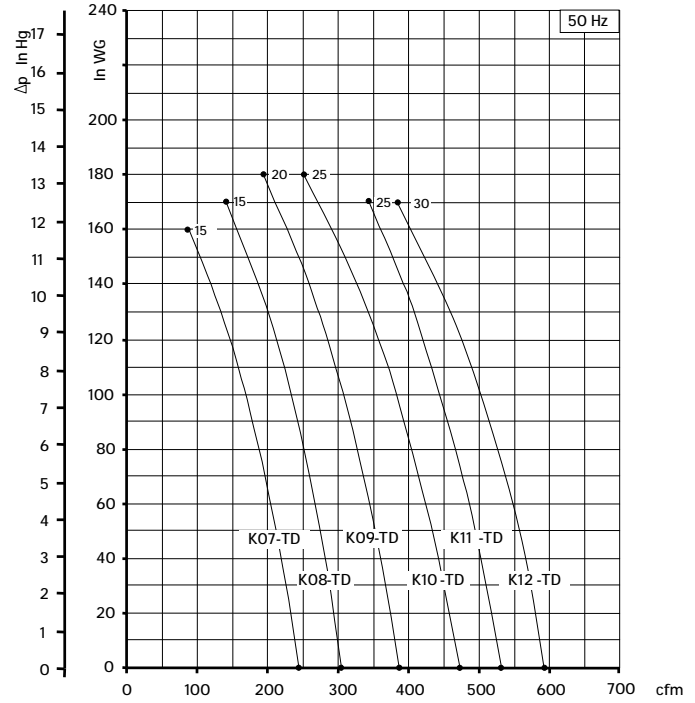
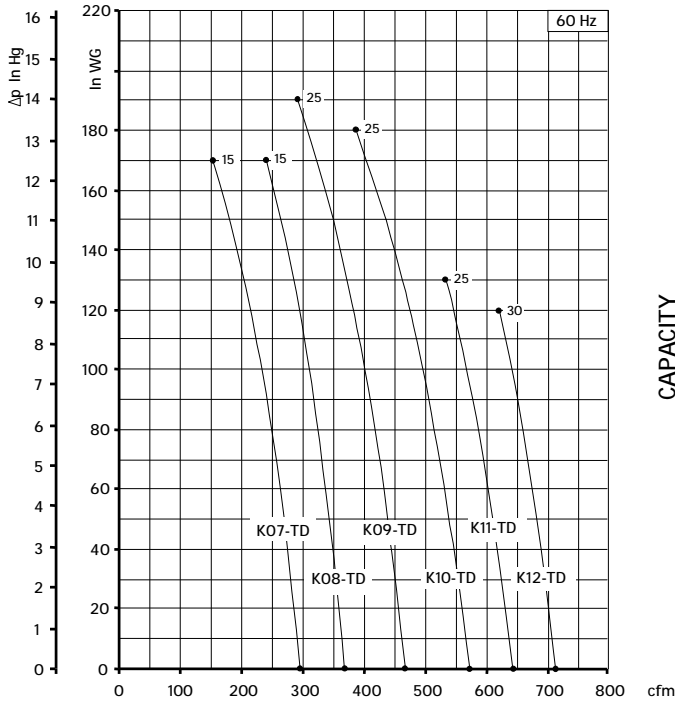

Curves refer to air at 68°F temperature, measured at inlet port and 29.92 In Hg atmospheric backpressure (abs).
Values for flow, power consumption and temperature rise +/-10% tolerance.
Data subject to change without notice.



STANDARD FEATURES

- Low weight cast aluminum construction.
- Quiet operation with integral inlet and outlet muffling.
- Recognized TEFC - cURus motor.
- High efficiency / low noise impeller design.
- No lubrication / maintenance required.
- Allowed ambient: +5 °F to +104 °F.
- Mountable in any plane.

OPTIONS

- Special voltages.
- Surface treatment or plating.
- Gas tight sealing.
- Special designs available.

ACCESSORIES

- Inlet and/or inline filters.
- Additional inlet/outlet silencers.
- Safety valves.
- Flow converting devices.
- Optional connectors

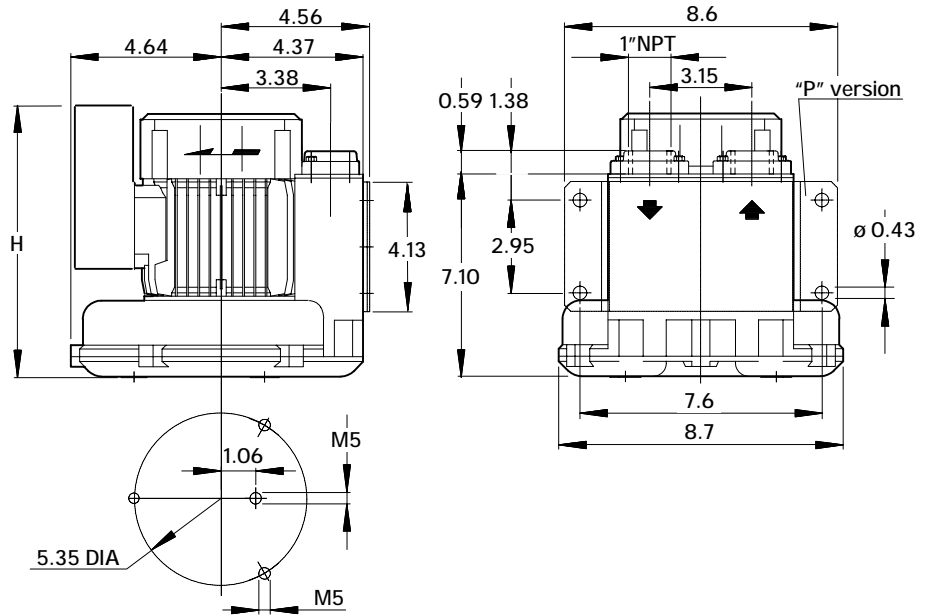

Dimensions in inches.
Dimension for reference only.

Model	Maximum flow cfm		Installed power Hp		Maximum differential pressure Δp (In Hg)		Noise level Lp dB (A) (1)		Overall dimensions H Inches	Weight Lbs
	60 Hz 3500 rpm	50 Hz 2900 rpm	60 Hz 3500 rpm	50 Hz 2900 rpm	60 Hz 3500 rpm	50 Hz 2900 rpm	60 Hz 3500 rpm	50 Hz 2900 rpm		
06	39	32	1/3	-	2.7	-	58.7	-	10.60	18.30
			1/2	1/2	3.5	2.4	59.0	58.0	10.60	18.50

(1) Noise measured at 1 m distance with inlet and outlet ports piped, in accordance to ISO 3744.

- For proper use, the blower should be equipped with inlet filter and safety valve; other accessories available on request.
- Ambient temperature from +5° to +104°F.
- Specifications subject to change without notice.



SCL 06

06 SERIES
SN 2674-2 2/2

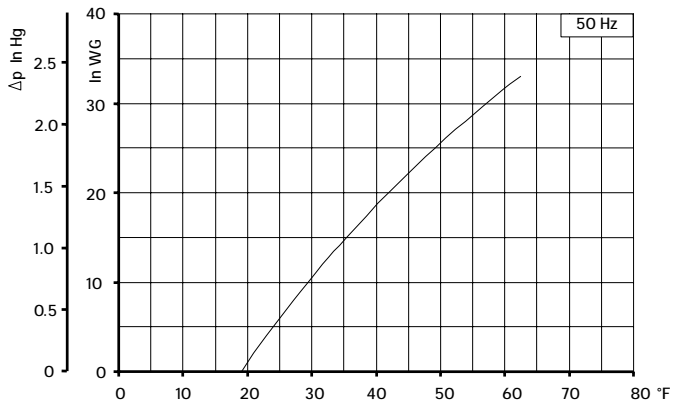
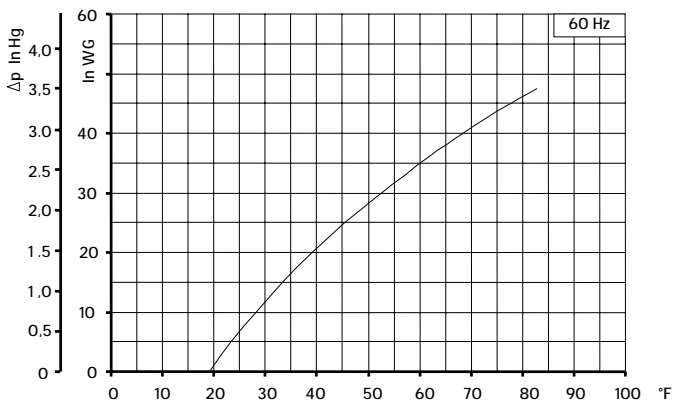
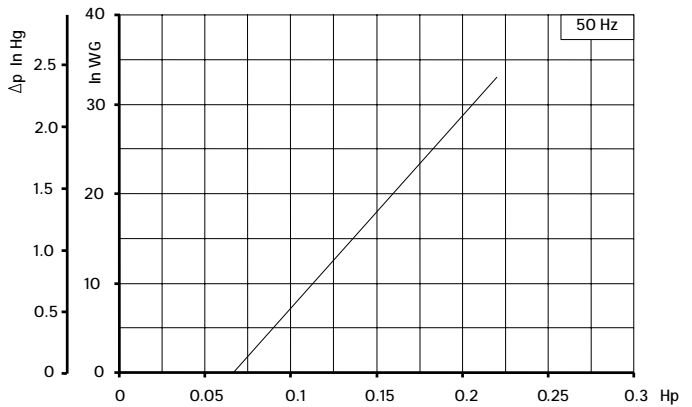
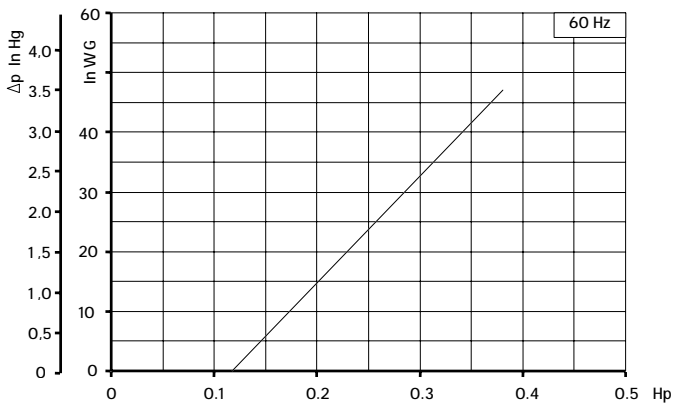
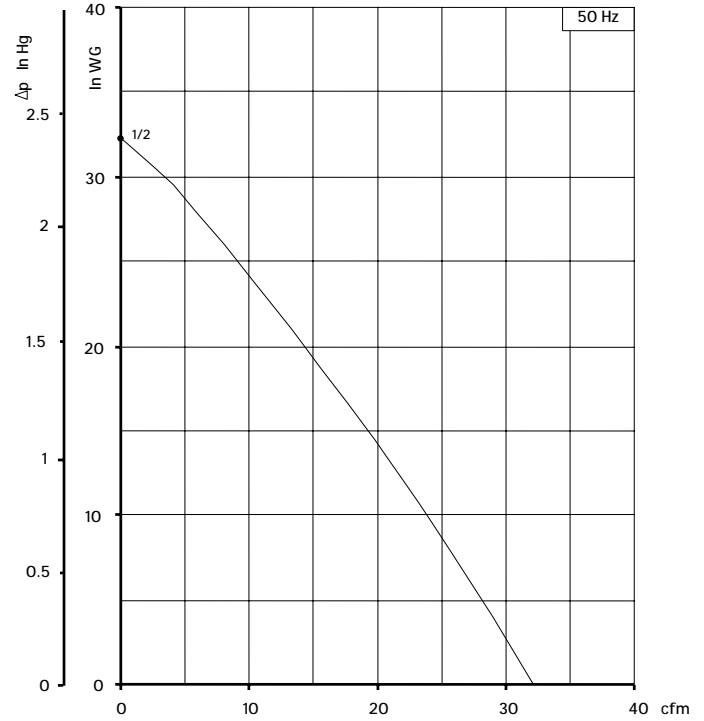
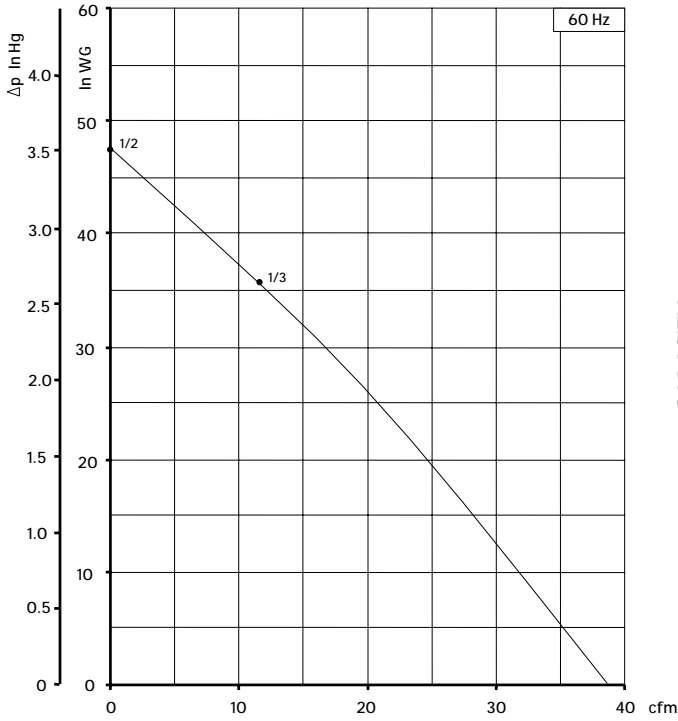

Curves refer to air at 68° F temperature, measured at inlet port and 29.92 In Hg atmospheric backpressure (abs).
 Values for flow, power consumption and temperature rise: +/-10% tolerance.
 Data subject to change without notice.



STANDARD FEATURES

- Low weight cast aluminum construction.
- Quiet operation with integral inlet and outlet muffling.
- Recognized TEFC - cURus motor.
- High efficiency / low noise impeller design.
- No lubrication / maintenance required.
- Allowed ambient: +5 °F to +104 °F.
- Mountable in any plane.

OPTIONS

- Remote drive models (belt or coupling).
- Special voltages.
- Surface treatment or plating.
- Gas tight sealing.
- Special designs available.

ACCESSORIES

- Inlet and/or inline filters.
- Additional inlet/outlet silencers.
- Safety valves.
- Flow converting devices.
- Optionals connectors

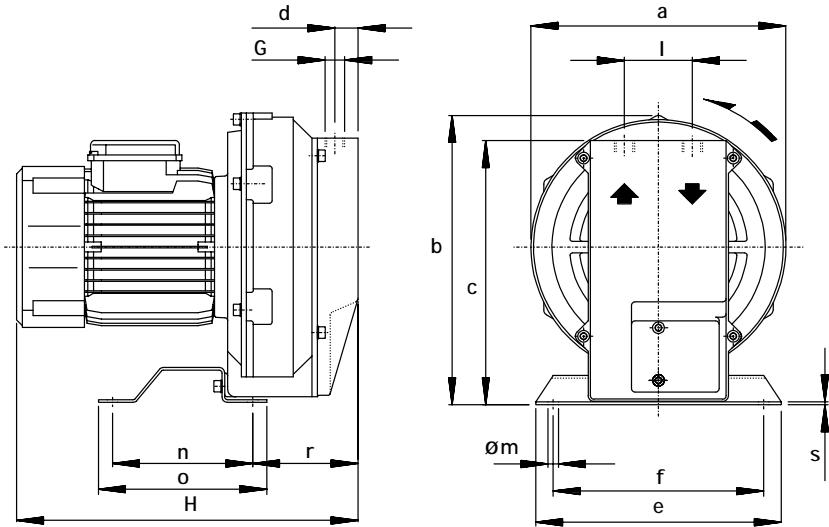

Dimensions in inches.
Dimension for reference only.

Model	a	b	c	d	e	f	G	l	m	n	o	r	s
10DL-MD	8.66	10.08	9.06	0.91	8.27	7.09	1/2" NPT	2.28	0.35	4.72	5.67	3.54	0.10
15DH-MD	9.84	11.26	0.16	1.18	8.27	7.09	3/4" NPT	2.52	0.35	4.72	5.67	4.72	0.10

Model	Maximum flow cfm		Installed power Hp		Maximum differential pressure Δp (In Hg)		Noise level Lp dB (A) (1)		Overall dimensions H Inches	Weight Lbs
	60 Hz 3500 rpm	50 Hz 2900 rpm	60 Hz 3500 rpm	50 Hz 2900 rpm	60 Hz 3500 rpm	50 Hz 2900 rpm	60 Hz 3500 rpm	50 Hz 2900 rpm		
10DL-MD	21	18	1/2	1/2	6.3	4.9	64.0	62.0	12.76	23.50
15DH-MD	35	29	3/4	3/4	7.2	7.7	63.7	61.7	14.25	32.50
			1	1	8.1	8.1	64.0	62.0	15.75	40.00

(1) Noise measured at 1 m distance with inlet and outlet ports piped, in accordance to ISO 3744.

- For proper use, the blower should be equipped with inlet filter and safety valve; other accessories available on request.
- Ambient temperature from +5° to +104°F.
- Specifications subject to change without notice.



SCL 10DL / 15DH
MD SERIES
SN 2198-5B 2/2

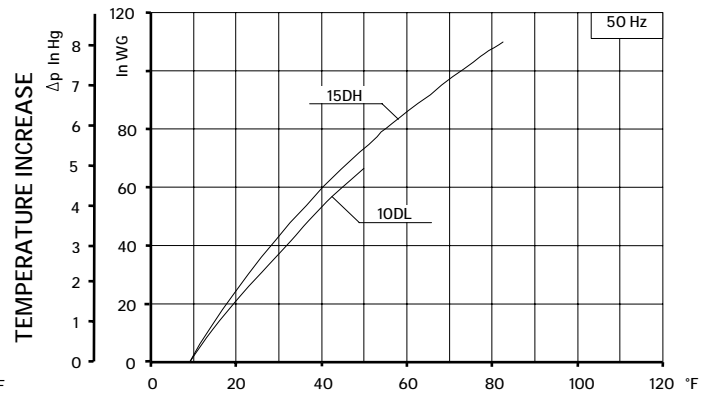
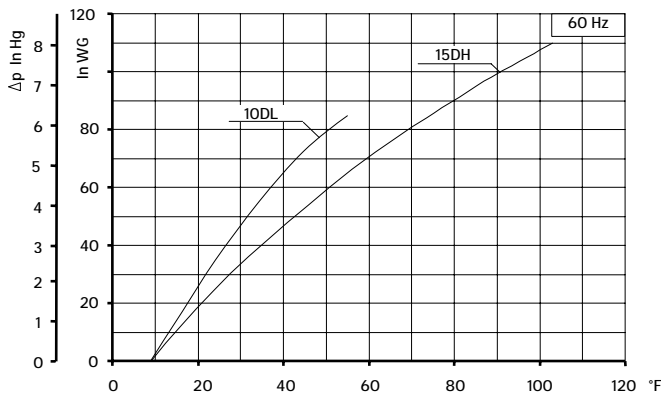
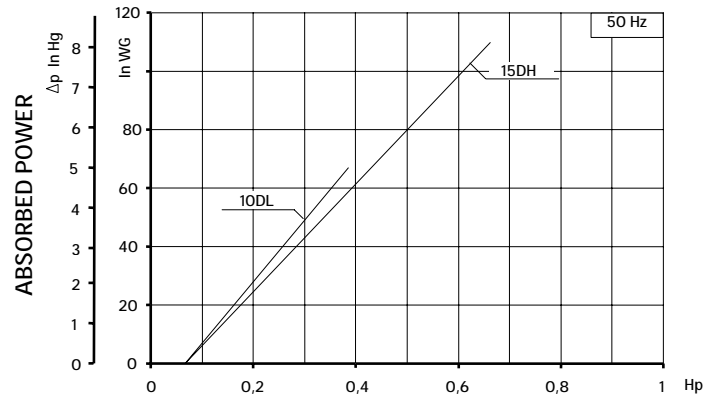
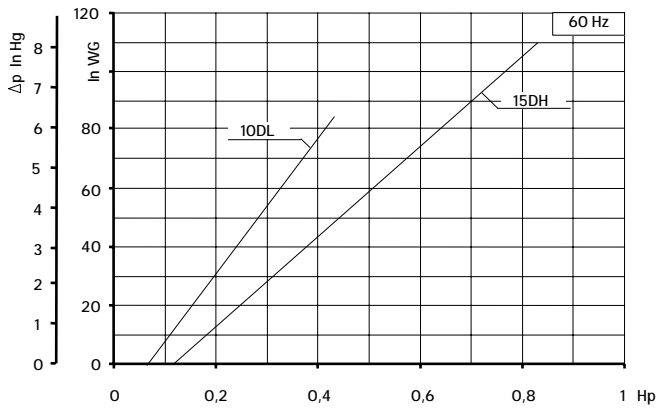
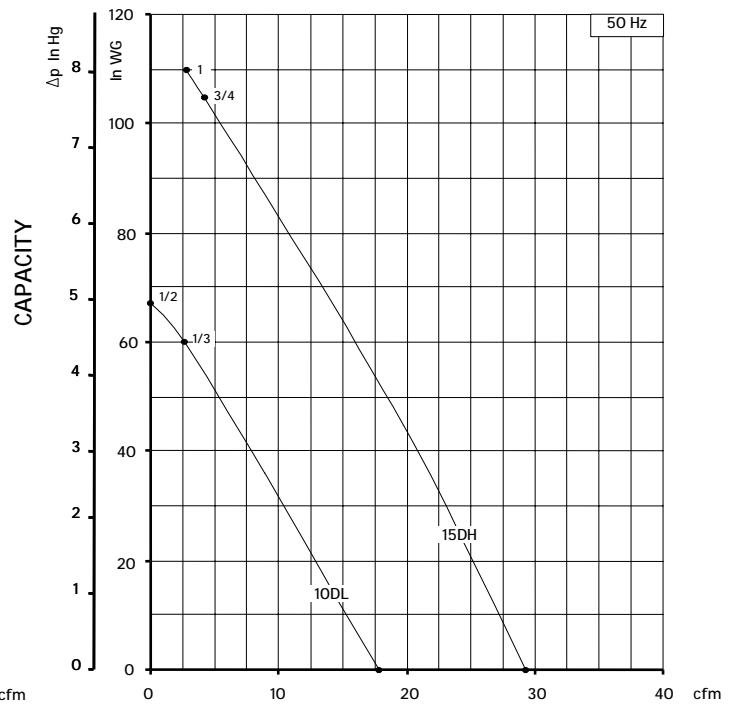
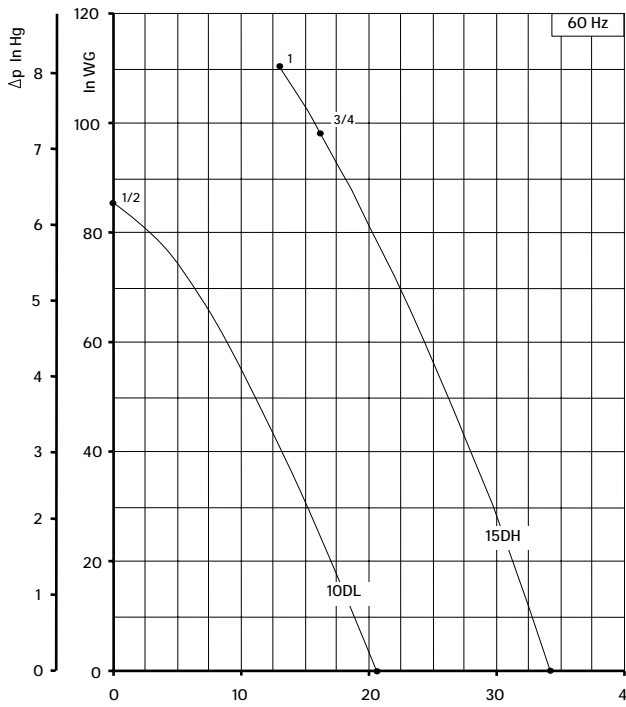

Curves refer to air at 68° F temperature, measured at inlet port and 29.92 In Hg atmospheric backpressure (abs).
Values for flow, power consumption and temperature rise: +/-10% tolerance.
Data subject to change without notice.



STANDARD FEATURES

- Low weight cast aluminum construction.
- Quiet operation with integral inlet and outlet muffling.
- Recognized TEFC - cURus motor.
- High efficiency / low noise impeller design.
- No lubrication / maintenance required.
- Allowed ambient: +5 °F to +104 °F.
- Mountable in any plane.

OPTIONS

- Remote drive models (belt or coupling).
- Special voltages.
- Surface treatment or plating.
- Gas tight sealing.
- Special designs available.

ACCESSORIES

- Inlet and/or inline filters.
- Additional inlet/outlet silencers.
- Relief valves.
- Flow converting devices.
- Optionals connectors

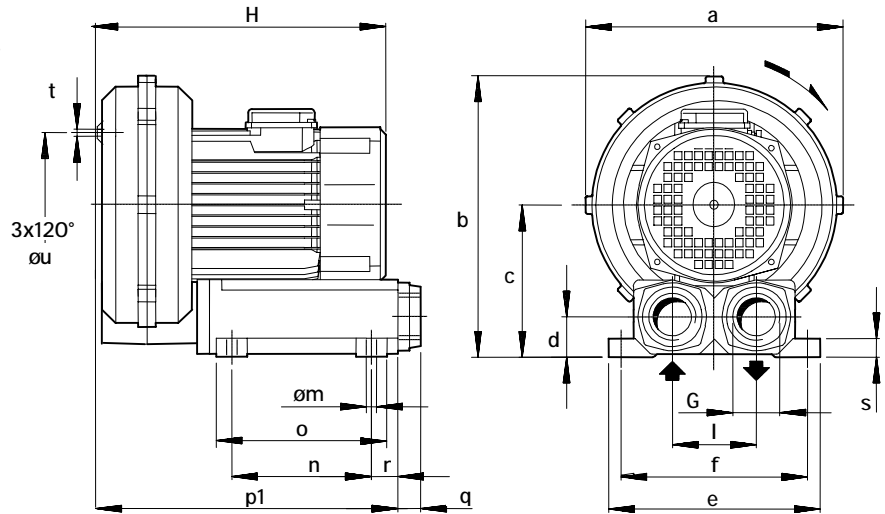

Dimensions in inches.

Dimension for reference only.

Model	a	b	c	d	e	f	G	I	m	n	o	p1	q	r	s	t	u
R20-MD	11.14	12.17	6.57	1.85	9.25	8.27	1" ¼ NPT	3.54	0.39	5.91	7.87	13.58	0.71	1.77	0.87	M6	5.91
R30-MD	12.56	13.62	7.36	1.85	9.25	8.27	1" ¼ NPT	3.54	0.39	5.91	7.87	13.94	0.71	1.77	0.87	M6	7.09
R40-MD	13.78	14.65	7.76	1.85	9.25	8.27	1" ¼ NPT	3.54	0.39	5.91	7.87	14.33	0.71	1.77	0.87	M8	8.86

Model	Maximum flow Scfm		Installed power Hp		Maximum differential pressure Δp (In Hg)		Noise level Lp dB (A) (1)		Overall dimensions H Inches	Weight Lbs
	60 Hz 3500 rpm	50 Hz 2900 rpm	60 Hz 3500 rpm	50 Hz 2900 rpm	60 Hz 3500 rpm	50 Hz 2900 rpm	60 Hz 3500 rpm	50 Hz 2900 rpm		
R20-MD	41	35	1 ½	1 ½	10.3	8.9	68.5	66.5	13.39	48.5
R30-MD	65	54	2	2	11.1	10.3	72.2	69.2	15.58	57.3
R40-MD	81	69	3	3	11.1	10.3	72.8	70.8	16.22	77.2

(1) Noise measured at 1 m distance with inlet and outlet ports piped, in accordance to ISO 3744.

- For proper use, the blower should be equipped with inlet filter and relief valve; other accessories available on request.
- Ambient temperature from +5° to +104°F.
- Specifications subject to change without notice.



SCL R20 / R30 / R40

MD SERIES

SN 2465-4B 2/2

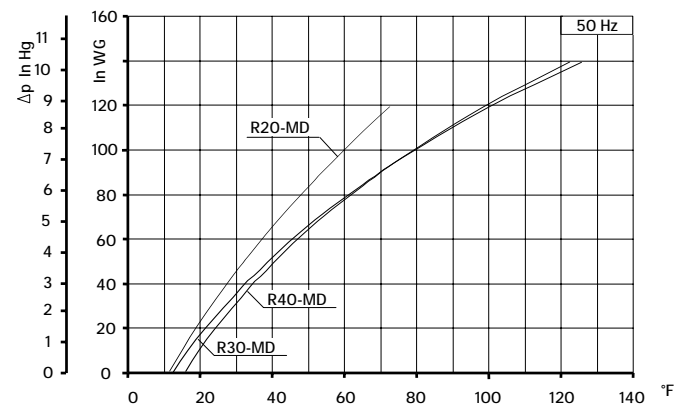
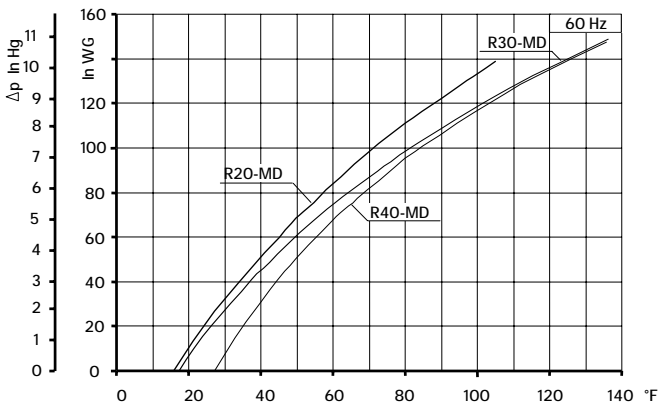
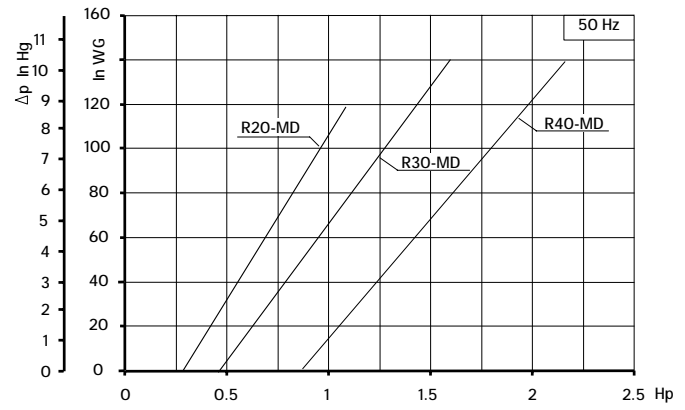
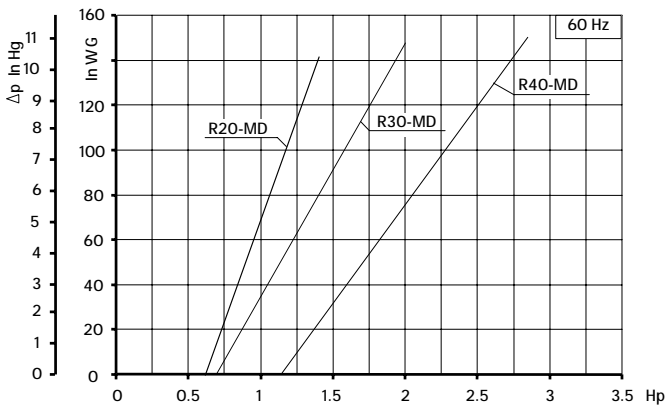
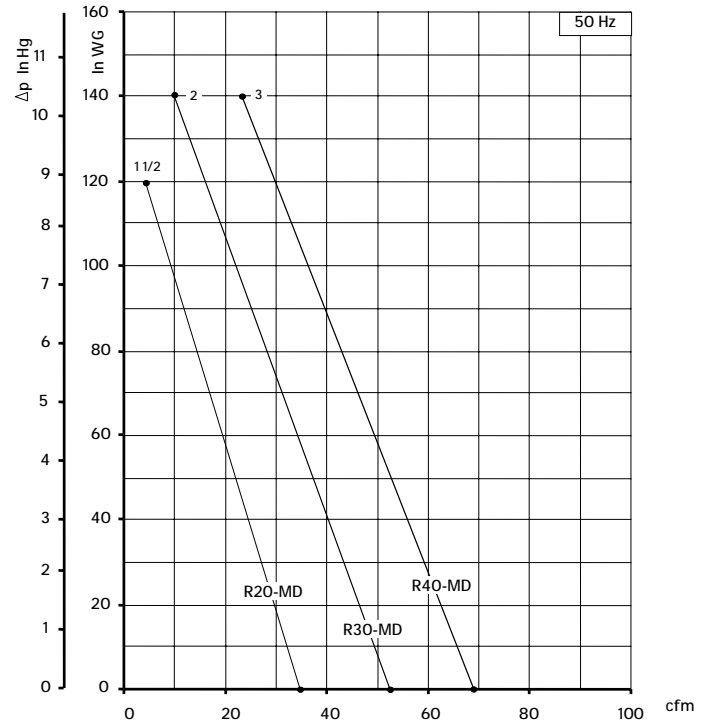
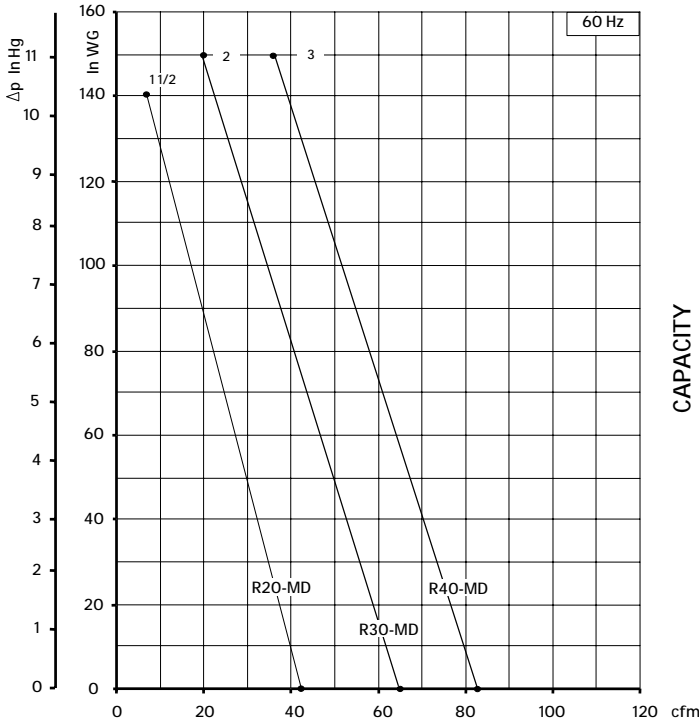

Curves refer to air at 68° F temperature, measured at inlet port and 29.92 In Hg atmospheric backpressure (abs).
 Values for flow, power consumption and temperature rise: +/-10% tolerance.
 Data subject to change without notice.



SCL K03 / K04 / K05 / K06

MS SERIES - GOR/GVR RANGE

SN 2582-2 1/2

TECHNICAL CHARACTERISTICS

- Aluminium alloy construction
- Smooth operation
- High efficiency impeller
- Maintenance free
- Mountable in any position

OPTIONS

- Special voltages (IEC 38)
- Surface treatments

ACCESSORIES

- Inlet and/or inline filters
- Additional inlet/outlet silencers
- Safety valves
- Flow converting device
- Optional connectors

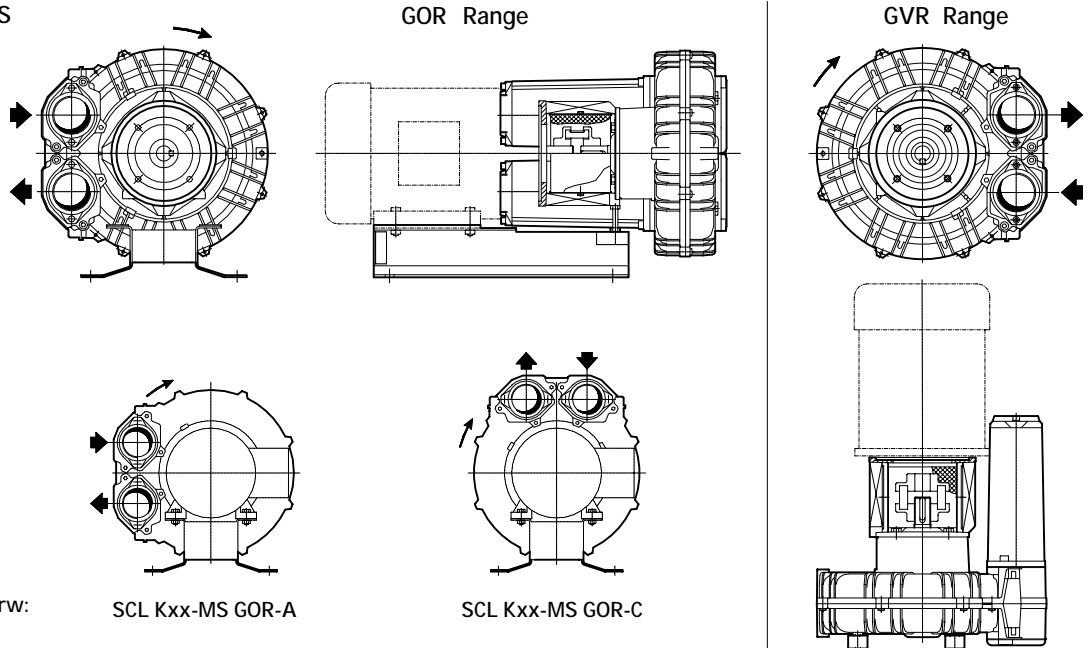

For dimensions, please refer to drw:

- GOR range: SI 1852

- GVR range: SI 1946

SCL Kxx-MS GOR-A

SCL Kxx-MS GOR-C

Model	Maximum flow cfm		Installed power Hp	Size	Maximum differential pressure Δp (in Hg)		Noise level Lp dB (A) (1)		Weight (2)		
	60 Hz 3500 rpm	50 Hz 2900 rpm			60 Hz 3500 rpm	50 Hz 2900 rpm	60 Hz 3500 rpm	50 Hz 2900 rpm	Lbs GOR	Lbs GVR	
K03-MS	52	43	3/4	NEMA 56C	4.7	3.7	61.0	59.0	22.00	17.60	
K04-MS	98	81	1 1/2	NEMA 56C	4.3	5.9	63.8	61.8	27.60	22.00	
			2	NEMA 56C	6.3		64.0				
			3	NEMA 56C	6.6		64.2				
K05-MS	156	129	2	NEMA 143-5TC	3.8	5.2	69.5	67.5	35.00	28.00	
			3	NEMA 143-5TC	6.6		69.8				
			5	NEMA 182-4TC	8.1		70.4				
K06-MS	216	179	3	NEMA 143-5TC	3.7	4.8	72.0	70.0	46.00	38.40	
			5	NEMA 182-4TC			6.3				72.6
			7 1/2	NEMA 182-4TC			9.6				72.9

(1) Noise measured at 1 m distance with inlet and outlet ports piped, in accordance to ISO 3744.

(2) Value is referred to weight of the machine without electric motor.

- For proper use, the blower should be equipped with inlet filter and safety valve; other accessories available on request.

- Ambient temperature from +5° to +104°F.

- Specifications subject to change without notice.



SCL K03 / K04 / K05 / K06
MS SERIES - GOR/GVR RANGE
SN 2582-2 2/2

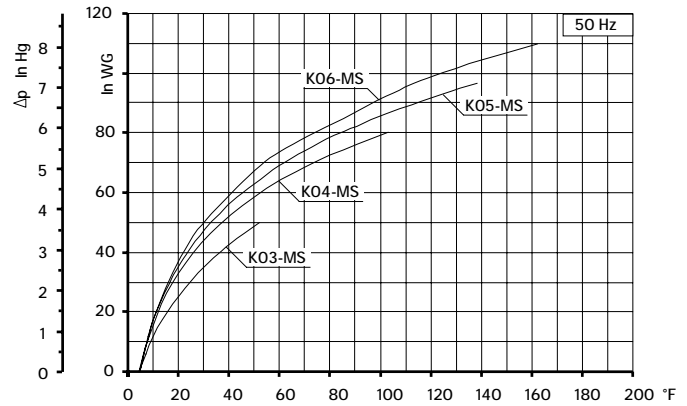
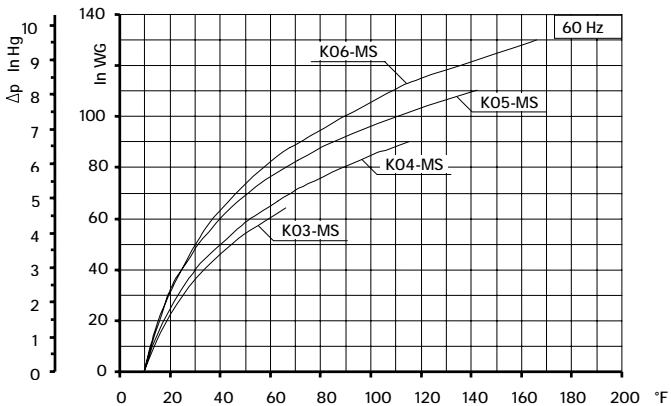
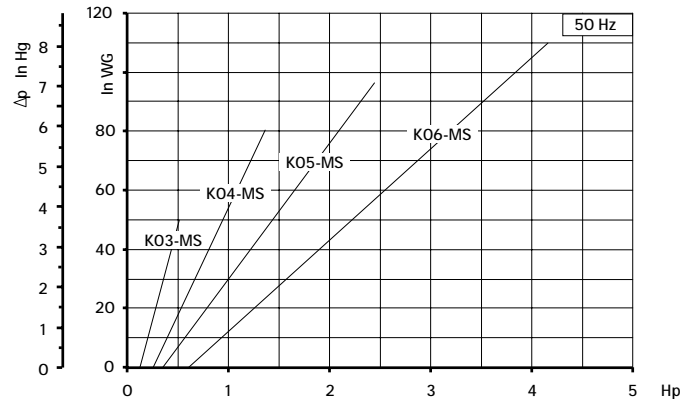
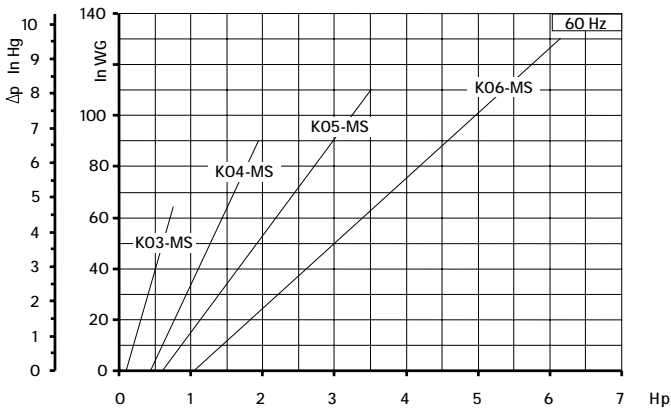
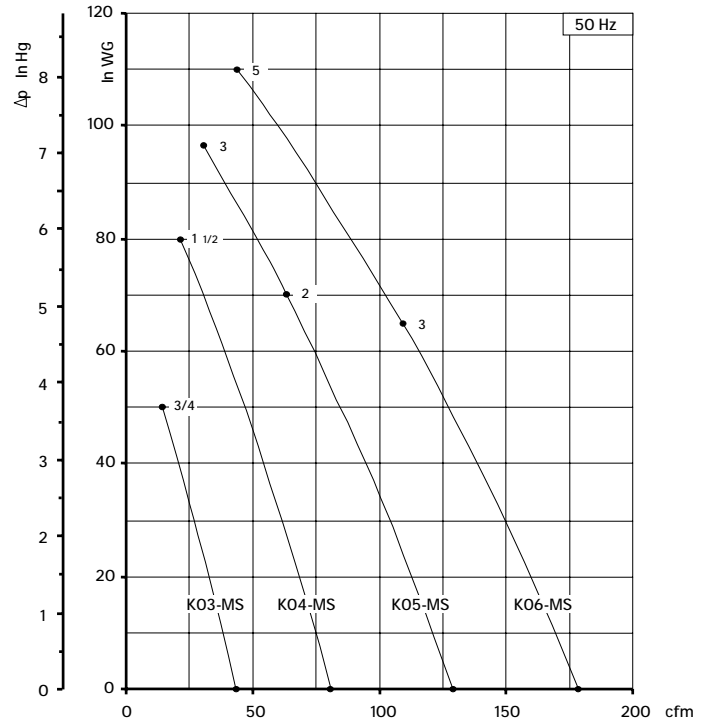
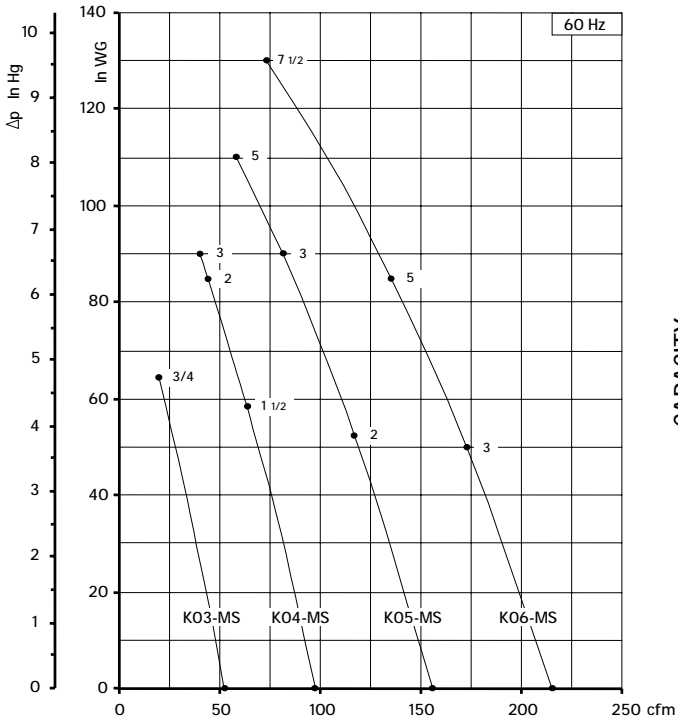

Curves refer to air at 68° F temperature, measured at inlet port and 29.92 In Hg atmospheric backpressure (abs).
Values for flow, power consumption and temperature rise: +/-10% tolerance.
Data subject to change without notice.

SCL K07 / K08 / K09 / K10 / K11 / K12
MS SERIES - GOR/GVR RANGE
SN 2135-4 1/2

TECHNICAL CHARACTERISTICS

- Aluminium alloy construction
- Smooth operation
- High efficiency impeller
- Maintenance free
- Mountable in any position

OPTIONS

- Special voltages (IEC 38)
- Surface treatments

ACCESSORIES

- Inlet and/or inline filters
- Additional inlet/outlet silencers
- Safety valves
- Flow converting device
- Optional connectors

For dimensions, please refer to drw:

GOR range: SI 1873

GVR range: SI 1920

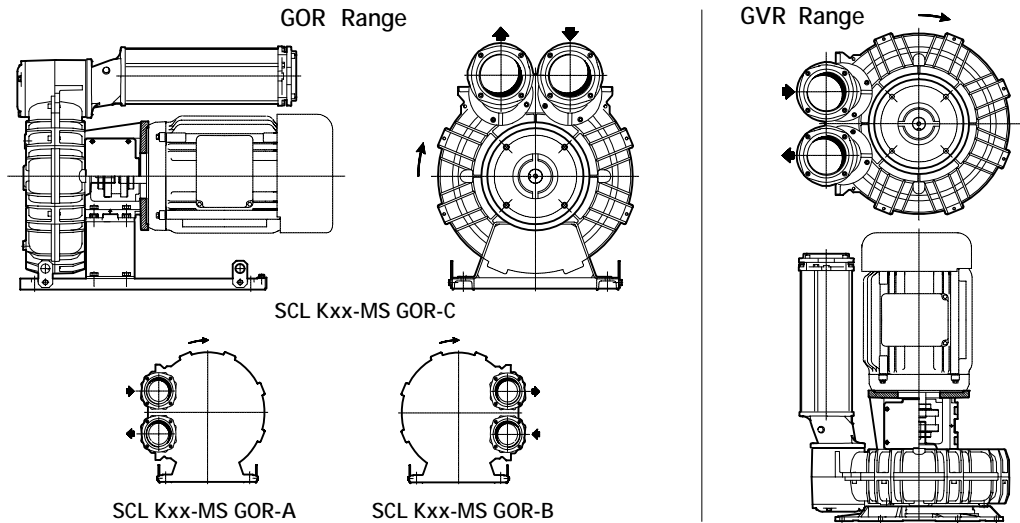

Model	Maximum flow cfm		Installed power Hp	Size	Maximum differential pressure Δp (in Hg)		Noise level Lp dB (A) (1)		Weight (2) Lbs
	60 Hz 3500 rpm	50 Hz 2900 rpm			60 Hz 3500 rpm	50 Hz 2900 rpm	60 Hz 3500 rpm	50 Hz 2900 rpm	
K07-MS	294	243	5	NEMA 182-4TC	5.1	6.3	78.0	76.0	110.50
			7 1/2	NEMA 182-4TC	9.6	8.8	78.3	76.3	110.50
				NEMA 213-5TC					110.50
K08-MS	381	316	5	NEMA 182-4TC	2.8	3.8	78.8	76.8	127.00
			7 1/2	NEMA 182-4TC	5.0	6.6	79.1	77.1	127.00
				NEMA 213-5TC					127.00
			10	NEMA 213-5TC	8.5	9.2	79.4	77.4	127.00
			15	NEMA 213-5TC	10.3		79.7		127.00
NEMA 254-6TC		130.60							
K09-MS	471	390	7 1/2	NEMA 182-4TC	3.7	4.6	79.3	77.3	133.40
				NEMA 213-5TC					133.40
			10	NEMA 213-5TC	5.9	7.0	79.6	77.6	133.40
			15	NEMA 213-5TC	10.3	80.1	78.1	133.40	
NEMA 254-6TC	80.4	137.00							
K10-MS	556	460	7 1/2	NEMA 182-4TC	2.2	3.7	79.4	77.4	147.30
				NEMA 213-5TC					147.30
			10	NEMA 213-5TC	4.4	5.9	79.7	77.7	147.30
			15	NEMA 213-5TC	8.1	9.6	80.2	78.2	147.30
				NEMA 254-6TC					151.00
20	NEMA 254-6TC	10.3		80.5	151.00				
K11-MS	650	539	10	NEMA 213-5TC	2.9	3.9	82.0	80.0	170.00
			15	NEMA 213-5TC	5.9	7.1	82.5	80.5	170.00
				NEMA 254-6TC					176.40
			20	NEMA 254-6TC	9.2	9.6	83.0	81.0	176.40
25	NEMA 284-6TSC	10.3	83.8	170.00					
K12-MS	726	602	15	NEMA 213-5TC	3.8	6.6	83.5	81.5	177.70
				NEMA 254-6TC					184.10
			20	NEMA 254-6TSC	6.3	9.6	84.3	82.3	184.10
			25	NEMA 284-6TSC	8.8		87.2		177.70
			30	NEMA 284-6TSC	10.3		87.6		177.70

(1) Noise measured at 1 m distance with inlet and outlet ports piped, in accordance to ISO 3744.

(2) Value is referred to weight of the machine without electric motor

- For proper use, the blower should be equipped with inlet filter and safety valve; other accessories available on request.
- Ambient temperature from +5° to +104°F.
- Specifications subject to change without notice.



SCL K07 / K08 / K09 / K10 / K11 / K12
MS SERIES - GOR/GVR RANGE

SN 2135-4 2/2

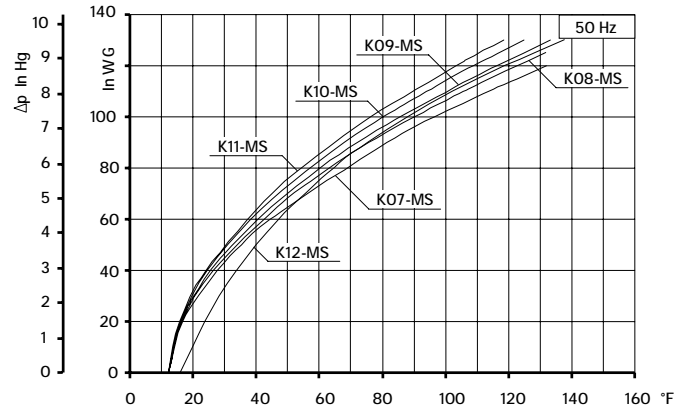
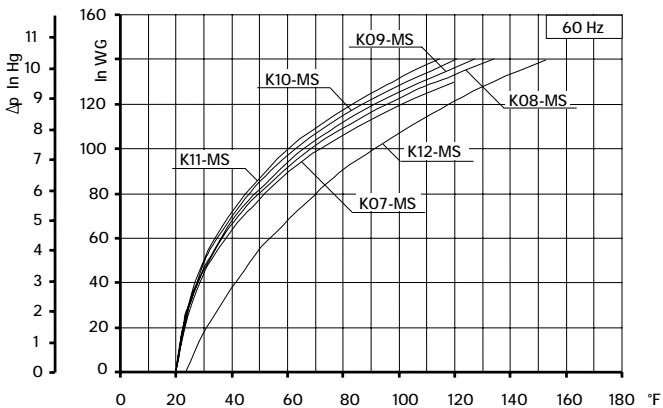
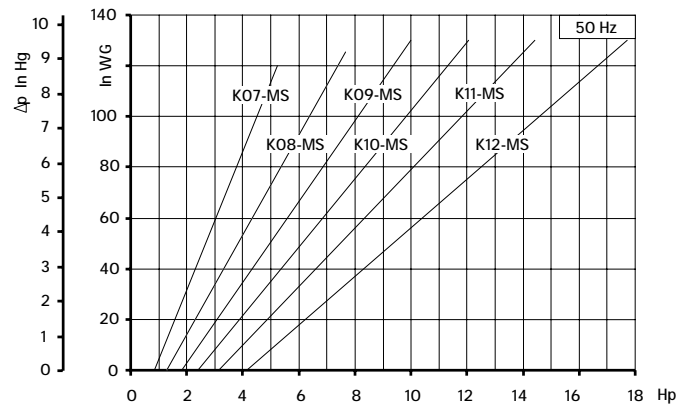
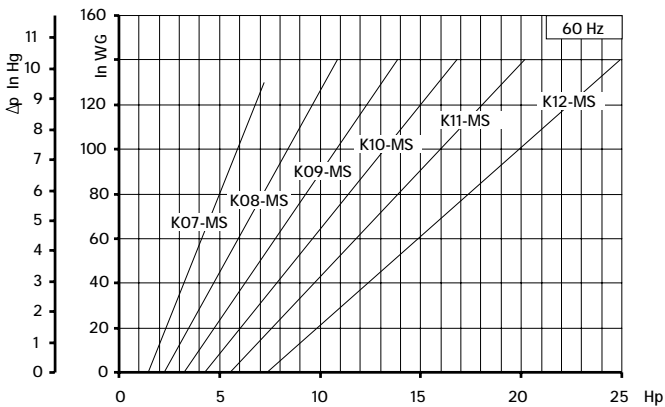
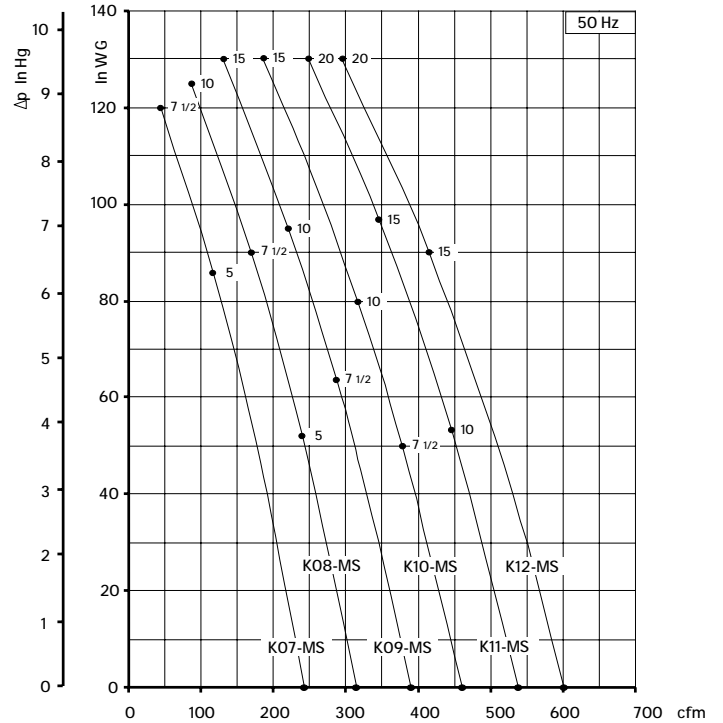
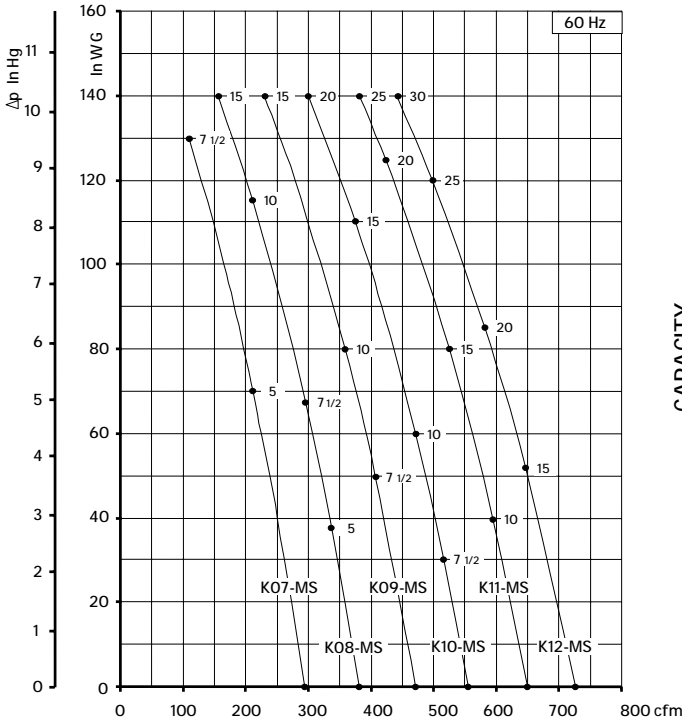

Curves refer to air at 68° F temperature, measured at inlet port and 29.92 In Hg atmospheric backpressure (abs).
Values for flow, power consumption and temperature rise: +/-10% tolerance.
Data subject to change without notice.

SCL K05 / K06

TS SERIES - GOR / GVR USA RANGE

SN 2688-2 1/2

TECHNICAL CHARACTERISTICS

- Aluminium alloy construction
- Smooth operation
- High efficiency impeller
- Maintenance free
- Mountable in any plane
- G1/8" female thread on both suction and discharge silencer port flanges.

OPTIONS

- Special voltages (IEC 38)
- Surface treatments

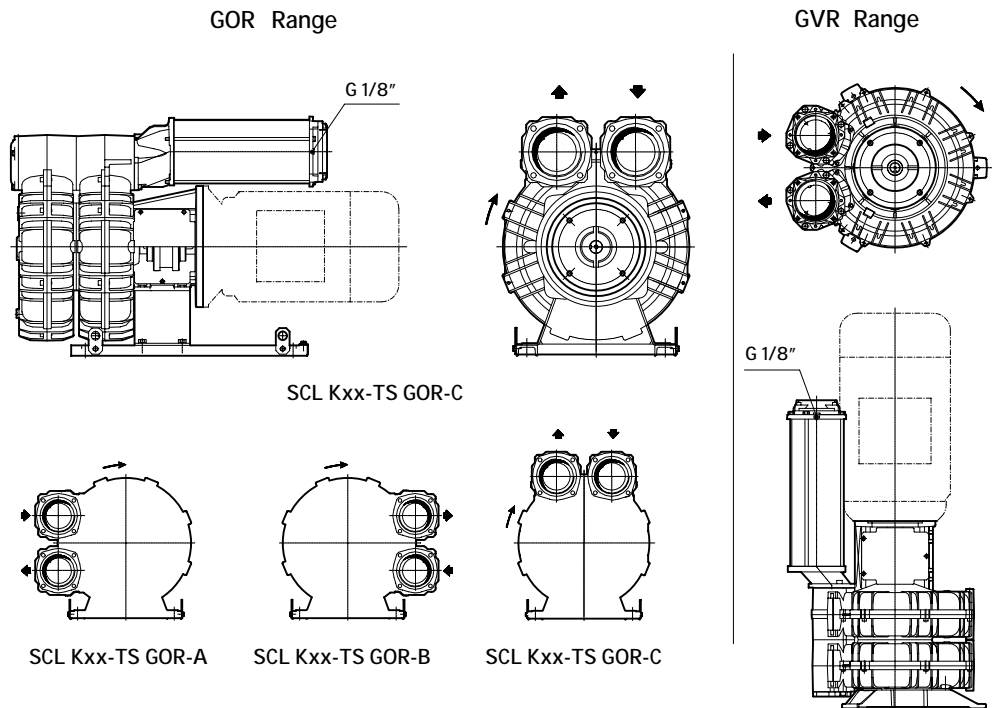

For dimensions, please refer to drw:

- GOR range: SI 21 23
- GVR range: SI 21 35

Model	Maximum flow m ³ /h		Installed power Hp	Size	Maximum differential pressure Δp (in Hg)		Noise level Lp dB (A) (1)		Weight (2)	
	60 Hz 3500 rpm	50 Hz 2900 rpm			60 Hz 3500 rpm	50 Hz 2900 rpm	60 Hz 3500 rpm	50 Hz 2900 rpm	Lbs	
									GOR	GVR
K05-TS	290	241	5.0	NEMA 182-4TC	4.4	6.3	75.1	73.1	72.75	68.35
			7.5		7.4	6.7	77.1	75.1		
K06-TS	400	331	7.5	NEMA 213-5TC	4.1	5.7	77.1	75.1	112.45	108.00
			10		5.9	7.4	77.4	75.4		
			15		7.8		78.0	76.0		

(1) Noise measured at 1 m distance with inlet and outlet ports piped, in accordance to ISO 3744.

(2) Value is referred to weight of the machine without electric motor.

- For proper use, the blower should be equipped with inlet filter and safety valve; other accessories available on request.
- Ambient temperature from +5° to +104°F.
- Specifications subject to change without notice.



SCL K05 / K06
TS SERIES - GOR/GVR RANGE
SN 2688-2 2/2

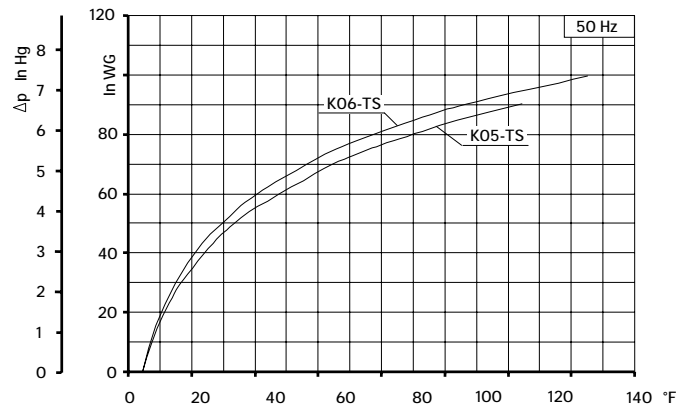
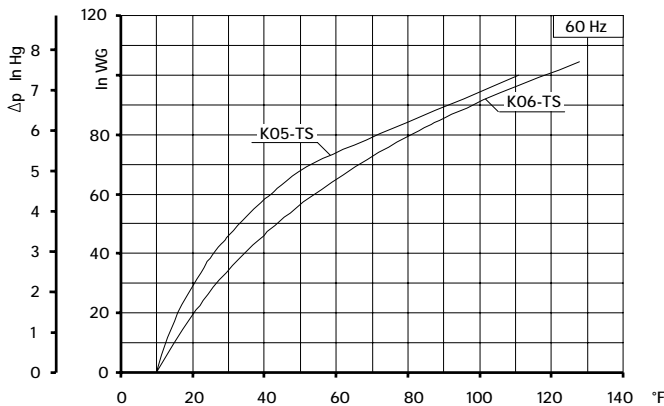
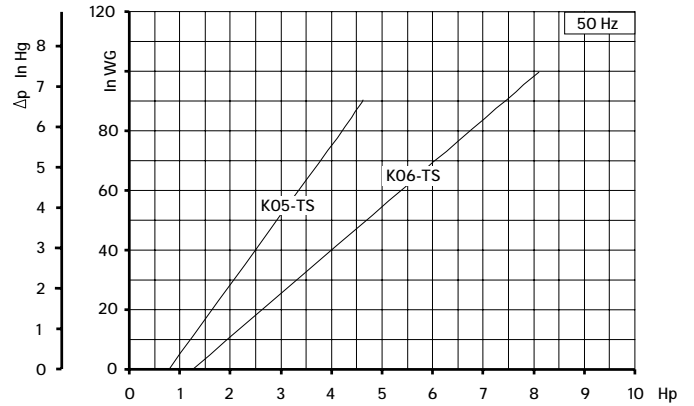
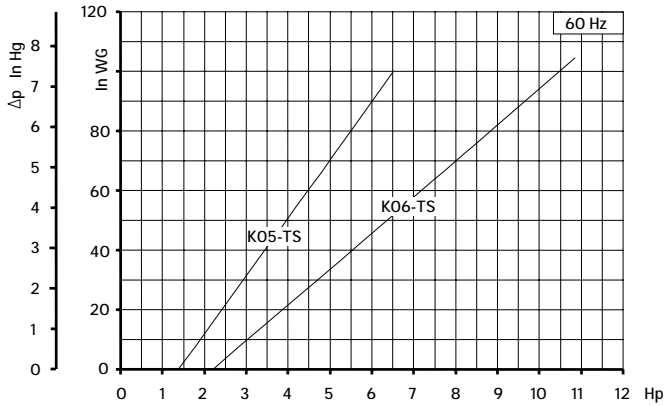
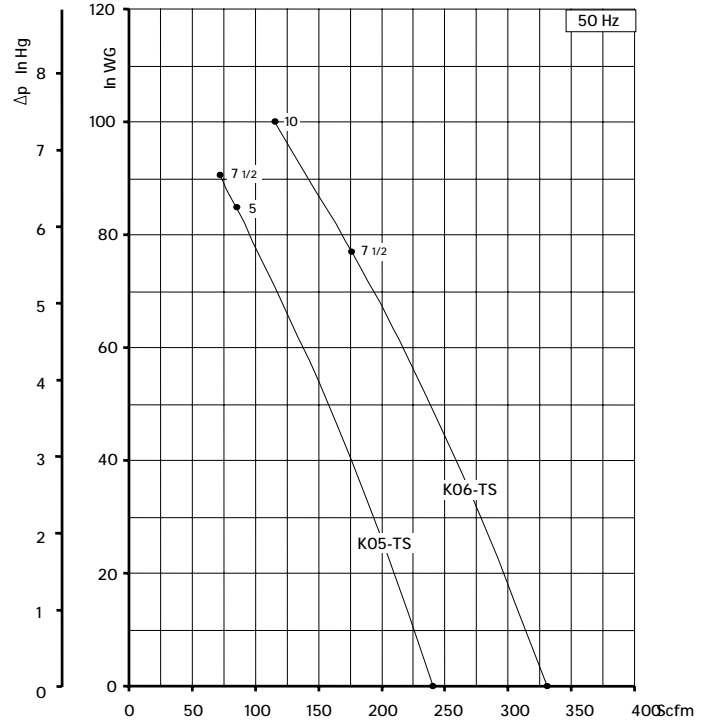
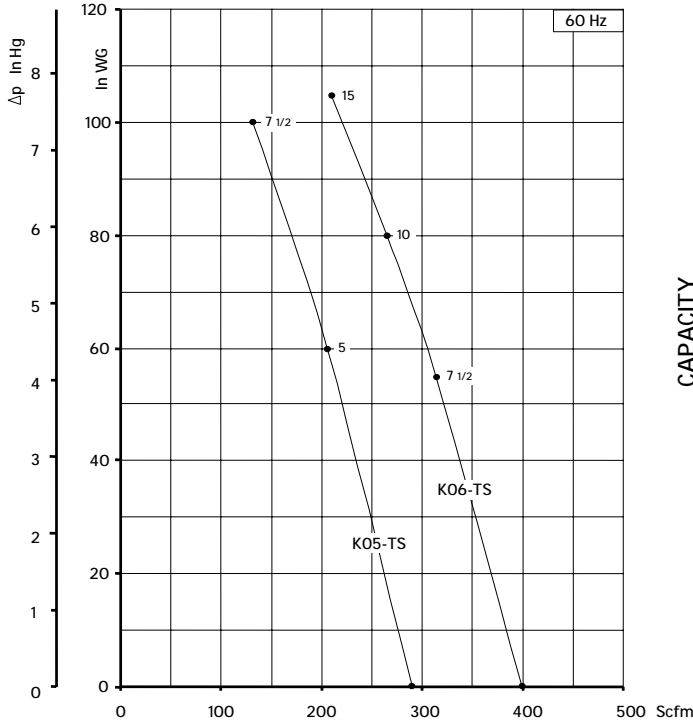

Curves refer to air at 20°C temperature, measured at inlet port and 1013 mbar (abs) atmospheric backpressure. Values for flow, power consumption and temperature rise: +/-10% tolerance. Data subject to change without notice.



SCL K07 / K08 / K09 / K10 / K11 / K12

TS SERIES - GOR/GVR RANGE

SN 2165-6 1/2

TECHNICAL CHARACTERISTICS

- Aluminium alloy construction
- Smooth operation
- High efficiency impeller
- Maintenance free
- Mountable in any position
- G1/8" female thread on both suction and discharge silencer port flanges

OPTIONS

- Special voltages (IEC 38)
- Surface treatments

ACCESSORIES

- Inlet and/or inline filters
- Additional inlet/outlet silencers
- Safety valves
- Flow converting device
- Optional connectors

For dimensions, please refer to drw:

GOR range: **SI 1879**

GVR range: **SI 1880**

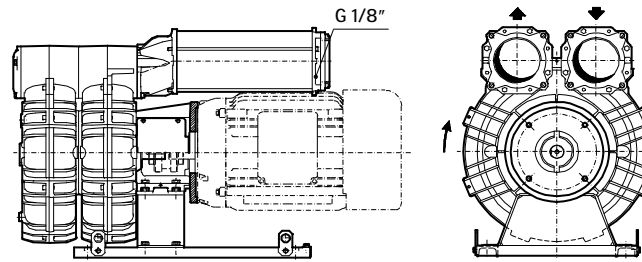
GOR RANGE

SCL Kxx-TS GOR-C

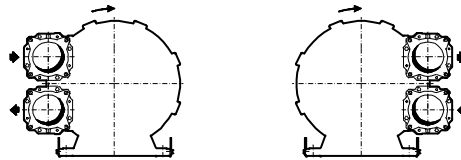

SCL Kxx-TS GOR-A

SCL Kxx-TS GOR-B

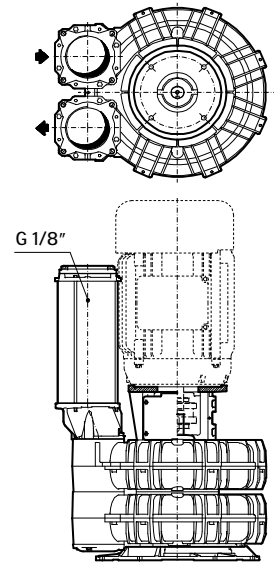
GVR RANGE

Model	Maximum flow cfm		Installed power Hp	Size	Maximum differential pressure Δp (In Hg)		Noise level Lp dB (A) (1)		Weight (2) Lbs
	60 Hz 3500 rpm	50 Hz 2900 rpm			60 Hz 3500 rpm	50 Hz 2900 rpm	60 Hz 3500 rpm	50 Hz 2900 rpm	
K07-TS	588	487	7 1/2	NEMA 182-4TC	2.6	4.4	84.5	82.5	160.90
				NEMA 213-5TC	2.6	4.4	84.5	82.5	160.90
			10	NEMA 213-5TC	4.4	6.6	84.8	82.8	160.90
			15	NEMA 213-5TC	8.1	8.1	85.4	83.4	160.90
				NEMA 254-6TC	8.1	8.1	85.4	83.4	167.60
20	NEMA 254-6TC	8.8	8.1	85.9	83.4	167.60			
K08-TS	715	592	10	NEMA 213-5TC	2.7	4.7	81.2	79.2	172.00
			15	NEMA 213-5TC	5.5	7.7	82.9	80.9	172.00
				NEMA 254-6TC	5.5	7.7	82.9	80.9	180.80
			20	NEMA 254-6TC	7.4	8.8	84.8	80.8	180.80
25	NEMA 284-6TSC	9.6	8.8	87.0	80.8	174.20			
K09-TS	941	780	15	NEMA 213-5TC	3.8	5.5	82.2	80.2	202.80
				NEMA 254-6TC	3.8	5.5	82.2	80.2	208.30
			20	NEMA 254-6TC	5.9	7.9	84.1	82.1	208.30
			25	NEMA 284-6TSC	8.1	8.8	86.1	84.1	205.00
			30	NEMA 284-6TSC	8.8	8.8	88.1	84.1	205.00
40	NEMA 324-6TSC	9.6	8.8	90.1	84.1	220.50			
K10-TS	1093	906	15	NEMA 213-5TC	3.0	4.7	89.1	87.1	209.40
				NEMA 254-6TC	3.0	4.7	89.1	87.1	216.10
			20	NEMA 254-6TC	4.8	6.6	89.4	87.4	216.10
			25	NEMA 284-6TSC	5.9	8.1	89.7	87.7	211.60
			30	NEMA 284-6TSC	7.4	9.6	90.0	88.0	211.60
40	NEMA 324-6TSC	10.3	9.6	90.3	88.0	227.10			
K11-TS	1254	1039	25	NEMA 284-6TSC	3.7	6.5	90.7	88.7	251.30
			30	NEMA 284-6TSC	5.1	8.1	91.3	89.3	251.30
			40	NEMA 324-6TSC	8.0	9.6	91.9	89.9	269.00
			50	NEMA 324-6TSC	10.3	9.6	92.5	89.9	269.00
K12-TS	1410	1168	30	NEMA 284-6TSC	3.3	5.9	91.9	89.9	249.10
			40	NEMA 324-6TSC	5.2	8.8	92.5	90.5	266.80
			50	NEMA 324-6TSC	8.1	-	93.1	-	266.80

(1) Noise measured at 1 m distance with inlet and outlet ports piped, in accordance to ISO 3744.

(2) Value is referred to weight of the machine without electric motor

- Specifications subject to change without notice.

- Ambient temperature from +5° to +104°F.

- For proper use, the blower should be equipped with inlet filter and safety valve; other accessories available on request.



SCL K07 / K08 / K09 / K10 / K11 / K12
 TS SERIES - GOR/GVR RANGE
 SN 2165-6 2/2

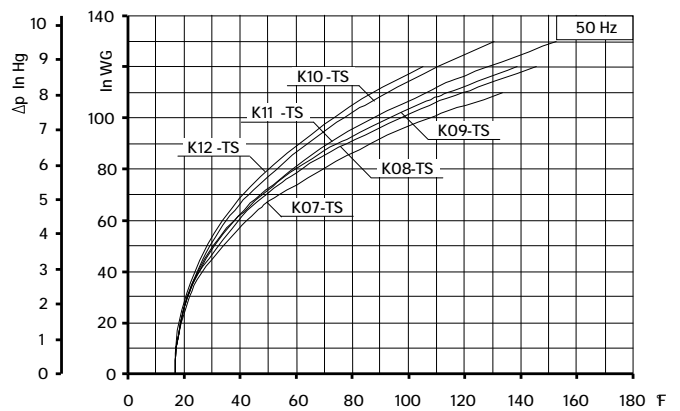
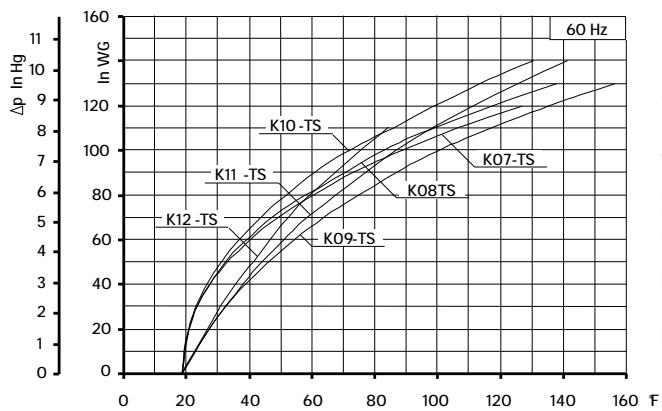
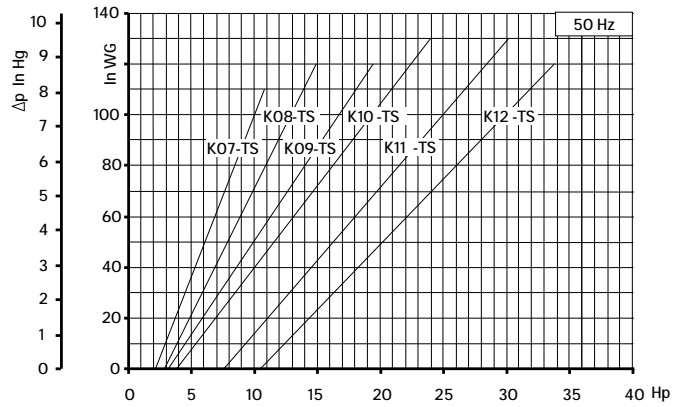
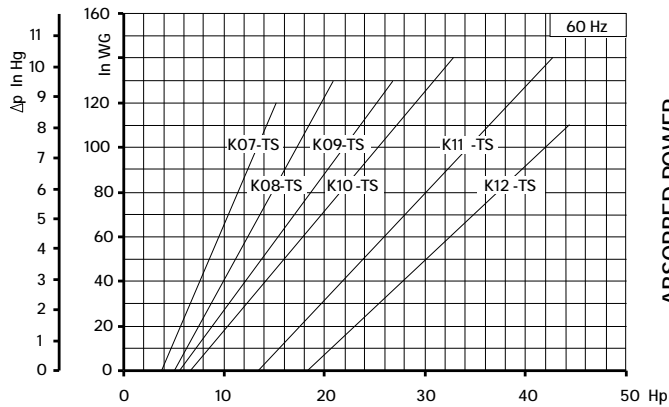
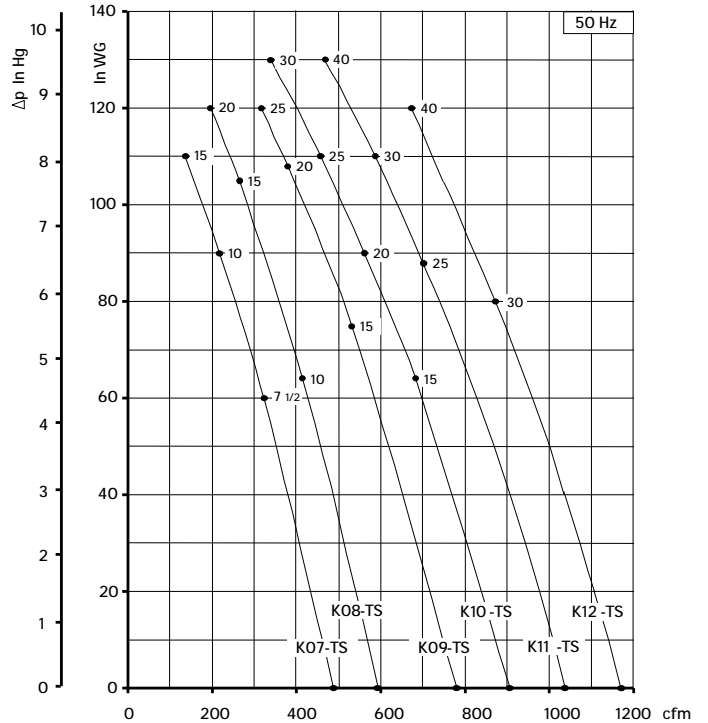
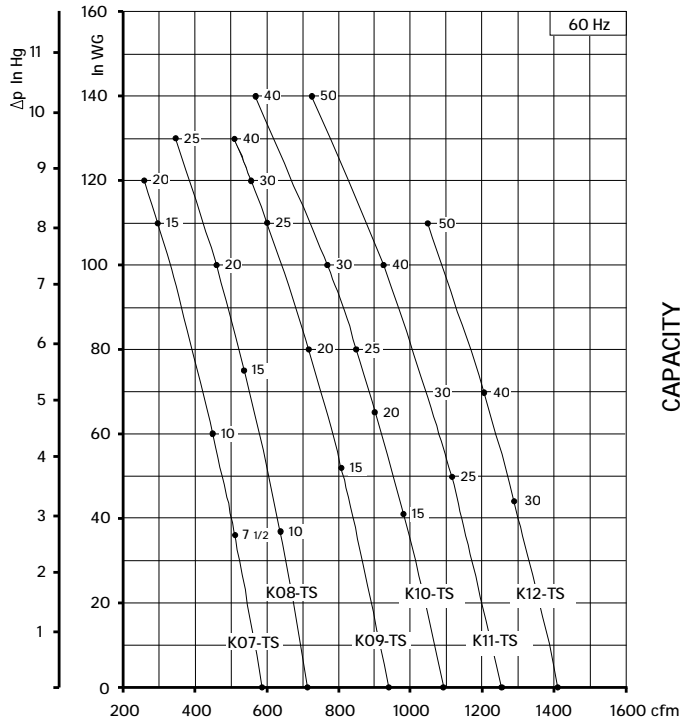

Curves refer to air at 68°F temperature, measured at inlet port and 29.92 In Hg atmospheric backpressure (abs).
 Values for flow, power consumption and temperature rise: +/-10% tolerance.
 Data subject to change without notice.



SCL K07R / K08R / K09 / K10 / K11 / K12

MD SERIES - GOR/GVR RANGE

SN 2150-3 1/2

TECHNICAL CHARACTERISTICS

- Aluminium alloy construction
- Smooth operation
- High efficiency impeller
- Maintenance free
- Mountable in any position

OPTIONS

- Special voltages (IEC 38)
- Surface treatments

ACCESSORIES

- Inlet and/or inline filters
- Additional inlet/outlet silencers
- Safety valves
- Flow converting device
- Optional connectors

GOR Range

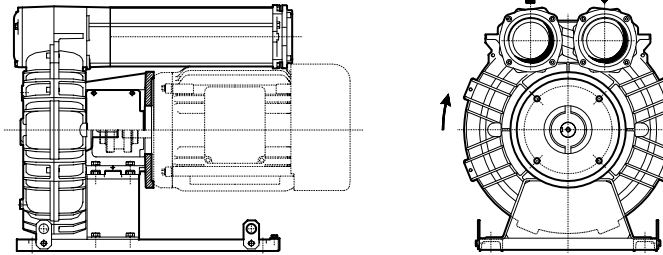

SCL Kxx-MD GOR-C

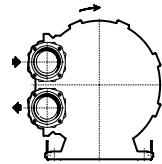

SCL Kxx-MD GOR-A

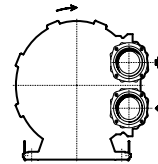

SCL Kxx-MD GOR-B

GVR Range

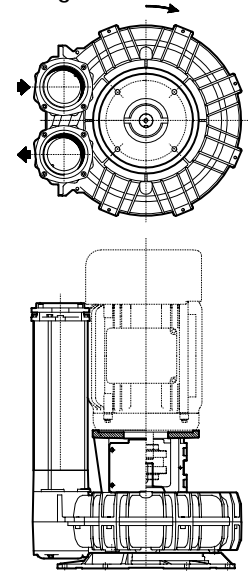

For dimensions, please refer to drw:

GOR range: SI 1918

GVR range: SI 1919

Model	Maximum flow cfm		Installed power Hp	Size	Maximum differential pressure Δp (In Hg)		Noise level Lp dB (A) ⁽¹⁾		Weight ⁽²⁾ Lbs
	60 Hz 3500 rpm	50 Hz 2900 rpm			60 Hz 3500 rpm	50 Hz 2900 rpm	60 Hz 3500 rpm	50 Hz 2900 rpm	
K07R-MD	129	107	3	NEMA 56C	5.0	6.4	72.5	70.5	112.00
				NEMA 143-5TC					112.00
			5	NEMA 182-4TC	10.7	12.5	73.5	71.5	113.80
			7 1/2	NEMA 182-4TC NEMA 213-5TC	13.2	13.2	74.0	72.0	113.80 113.80
K08R-MD	168	139	5	NEMA 182-4TC	5.9	8.1	75.7	73.7	130.30
			7 1/2	NEMA 182-4TC NEMA 213-5TC	11.9	13.2	76.1	74.1	130.30 130.30
			10	NEMA 213-5TC	13.2	-	76.5	-	130.30
K09-MD	221	183	5	NEMA 182-4TC	3.7	5.7	76.4	74.4	138.50
			7 1/2	NEMA 182-4TC NEMA 213-5TC	8.8	10.5	77.5	75.5	138.50 138.50
			10	NEMA 213-5TC	13.6	13.2	79.0	77.0	138.50
K10-MD	275	228	7 1/2	NEMA 182-4TC NEMA 213-5TC	6.3	8.1	80.4	78.4	125.40 152.40
			10	NEMA 213-5TC	10.3	12.1	80.7	78.7	152.40
			15	NEMA 213-5TC	14.7	14.0	81.3	79.3	152.40
K11-MD	306	254	10	NEMA 213-5TC	7.4	9.2	80.7	78.7	175.70
			15	NEMA 213-5TC NEMA 254-6TC	14.0	14.0	81.3	79.3	175.70 182.10
K12-MD	336	278	15	NEMA 213-5TC NEMA 254-6TC	7.4	13.2	82.2	80.2	183.40 189.80
			20	NEMA 254-6TC	13.2	-	82.5	-	189.80

(1) Noise measured at 1 m distance with inlet and outlet ports piped, in accordance to ISO 3744.

(2) Value is referred to weight of the machine without electric motor

- For proper use, the blower should be equipped with inlet filter and safety valve; other accessories available on request.
- Ambient temperature from +5° to +104°F.
- Specifications subject to change without notice.



SCL K07R / K08R / K09 / K10 / K11 / K12 MD SERIES - GOR/GVR RANGE

SN 2150-3 2/2

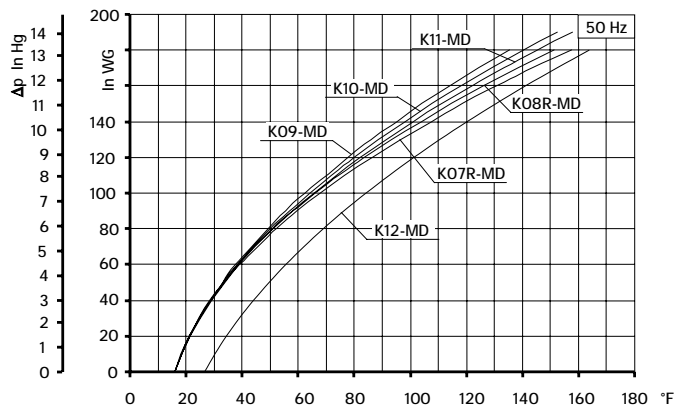
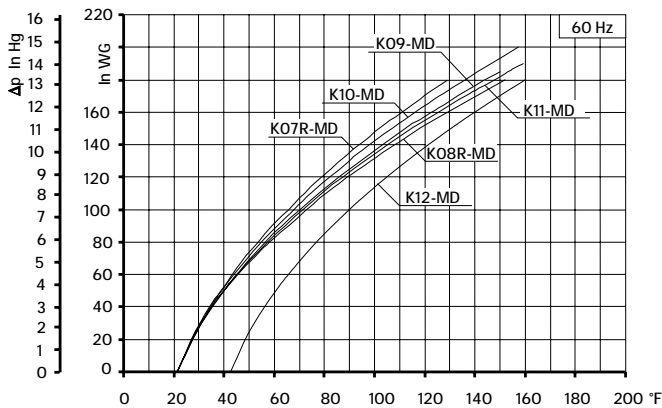
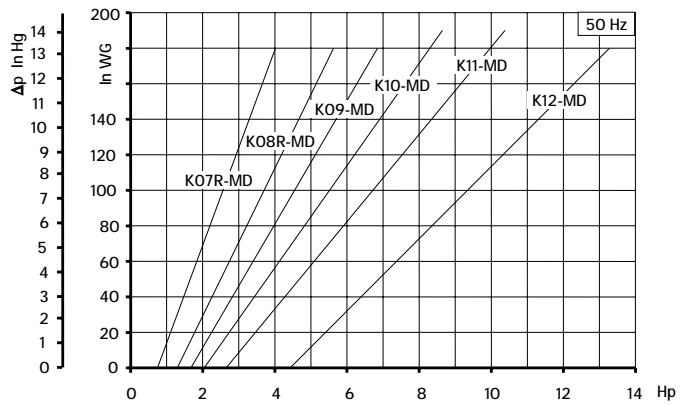
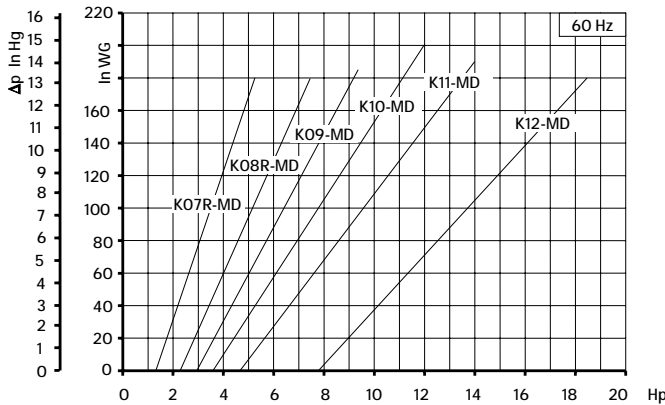
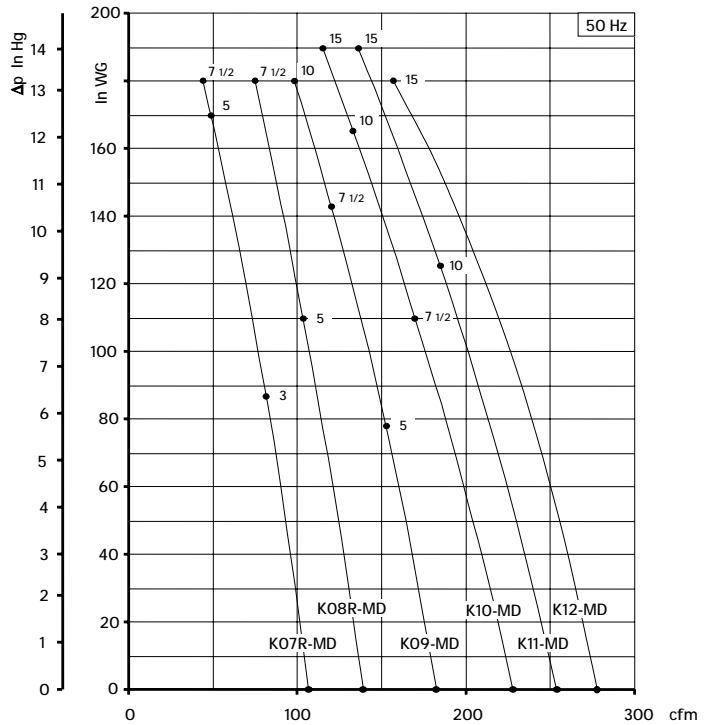
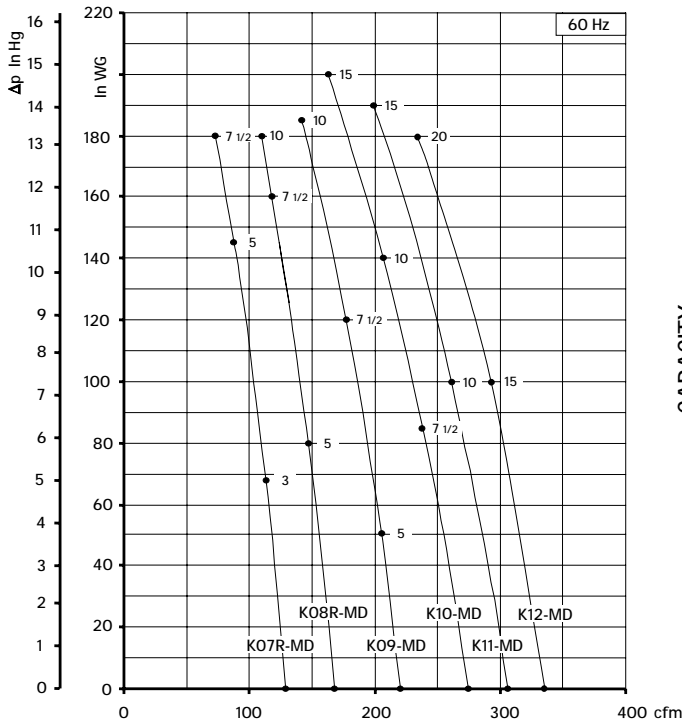

Curves refer to air at 68° F temperature, measured at inlet port and 29.92 In Hg atmospheric backpressure (abs).
Values for flow, power consumption and temperature rise: +/-10% tolerance.
Data subject to change without notice.



SCL K07 / K08 / K09 / K10 / K11 / K12

TD SERIES - GOR RANGE

SN 2180-5 1/2

TECHNICAL CHARACTERISTICS

- Aluminium alloy construction
- Smooth operation
- High efficiency impeller
- Maintenance free
- Mountable in any position
- G1/8" female thread on both suction and discharge silencer port flanges

OPTIONS

- Special voltages (IEC 38)
- Surface treatments

ACCESSORIES

- Inlet and/or inline filters
- Additional inlet/outlet silencers
- Safety valves
- Flow converting device
- Optional connectors

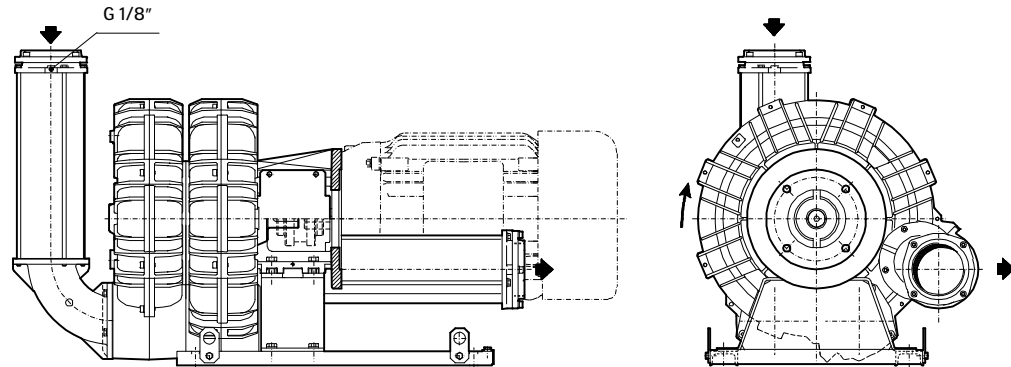

For dimensions, please refer to drw: SI1971

Model	Maximum flow cfm		Installed power Hp	Size	Maximum differential pressure Δp (In Hg)		Noise level Lp dB (A) ⁽¹⁾		Weight ⁽²⁾ Lbs
	60 Hz 3500 rpm	50 Hz 2900 rpm			60 Hz 3500 rpm	50 Hz 2900 rpm	60 Hz 3500 rpm	50 Hz 2900 rpm	
K07-TD	296	245	7 1/2	NEMA 182-4TC	6.6	9.6	78.6	76.6	156.50
				NEMA 213-5TC					
			10	NEMA 213-5TC	9.9	12.5	78.9	76.9	
			15	NEMA 254-6TC					
K08-TD	368	305	10	NEMA 213-5TC	7.0	10.3	79.3	77.3	169.80
			15	NEMA 213-5TC	12.5	12.5	79.9	77.9	169.80
				NEMA 254-6TC					178.60
K09-TD	467	387	15	NEMA 213-5TC	7.7	11.4	82.2	80.2	196.20
				NEMA 254-6TC					201.70
			20	NEMA 254-6TC	11.7	12.5	82.5	80.5	201.70
			25	NEMA 284-6TSC	13.2				82.8
K10-TD	571	473	15	NEMA 213-5TC	6.3	9.6	85.9	83.9	202.80
				NEMA 254-6TC					209.50
			20	NEMA 254-6TC	9.6	13.2	86.2	84.2	209.50
			25	NEMA 284-6TSC	13.2				86.5
K11-TD	642	532	20	NEMA 254-6TC	6.6	10.3	86.7	84.7	246.80
			25	NEMA 284-6TSC	9.6	13.2	87.2	85.2	244.70
			30	NEMA 284-6TSC	11.0				87.7
			40	NEMA 324-6TSC	12.5	88.1	264.50		
K12-TD	716	593	25	NEMA 284-6TSC	6.3	10.3	87.5	85.5	242.5
			30	NEMA 284-6TSC	8.8	13.2	88.0	86.0	242.5
			40	NEMA 324-6TSC	12.5	-	88.4	-	262.3

(1) Noise measured at 1 m distance with inlet and outlet ports piped, in accordance to ISO 3744.

(2) Value is referred to weight of the machine without electric motor

- For proper use, the blower should be equipped with inlet filter and safety valve; other accessories available on request.
- Ambient temperature from +5° to +104°F.
- Specifications subject to change without notice.



SCL K07 / K08 / K09 / K10 / K11 / K12

TD SERIES - GOR RANGE

SN 2180-5 2/2

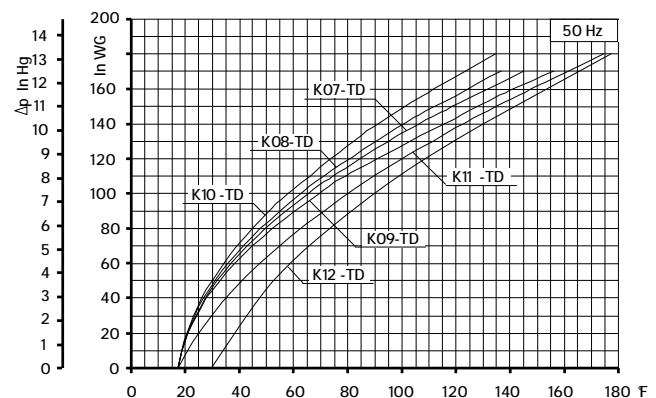
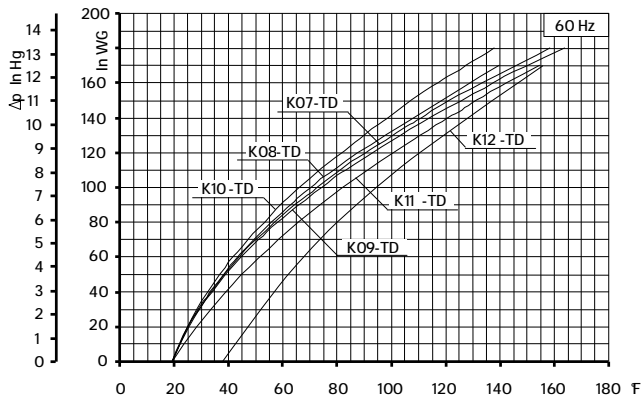
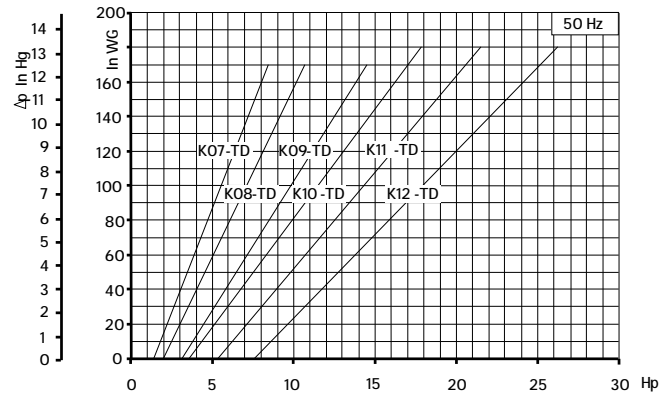
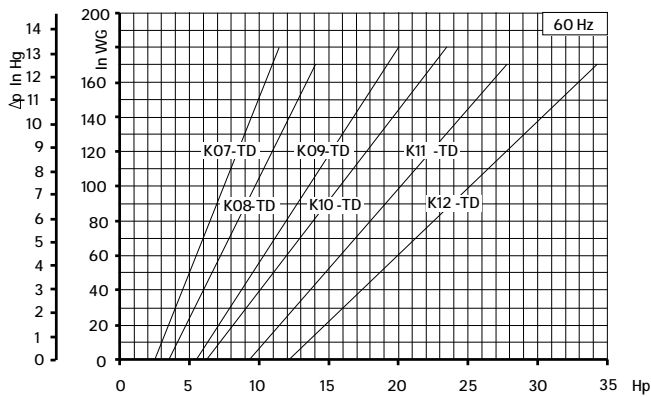
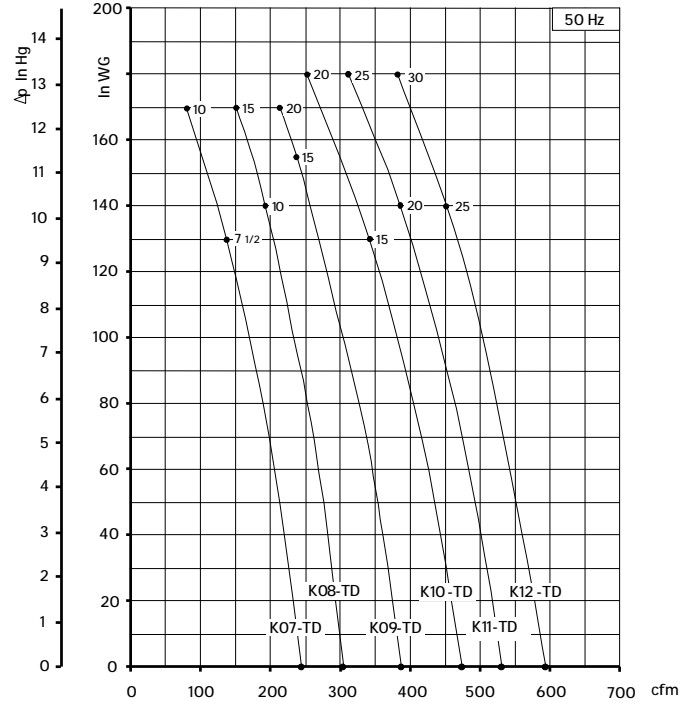
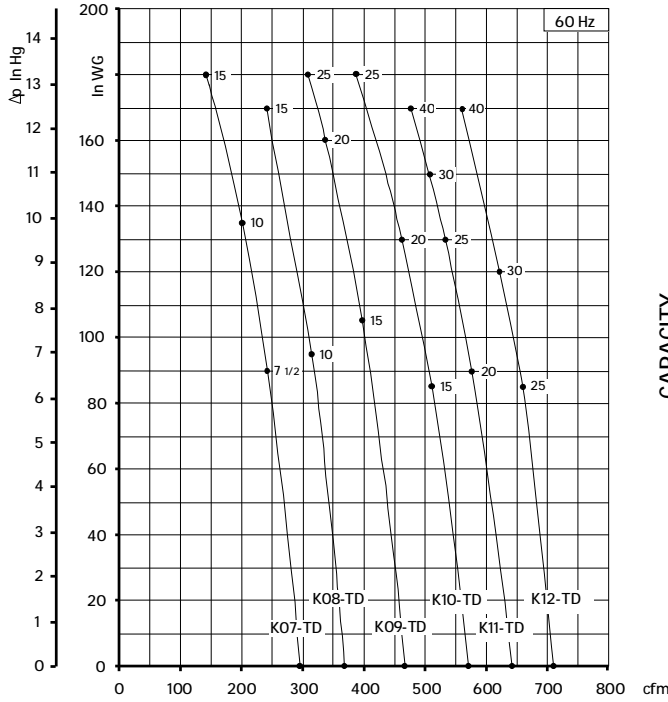

Curves refer to air at 68°F temperature, measured at inlet port and 29.92 In Hg atmospheric backpressure (abs).
 Values for flow, power consumption and temperature rise: +/-10% tolerance.
 Data subject to change without notice.

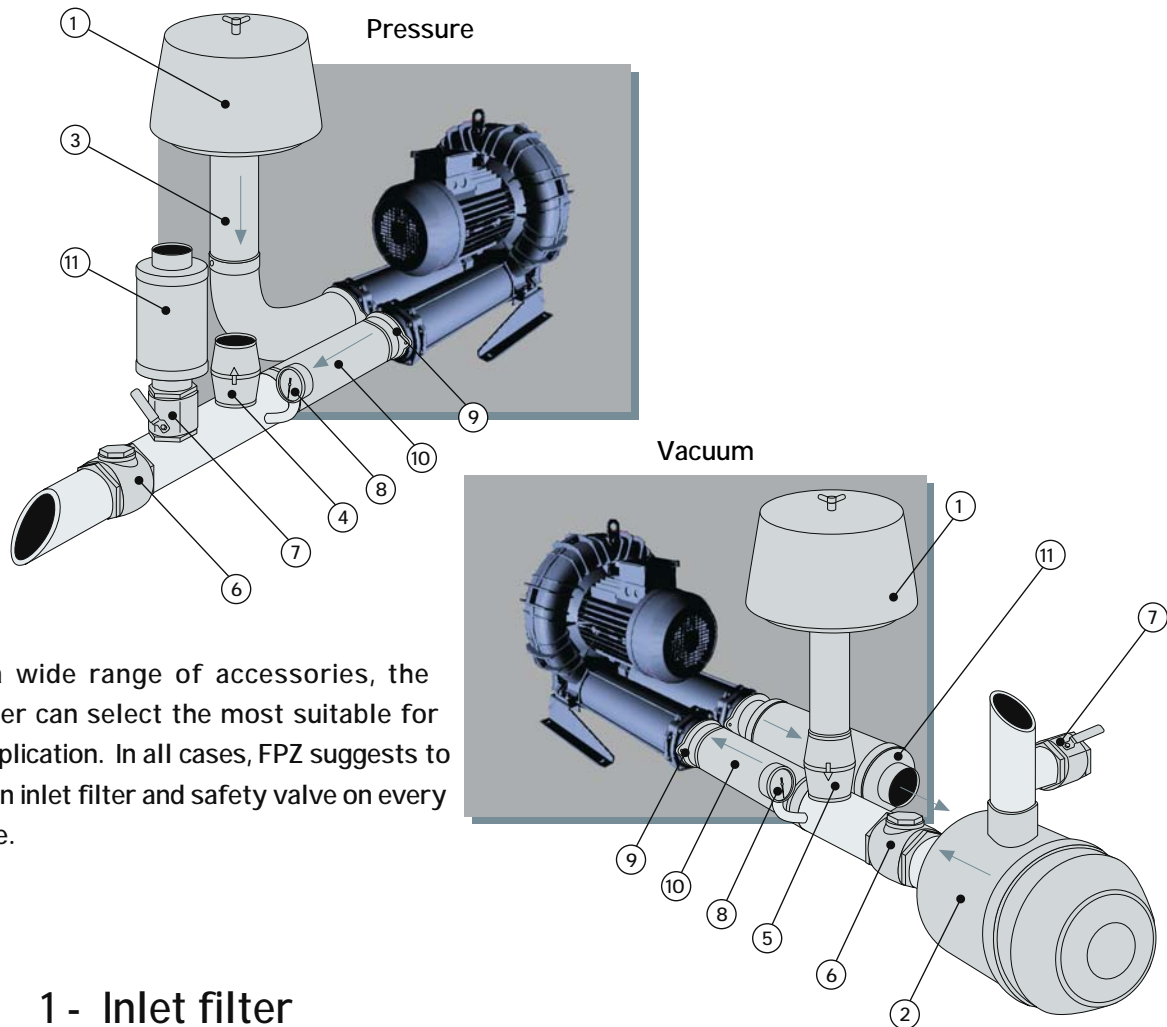

From a wide range of accessories, the customer can select the most suitable for their application. In all cases, FPZ suggests to install an inlet filter and safety valve on every machine.

- 1 - Inlet filter
- 2 - Inline filter
- 3 - Filter manifold
- 4 - Safety valve (pressure)
- 5 - Safety valve (vacuum)
- 6 - Check valve
- 7 - Ball valve (used to control flow by bleeding air)
- 8 - Pressure / Vacuum gauge
- 9 - Sleeve (for hose connection)
- 10 - Flexible hose
- 11 - Additional silencer

Gauges, Check Valves, Silencers, Enclosures

SS1708

Gauges

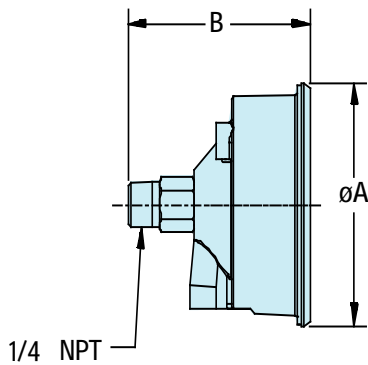

Gauges are important for monitoring the operating pressure or vacuum of the blower. Gauges should be positioned as close to the blower as possible.

Part number	Duty	Scale	A	B
VG25-60	Vacuum	0-60" H ₂ O	2.88	2.59
VG25-200	Vacuum	0-200" H ₂ O		
VG25-300	Vacuum	0-300" H ₂ O		
PG25-60	Pressure	0-60" H ₂ O		
PG25-200	Pressure	0-200" H ₂ O		
PG25-300	Pressure	0-300" H ₂ O		
PG25-15*	Pressure	0-15 psi	2.7	2.25

Dimensions in inches. Tolerance on given values ± 10% - unbinding and can be changed without prior notice.

*PG25-15 is suitable for outdoor use

Check Valves

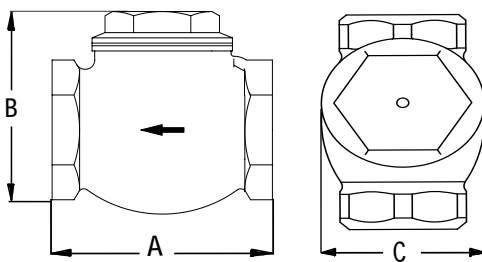

Swing check valves allow air to flow in one direction. These valves prevent backflow into the blower and are supplied in bronze or brass.

Part Number	NPT	A	B	C
CV075	0.75"	2.4		
CV10	1"	2.8	2.7	1.9
CV125	1.25"	3.2	3.2	2.2
CV15	1.5"	3.6	3.5	2.5
CV20	2"	4.3	4.2	3.1
CV30	3"	5.8	6.1	4.2
CV40	4"	6.9	7.1	5.5

Dimensions in inches. Tolerance on given values ± 10% - unbinding and can be changed without prior notice.

Silencers

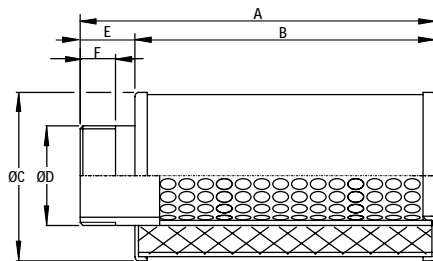

Silencers provide additional sound attenuation.

TYPE	D	A	B	C	E	F	lbs
SS 4	1" 1/4	7.5	5.5	2.8	2	0.6	0.8
SS 5	1" 1/2	7.9	6.7	3.1	1.2	0.8	1.1
SS 6	2"	9.1	7.9	3.5	1.2	0.8	1.3
SS 8	3"	19.1	15.7	6.0	3.3	0.8	4.8
SS 9	4"	18.3	16.9	6.7	1.1	0.8	9.9

Steel manufactured (apart from SI 9 / SS 9 - entirely in aluminium) with sound absorbing polyurethane element.

Dimensions in inches. Tolerance on given values ± 10% - unbinding and can be changed without prior notice.

Sound Enclosures

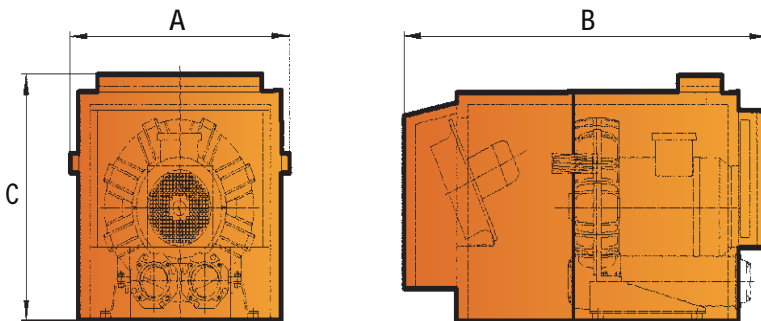

Part #	Used on models	A	B	C
IH1	SCL K03-MS	13.4	18.2	15.8
IH3	SCL K04-MS	14.3	19.7	16.5
IH5	SCL K05-6 MS + 30-40DH	16.9	26.8	21.3
IH7	SCL K07-8 MS / MD	31.7	64.4	26
IH8	SCL K07-8 TD	31.7	64.4	26
IH9	SCL K07-8 TS	31.7	64.4	26
IH10	SCL K09-12 MS/MD	31.7	67.2	30
IH11	SCL K09-10 TD	31.7	67.2	30
IH12	SCL K11-TD	31.7	67.2	30
IH13	SCL K09-11 TS	31.7	67.2	31.5

Dimensions in inches - unbinding and can be changed without prior notice.



The following table is a guide to select the appropriate safety valve. The selections in the table are based on blowers operating at **60 Hz** - for 50 hz applications refer to the safety valve data sheets. To select the appropriate safety valve, determine the blower - model, horsepower, and whether it is to be used for vacuum or pressure service. If it is desirable to have the valve activate at lower pressures than the maximum rated pressure or vacuum of the blower, a different safety valve might be required (refer to safety valve data sheets). In some cases, two valves are required. **FPZ valves are supplied uncalibrated.** All safety valves include detailed instructions on how to calibrate and install the valve.

Single Stage Blowers			
Model	HP	Safety Valve Vacuum	Safety Valve Pressure
K03-MS	3/4	VRL6	VRL6
K04-MS	ALL	VRL6	VRL6
K05-MS	ALL	VRL6	VRL6
K06-MS	3	VRL6	VRL8
K06-MS	4	VRL6	VRL6
K06-MS	5 1/2	VRL6	VRL6
K06-MS	6 1/5	VRL6	VRL6
K07-MS	4	VRL8	VRL8
K07-MS	5 1/2	VRL6	VRL8
K07-MS	7 1/2	VRL6	VRL6
K07-MS	10	VRL6	VRL6
K08-MS	5.5	VRL8	VRL9
K08-MS	7 1/2	VRL8	VRL8
K08-MS	10	VRL6	VRL8
K08-MS	15	VRL6	VRL6
K09-MS	7 1/2	VRL9	VRL9
K09-MS	10	VRL8	VRL8
K09-MS	15	VRL6	VRL8
K09-MS	20	VRL6	VRL6
K10-MS	7 1/2	VRL9	VRL9
K10-MS	10	VRL9	VRL9
K10-MS	15	VRL8	VRL8
K10-MS	20	VRL8	VRL8
K10-MS	25	-	VRL6
K11-MS	15	VRL9	VRL9
K11-MS	20	VRL8	VRL8
K11-MS	25	-	VRL8
K12-MS	15	VRL9	VRL9
K12-MS	20	VRL9	VRL9
K12-MS	25	VRL8	VRL8
K05-TS	5.5	VRL8	VRL8
K06-TS	5 1/2	VRL9	VRL9
K06-TS	7 1/2	VRL8	VRL8
K06-TS	10	VRL6	VRL8
K07-TS	7 1/2	VRL9	VRL9
K07-TS	10	VRL9	VRL9
K07-TS	15	VRL8	VRL8
K08-TS	15	VRL9	VRL9

Single Stage Blowers			
Model	HP	Safety Valve Vacuum	Safety Valve Pressure
K09-TS	20	VRL9	VRL9
K09-TS	25	VRL8	VRL9
K10-TS	20	(2) VRL9	(2) VRL9
K10-TS	25	VRL9	VRL9
K11-TS	25	(2) VRL9	(2) VRL9
K11-TS	30	(2) VRL9	(2) VRL9
K12-TS	30	(3) VRL9	(3) VRL9
Two Stage Blowers			
Model	HP	Safety Valve Vacuum	Safety Valve Pressure
15DH	ALL	VRL6	VRL6
R20-MD	ALL	VRL6	VRL6
R30-MD	ALL	VRL6	VRL6
R40-MD	ALL	VRL6	VRL6
K07R-MD	5 1/2	VRL6	VRL6
K07R-MD	7 1/2	VRL6	VRL6
K07R-MD	10	VRL6-HP	VRL6-HP
K08R-MD	5 1/2	VRL6	VRL6
K08R-MD	7 1/2	VRL6	VRL6
K08R-MD	10	VRL6	VRL6
K08R-MD	15	-	VRL6-HP
K09-MD	10	VRL6	VRL6
K09-MD	15	-	VRL6-HP
K10-MD	10	VRL6	VRL6
K10-MD	15	VRL6	VRL6
K10-MD	20	-	VRL6-HP
K11-MD	15	VRL6	VRL8
K11-MD	20	VRL6	VRL6-HP
K12-MD	15	VRL8	VRL8
K12-MD	20	VRL6	VRL8
K12-MD	25	-	VRL6
K05-TD	5 1/2	VRL6	VRL6
K06-TD	10	VRL6	VRL6
K07-TD	15	VRL6	VRL6
K08-TD	15	VRL6	VRL6
K09-TD	25	VRL6	VRL6
K10-TD	25	VRL6	VRL8
K11-TD	25	VRL8	VRL8
K12-TD	30	VRL8	VRL8

Valve selections are based on 60 Hz operation and refer to air having a density equal to 0.075 lbs / cu. Ft and inlet temperature of 68 deg F. Data is subject to change without notice



The VRL valves are designed to protect blowers and / or motors from over pressurization or excess vacuum. When there is over pressurization, the valve opens and discharges to the outside. When there is excess in vacuum, the valve opens and takes flow from outside.

The valves have been designed for low pressure / low vacuum, with minimal difference between the initial value at which the valve begins to open and its fully opened position. The valves are supplied with 2 different springs to maximize their efficiency. These compact valves, made of aluminum alloy, are both easy to install and calibrate, and operate in a wide range of capacities. The VRL can be plumbed to divert excess primary flow through a secondary external outlet when working in pressure conditions, or to pipe in a secondary flow when working in vacuum.

"HP" valves are used for pressures >240" H2O.

Maximum efficiency is achieved by keeping operating values (flow versus pressure or vacuum) within the operating range (shaded area on graph). Capacity refers to air having a density equal to 0.075 lbs./cu.ft .



VRL6
VRL6 HP

VRL8
VRL8 HP

VRL9

OPERATING RANGE

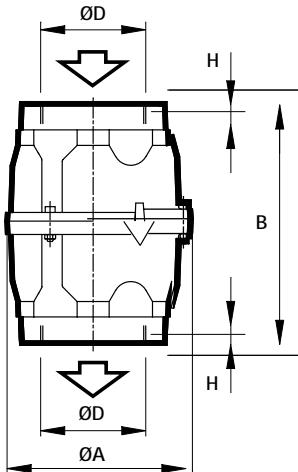
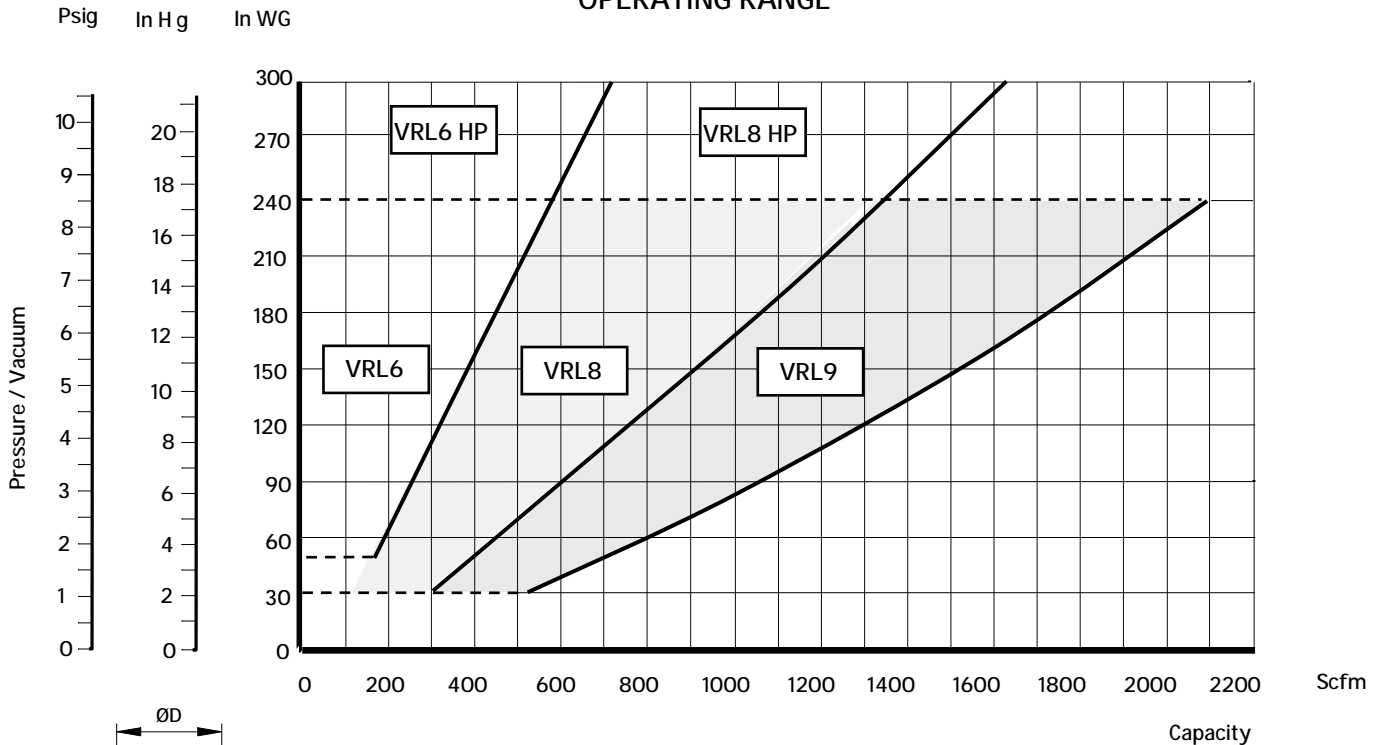

OVERALL DIMENSIONS

TYPE	ND	D	A	B	H	WEIGHT (Lbs)
VR6 & VRL6 HP	2"	2" NPT	4.02	6.90	0.47	1.9
VRL8 & VRL8HP	3"	3" NPT	5.31	7.48	0.59	4.2
VRL9	4"	4" NPT	6.30	8.11	0.71	5.7

- Dimensions in inches.
- Specifications subject to change without prior notice.

VRL valves are supplied uncalibrated - contact FPZ for calibration options.



FPZ inline filters are typically used in vacuum applications to prevent debris from entering the blower. Inline filters consist of a metal housing with a metal cover retained by quick-change clamps for easy servicing of the element. Polyester elements are recommended for humid applications.

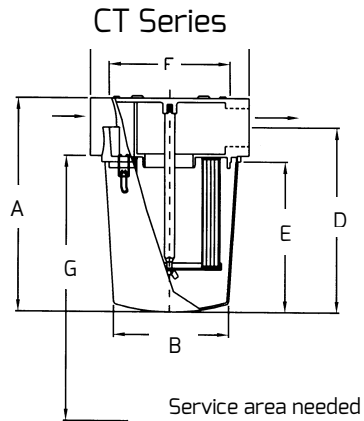
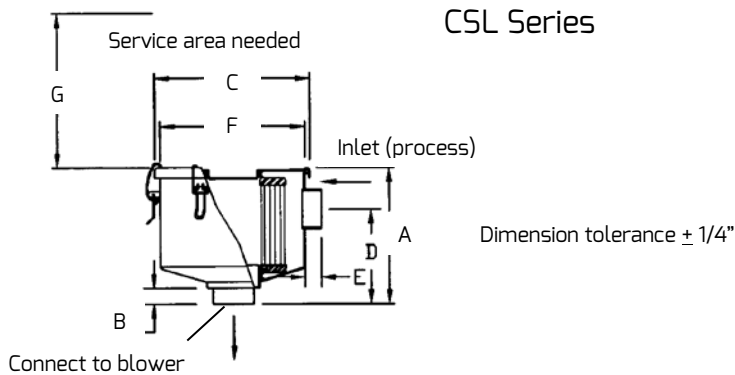

- ♦ Polyester: 99%+ removal efficiency standard to 5 micron
- ♦ Stainless steel torsion clips for durability
- ♦ Rugged construction with powder coated finish
- ♦ Low pressure drop
- ♦ Positive sealing O-ring seal system
- ♦ Large dirt holding capacity and easy field cleaning, (especially when mounted horizontally or inverted)
- ♦ Fully-drawn one piece canister
- ♦ Filter change out differential: 10"-15" H₂O Over Initial Delta P

- ♦ Various media available
- ♦ Epoxy coated housings
- ♦ Special connections
- ♦ Available in Stainless Steel
- ♦ Activated carbon prefilter to reduce odor
- ♦ Alternate Top-to-canister fastening system for low pressure or pulsating systems

Polyester Element	NPT	DIMENSIONS (Inches)							Used on Models	Approx Wt. Lbs
		A	B	C	D	E	F	G		
CSL-843-050HC	½"	4 ⅜	9/16	5 7/8	2 ½	9/16	5	3 ¼	10DL	3
CSL-843-075HC	¾"	4 ⅜	9/16	5 7/8	2 ½	9/16	5	3 ¼	15DH	3
CSL-843-100HC	1"	4 ⅜	¾	5 7/8	2 ½	¾	5	3 ¼	06	3
CSL-843-125HC	1 ¼"	4 ⅜	¾	5 7/8	2 ½	¾	5	3 ¼	K03-MS, R20-MD	3
CSL-849-125HC	1 ¼"	6 ¾	¾	7 5/16	4 ½	¾	6 13/16	5 ¼	R30-MD, R40-MD	5
CSL-849-150HC	1 ½"	6 ¾	¾	7 5/16	4 ½	¾	6 13/16	5 ¼	K04-MS	5
CSL-851-200HC	2"	10 ¼	¾	8 ¾	5	¾	7 5/8	9 ¼	K05-MS, K06-MS, K05-TD, K06-TD, K07R-MD, K08R-MD	15
CT-235P-300C	3"	18 13/16	9 7/8	13 ½	16 4/5	13 1/8	10	14	K05-TS, K06-TS, K07-MS, K08-MS, K07-TD, K08-TD	30
CT-235P-400C	4"	18 13/16	9 7/8	13 ½	16 4/5	13 1/8	10	14	K09-MS, K10-MS, K09-MD, K10-MD, K11-MD, K12-MD, K09-TD, K10-TD	29
CSL-2541-400I*	4"	16 3/8	3 5/8	13 ¼	9 ½	3 ½	12 1/16	8	K07-TS, K08-TS, K11-MS, K12-MS, K11-TD, K12-TD	38
CT-275P-500C	5"	18 ¼	16	19	14 3/8	9 7/8	14 ¾	20	K09-TS, K10-TS	50
CTD-375P-500C	5"	25 3/8	16	19	21 ½	17	14 ¾	35	K11-TS, K12-TS	60

* Male x male npt connections
 Dimensions for reference only



Inlet Filters

SS1905

FPZ inlet filters are used for pressure applications. The inlet filters combine filtration and sound attenuation into a compact package. Inlet filters consist of a filter cartridge enclosed by a carbon steel weather hood. Elements are easily serviceable by simply removing the weather hood.

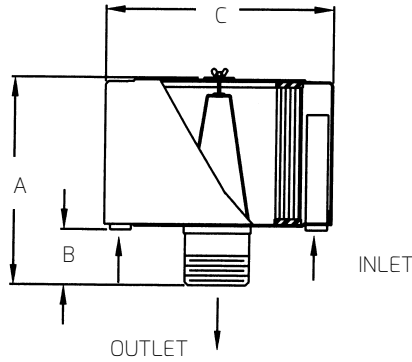

Dimension tolerance $\pm 1/8"$



VG-020-013



FEATURES & SPECIFICATIONS

- Polyester: 99%+ removal efficiency standard to 5 micron. (Other media available upon request.)
- Fully drawn weather hood - no welds to rust or vibrate apart
- Tubular silencing design - tube is positioned to maximize sound attenuation and air flow while minimizing pressure drop
- Durable carbon steel construction with baked enamel finish
- Filter change out differential: 10"-15" H₂O Over Initial Delta P.

OPTIONAL DIRTY FILTER INDICATOR

The **VG-020-013** dirty filter indicator is used to maximize filter life for pressure applications only. The yellow indicator in the site window drops as dirt accumulates on the filter element. The element is ready for change out or servicing when the yellow indicator reaches the red zone. The filter condition can be determined without removing the weather hood even after the blower has been shut down.

The indicator can be mounted in the inlet piping between the blower and filter or directly to the filter housing by having a 1/8" npt tap installed in the hood. If a tap is required, FPZ part number **MO20*** should be ordered.

Polyester Element	NPT	Dimensions (Inches)			Used on Models	Approx Wt. Lbs
		A	B	C		
FS-15-050	1/2"	4	1 1/2	6	10DL	2
FS-15-075	3/4"	4	1 1/2	6	15DH	2
FS-15-100	1"	4	1 1/2	6	O6	2
FS-19P-125	1 1/4"	6 5/8"	1 5/8"	6	K03-MS, R20-MD, R30-MD, R40-MD	3
FS-19P-150	1 1/2"	6 5/8"	1 5/8"	6	K04-MS	4
FS-31P-200	2"	7 1/4"	2 1/4"	10	K05-MS, K05-TD	8
FS-231P-200	2"	12 1/4"	2 1/4"	10	K06-MS, K06-TD, K07R-MD, K08R-MD	14
FS-231P-300	3"	13"	3"	10"	K07-MS, K05-TS, K07-TD	15
FS-235P-300	3"	13"	3"	16"	K08-MS, K06-TS, K08-TD	29
FS-235P-400	4"	14"	4"	16"	K09-MS, K10-MS, K09-MD, K10-MD, K11-MD, K12-MD, K09-TD, K10-TD	30
FS-245P-400	4"	14"	4"	16"	K07-TS, K08-TS, K11-MS, K12-MS, K11-TD, K12TD	31
FL10**	NA	14 3/8"	1 3/8"	16 3/16"	K09-TS, K10-TS, K11-TS, K12-TS,	18

*MO20 1/8" npt filter tap will be added to filter part number suffix if ordered.

**FL10 utilizes 15 micron paper element and does not include tubular silencers. FL10 filters are normally ordered with CA10



VK - FLANGE CONNECTOR FOR VRL VALVES

This VK flange accessory allows direct connection of the VRL relief valves to the cover of the SCL "K" model blowers; either in pressure or vacuum.

Note: VK flanges usable on K-MS and K-TS blowers in vacuum or pressure K-MD useable in vacuum only.

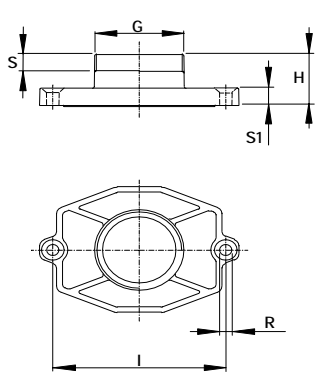

Fig. 1

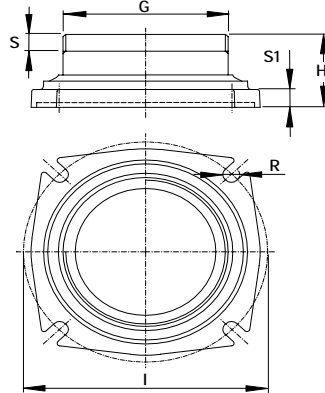
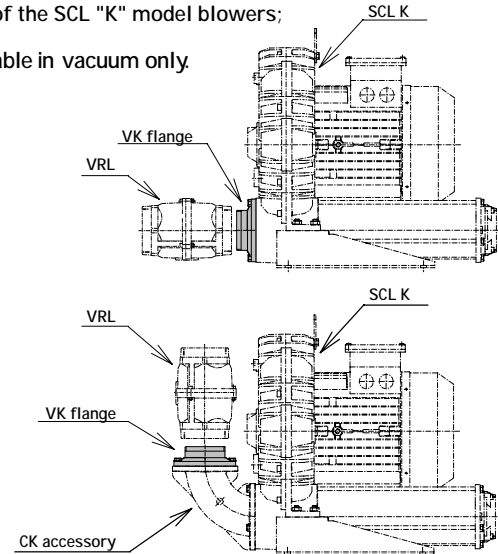

Fig. 2



Dimensions in Inches

Model	DN	G	H	I	R	S	S1	Fig.	Parts List
VK 5	1" 1/2	1" 1/2 NPT	1.18	3.62	0.26	0.59	0.39	1	SP 1552
VK 6	2"	2" NPT	1.97	4.33	0.33	0.75	0.39		SP 1553
VK 6A	2"	2" NPT	2.34	5.12	0.35	0.75	0.43	2	SP 1611
VK 8	3"	3" NPT	1.69	5.12	0.35	0.83	0.43		SP 1554
VK 9	4"	4" NPT	1.81	5.90	0.35	0.90	0.43		SP 1555

PK - FLANGED TUBE CONNECTOR FOR SCL K

The PK accessory allows connection of the "K" Series blowers directly to the process line without use of the intake or outlet manifolds.

CHARACTERISTICS

Flange in aluminium alloy with tube stub connection.

Supplied as a kit for mounting (with gasket and screws with wrench), please see the respective Parts List in table.

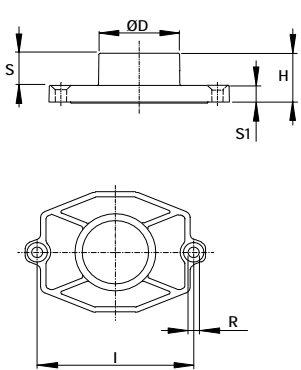

Fig. 1

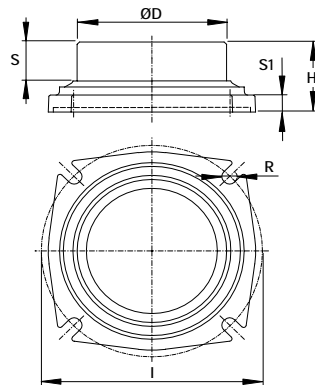
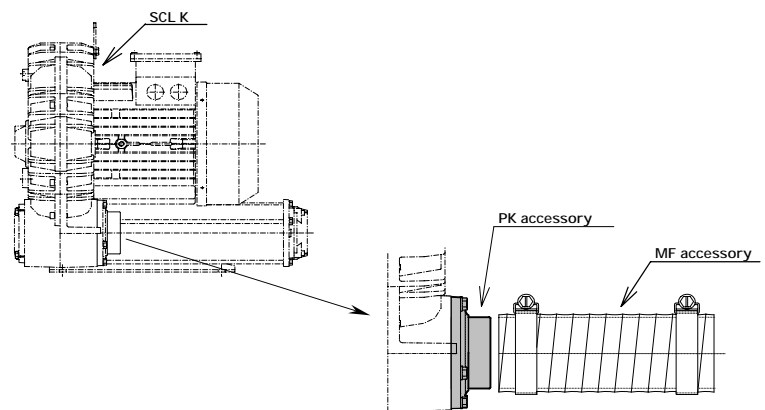

Fig. 2



Dimensions in Inches

Model	DN	D	H	I	R	S	S1	Fig.	Parts List
PK 5	1" 1/2	1.89	1.18	3.62	0.26	0.79	0.39	1	SP 1543
PK 6	2"	2.36	1.97	4.33	0.33	1.38	0.39		SP 1544
PK 6A	2"	2.36	2.34	5.12	0.35	1.38	0.43	2	SP 1609
PK 8	3"	3.46	1.69	5.12	0.35	0.94	0.43		SP 1545
PK 9	4"	4.48	1.81	5.90	0.35	1.06	0.43		SP 1546

Note: PK flanges usable on K-MS, K-TS, K-TD blowers in vacuum or pressure K-MD useable in vacuum only.



Flow Converting Devices

V6 / VS8
SN 2616-4 1/1

This all aluminum device is simple in both design and operation. Change of flow direction is attained by an electronically or pneumatically activated diverter.

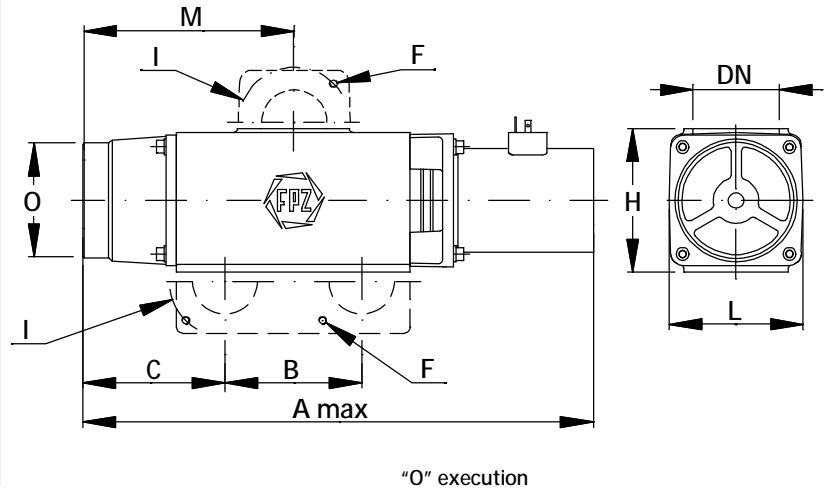
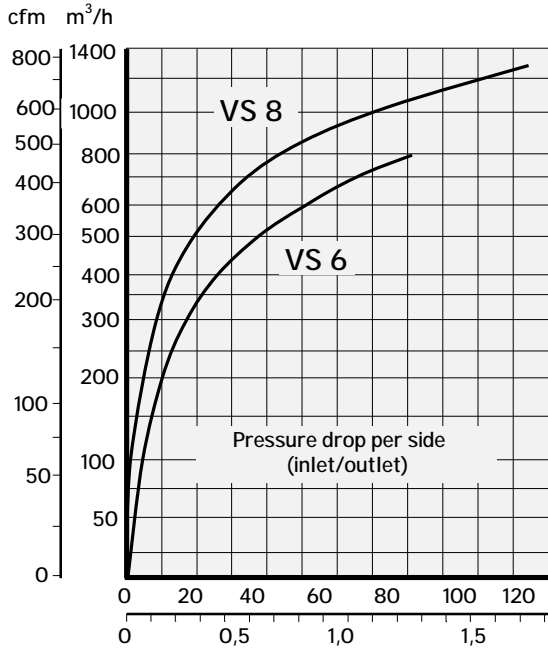

TYPE	DN	A		B	C	F	H	I	L	M	O
VS 6	2"	15.43 ⁽¹⁾	16.42 ⁽²⁾	4.13	4.29	M6	4.33	2 x int.3.35	3.94	6.38	3.46
VS 8	3"	19.09 ⁽¹⁾	20.08 ⁽²⁾	4.02	5.28	M6	6.3	4 x int.4.72	5.91	8.27	4.33

Overall dimensions refer to "O" execution without flanges

For the dimensions of the other executions pls see:

- SI 1787 Executions O/P
- SI 1788 Executions Y/H/K with pneumatic control
- SI 2021 Executions Y/H/K with electrical control

- (2) Electronically activated
- (3) Pneumatically activated

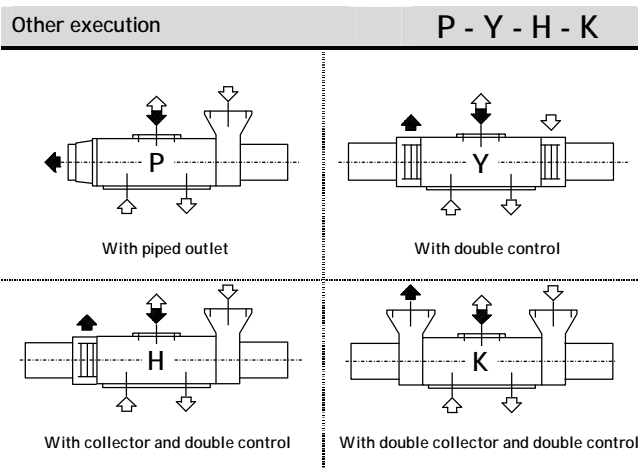

	EXECUTION	
	O/P	Y/H/K
Electrical control		
Thrust solenoid		
Working ratio	60% of cycle time	
Max. cycle duration	5 min.	
Max. activated time	5 min.	
Power rating	56 W	120 W (3)
Standard supply voltages	V: 24 DC-110 AC-220 AC	
(3) Only for VS6 (dp max. +350-350 mbar)		
Pneumatic control		
Thrust air cylinder	Double effect	
Max pressure	10 Bar	
Air consumption	0.02 litres/cycle	
Operating temperature	-5°C - +70 °C	

Available connection

- TF threaded flange GAS (G 1 1/2", G 2", G3");
- TF threaded flange NPT (NPT 1 1/2", NPT 2", NPT 3");
- See SU 0012.

Dimensions in inches. Tolerance on given values ±10 % - unbinding and can be changed without prior notice.

CA MANIFOLD FOR FA/FL/FS FILTERS

90° wide radius PVC manifold with flanged connection and unthreaded or female threaded tube end. Working temperature -20° to +40°C (-5°/+105 °F).

Type	DN	A	B	D	S	I	M	R	Fig.
CA4-K	1.25"	10.24	6.30	1.65	0.59	2.52	0.28	3.15	1
CA4K-NPT	1.25" npt	11.61	6.30	1.65	0.59	2.52	0.28	3.15	1
CA5-K	1.5"	11.81	7.09	1.89	0.59	2.95	0.28	3.94	1
CA5K-NPT	1.5" npt	12.80	7.09	1.89	0.59	2.95	0.28	3.94	1
CA6V	2"	12.60	5.31	2.36	0.59	3.35	0.28	4.96	1
CA6V-NPT	2" npt	13.60	5.31	2.36	0.59	3.35	0.28	4.96	1
CA8	3"	14.96	7.28	3.48	0.59	4.72	0.28	7.09	1
CA8-NPT	3" npt	16.65	7.28	3.48	0.59	4.72	0.28	7.09	1
CA9	4"	15.75	9.25	4.48	0.79	5.91	0.35	8.66	2
CA9-NPT	4" npt	17.44	9.25	4.48	0.79	5.91	0.35	8.66	
CA10	5"	4.92	11.81	5.51	0.79	8.27	0.71	11.02	

Dimensions in inches - unbinding and can be changed without prior notice.

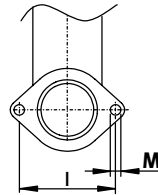
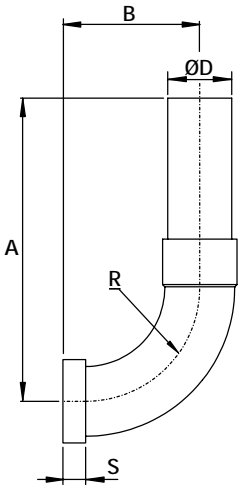

Fig. 1

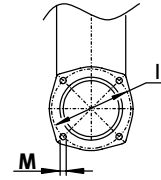

Fig. 2

CK MANIFOLD

90° aluminium manifold for "K" models supplied in a kit containing the gasket and bolts.

Fig. 1

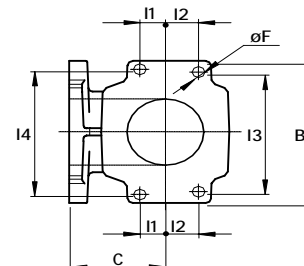
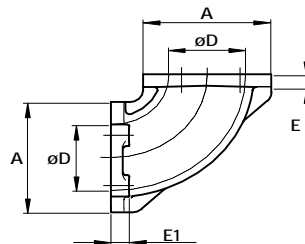
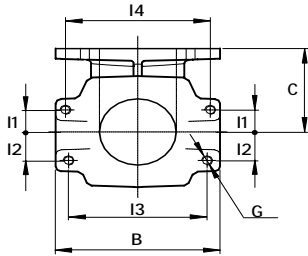
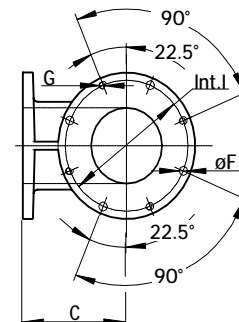
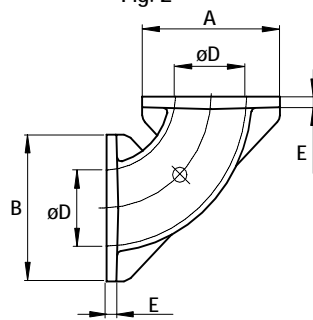
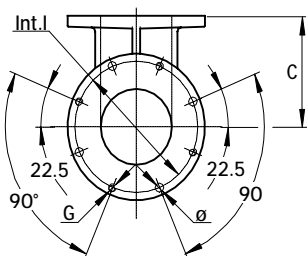

Fig. 2



Type	DN	A	B	C	D	E	E1	F	G	I	I1	I2	I3	I4	Fig.
CK5	1.5"	3.15	3.94	2.20	1.69	0.27	0.45	0.27	M6	-	0.69	0.69	3.35	3.35	1
CK6	2"	3.62	4.65	2.72	2.16	0.31	0.51	0.35	M8	-	0.73	0.95	3.92	4.10	
CK8	3"	5.71	5.71	4.31	2.95	0.39	-	0.35	M8	5.12	-	-	-	-	2
CK9	4"	6.50	6.50	5.22	3.54	0.39	-	0.35	M8	5.90	-	-	-	-	
CK10	5"	8.66	8.66	7.56	5.04	0.39	-	0.35	M8	7.48	-	-	-	-	

Dimensions in inches - unbinding and can be changed without prior notice.

FLEXIBLE CONNECTION

Steel reinforced rubber - coated fibreglass flex tubing, including 2 adjustable hose clamps. Working temperature: -55 ÷ +176 °C (-67 ÷ +350 °F). Maximum working pressure: 3 bar (44 psi).

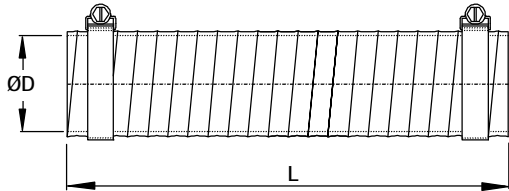

TYPE	DN	D	L
MF 1	1/2"	20	200
MF 2	3/4"	26	200
MF 3	1"	32	200
MF 4	1" 1/4	45	200
MF 5	1" 1/2	50	250
MF 6	2"	64	250
MF 8	3"	89	330
MF 9	4"	114	330
MF 10	5"	140	330

THREADED FLANGE

Threaded flange in aluminum alloy.

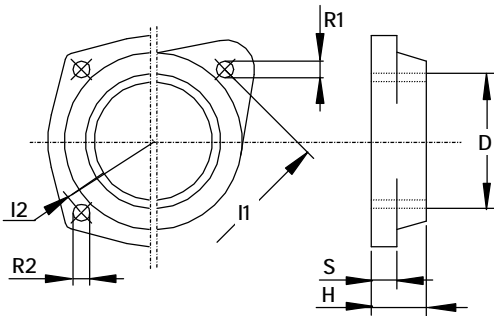

TYPE	D	H	I1	I2	R1	R2	S
TF 4N	1" 1/4 npt	18	75	-	6.5	-	10
TF 4VN	1" 1/4 npt	18	64	-	6.5	-	10
TF 5N	1" 1/2 npt	18	85	-	6.5	-	10
TF 5VN	1" 1/2 npt	18	75	-	6.5	-	10
TF 6N	2" npt	18	85	-	6.5	-	10
TF 8N	3" npt	25	-	120	-	6.5	13
TF 9N	4" npt	25	-	150	-	9	13
TF 10N	5" npt	35	-	210	-	17	13

SLEEVE

Aluminum alloy or steel flanged sleeve coupling.

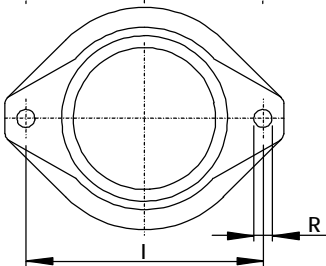
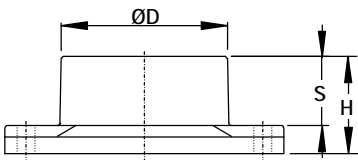

Fig. 1
Mat.: Al

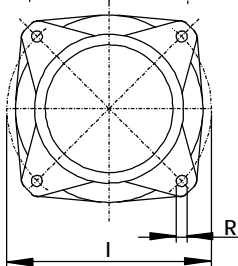
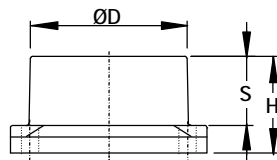

Fig. 2
Mat.: Al

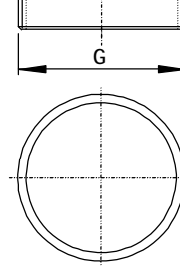
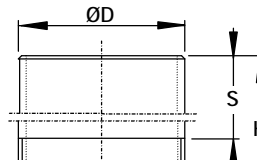

Fig. 3
Mat.: Fe

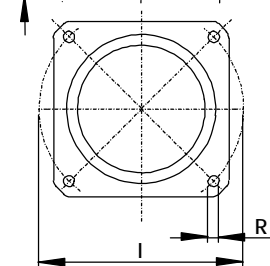
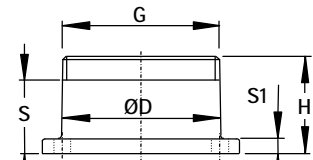

Fig. 4
Mat.: Fe

TYPE	DN	D	G	H	I	R	S	Fig.
MP 3	1"	33	-	35	55	6.5	25	1
MP 4	1" 1/4	42	-	35	75	6.5	25	
MP 4V	1" 1/4	42	-	35	64	6.5	25	

TYPE	DN	D	G	H	I	R	S	S1	Fig.
MP 5V	1" 1/2	48	-	35	75	6.5	25	-	1
MP 6	2"	60	-	35	85	6.5	25	-	
MP 8	3"	88	-	45	120	6.5	32	-	2
MP 9	4"	114	4" npt	100	-	-	80	-	3
MP 10	5"	140	5" npt	60	210	18	40	8	4

Dimensions in mm. Tolerance on given values ± 10% - unbinding and can be changed without prior notice.



PSI	In. H ₂ O	In. Hg	mBar	mmH ₂ O
1	27.68	2.04	68.95	703.0
1.5	41.5	3.05	103.43	1054.5
2	55.4	4.07	137.90	1406.0
2.5	69.2	5.09	172.38	1757.5
3	83.0	6.11	206.85	2109.0
3.5	96.9	7.13	241.33	2460.5
4	110.7	8.14	275.80	2812.0
4.5	124.6	9.16	310.28	3163.5
5	138.4	10.18	344.75	3515.0
5.5	152.2	11.20	379.23	3866.5
6	166.1	12.22	413.70	4218.0
6.5	179.9	13.23	448.18	4569.5
7	193.8	14.25	482.65	4921.0
7.5	207.6	15.27	517.13	5272.5
8	221.4	16.29	551.60	5624.0
8.5	235.3	17.31	586.08	5975.5
9	249.1	18.32	620.55	6327.0
9.5	263.0	19.34	655.03	6678.5
10	276.8	20.36	689.50	7030.0

Pressure			
In. H ₂ O	x	0.03613	= psi
In. H ₂ O	x	0.07355	= In. Hg
mbar	x	0.4019	= In. H ₂ O
psi	x	2.036	= In. Hg

Flow			
m ³ /h	x	0.588	= cfm
lpm	x	0.03528	= cfm
cfm	x	1.699	= m ³ /h
cfm	x	28.32	= lpm

Length			
Feet	x	12	= Inches
Inches	x	2.54	= cm
Feet	x	0.3048	= meters

Barometric pressure varies in direct proportion to altitude

Example #1 – If a blower is required to deliver 2 psig at 5000 feet, what pressure at standard air is required?

$$\text{Pressure} = 14.7 / 12.23 \times 2 = 2.4 \text{ psig}$$

Example #2– If a blower is required to deliver 2 psig at standard air, what pressure will it deliver at 5000 feet?

$$\text{Pressure} = 12.23 / 14.7 \times 2 = 1.66 \text{ psig}$$

Altitude Versus Barometric Pressure

Altitude Feet	Pressure		Altitude Feet	Pressure		Altitude Feet	Pressure	
	In. Hg.	Psia		In. Hg.	Psia		In. Hg.	Psia
0	29.92	14.70	1500	28.33	13.90	7000	23.09	11.34
500	29.38	14.43	2000	27.82	13.67	7500	22.65	11.12
600	29.28	14.38	2500	27.31	13.41	8000	22.22	10.90
700	29.18	14.33	3000	26.81	13.19	8500	21.80	10.70
800	29.07	14.28	3500	26.32	12.92	9000	21.38	10.50
900	28.97	14.23	4000	25.84	12.70	9500	20.98	10.90
1000	28.86	14.18	4500	25.36	12.45	10000	20.58	10.10
1100	28.75	14.09	5000	24.89	12.23	10500	20.18	9.91
1200	28.65	14.04	5500	24.43	12.00	11000	19.79	9.72
1300	28.54	13.99	6000	23.98	11.77	11500	19.41	9.53
1400	28.44	13.94	6500	23.53	11.56	12000	19.03	9.35

SINGLE PHASE DUAL VOLTAGE

GENERAL SPECIFICATIONS:

- | | |
|--|--|
| <ul style="list-style-type: none"> 1. Type: AC Motor IEC 60034 2. Marks: cURus, CE 3. Poles: 2 4. Insulation class: F 5. Frequency: 60 hz 6. Enclosure: TEFC | <ul style="list-style-type: none"> 7. Protection IP55, Tropicalized 8. Thermal protector: Klixon 140^o C or 150^o C (R series) 9. Max. Ambient 40^o C 10. Duty: Continuous 11. Construction: aluminum frame |
|--|--|

POWER		SIZE	VOLTAGE (60 hz)	Full Load Amperage	Starting Current A	Power Factor	SF	Capacitor μF	Cable Entry
HP	KW								
0.33	0.25	63	115 / 208-230	3.5 / 1.7	12.3 / 6.0	0.97	1.0	16 - 400 V	M16
0.5	0.37	63	115 / 208-230	4.8 / 2.6	16.8 / 9.1	0.96	1.0	16 - 400 V	M16
0.75	0.55	71	115 / 208-230	9.8 / 4.9	46.1 / 23.0	0.95	1.0	20 - 400 V	M16
0.75	0.55	71	115 / 208-230	8.3 / 4.1-4.2	34.9 / 17.2	0.83	1.15	30 - 450 V	M20
1	0.75	80	115 / 208-230	13.0 / 7.2	49.4 / 24.7	0.77	1.0	31.5 - 400 V	M20
1	0.75	80	115 / 208-230	9.4 / 5.5-5.0	35.8 / 17.3	0.99	1.15	40 - 450 V	M20
1.5	1.1	80	115 / 208-230	13.6 / 7.3	54.4 / 29.2	0.97	1.0	50 - 400 V	M20
1.5	1.1	80	115 / 208-230	14.6 / 7.6-7.3	49.3 / 23.2	0.97	1.15	45 - 450 V	M20
1.5*	1.1	80	115 / 208-230	14.3 / 7.18	71.1 / 35	0.96	1.0	55 - 450 V	M20
2	1.5	90	115 / 208-230	24.0 / 12.0	79.2 / 39.6	0.90	1.0	70 - 400 V	M20
2	1.5	90	115 / 208-230	19.7 / 10.6-9.9	103 / 52.4	0.95	1.15	50 - 450 V	M20
2*	1.5	80	115 / 208-230	19.4 / 9.8	96 / 48.2	0.89	1.0	55 - 450 V	M20
3	2.2	90	115 / 208-230	31.5 / 16.0	154.4 / 78.4	0.85	1.0	60 - 400 V	M20
3	2.2	90	115 / 208-230	29.4 / 16.6-14.8	119.8 / 61.8	0.91	1.15	45 - 450 V	M20
3*	2.2	90	115 / 208-230	26.2 / 13.1	152 / 76	0.95	1.0	70 - 450 V	M20

* Applicable to R series ONLY.

Shaded models to be discontinued.

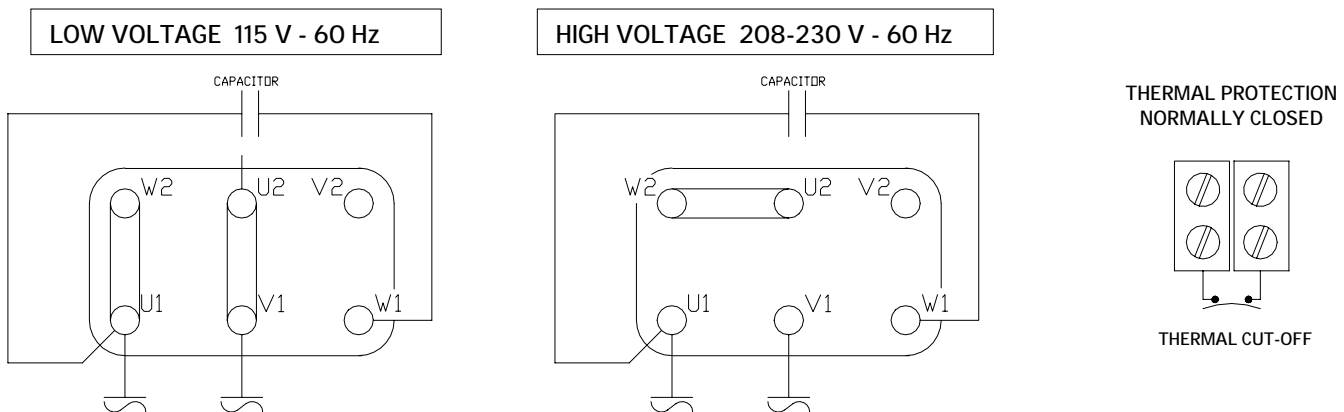

Specifications subject to change without notice. Alternate motor suppliers may be used.

THREE PHASE MOTOR

GENERAL SPECIFICATIONS:

1. Type: 3-phase AC Motor IEC 60034
2. Marks: cURus, CE
3. Nema Premium Efficiency (IE3) - 1 HP AND LARGER (3 ph)
4. Poles: 2
5. Insulation class: F; F (B) for Premium efficient
6. Enclosure: TEFC
7. Protection IP55, Tropicalized
8. Thermal protector: Klixon 1400 C/150^o C
9. Service factor: 1.15 (60 hz)
10. Max. Ambient 40^o C
11. Duty: Continuous
12. Construction: aluminum frame

POWER		SIZE	60 HZ			50 HZ			60 hz Starting Current Ratio*	CABLE ENTRY 1 (cable gland incl.)	CABLE ENTRY 2
HP	KW		VOLTAGE	FLA 208-230 / 460 V	Efficiency	VOLTAGE	FLA 200/400 V	Efficiency			
0.33	0.25	63	208-230/460	1.5 / 0.7	59%	230/400	1.4 / 0.8	60.0%	3.9	M16	M20
0.5	0.37	63	208-230/460	2.3 / 1.0	59.2%	230/400	2.1 / 1.2	61.4%	3.6	M16	M20
0.75	0.55	71	208-230/460	2.7 / 1.2	68.8%	230/400	2.6 / 1.5	69.0%	3.8	M16	M20
0.75	0.55	71	208-230/460	2.3-2.2 / 1.3	74.5%	230/400	2.6 / 1.5	74.5%	6.8	M20	-
1	0.75	80	208-230/460	2.99-2.94 / 1.47	77.0%	200/400	3.28 / 1.64	80.7%	8.0	M25	M25
1.5	1.1	80	208-230/460	4.35-4.34 / 2.17	84.0%	200/400	4.92 / 2.46	82.8%	9.3	M25	M25
2	1.5	80**	208-230/460	5.91-5.96 / 2.98	85.5%	200/400	6.82 / 3.41	84.2%	8.7	M25	M25
		90	208-230/460	5.77-5.74 / 2.87	85.5%	200/400	6.58 / 3.29	84.2%	9.4	M25	M25
3	2.2	90	208-230/460	8.27-8.31 / 4.15	86.5%	200/400	9.6 / 4.8	85.9%	10.7	M25	M25
4	3	100	208-230/460	10.9-11.1 / 5.53	88.5%	200/400	12.86 / 6.38	87.1%	11.0	M25	M25
5.5	4	100	208-230/460	14.6-15.1 / 7.55	88.5%	200/400	17.7 / 8.86	88.1%	11.1	M25	M25
6.2	4.6	100	208-230/460	16.5-16.4 / 8.2	89.5%	200/400	19 / 9.5	88.6%	12.5	M25	M25
7.5	5.5	132	208-230/460	19.8-19.5 / 9.75	89.5%	200/400	22.2 / 11.1	89.2%	13.7	M25	M25
10	7.5	132	208-230/460	26.1-25 / 12.5	90.2%	200/400	28.6 / 14.3	90.1%	13.0	M25	M25
15	11	132	208-230/460	38.2-37.3 / 18.7	91.0%	200/400	43.4 / 21.7	91.0%	12.5	M25	M25
20	15	132	208-230/460	47.0 / 23.5	91.7%	200/400	52.4 / 26.2	91.9%	9.7	M32	M32
20***	15	160	208-230/460	48.8 / 24.4	91.0%	200/400	54.4 / 27.2	91.9%	10.7	M32	M32
25	18.5	160	208-230/460	62 / 31	91.7%	200/400	69 / 34.5	92.4%	12.5	M40	M40
30	22	160	208-230/460	71.6/35.8	91.7%	200/400	77.8 / 38.9	92.7%	10.6	M40	M40

* FLA x starting current ratio = starting current ** 2 hp size 80 motors used on SCL R30-MD ONLY. *** T5 / TD models ONLY.

Shaded models to be discontinued

WIRING DIAGRAMS

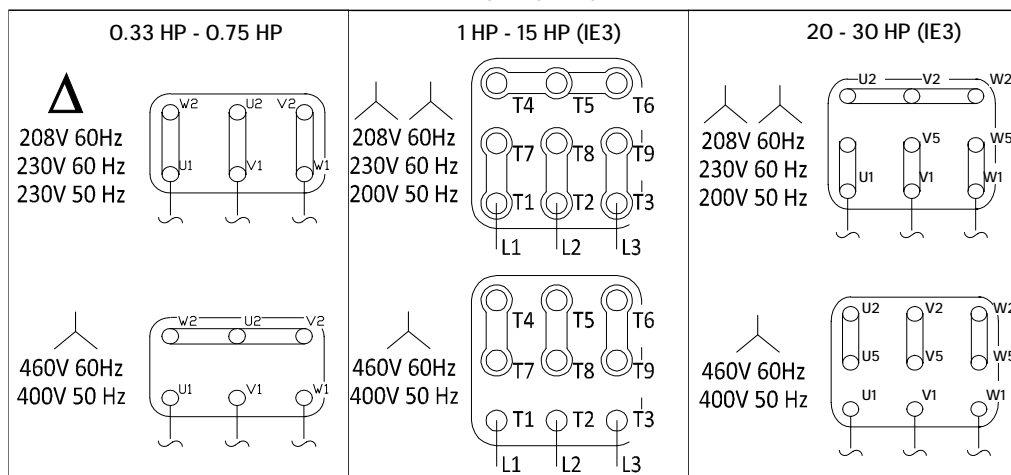

Thermal protection

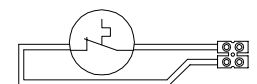

$V_N = 250V$, $\cos\phi 0,6$, $I_N = 1,6 A$
 $V_N = 250V$, $\cos\phi 1$, $I_N = 2,5 A$

Specifications subject to change without notice. Alternate motor suppliers may be used.



575 Volt Three Phase Electric Motors

TECHNICAL

SS2101

575 V THREE PHASE MOTOR

GENERAL SPECIFICATIONS:

- | | |
|--|---|
| 1. Type: 3-phase AC Motor IEC 60034 | 7. Protection IP55, Tropicalized |
| 2. Marks: cURus, CE, Nema Premium Efficiency (IE3) | 8. Thermal protector: Klixon 150 ⁰ C |
| 3. Poles: 2 | 9. Service factor: 1.15 (60 hz) |
| 4. Insulation class: F (B) | 10. Max. Ambient 40 ⁰ C |
| 5. Frequency: 60 hz / 50 hz | 11. Duty: Continuous |
| 6. Enclosure: TEFC | 12. Construction: aluminum frame |

POWER		SIZE	60 HZ			Starting Current A	Cable Entry
HP	KW		VOLTAGE	FLA 575 V	Efficiency		
1	0.75	80	575	1.18	77.0%	9.5	M25
1.5	1.1	80	575	1.74	84.0%	16.2	M25
2	1.5	80*	575	2.14	85.5%	17.0	M25
		90	575	2.3	85.5%	21.7	M25
3	2.2	90	575	3.0	86.5%	29.1	M25
4	3	100	575	3.94	88.5%	39.8	M25
5.5	4	100	575	5.31	88.5%	57.9	M25
6.2	4.6	100	575	6.0	89.5%	-	M25
7.5	5.5	132	575	7.21	89.5%	97.4	M25
10	7.5	132	575	10	90.2%	129.0	M25
15	11	132	575	13.9	91.0%	152.9	M25
20	15	132	575	18.8	91.0%	184.3	M25
25	18.5	160	575	24.8	91.7%	310.0	M40
30	22.0	160	575	28.6	91.7%	303.2	M40

* 2 hp size 80 motors used on SCL R30-MD ONLY.

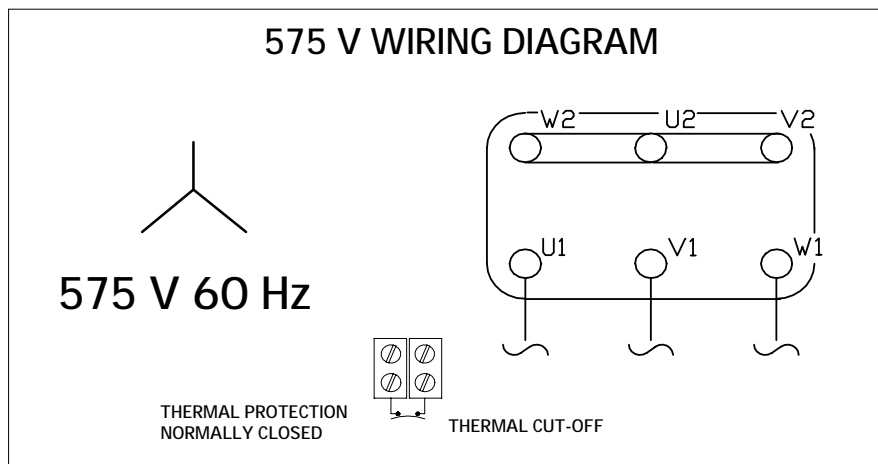

Specifications subject to change without notice. Alternate motor suppliers may be used.



Airflow Through an Orifice

Pressure

Orifice Diameters - Inches

Pressure " H ₂ O	1/32	1/16	1/8	3/16	1/4	5/16	3/8	7/16	1/2	5/8	3/4	1	1-1/4	1-1/2	1-3/4	2.0	2-1/4	2-1/2	2-3/4	3
1	0.0	0.1	0.2	0.5	0.9	1.4	2.0	2.7	3.5	6	7.8	14	22	31	43	56	70	87	105	125
2	0.0	0.1	0.3	0.7	1.2	1.9	2.8	3.8	4.9	8	11	20	31	44	60	79	100	123	149	177
3	0.0	0.1	0.4	0.8	1.5	2.4	3.4	4.6	6.0	10	14	24	38	54	74	96	122	150	182	217
4	0.0	0.1	0.4	1.0	1.7	2.7	3.9	5.3	7.0	11	16	28	43	63	85	111	141	174	210	250
5	0.0	0.1	0.5	1.1	1.9	3.0	4.4	6.0	7.8	12	18	31	49	70	95	124	157	194	235	280
10	0.0	0.2	0.7	1.5	2.8	4.3	6.2	8.4	11.0	18	25	44	69	99	135	176	222	275	332	395
15	0.1	0.2	0.8	1.9	3.4	5.3	7.6	10.3	13.4	21	30	54	84	121	165	215	272	336	407	484
20	0.1	0.2	1.0	2.2	3.9	6.1	8.7	11.9	15.5	25	35	62	97	140	190	248	314	388	469	559
25	0.1	0.3	1.1	2.4	4.3	6.8	9.8	13.3	17.3	28	39	69	108	156	212	277	351	434	525	624
30	0.1	0.3	1.2	2.6	4.8	7.4	10.7	14.5	19.0	30	43	76	119	171	233	304	385	475	574	684
35	0.1	0.3	1.3	2.9	5.1	8.0	11.5	15.7	20.5	33	46	82	128	185	251	328	415	513	620	738
40	0.1	0.3	1.4	3.1	5.5	8.6	12.3	16.8	21.9	35	49	88	137	197	268	351	444	548	663	789
45	0.1	0.4	1.5	3.3	5.8	9.1	13.1	17.8	23.2	37	52	93	145	209	285	372	470	581	703	836
50	0.1	0.4	1.5	3.4	6.1	9.6	13.8	18.7	24.5	39	55	98	153	220	300	392	496	612	740	881
55	0.1	0.4	1.6	3.6	6.4	10.0	14.4	19.6	25.7	41	58	103	160	231	314	411	520	641	776	924
60	0.1	0.4	1.7	3.8	6.7	10.5	15.1	20.5	26.8	43	60	107	167	241	328	429	542	670	810	964
65	0.1	0.4	1.7	3.9	7.0	10.9	15.7	21.3	27.9	45	63	111	174	251	341	446	564	697	843	1003
70	0.1	0.5	1.8	4.1	7.2	11.3	16.3	22.1	28.9	46	65	116	181	260	354	463	585	723	874	1041
75	0.1	0.5	1.9	4.2	7.5	11.7	16.8	22.9	29.9	48	67	120	187	269	366	479	606	748	905	1077
80	0.1	0.5	1.9	4.3	7.7	12.1	17.4	23.6	30.9	50	70	124	193	278	378	494	625	772	934	1112
85	0.1	0.5	2.0	4.5	8.0	12.4	17.9	24.4	31.6	51	72	127	199	285	390	509	644	795	962	1145
90	0.1	0.5	2.0	4.6	8.2	12.8	18.4	25.1	32.7	53	74	131	204	294	401	524	663	818	990	1178
95	0.1	0.5	2.1	4.7	8.4	13.1	18.9	25.7	33.6	54	76	134	210	302	412	538	680	840	1016	1210
100	0.1	0.5	2.2	4.9	8.6	13.5	19.4	26.4	34.5	55	78	138	215	310	422	551	698	861	1042	1241
105	0.1	0.6	2.2	5.0	8.8	13.8	19.9	27.0	35.3	57	79	141	221	318	432	565	715	882	1068	1271
110	0.1	0.6	2.3	5.1	9.0	14.1	20.3	27.6	36.1	58	81	144	226	325	442	578	731	903	1092	1300

1 psi = 27.68" H₂O

discharge coefficient = 0.65

Air Temperature = 70 deg F

Airflow in CFM

Vacuum

Orifice Diameters - Inches

Vacuum " Hg	1/32	1/16	1/8	3/16	1/4	5/16	3/8	7/16	1/2	5/8	3/4	1	1-1/4	1-1/2	1-3/4	2.0	2-1/4	2-1/2	2-3/4	3
0.5	0.0	0.1	0.6	1.3	2.2	3.5	5.1	6.9	9	14	20	36	56	81	110	144	182	225	272	324
1	0.0	0.2	0.8	1.8	3.1	4.9	7.1	9.6	13	20	28	50	79	113	154	202	255	315	381	453
2	0.1	0.3	1.1	2.5	4.4	6.8	9.8	13.0	17	27	39	70	109	157	214	280	354	437	529	629
3	0.1	0.3	1.3	3.0	5.2	8.2	11.8	16.0	21	33	47	84	131	189	257	336	425	525	635	756
4	0.1	0.4	1.5	3.3	5.9	9.3	13.4	18.0	24	37	53	95	148	214	291	380	481	594	718	855
5	0.1	0.4	1.6	3.7	6.5	10.0	14.6	20.0	26	41	58	104	162	234	318	416	526	650	786	936
6	0.1	0.4	1.7	3.9	7.0	11.0	15.7	21.0	28	44	63	111	174	251	341	446	564	696	842	1002
7	0.1	0.5	1.8	4.1	7.3	11.0	16.5	22.0	29	46	66	118	184	264	360	470	595	735	889	1058
8	0.1	0.5	1.9	4.3	7.7	12.0	17.3	23.0	31	48	69	123	192	276	376	491	621	766	927	1104
9	0.1	0.5	2.0	4.5	7.9	12.0	17.8	24.0	32	50	71	127	198	285	388	507	642	792	959	1141
10	0.1	0.5	2.0	4.6	8.1	13.0	18.3	25.0	33	51	73	130	203	293	398	520	659	813	984	1171
11	0.1	0.5	2.1	4.7	8.3	13.0	18.7	25.0	33	52	76	133	207	298	406	530	671	829	1003	1193
12	0.1	0.5	2.1	4.7	8.4	13.0	18.9	26.0	34	52	76	134	210	302	412	538	680	840	1016	1210
13	0.1	0.5	2.1	4.8	8.5	13.0	19.1	26.0	34	53	76	135	212	305	415	542	686	847	1025	1219
14	0.1	0.5	2.1	4.8	8.5	13.0	19.1	26.0	34	53	76	136	212	306	416	544	688	849	1028	1223
15	0.1	0.5	2.1	4.8	8.5	13.0	19.1	26.0	34	53	76	136	212	306	416	544	688	849	1028	1223

1" HG = 13.6" H₂O

discharge coefficient = 0.65

Air Temperature = 70 deg F

Airflow in CFM