

Contents

Item No.	Specifications	Selection Chart	Performance Curve	Pump Dimensions	Sectional View
CDU70/0-1/2HP CDU70/1-3/4HP CDU70/3-1½HP CDU70/5A-2HP CDU70/5B-2HP CDU120/1-1HP CDU120/3-1½HP CDU120/5-3HP CDU200/1-1½HP CDU200/3-3HP CDU200/5-3HP	303	305,312	306	318	319
CDX 70/076-3/4HP CDX 70/106-1HP CDX 70/156-1½HP CDX 120/106-1HP CDX 120/156-1½HP CDX 120/206-2HP CDX 200/156-1½HP CDX 200/206-2HP CDX 200/306-3HP	304	314	315	320	321

***Note:** Model CDU NSF/ANSI 61 Annex G listed



Model CDU

EBARA Stainless Steel Centrifugal Pumps

Model Designation

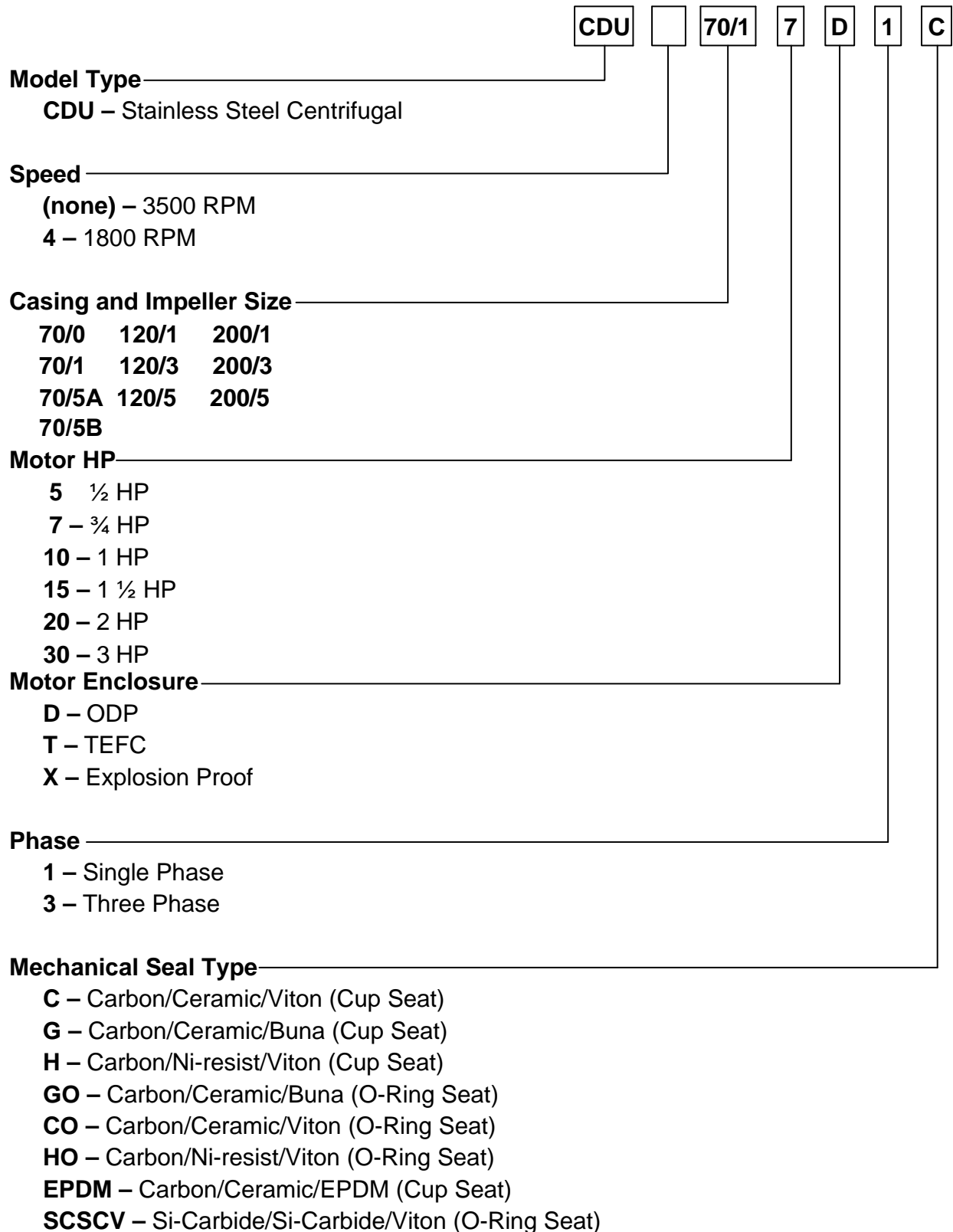

Model CDX/CDXM

EBARA Stainless Steel Centrifugal Pumps

Model Designation

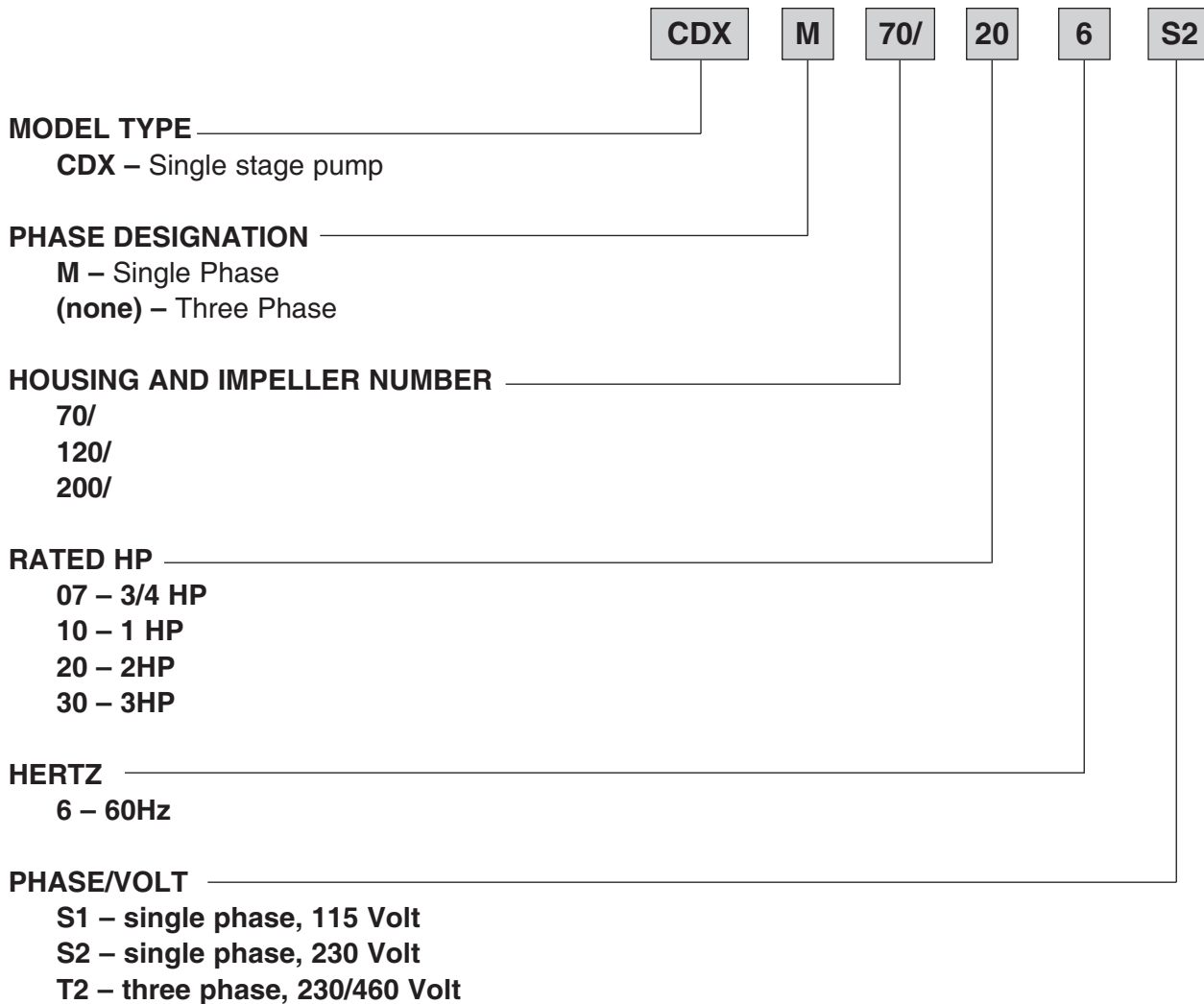

**Model CDU
Specifications**

EBARA Stainless Steel Centrifugal Pumps

	Standard	Optional
Size		
Suction	CDU70 – 1¼" NPT thread CDU120 – 1¼" NPT thread CDU200 – 1½" NPT thread	
Discharge	1" NPT thread	
Range of HP	½ HP to 3 HP	
Range of Performance		
Capacity	5.5 to 95 GPM at 3450 RPM	
Head	26 to 144 feet at 3450 RPM	
Liquid handled		
Type of liquid	Water	
Temperature	212°F (100°C)	Max. 250°F (121°C) with optional high temperature seal
Max. working pressure	125 PSI (9 Bar)	
Materials		
Casing	304L Stainless Steel	
Impeller (closed type)	304L Stainless Steel	
Shaft	Stainless Steel	
Bracket	Aluminum	
Shaft Seal	Mechanical Seal – Type 21	High temperature version Mild chemical version
Bearing	Ball Bearing	
Direction of Rotation	Clockwise when viewed from motor end	
Motor		
Type	NEMA 56J Frame	
Speed	60 Hz, 3450 RPM (2 poles)	
Single Phase	TEFC – ½ HP to 3 HP ODP – ½ HP to 3 HP, 115/230V	Explosion proof – consult factory Washdown duty – consult factory
Three Phase	TEFC – ½ HP to 3 HP ODP – ½ HP to 3 HP, 208-230/460V	
Motor Protection	Built-in overload protection (single phase)	

Specifications

	Standard	Optional
Size Suction Discharge	1 1/4" NPT Thread 1 1/2" NPT Thread 1" NPT Thread	
Range of HP	3/4 HP to 3 HP	
Range of Performance Capacity Head	5.5 to 68 GPM at 3600 RPM 40 to 130 feet at 3600 RPM	
Liquid handled Type of liquid Temperature Working pressure	Clean water Maximum: 140°F (60°C) Maximum: 116 PSI	
Materials Casing Impeller (closed type) Shaft Bracket Shaft Seal	304 Stainless Steel 304 Stainless Steel 303 Stainless Steel Aluminum Mechanical Seal Carbon/Ceramic/NBR	Consult factory for additional seal options
Direction of Rotation	Clockwise when viewed from motor end	
Motor Type Speed Single Phase Three Phase Motor Protection Bearing	TEFC/IP55 60 Hz, 3600 RPM (2 poles) 230V 230/460V Built-in overload protection (single phase) Sealed Ball Bearing	



Model CDU
Selection Chart

EBARA Stainless Steel Centrifugal Pumps

Nominal Speed 3450 RPM

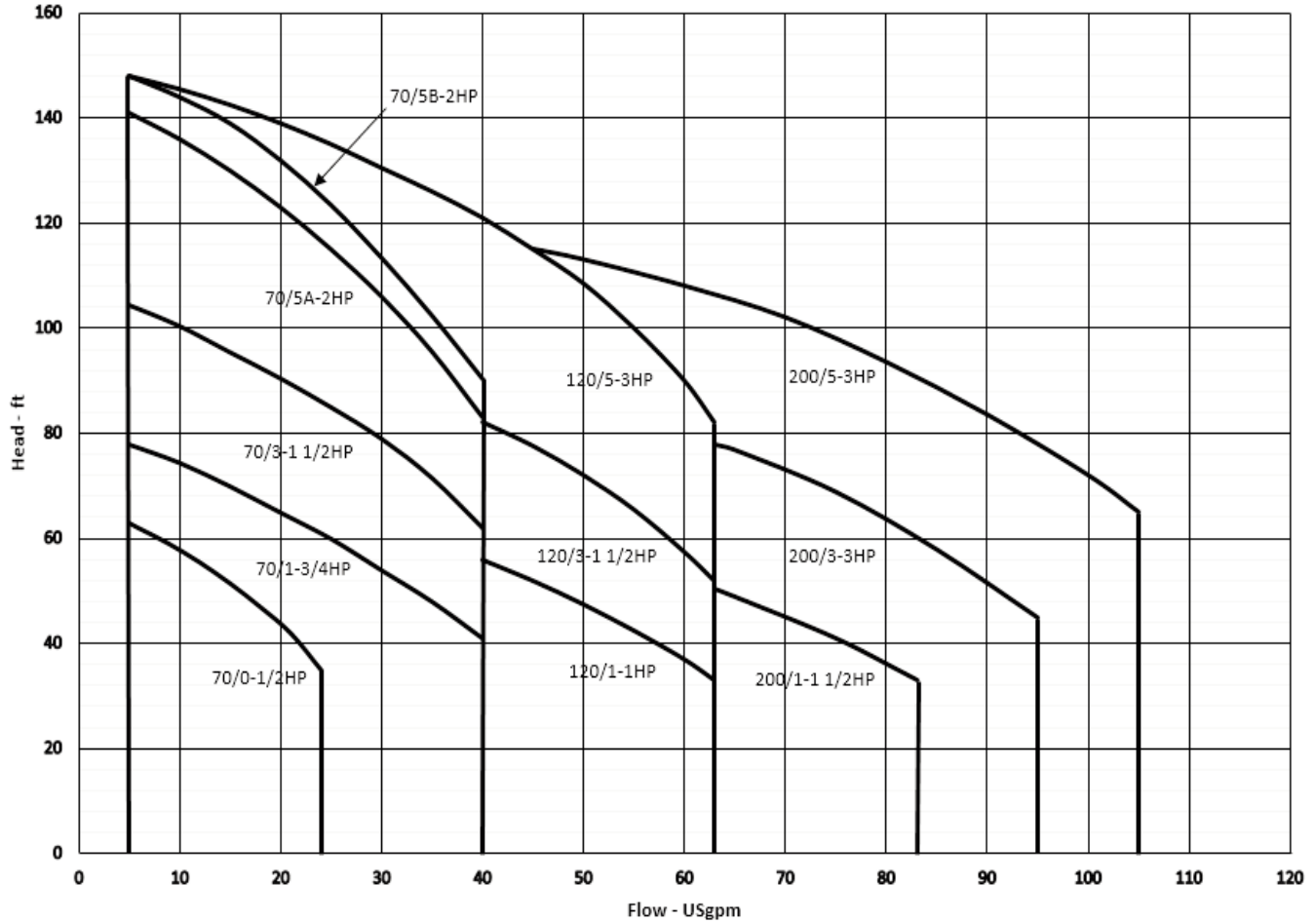

Model CDU

EBARA Stainless Steel Centrifugal Pumps

Performance Curves

CDU70/0-1/2 HP

Nominal Speed: 3450 RPM

Size: 1 x 1 1/4 x 4 1/2

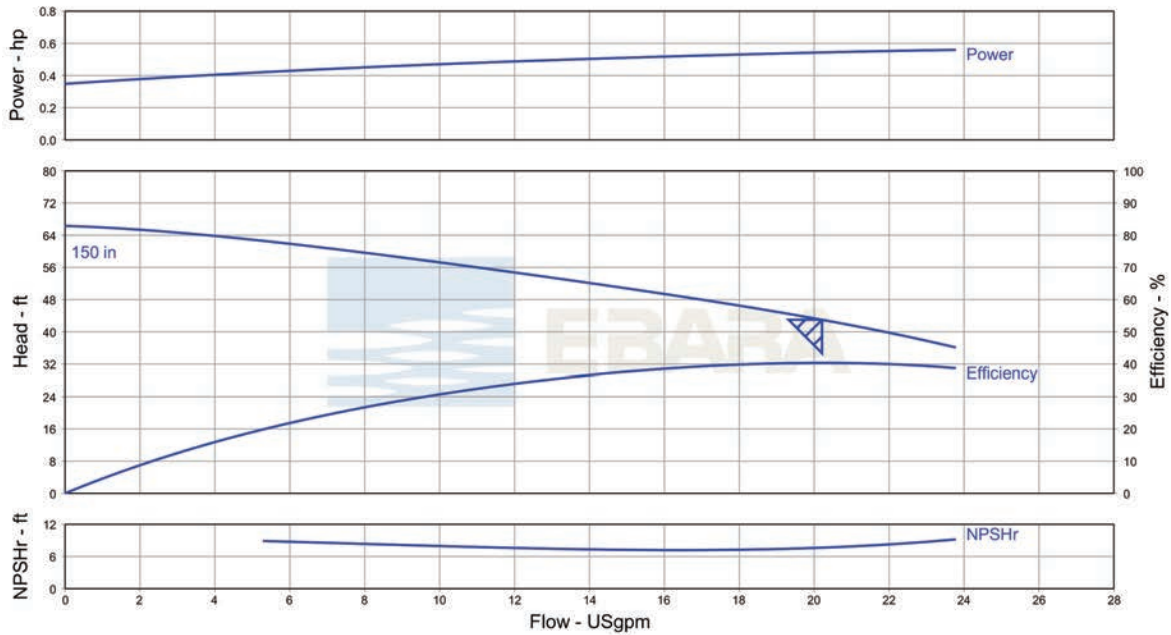

Item number	: 001	Product Description	: CDU70/0-1/2HP	Flow, rated	: 20.21 USgpm
Service	:	Stages	: 1	Head, rated	: 42.98 ft
Quantity	: 1	Speed	: 3450 rpm	NPSH required	: 7.64 ft
Quote number	: 831041	Based on curve number	: CD-C610-9309	Fluid density	: 1.000 / 1.000 SG
Date last saved	: 03 Aug 2018 8:37 AM	Efficiency	: 40.35 %	Viscosity	: 1.00 cP
		Power, rated	: 0.54 hp	Cq/Ch/Ce/Cn [ANSI/HI 9.6.7-2010]	: 1.00 / 1.00 / 1.00 / 1.00

CDU70/1-3/4 HP

Nominal Speed: 3450 RPM

Size: 1 x 1 1/4 x 4 1/2

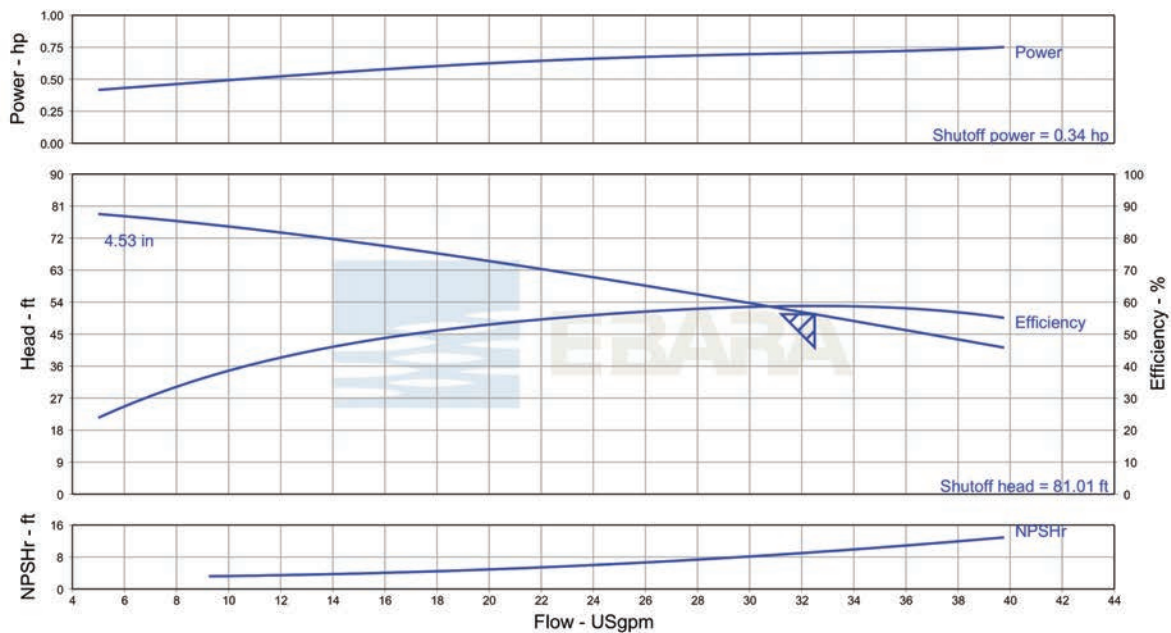

Item number	: 001	Product Description	: CDU70/1-3/4HP	Flow, rated	: 32.50 USgpm
Service	:	Stages	: 1	Head, rated	: 50.59 ft
Quantity	: 1	Speed	: 3450 rpm	NPSH required	: 9.19 ft
Quote number	: 831041	Based on curve number	: CD-C601-9309	Fluid density	: 1.000 / 1.000 SG
Date last saved	: 03 Aug 2018 8:56 AM	Efficiency	: 58.81 %	Viscosity	: 1.00 cP
		Power, rated	: 0.71 hp	Cq/Ch/Ce/Cn [ANSI/HI 9.6.7-2010]	: 1.00 / 1.00 / 1.00 / 1.00

Model CDU

EBARA Stainless Steel Centrifugal Pumps

Performance Curves

CDU70/3-1½ HP

Nominal Speed: 3450 RPM

Size: 1 x 1¼ x 5³/₁₆

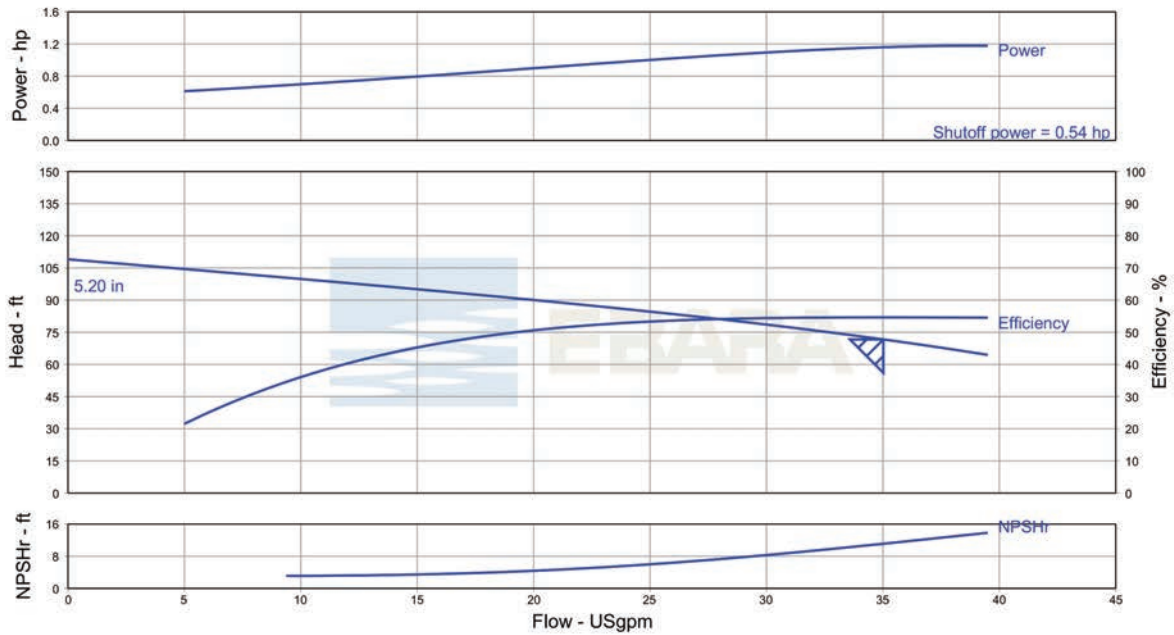

Item number	: 001	Product Description	: CDU70/3-1.5HP	Flow, rated	: 35.02 USGpm
Service	:	Stages	: 1	Head, rated	: 71.66 ft
Quantity	: 1	Speed	: 3450 rpm	NPSH required	: 11.10 ft
Quote number	: 831041	Based on curve number	: CD-C602-9309	Fluid density	: 1.000 / 1.000 SG
Date last saved	: 03 Aug 2018 8:57 AM	Efficiency	: 54.62 %	Viscosity	: 1.00 cP
		Power, rated	: 1.16 hp	Cq/Ch/Ce/Cn [ANSI/HI 9.6.7-2010]	: 1.00 / 1.00 / 1.00 / 1.00

CDU70/5A- 2 HP

Nominal Speed: 3450 RPM

Size: 1 x 1¼ x 6

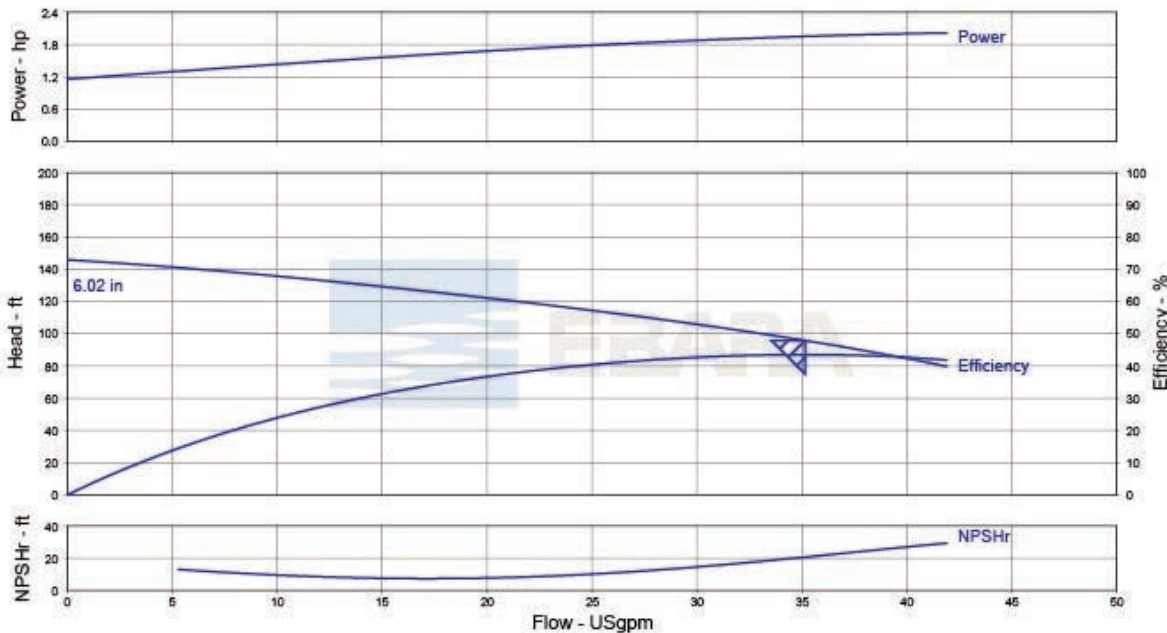

Item number	: 001	Product Description	: CDU70/5A-2HP	Flow, rated	: 35.15 USGpm
Service	:	Stages	: 1	Head, rated	: 95.77 ft
Quantity	: 1	Speed	: 3450 rpm	NPSH required	: 20.71 ft
Quote number	: 831041	Based on curve number	: CD-C803-9309-A	Fluid density	: 1.000 / 1.000 SG
Date last saved	: 03 Aug 2018 8:59 AM	Efficiency	: 43.51 %	Viscosity	: 1.00 cP
		Power, rated	: 1.95 hp	Cq/Ch/Ce/Cn [ANSI/HI 9.6.7-2010]	: 1.00 / 1.00 / 1.00 / 1.00



Model CDU

EBARA Stainless Steel Centrifugal Pumps

Performance Curves

CDU70/5B-2HP

Nominal Speed: 3450 RPM

Size: 1 x 1¹/₄ x 6³/₁₆

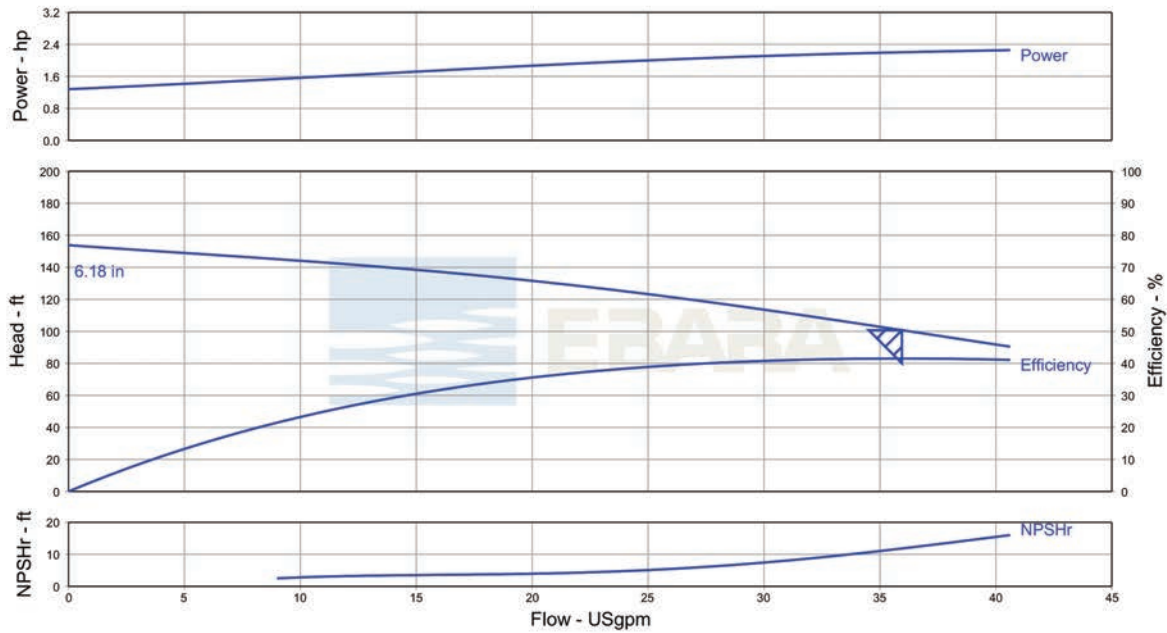

Item number	: 001	Product Description	: CDU70/5B-2HP	Flow, rated	: 35.95 USgpm
Service	:	Stages	: 1	Head, rated	: 100.8 ft
Quantity	: 1	Speed	: 3450 rpm	NPSH required	: 11.83 ft
Quote number	: 831041	Based on curve number	: CD-C603-9309-B	Fluid density	: 1.000 / 1.000 SG
Date last saved	: 03 Aug 2018 9:00 AM	Efficiency	: 41.51 %	Viscosity	: 1.00 cP
		Power, rated	: 2.20 hp	Cq/Ch/Ce/Cn [ANSI/HI 9.6.7-2010]	: 1.00 / 1.00 / 1.00 / 1.00

CDU120/1 1 HP

Nominal Speed: 3450 RPM

Size: 1 x 1¹/₄ x 4¹/₂

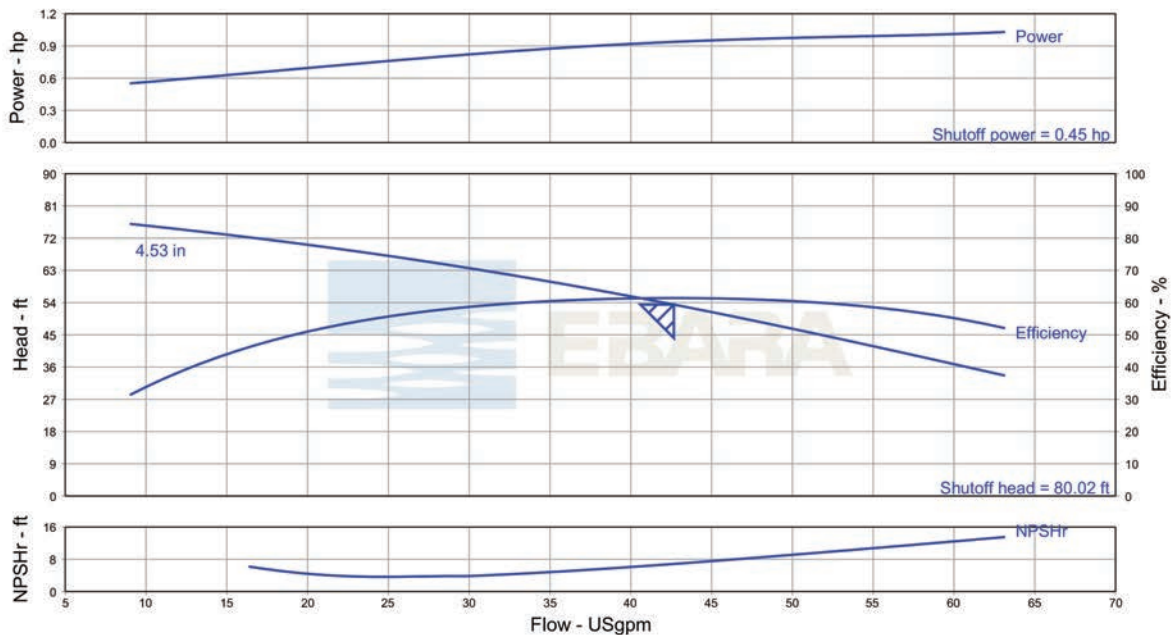

Item number	: 001	Product Description	: CDU120/1-1HP	Flow, rated	: 42.66 USgpm
Service	:	Stages	: 1	Head, rated	: 53.45 ft
Quantity	: 1	Speed	: 3450 rpm	NPSH required	: 6.84 ft
Quote number	: 831041	Based on curve number	: CD-C604-9309	Fluid density	: 1.000 / 1.000 SG
Date last saved	: 03 Aug 2018 9:01 AM	Efficiency	: 61.40 %	Viscosity	: 1.00 cP
		Power, rated	: 0.94 hp	Cq/Ch/Ce/Cn [ANSI/HI 9.6.7-2010]	: 1.00 / 1.00 / 1.00 / 1.00



Model CDU

EBARA Stainless Steel Centrifugal Pumps

Performance Curves

CDU120/3-1¹/₂ HP

Nominal Speed: 3450 RPM

Size: 1 x 1¹/₄ x 5³/₁₆

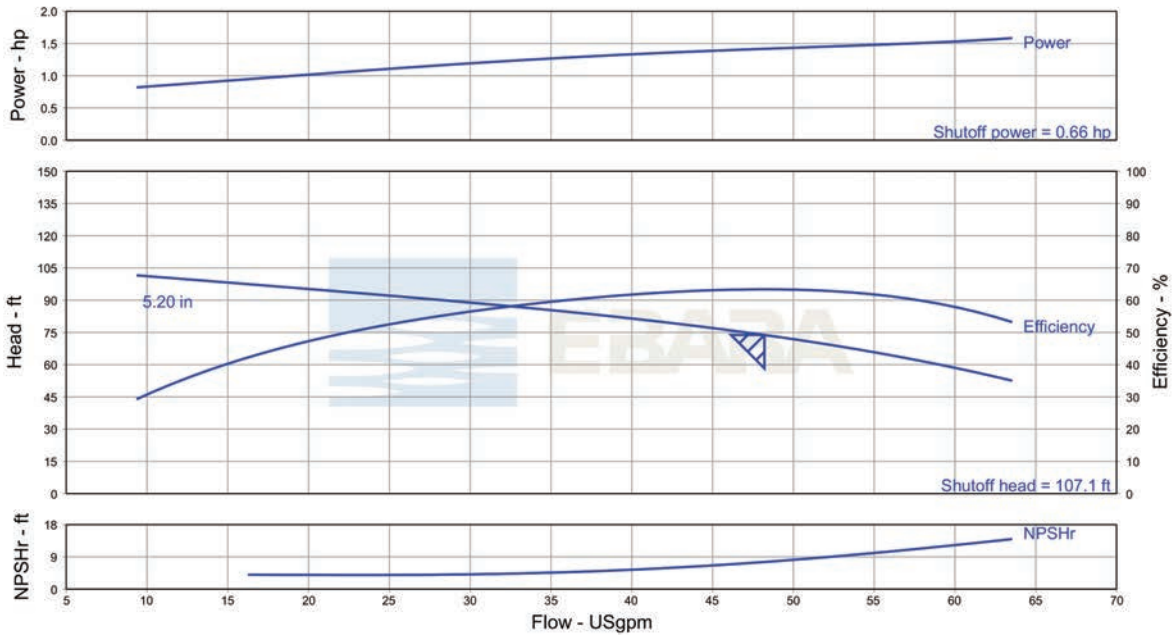

Item number	: 001	Product Description	: CDU120/3-1.5HP	Flow, rated	: 48.21 USgpm
Service	:	Stages	: 1	Head, rated	: 73.81 ft
Quantity	: 1	Speed	: 3450 rpm	NPSH required	: 7.57 ft
Quote number	: 831041	Based on curve number	: CD-C605-9309	Fluid density	: 1.000 / 1.000 SG
Date last saved	: 03 Aug 2018 9:02 AM	Efficiency	: 63.37 %	Viscosity	: 1.00 cP
		Power, rated	: 1.42 hp	Cq/Ch/Ce/Cn [ANSI/HI 9.6.7-2010]	: 1.00 / 1.00 / 1.00 / 1.00

CDU120/5- 3HP

Nominal Speed: 3450 RPM

Size: 1 x 1¹/₄ x 6³/₁₆

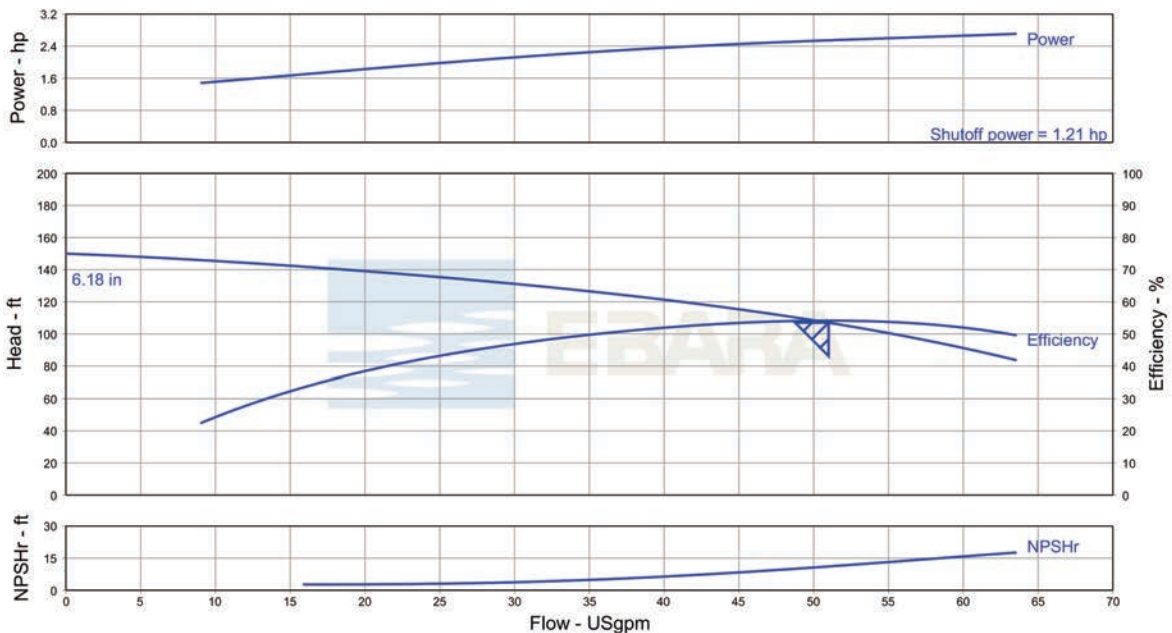

Item number	: 001	Product Description	: CDU120/5-3HP	Flow, rated	: 50.99 USgpm
Service	:	Stages	: 1	Head, rated	: 107.0 ft
Quantity	: 1	Speed	: 3450 rpm	NPSH required	: 11.11 ft
Quote number	: 831041	Based on curve number	: CD-C606-9309	Fluid density	: 1.000 / 1.000 SG
Date last saved	: 03 Aug 2018 9:03 AM	Efficiency	: 54.14 %	Viscosity	: 1.00 cP
		Power, rated	: 2.54 hp	Cq/Ch/Ce/Cn [ANSI/HI 9.6.7-2010]	: 1.00 / 1.00 / 1.00 / 1.00

Model CDU

EBARA Stainless Steel Centrifugal Pumps

Performance Curves

CDU200/1-1½ HP

Nominal Speed: 3450 RPM

Size: 1 x 1½ x 4½

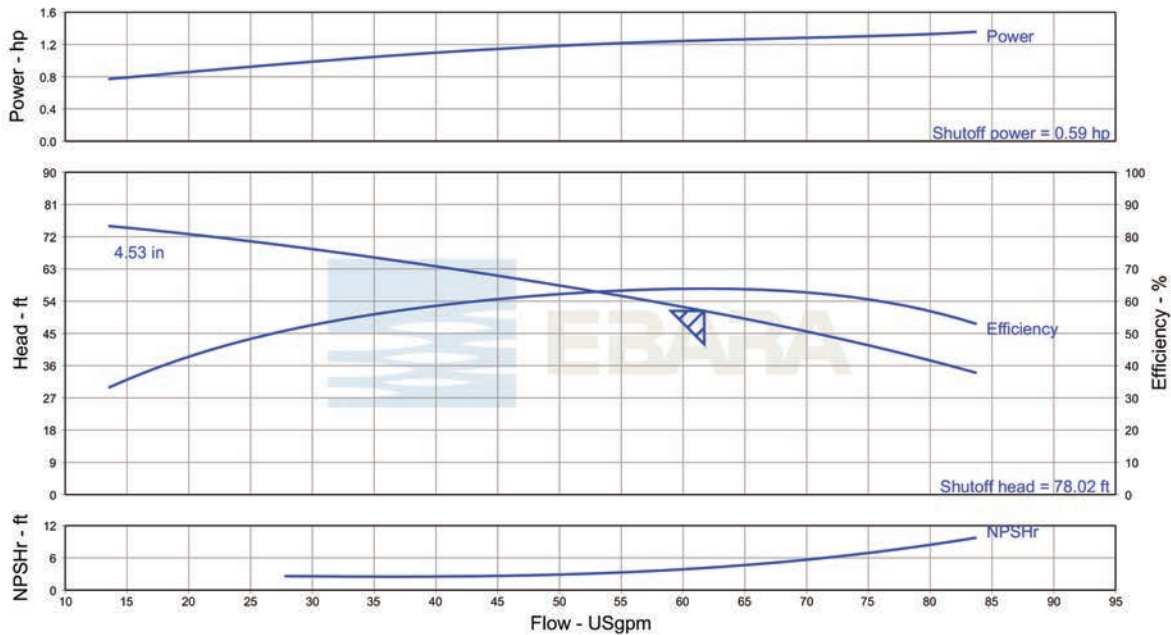

Item number	: 001	Product Description	: CDU200/1-1.5HP	Flow, rated	: 61.72 USgpm
Service	:	Stages	: 1	Head, rated	: 51.28 ft
Quantity	: 1	Speed	: 3450 rpm	NPSH required	: 4.11 ft
Quote number	: 831041	Based on curve number	: CD-C607-9309	Fluid density	: 1.000 / 1.000 SG
Date last saved	: 03 Aug 2018 9:03 AM	Efficiency	: 63.88 %	Viscosity	: 1.00 cP
		Power, rated	: 1.25 hp	Cq/Ch/Ce/Cn [ANSI/HI 9.6.7-2010]	: 1.00 / 1.00 / 1.00 / 1.00

CDU200/3-3 HP

Nominal Speed: 3450 RPM

Size: 1 x 1½ x 5³/₁₆

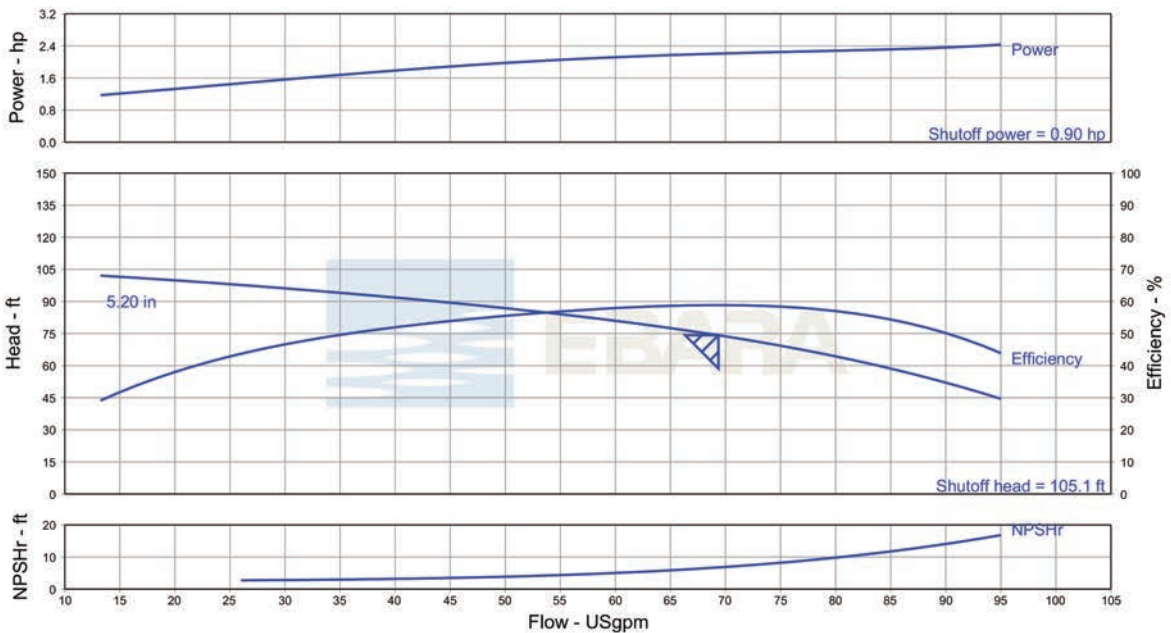

Item number	: 001	Product Description	: CDU200/3-3HP	Flow, rated	: 69.36 USgpm
Service	:	Stages	: 1	Head, rated	: 74.19 ft
Quantity	: 1	Speed	: 3450 rpm	NPSH required	: 6.75 ft
Quote number	: 831041	Based on curve number	: CD-C608-9309	Fluid density	: 1.000 / 1.000 SG
Date last saved	: 03 Aug 2018 9:04 AM	Efficiency	: 58.85 %	Viscosity	: 1.00 cP
		Power, rated	: 2.21 hp	Cq/Ch/Ce/Cn [ANSI/HI 9.6.7-2010]	: 1.00 / 1.00 / 1.00 / 1.00

Model CDU

EBARA Stainless Steel Centrifugal Pumps

Performance Curves

CDU200/5-3HP

Nominal Speed: 3450 RPM

Size: 1 x 1½ x 5¹¹/₁₆

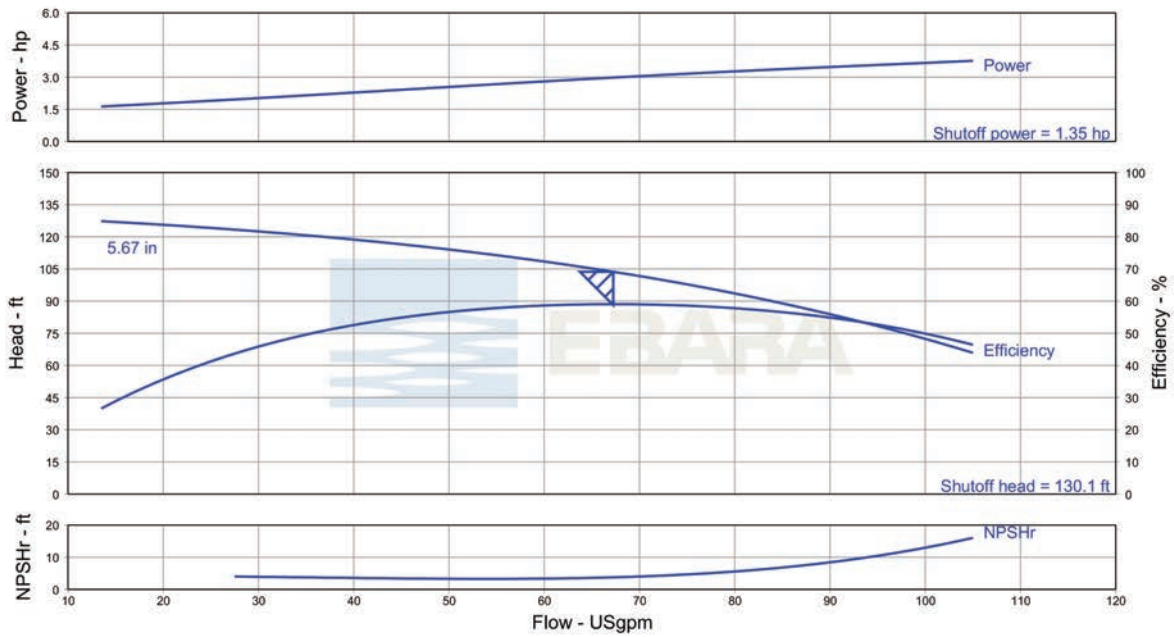

Item number	: 001	Product Description	: CDU200/5-3HP	Flow, rated	: 67.25 USgpm
Service	:	Stages	: 1	Head, rated	: 103.7 ft
Quantity	: 1	Speed	: 3450 rpm	NPSH required	: 3.74 ft
Quote number	: 831041	Based on curve number	: CD-C609-9309	Fluid density	: 1.000 / 1.000 SG
Date last saved	: 03 Aug 2018 9:05 AM	Efficiency	: 59.06 %	Viscosity	: 1.00 cP
		Power, rated	: 2.98 hp	Cq/Ch/Ce/Cn [ANSI/HI 9.6.7-2010]	: 1.00 / 1.00 / 1.00 / 1.00



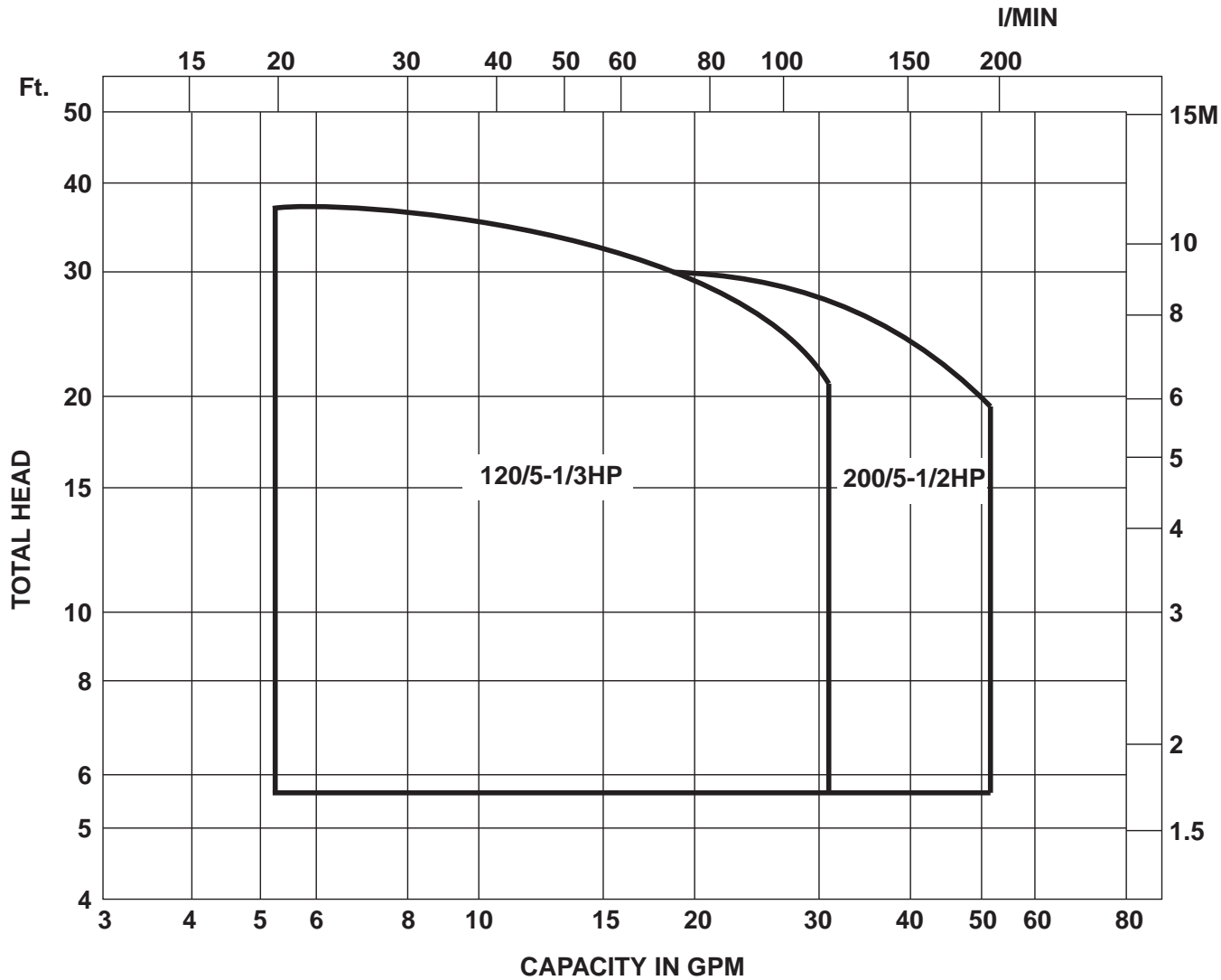

Model CDU
Performance Curves

EBARA Stainless Steel Centrifugal Pumps

CDU4 120/5-1/3 HP

Nominal Speed: 1725 RPM

Size: 1 x 1 1/4 x 6 3/16

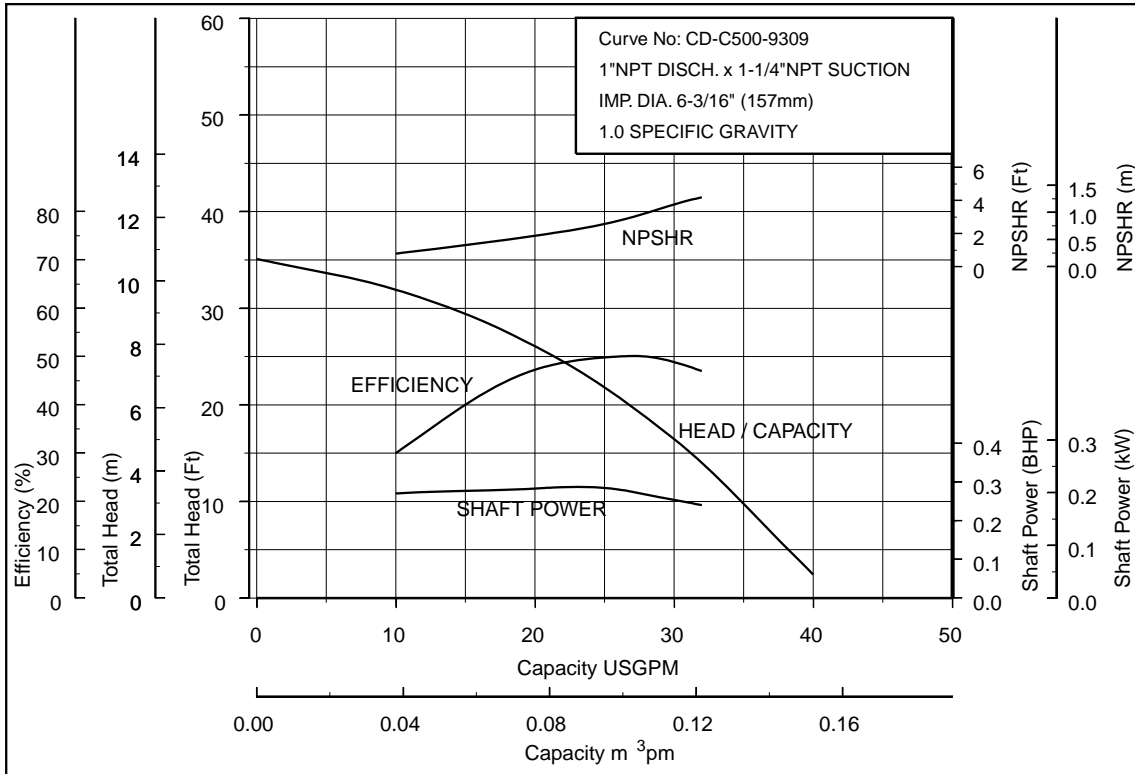

CDU4 200/5-1/2 HP

Nominal Speed: 1725 RPM

Size: 1 x 1 1/2 x 5 11/16

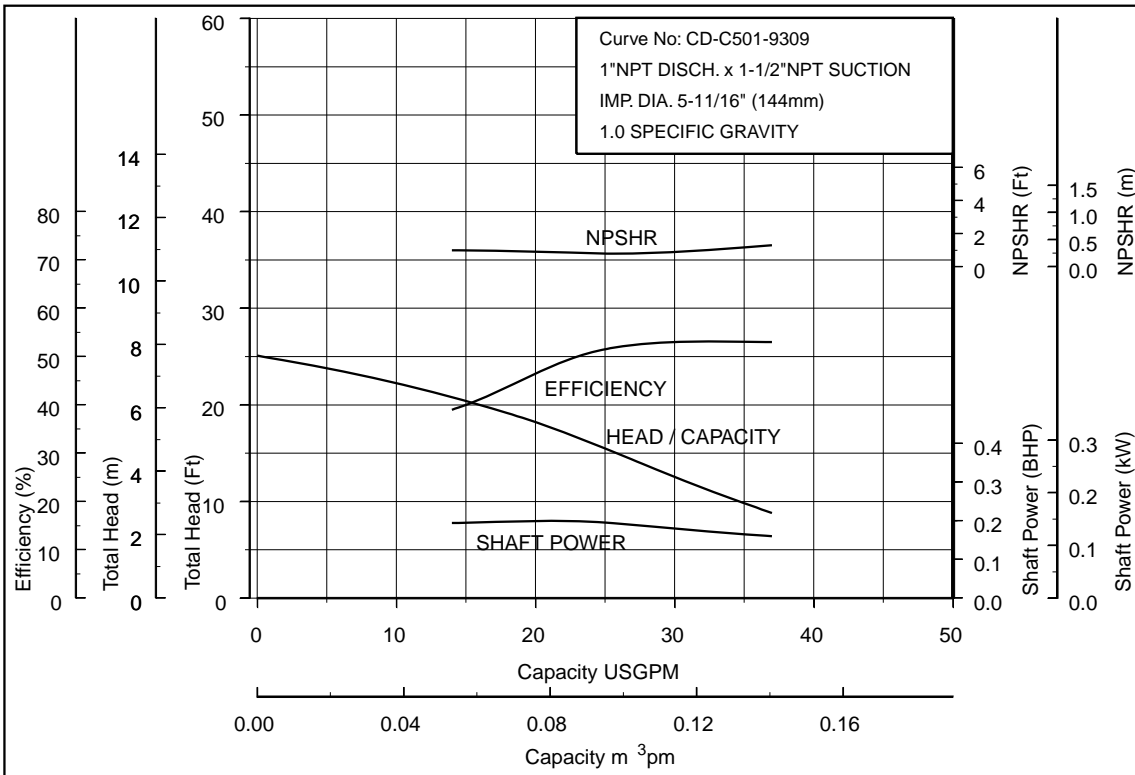

Selection Chart

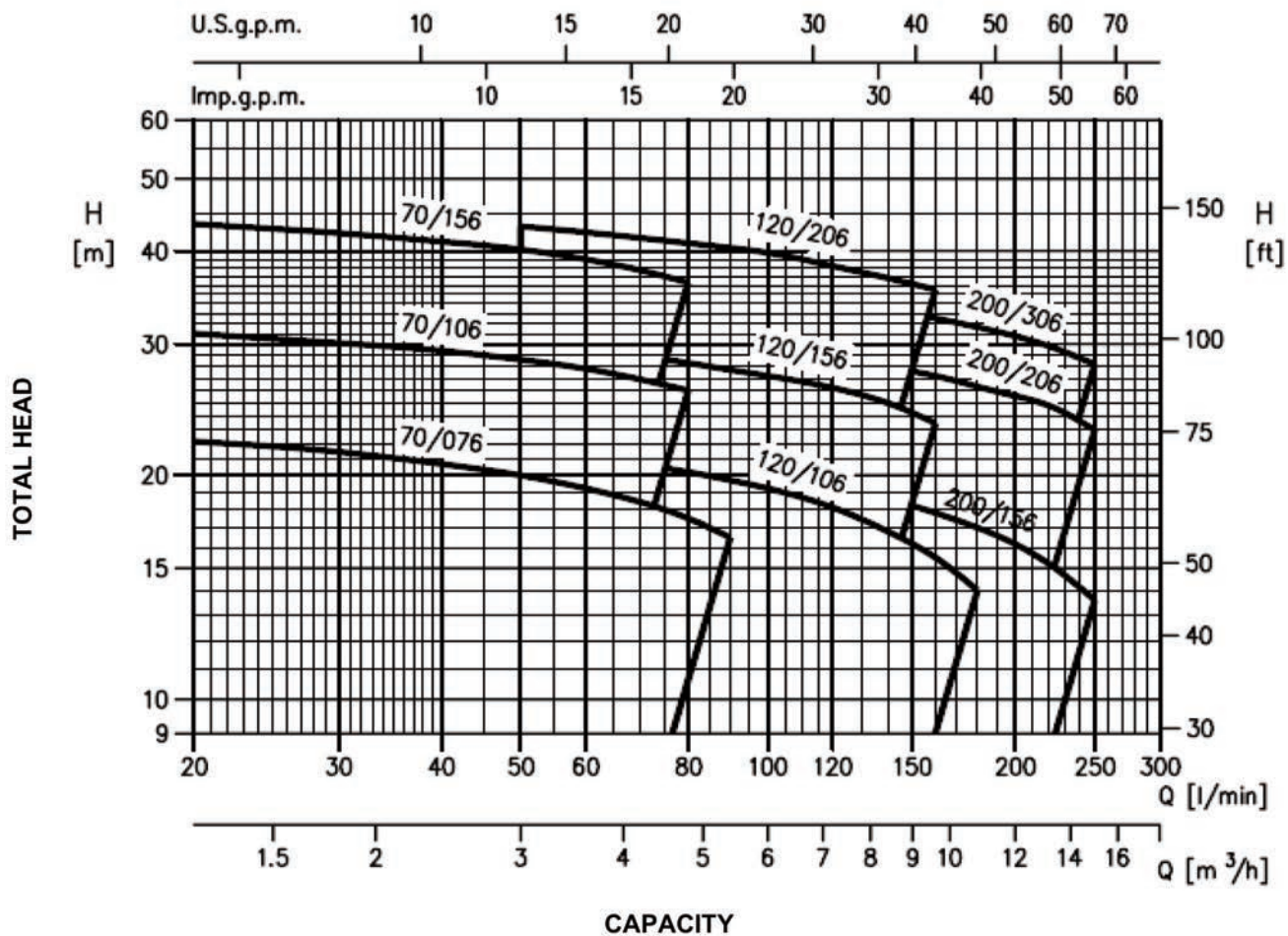

Performance Curves

CDX 70/076 (0.55 kW) - Impeller diameter = 115 mm
CDX 70/106 (0.75 kW) - Impeller diameter = 132 mm
CDX 70/156 (1.1 kW) - Impeller diameter = 157 mm

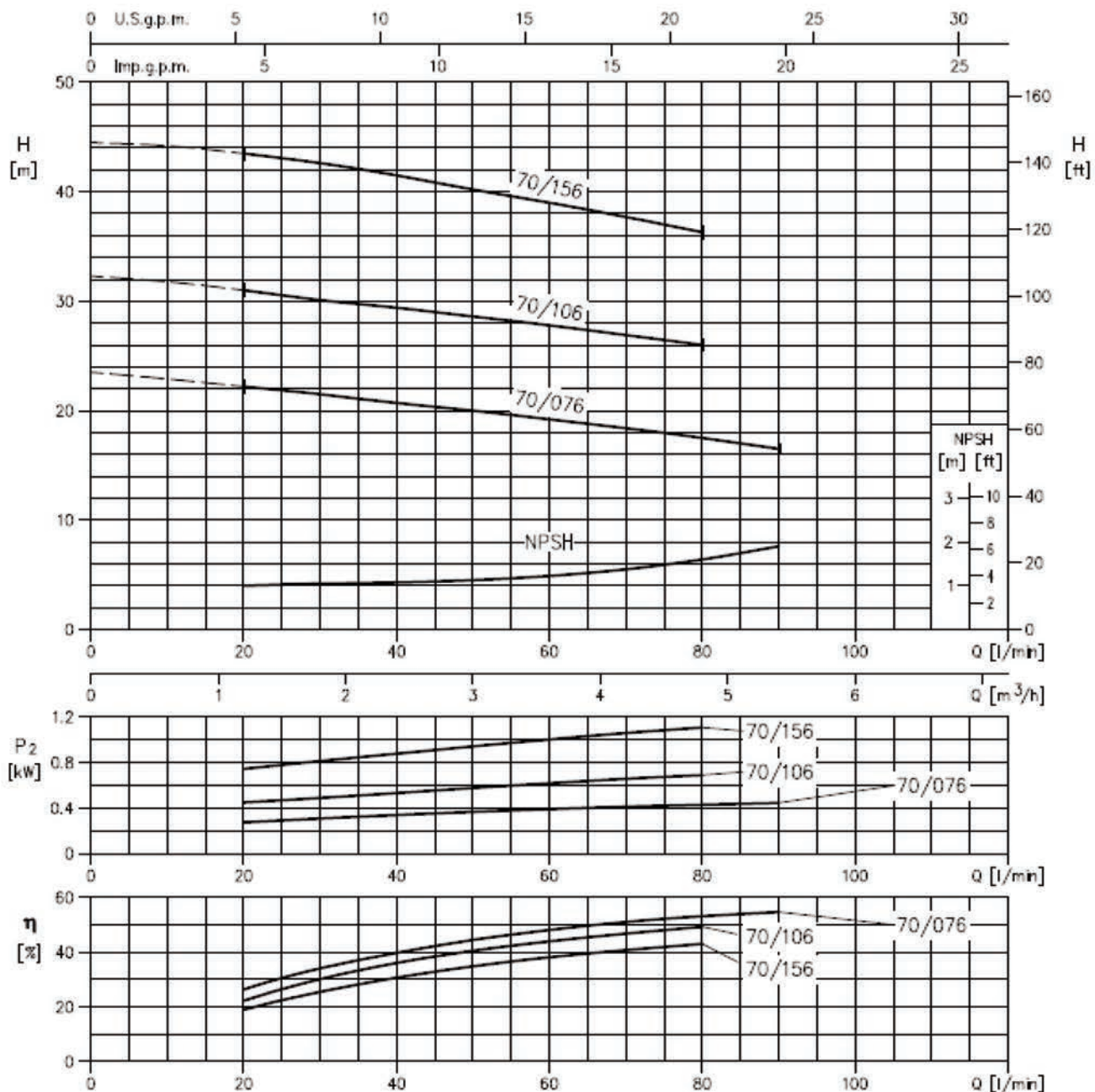

Rotation speed $\approx 3450 \text{ min}^{-1}$
 Test standard: ISO 9906 – Annex A

Performance Curves

CDX 120/106 (0.75 kW) - Impeller diameter = 115 mm
CDX 120/156 (1.1 kW) - Impeller diameter = 132 mm
CDX 120/206 (1.5 kW) - Impeller diameter = 157 mm

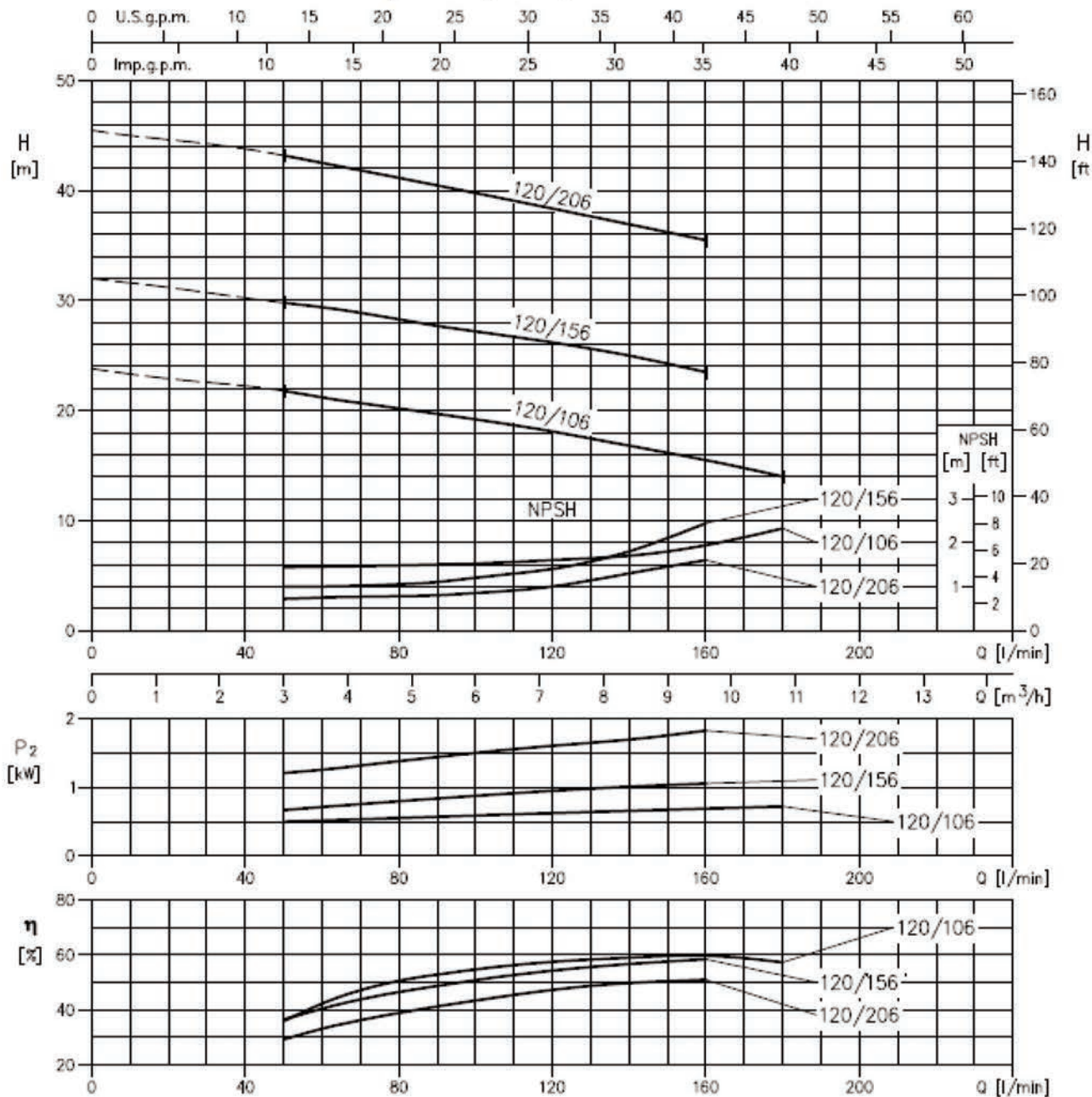

Rotation speed $\approx 3450 \text{ min}^{-1}$
 Test standard: ISO 9906 – Annex A

Performance Curves

CDX 200/156 (1.1 kW) - Impeller diameter = 115 mm

CDX 200/206 (1.5 kW) - Impeller diameter = 132 mm

CDX 200/306 (2.2 kW) - Impeller diameter = 144 mm

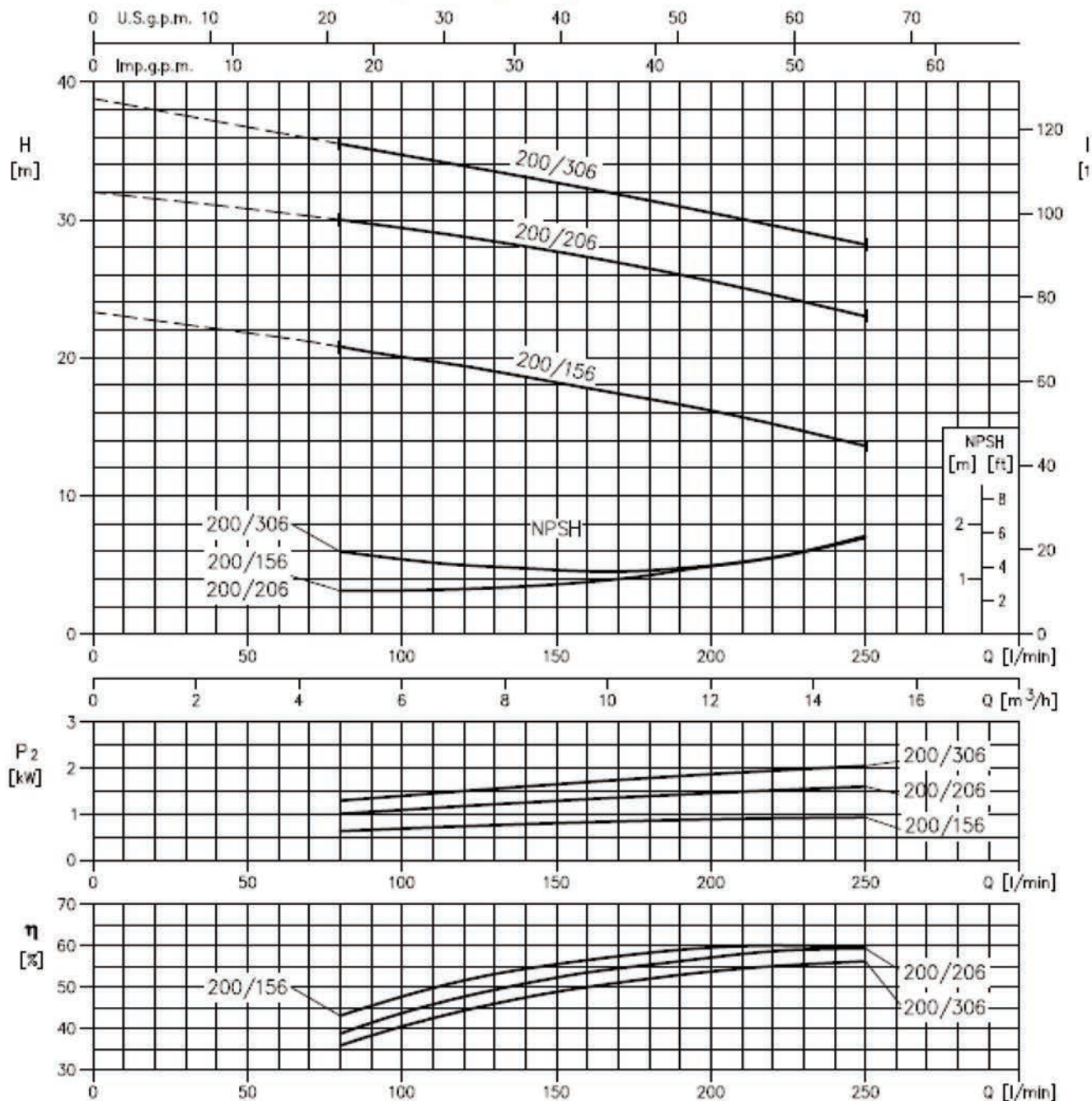

Rotation speed $\approx 3450 \text{ min}^{-1}$
 Test standard: ISO 9906 – Annex A

Model CDU

EBARA Stainless Steel Centrifugal Pumps

Pump Dimensions

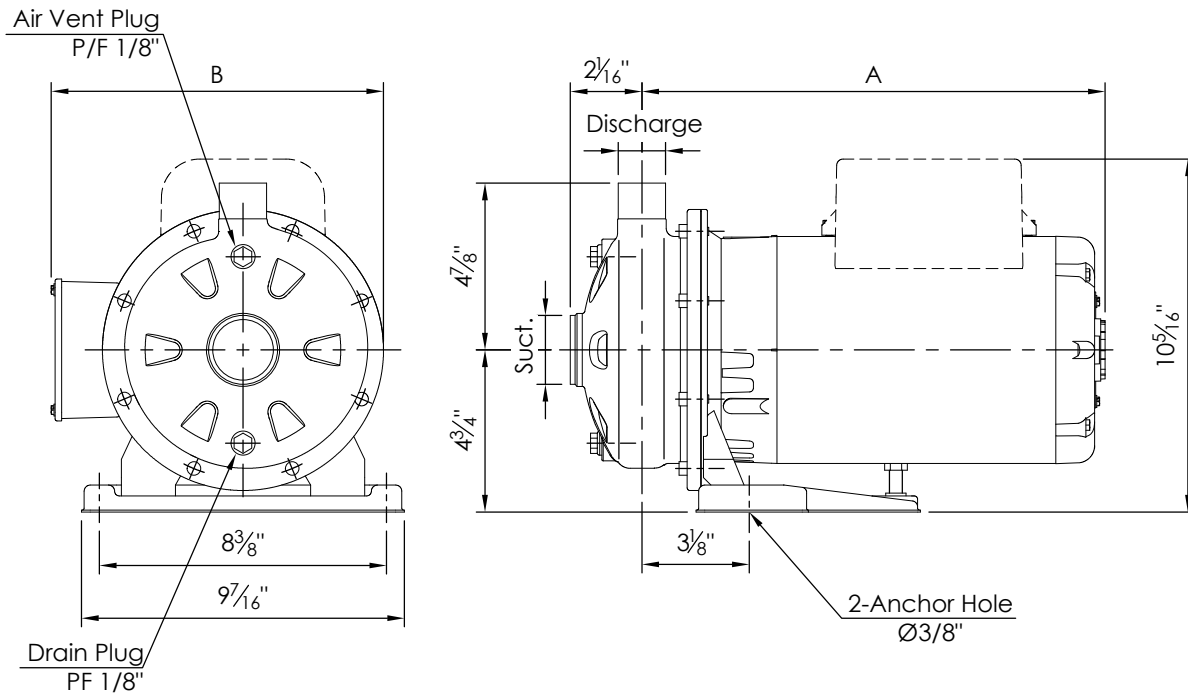

Model CDU, 2-Pole Motor

Model	Size	Pump Size – NPT (Inch)		Dimension (Inch)		Unit Weight (lbs.)			
		Suction	Discharge	A	B	Single Phase		Three Phase	
						ODP	TEFC	ODP	TEFC
CDU70/0-1/2HP	1 x 1 1/4 x 4 1/2	1 1/4	1	14 11/16	9 1/8	36	41	31	31
CDU70/1-3/4HP	1 x 1 1/4 x 4 1/2	1 1/4	1	15 3/16	9 1/8	36	41	31	31
CDU70/3-1 1/2HP	1 x 1 1/4 x 5 3/16	1 1/4	1	16 3/16	9 1/8	47	50	39	39
CDU70/5A-2HP	1 x 1 1/4 x 6 3/16	1 1/4	1	16 5/8	9 1/8	51	58	44	48
CDU70/5B-2HP	1 x 1 1/4 x 6 3/16	1 1/4	1	16 5/8	9 1/8	51	58	44	48
CDU120/1-1HP	1 x 1 1/4 x 4 1/2	1 1/4	1	15 11/16	9 1/8	41	46	33	32
CDU120/3-1 1/2HP	1 x 1 1/4 x 5 3/16	1 1/4	1	16 3/16	9 1/8	47	50	39	39
CDU120/5-3HP	1 x 1 1/4 x 6 3/16	1 1/4	1	17 3/8	9 1/8	59	66	51	60
CDU200/1-1 1/2HP	1 x 1 1/2 x 4 1/2	1 1/2	1	16 3/16	9 1/8	47	50	39	39
CDU200/3-3HP	1 x 1 1/2 x 5 3/16	1 1/2	1	17 3/8	9 1/8	58	65	50	59
CDU200/5-3HP	1 x 1 1/2 x 5 11/16	1 1/2	1	17 3/8	9 1/8	58	65	50	59

Model CDU, 4-Pole Motor

Model	Size	Pump Size – NPT (Inch)		Dimension (Inch)		Unit Weight (lbs.)			
		Suction	Discharge	A	B	Single Phase		Three Phase	
						ODP	TEFC	ODP	TEFC
CDU4120/5-1/3HP	1 x 1 1/4 x 6 3/16	1 1/4	1	13 11/16	9 5/16	32	31	31	30
CDU4200/5-1/2HP	1 x 1 1/2 x 5 11/16	1 1/2	1	14 11/16	9 5/16	35	31	31	31

Sectional View

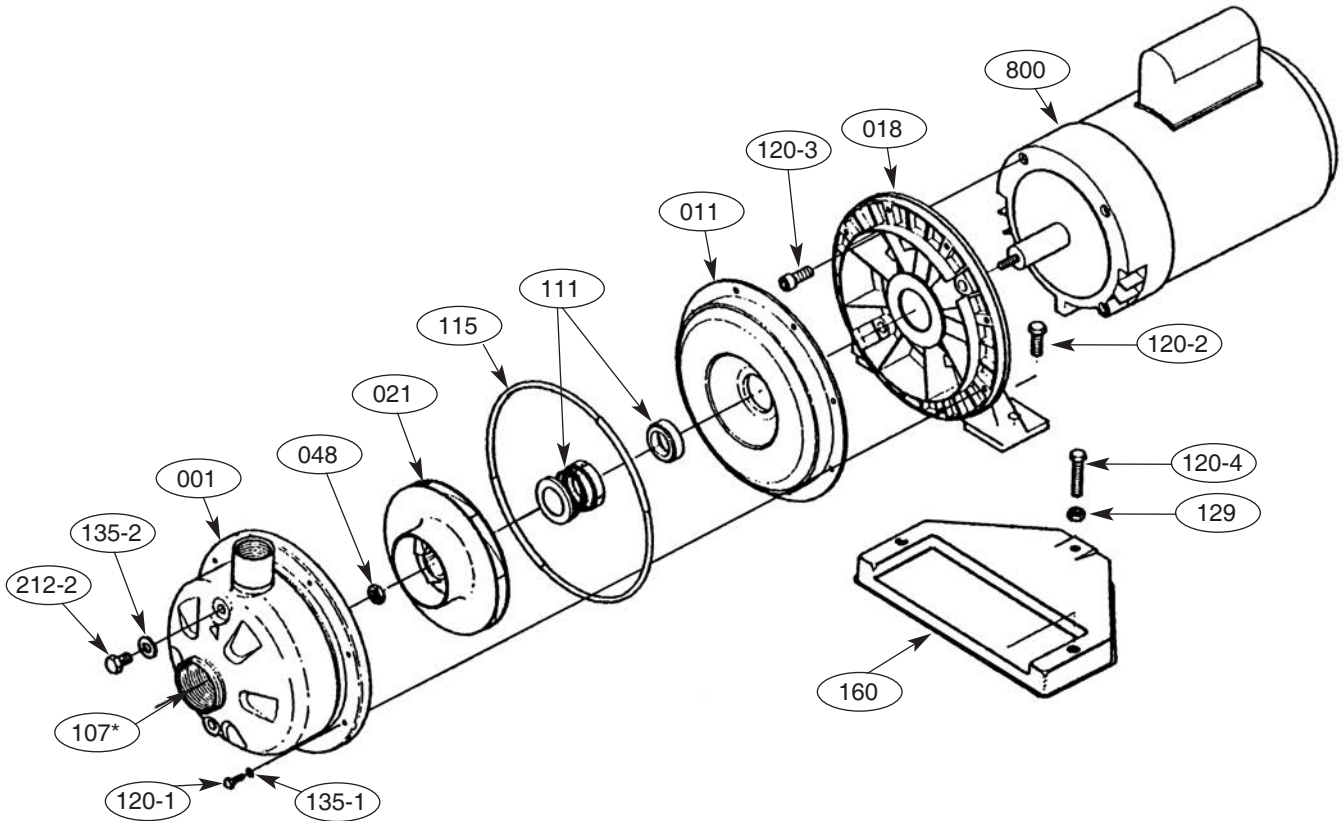

Part No.	Part Name	Material	No. for 1 Unit
001	Casing	304L Stainless	1
011	Casing cover	304L Stainless	1
018	Bracket	Aluminum	1
021	Impeller	304L Stainless	1
048	Impeller nut	304L Stainless	1
107*	Casing ring (*CDU 70 series only)	Viton	1
111	Mechanical seal	—	1
115	O-Ring	Viton	1
120-1	Bolt	304L Stainless	8
120-2	Bolt	304L Stainless	2
120-3	Bolt	304L Stainless	4
120-4	Bolt	304L Stainless	1
129	Nut	304L Stainless	1
135-1	Washer	304L Stainless	8
135-2	Washer	304L Stainless	2
160	Base	Steel	1
212-2	Plug	304L Stainless	2
800	Motor	—	1



Pump Dimensions

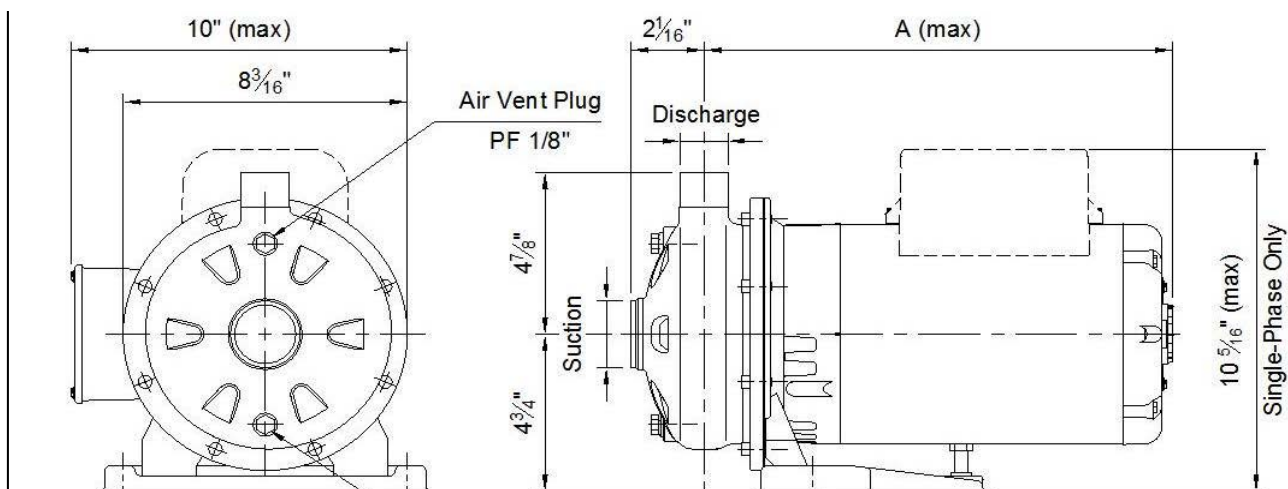

Dimensions: inch

Phase	Model	HP	A	B	C	H	H1	H2	H3 [3-]	M	M1	N	N1	R	V [3-]
Three	CDX 70/076	0.75	8 3/16	12 5/8	7 1/8	9 1/16	4 3/16	4 7/8	8 1/8	1 15/16	1 1/2	4 3/4	6 5/16	4 1/4	M16x1.5
	CDX 70/106	1	8 3/16	12 5/8	7 1/8	9 1/16	4 3/16	4 7/8	8 1/8	1 15/16	1 1/2	4 3/4	6 5/16	4 1/4	M16x1.5
	CDX 70/156	1.5	8 3/16	13 1/16	7 1/8	9 1/16	4 3/16	4 7/8	8 1/8	1 15/16	1 1/2	4 3/4	6 5/16	4 1/4	M16x1.5
	CDX 120/106	1	8 3/16	12 5/8	7 1/8	9 1/16	4 3/16	4 7/8	8 1/8	1 15/16	1 1/2	4 3/4	6 5/16	4 1/4	M16x1.5
	CDX 120/156	1.5	8 3/16	13 1/16	7 1/8	9 1/16	4 3/16	4 7/8	8 1/8	1 15/16	1 1/2	4 3/4	6 5/16	4 1/4	M16x1.5
	CDX 120/206	2	8 3/16	14 1/8	7 13/16	9 1/16	4 3/16	4 7/8	8 7/8	2 3/16	1 9/16	5 1/2	7 1/16	4 1/8	M20x1.5
	CDX 200/156	1.5	8 3/16	12 5/8	7 1/8	9 1/16	4 3/16	4 7/8	8 1/8	1 15/16	1 1/2	4 3/4	6 5/16	4 1/4	M16x1.5
	CDX 200/206	2	8 3/16	14 1/8	7 13/16	9 1/16	4 3/16	4 7/8	8 7/8	2 3/16	1 9/16	5 1/2	7 1/16	4 1/8	M20x1.5
CDX 200/306	3	9 1/8	14 1/8	7 13/16	9 13/16	4 5/8	5 3/16	9 5/16	2 3/16	1 9/16	5 1/2	7 1/16	4 1/8	M20x1.5	

Dimensions: mm

Phase	Model	HP	A	B	C	H	H1	H2	H3 [3-]	M	M1	N	N1	R	V [3-]
Three	CDX 70/076	0.75	208	320	181	229.5	106	123.5	207	50	38	120	160	108	M16x1.5
	CDX 70/106	1	208	320	181	229.5	106	123.5	207	50	38	120	160	108	M16x1.5
	CDX 70/156	1.5	208	332	181	229.5	106	123.5	207	50	38	120	160	108	M16x1.5
	CDX 120/106	1	208	320	181	229.5	106	123.5	207	50	38	120	160	108	M16x1.5
	CDX 120/156	1.5	208	332	181	229.5	106	123.5	207	50	38	120	160	108	M16x1.5
	CDX 120/206	2	208	359	198.5	229.5	106	123.5	225	55	40	140	180	105.5	M20x1.5
	CDX 200/156	1.5	208	320	181	229.5	106	123.5	207	50	38	120	160	108	M16x1.5
	CDX 200/206	2	208	359	198.5	229.5	106	123.5	225	55	40	140	180	105.5	M20x1.5
CDX 200/306	3	232	359	198.5	250	118	132	237	55	40	140	180	105.5	M20x1.5	

Dimensions: inch

Phase	Model	HP	A	B	C	H	H1	H2	H4 [1-]	M	M1	N	N1	R	T [1-]
Single	CDXM 70/076	0.75	8 3/16	12 5/8	7 1/8	9 1/16	4 3/16	4 7/8	8 1/2	1 15/16	1 1/2	4 3/4	6 5/16	4 1/4	PG 11
	CDXM 70/106	1	8 3/16	12 5/8	7 1/8	9 1/16	4 3/16	4 7/8	8 1/2	1 15/16	1 1/2	4 3/4	6 5/16	4 1/4	PG 11
	CDXM 70/156	1.5	8 3/16	12 5/8	7 1/8	9 1/16	4 3/16	4 7/8	8 1/2	1 15/16	1 1/2	4 3/4	6 5/16	4 1/4	PG 11
	CDXM 120/106	1	8 3/16	12 5/8	7 1/8	9 1/16	4 3/16	4 7/8	8 1/2	1 15/16	1 1/2	4 3/4	6 5/16	4 1/4	PG 11
	CDXM 120/156	1.5	8 3/16	12 5/8	7 1/8	9 1/16	4 3/16	4 7/8	8 1/2	1 15/16	1 1/2	4 3/4	6 5/16	4 1/4	PG 11
	CDXM 120/206	2	8 3/16	13 11/16	7 13/16	9 1/16	4 3/16	4 7/8	9 13/16	2 3/16	1 9/16	5 1/2	7 1/16	4 1/8	PG 13.5
	CDXM 200/156	1.5	8 3/16	12 5/8	7 1/8	9 1/16	4 3/16	4 7/8	8 1/2	1 15/16	1 1/2	4 3/4	6 5/16	4 1/4	PG 11
	CDXM 200/206	2	8 3/16	13 11/16	7 13/16	9 1/16	4 3/16	4 7/8	9 5/16	2 3/16	1 9/16	5 1/2	7 1/16	4 1/8	PG 13.5

Dimensions: mm

Phase	Model	HP	A	B	C	H	H1	H2	H4 [1-]	M	M1	N	N1	R	T [1-]
Single	CDXM 70/076	0.75	208	321	181	229.5	106	123.5	216	50	38	120	160	108	PG 11
	CDXM 70/106	1	208	321	181	229.5	106	123.5	216	50	38	120	160	108	PG 11
	CDXM 70/156	1.5	208	321	181	229.5	106	123.5	216	50	38	120	160	108	PG 11
	CDXM 120/106	1	208	321	181	229.5	106	123.5	216	50	38	120	160	108	PG 11
	CDXM 120/156	1.5	208	321	181	229.5	106	123.5	216	50	38	120	160	108	PG 11
	CDXM 120/206	2	208	347	198.5	229.5	106	123.5	249	55	40	140	180	105.5	PG 13.5
	CDXM 200/156	1.5	208	321	181	229.5	106	123.5	216	50	38	120	160	108	PG 11
	CDXM 200/206	2	208	347	198.5	229.5	106	123.5	237	55	40	140	180	105.5	PG 13.5



Sectional View

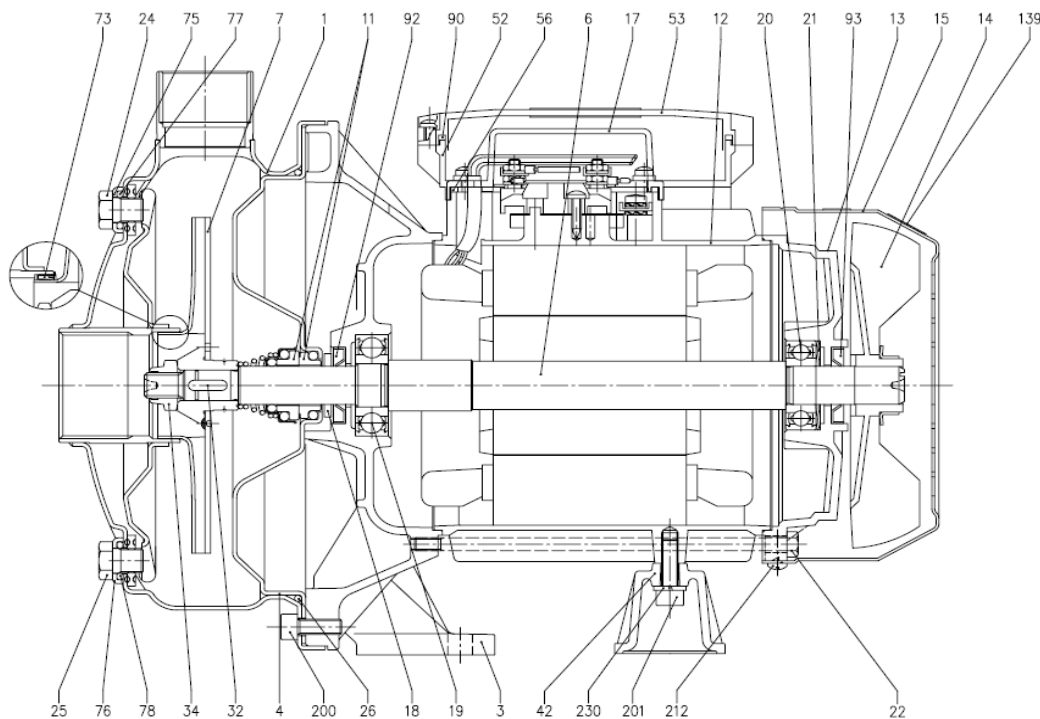

CDX/CDXM Parts

Ref.	Name	Material	QTY.	Ref.	Name	Material	QTY.
1	Casing	304 Stainless	1	25	Drain plug	303 Stainless	1
3	Motor Bracket	Alum.	1	26	O-ring	Viton	1
4	Casing cover	304 Stainless	1	32	Key	316 Stainless	1
6	Shaft with rotor	303 Stainless	1	34	Impeller nut	304 Stainless	1
7	Impeller	304 Stainless	1	42	Motor support	Alum.	1
11	Mechanical seal	Carbon/Ceramic	1	52	Terminal box (Single phase only)	ABS	1
12	Motor frame		1	53	Terminal box cover	ABS	1
13	Motor cover	Alum.	1	56	Box gasket	Viton	1
14	Fan	PA	1	73	Casing ring	304 Stainless	1
15	Fan cover	Steel	1	75	Washer	304 Stainless	1
16	Terminal board		1	76	Washer	304 Stainless	1
17	Terminal box cover (Three phase only)	Alum.	1	77	O-ring	Viton	1
18	Splash ring	Viton	1	78	O-ring	Viton	1
19	Pump side ball bearing		1	90	Terminal box cover gasket (Single phase)	Viton	1
20	Fan side ball bearing		1	92	Lip seal		1
21	Adjusting ring	Steel	1	93	Lip seal		1
22	Tie rod	Steel	4	110	Protector (Single phase only)		1
23	Capacitor (Single phase only)		1	200	Screw		8
24	Priming plug	303 Stainless	1				



Electrical Data

3/4 to 1 HP, Single Phase, 115V

Hz	Poles	Phase	Output (HP)	Voltage (V)	Applicable Model
60	2	Single	0.75-1	115	CDXM70

Name-Plate Rating	MOTOR MODEL		70/076	70/106
	Output	HP	0.75	1
		KW	0.55	0.75
	Phase		1	1
	Poles		2	2
	Volts		115	115
	Amperes		7.5	9.4
	Speed		3430	3450
	Insulation Class		F	F
Capacity of Capacitor μF		Start	-	-
		Run	45	60
No Load Test	Amperes		3.22	6.23
	Watts		230	354
Resistance at 20°C	Ohms		1.357	0.921
100% Load	Current		7.7	9.6
	Efficiency		65.0	66.1
	Power Factor		97.2	89.2
	Speed		3449	3445
Locked Rotor Torque			0.40	0.68
Start Current			28.1	40.94
Number Starts per Hour			30	
Voltage Tolerance			±6	



Model CDX/CDXM

EBARA Stainless Steel Centrifugal Pumps

Electrical Data

3/4 to 2 HP, Single Phase, 230V

Hz	Poles	Phase	Output (HP)	Voltage (V)	Applicable Model
60	2	Single	0.75-2	230	CDXM

Name-Plate Rating	MOTOR MODEL	70/076	70/106	70/156	120/106	120/156	120/206	200/156	200/206	
	Output	HP	0.75	1	1	1	1.5	2	1.5	2
		KW	0.55	0.75	1.1	0.75	1.1	1.5	1.1	1.5
	Phase	1	1	1	1	1	1	1	1	
	Poles	2	2	2	2	2	2	2	2	
	Volts	230	230	230	230	230	230	230	230	
	Amperes	3.4	5.2	7.9	5.2	7.2	11.3	6.7	10.2	
	Speed	3420	3430	3425	3425	3440	3475	3450	3490	
	Insulation Class	F	F	F	F	F	F	F	F	
Capacity of Capacitor μF	Start	-	-	-	-	-	-	-	-	
	Run	12.5	14	25	14	25	35	20	35	
No Load Test	Amperes	2.8	2.95	3.94	2.95	3.94	5.73	5.05	5.73	
	Watts	335	325	502	325	502	529	485	529	
Resistance at 20°C	Ohms	5.19	3.5	2.082	3.5	2.082	0.96	2.166	0.96	
100% Load	Current	4.09	5.3	7.2	5.3	7.2	10.5	6.7	10.5	
	Efficiency	62.1	67.7	70.1	67.7	70.1	80.3	67.7	80.3	
	Power Factor	91.8	81.4	91.6	81.4	91.6	88.7	90.9	88.7	
	Speed	3429	3512	3458	3512	3458	6492	3459	3492	
Locked Rotor Torque		0.53	0.66	0.82	0.66	0.82	1.49	0.82	1.49	
Start Current		17.34	19.9	23.9	20.1	23.9	32.6	23.9	32.6	
Number Starts per Hour		30								
Voltage Tolerance		±6								



Model CDX

EBARA Stainless Steel Centrifugal Pumps

Electrical Data

3/4 to 3 HP, Three Phase, 230V

Hz	Poles	Phase	Output (HP)	Voltage (V)	Applicable Model
60	2	Three	0.75-3	230	CDX

Name-Plate Rating	MOTOR MODEL	70/076	70/106	70/156	120/106	120/156	120/206	200/156	200/206	200/306
	Output	HP	0.75	1	1	1	1.5	2	1.5	2
	KW	0.55	0.75	1.1	0.75	1.1	1.5	1.1	1.5	2.2
	Phase	3	3	3	3	3	3	3	3	3
	Poles	2	2	2	2	2	2	2	2	2
	Volts	230	230	230	230	230	230	230	230	230
	Amperes	1.9	2.9	3.8	2.8	4	7.5	3.8	7.5	7.5
	Speed	3330	3450	3350	3350	3375	3480	3380	3360	3360
	Insulation Class	F	F	F	F	F	F	F	F	F
No Load Test	Amperes	1.12	2.02	2.52	2.02	2.52	4.6	2.52	4.6	4.6
	Watts	134	158	82	158	82	114	82	114	114
Resistance at 20°C	Ohms	12.6	7.06	3.2	7.06	3.2	1.34	3.2	1.34	1.34
100% Load	Current	1.98	2.8	4.28	2.8	4.28	8.16	4.28	8.16	8.16
	Efficiency	63.2	68.1	82.74	68.1	82.7	82.9	82.3	82.9	84.1
	Power Factor	73.6	74.2	76.3	74.2	76.3	77	76.3	77	77
	Speed	3418	3436	3447	3436	3447	3480	3447	3480	3480
Locked Rotor Torque		2.54	4.17	7.55	4.17	7.55	12.41	7.55	12.41	12.41
Start Current		6.55	17.2	25.7	17.2	25.7	58.23	25.7	58.23	58.23
Number Starts per Hour		30								
Voltage Tolerance		±10								



Model CDX

EBARA Stainless Steel Centrifugal Pumps

Electrical Data

3/4 to 3 HP, Three Phase, 460V

Hz	Poles	Phase	Output (HP)	Voltage (V)	Applicable Model
60	2	Three	0.75-3	460	CDX

Name-Plate Rating	MOTOR MODEL	70/076	70/106	70/156	120/106	120/156	120/206	200/156	200/206	200/306
	Output	HP	0.75	1	1.5	1	1.5	2	1.5	2
	KW	0.55	0.75	1.1	0.75	1.1	1.5	1.1	1.5	2.2
	Phase	3	3	3	3	3	3	3	3	3
	Poles	2	2	2	2	2	2	2	2	2
	Volts	460	460	460	460	460	460	460	460	460
	Amperes	1.2	1.6	2.2	1.7	2.2	4.1	2.2	4.1	4.1
	Speed	3330	3450	3350	3350	3375	3480	3380	3360	3360
	Insulation Class	F	F	F	F	F	F	F	F	F
No Load Test	Amperes	0.65	1.17	1.27	1.17	1.27	2.30	1.27	2.30	2.3
	Watts	134	158	82	158	82	114	82	114	114
Resistance at 20°C	Ohms	37.9	21.2	9.6	21.2	9.6	4.01	9.6	4.01	4.01
100% Load	Current	1.15	1.62	2.15	1.62	2.15	4.10	2.15	4.10	4.10
	Efficiency	63.2	68.1	84.44	68.1	84.44	87.4	84.44	87.4	87.4
	Power Factor	73.6	74.2	76.3	74.2	76.3	77	76.3	77	77
	Speed	3418	3436	3447	3436	3447	3480	3447	3480	3480
Locked Rotor Torque		3.37	5.53	9.98	5.53	9.98	16.41	9.98	16.41	16.41
Start Current		3.28	8.60	17.2	8.60	17.2	38.9	17.2	38.9	38.9
Number Starts per Hour		30								
Voltage Tolerance		±10								

