

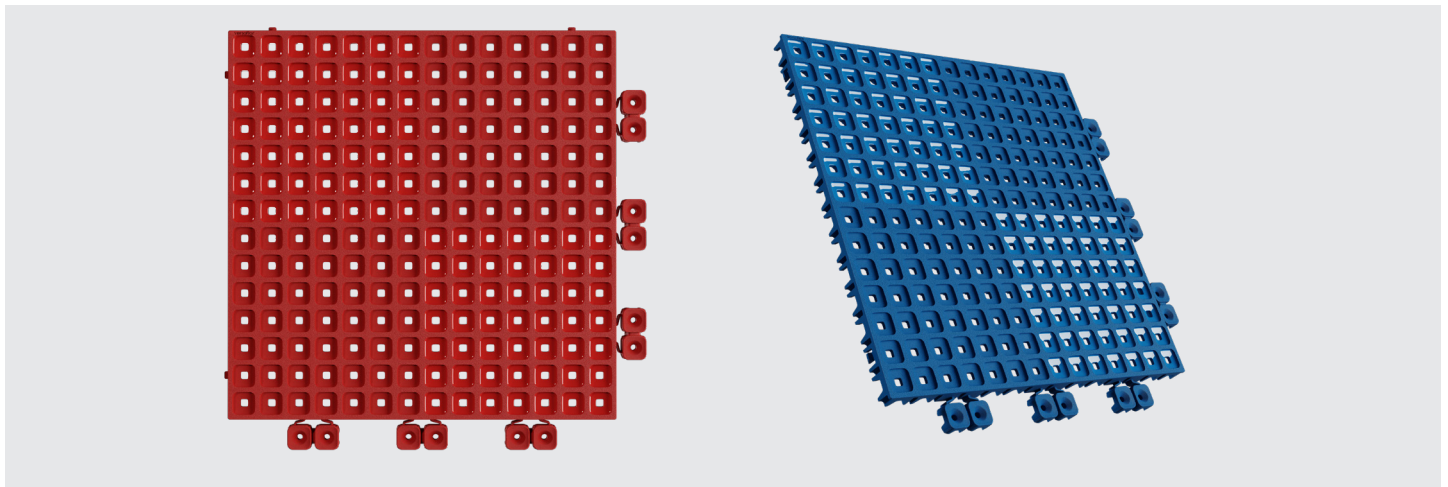

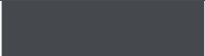







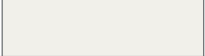
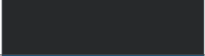

UPFLOR® (pack of 9 tiles)



UPFLOR® is a quick and easy-to-install flooring tile that provides a durable, anti-slip surface with drainage - ideal for garages, home spas, pools, outdoor use and many other applications - and can be customised with our range of accessories including colourful mosaics and underfloor LED lighting kit.

PHYSICAL		UPFLOR® (pack of 9)		
Material	Recyclable Polyprobe	Colour Description	Colour	SKU
Height, Length, Depth	0.55" x 12" x 12" (1ft sq)	Dark Grey		VF001/7024
Expansion Gap (Between ASSEMBLED TILES)	0.10"	Mid Grey		VF001/7030
Weight	356g	Light Grey		VF001/7047
TECHNICAL		Sail White		VF001/9016
Load Capacity	15,000 Kg	Charcoal Black		VF001/9011
Fire Resistance (EN ISO 9239-1:2010)	Class Efl-s2	Ocean Blue		VF001/5005
Slip Risk Classification (BS 7976-2)	Low (Dry 107 PVT, Wet 54 PVT)	Mars Red		VF001/3020
Max. Cable Diameter (beneath tile)	0.3"	Pumpkin Orange		VF001/2004
UV Protection	Yes	Stone Beige		VF001/1001
Mosaic Compatible?	Yes	light Blue		VF001/5012
Versatility	Can be used with Taskflor	light green		VF001/6027
Warranty	3 Years	Bright Green		VF001/6038
		Midnight Blue		VF001/5026
		Deep Purple		VF001/4001
		Sulpher Yellow		VF001/1016

DIMENSIONS

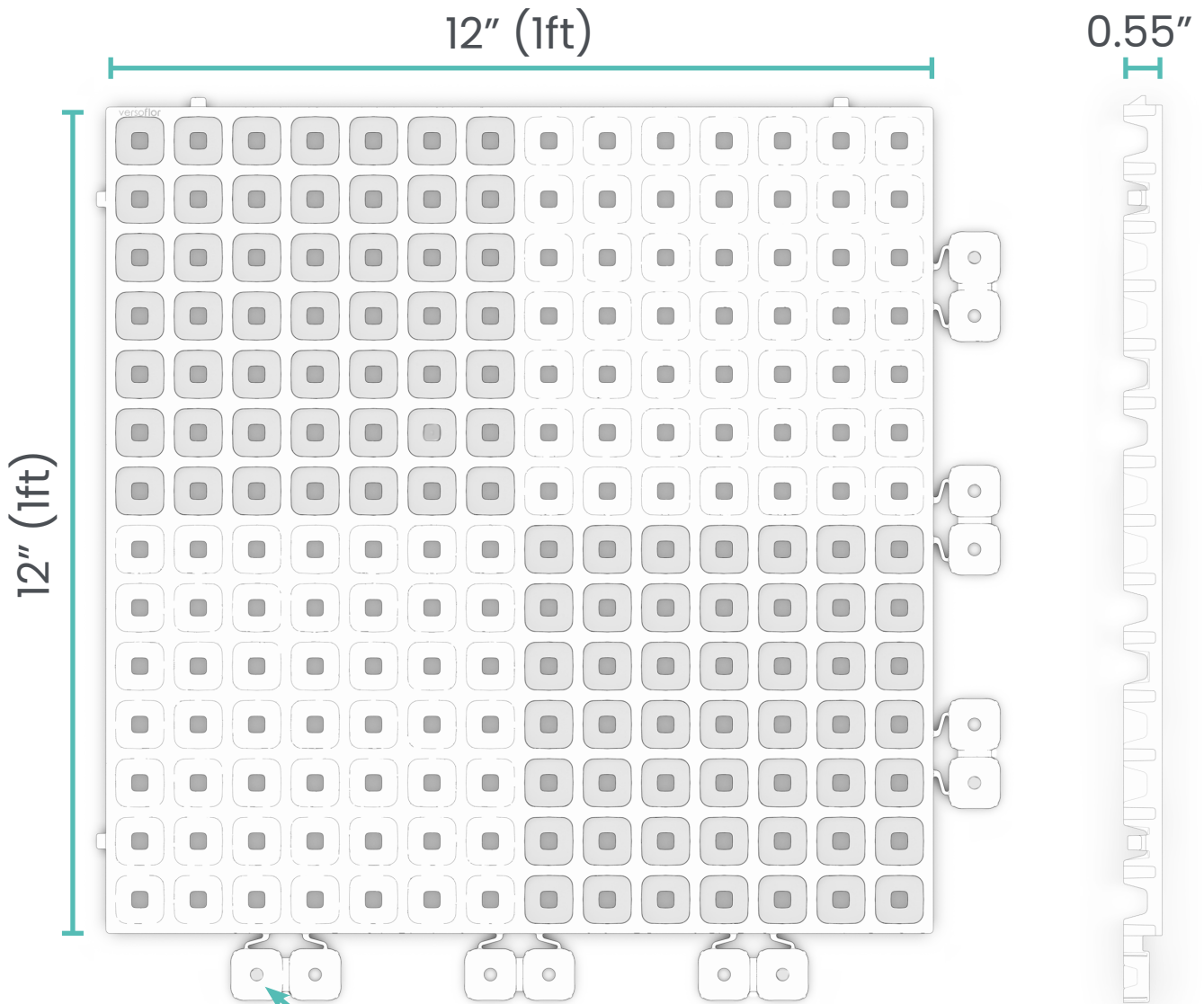

Compatible with 4-6mm masonry screw

COMPATIBLE PRODUCTS

Upflor Accessories / Taskflor Accessories

ACCESSORIES

Mosaics (Various Colours)	VF002
Edge Strips (Various Colours)	VF003
Corners (Various Colours)	VF004
Connectors	VF005
Cable Clips	VF006
Versodeck LED Kit - 5.1m Strip	VF007

TASKFLOR® (pack of 9 tiles)

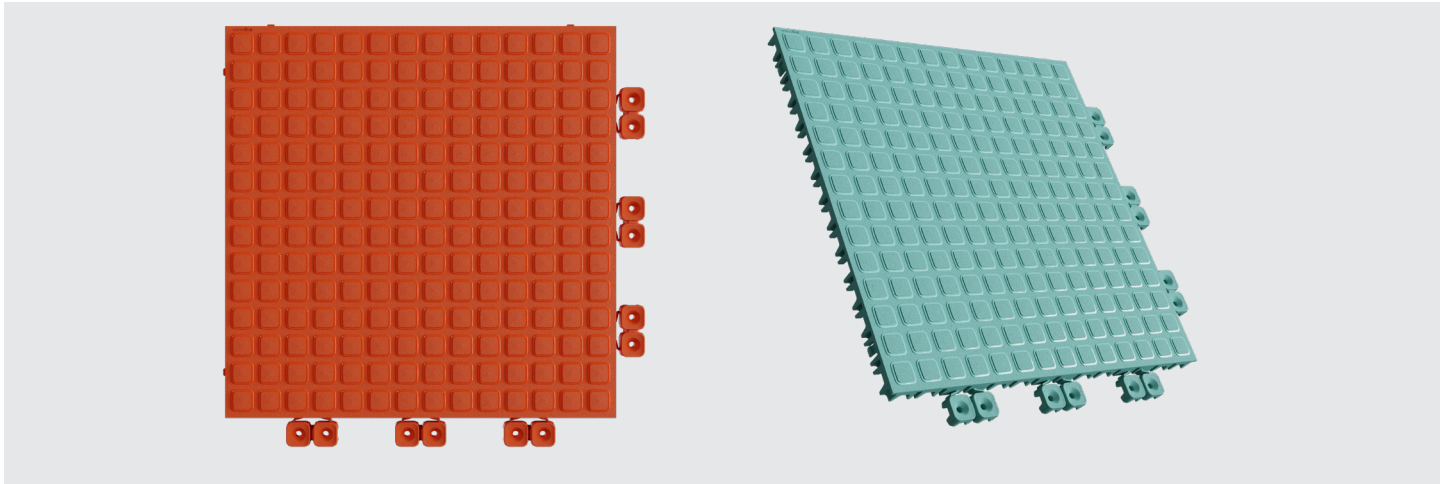

Taskflor is a quick and easy-to-install flooring tile that provides a durable, anti-slip surface - ideal for garages, home spas, pools, outdoor spaces and many other applications.

PHYSICAL		Taskflor® (pack of 9)		
Material	Recyclable Polytrobe	Colour Description	Colour	SKU
Height, Length, Depth	0.55" x 12" x 12" (1ft sq)	Dark Grey		VF009/7024
Expansion Gap (Between ASSEMBLED TILES)	0.10"	Mid Grey		VF009/7030
Weight	348g	Light Grey		VF009/7047
TECHNICAL		Sail White		VF009/9016
Load Capacity	15,000 Kg	Charcoal Black		VF009/9011
Fire Resistance (EN ISO 9239-1:2010)	Class Efl-s2	Ocean Blue		VF009/5005
Slip Risk Classification (BS 7976-2)	Low (Dry 99 PVT, Wet 51 PVT)	Mars Red		VF009/3020
Max. Cable Diameter (beneath tile)	0.3"	Pumpkin Orange		VF009/2004
UV Protection	Yes	Stone Beige		VF009/1001
Mosaic Compatible?	No	light Blue		VF009/5012
Versatility	Can be used with Upflor	light green		VF009/6027
Warranty	3 Years	Bright Green		VF009/6038
		Midnight Blue		VF009/5026
		Deep Purple		VF009/4001
		Sulpher Yellow		VF009/1016

DIMENSIONS

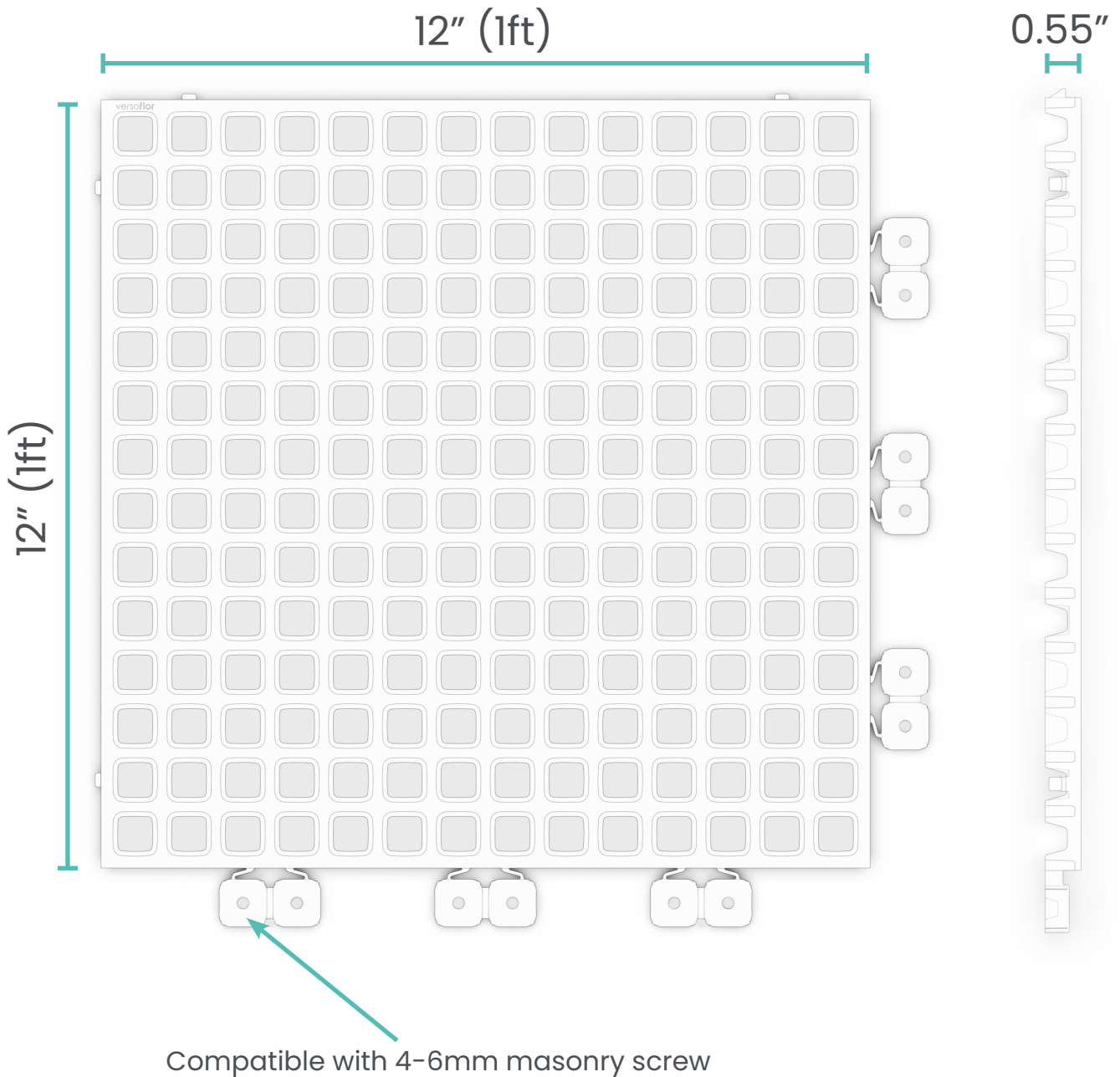

COMPATIBLE PRODUCTS

Upflor Accessories / Taskflor Accessories











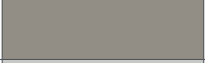
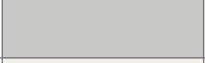

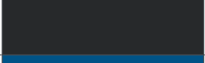
ACCESSORIES

Edge Strips (Various Colours)	VF003
Corners (Various Colours)	VF004
Connectors	VF005
Cable Clips	VF006
Versodeck LED Kit - 5.1m Strip	VF007

Mosaics (pack of 100)



Add colour, texture and style to your Upflor tiles by using our simple push-in Mosaics. Be inspired by the range of designs shown on our website, or get creative and have fun making your own. The possibilities are endless!

PHYSICAL		Edge Strips (pack of 9)		
Material	Recyclable Polytrobe	Colour Description	Colour	SKU
Height, Length, Depth	0.6" x 0.6" x 0.4"	Dark Grey		VF002/7024
Weight	<1g	Mid Grey		VF002/7030
TECHNICAL		Light Grey		VF002/7047
Load Capacity	15,000 Kg	Sail White		VF002/9016
Fire Resistance (EN ISO 9239-1:2010)	Class Efl-s2	Charcoal Black		VF002/9011
Slip Risk Classification (BS 7976-2)	Low (Dry 107 PVT, Wet 54 PVT)	Ocean Blue		VF002/5005
UV Protection	Yes	Mars Red		VF002/3020
Warranty	3 Years	Pumpkin Orange		VF002/2004
		Stone Beige		VF002/1001
		light Blue		VF002/5012
		light green		VF002/6027
		Bright Green		VF002/6038
		Midnight Blue		VF002/5026
		Deep Purple		VF002/4001
		Sulphur Yellow		VF002/1016

DIMENSIONS

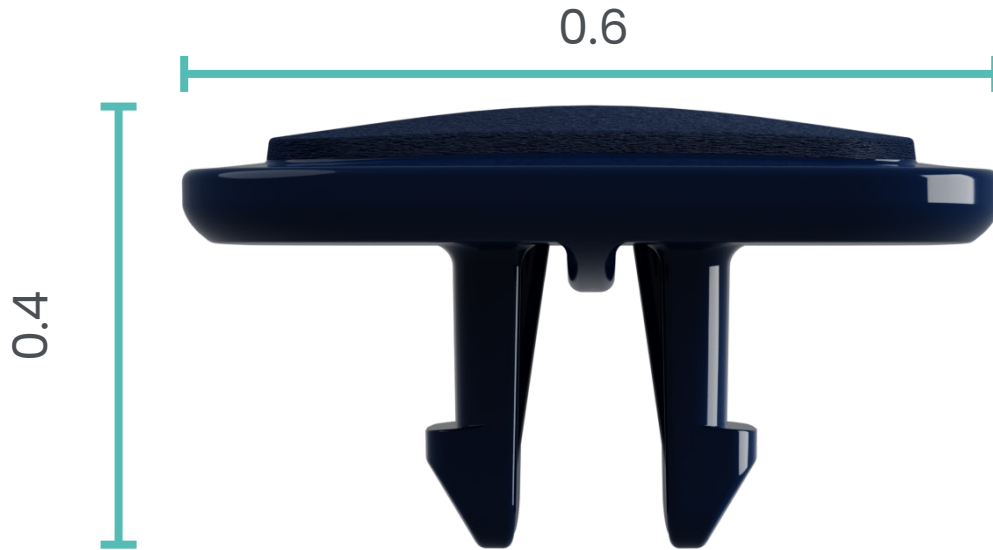

COMPATIBLE PRODUCTS

Upflor Tiles and Accessories

ACCESSORIES

Upflor Tiles	VF001
Edge Strips (Various Colours)	VF003
Corners (Various Colours)	VF004
Connectors	VF005
Cable Clips	VF006
Versodeck LED Kit - 5.1m Strip	VF007

Edges (pack of 6)

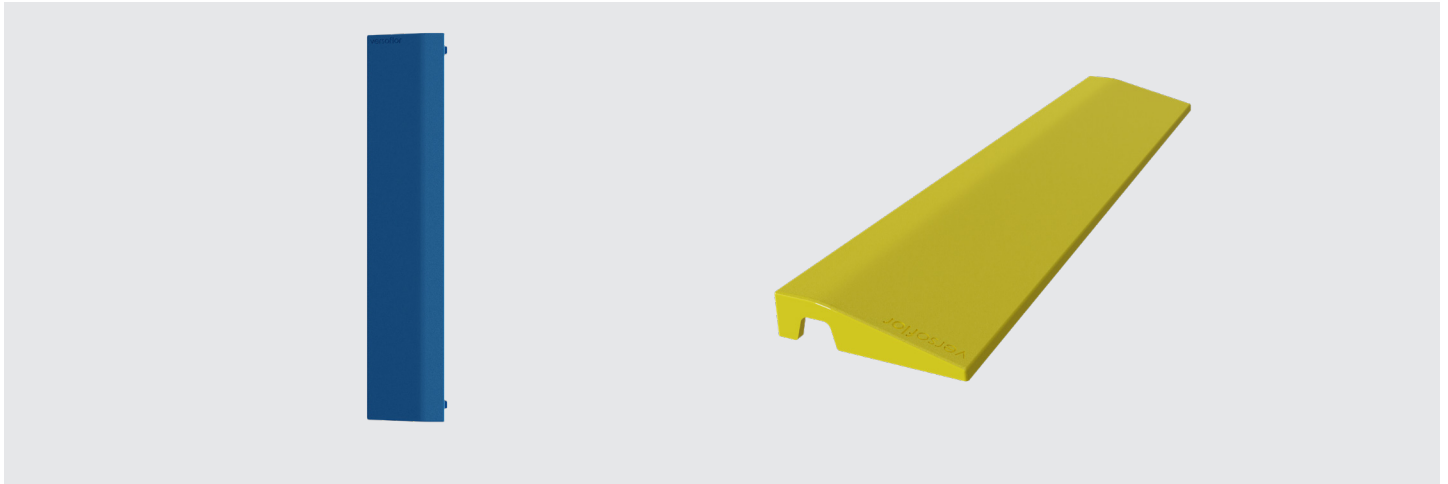

Finish off your amazing space with our quality Edge Strips. Ideal for transitioning from your base surface to Upflor and Taskflor products, creating a gentle ramp and a quality final touch.

PHYSICAL		Edge Strips (pack of 9)		
Material	Recyclable Polytrobe	Colour Description	Colour	SKU
Height, Length, Depth	0.6" x 12" x 1.2"	Dark Grey		VF003/7024
Weight	51g	Mid Grey		VF003/7030
TECHNICAL		Light Grey		VF003/7047
Load Capacity	15,000 Kg	Sail White		VF003/9016
Fire Resistance (EN ISO 9239-1:2010)	Class Efl-s2	Charcoal Black		VF003/9011
Slip Risk Classification (BS 7976-2)	Low (Dry 99 PVT, Wet 51 PVT)	Ocean Blue		VF003/5005
UV Protection	Yes	Mars Red		VF003/3020
Warranty	3 Years	Pumpkin Orange		VF003/2004
		Stone Beige		VF003/1001
		light Blue		VF003/5012
		light green		VF003/6027
		Bright Green		VF003/6038
		Midnight Blue		VF003/5026
		Deep Purple		VF003/4001
		Sulphur Yellow		VF003/1016

DIMENSIONS

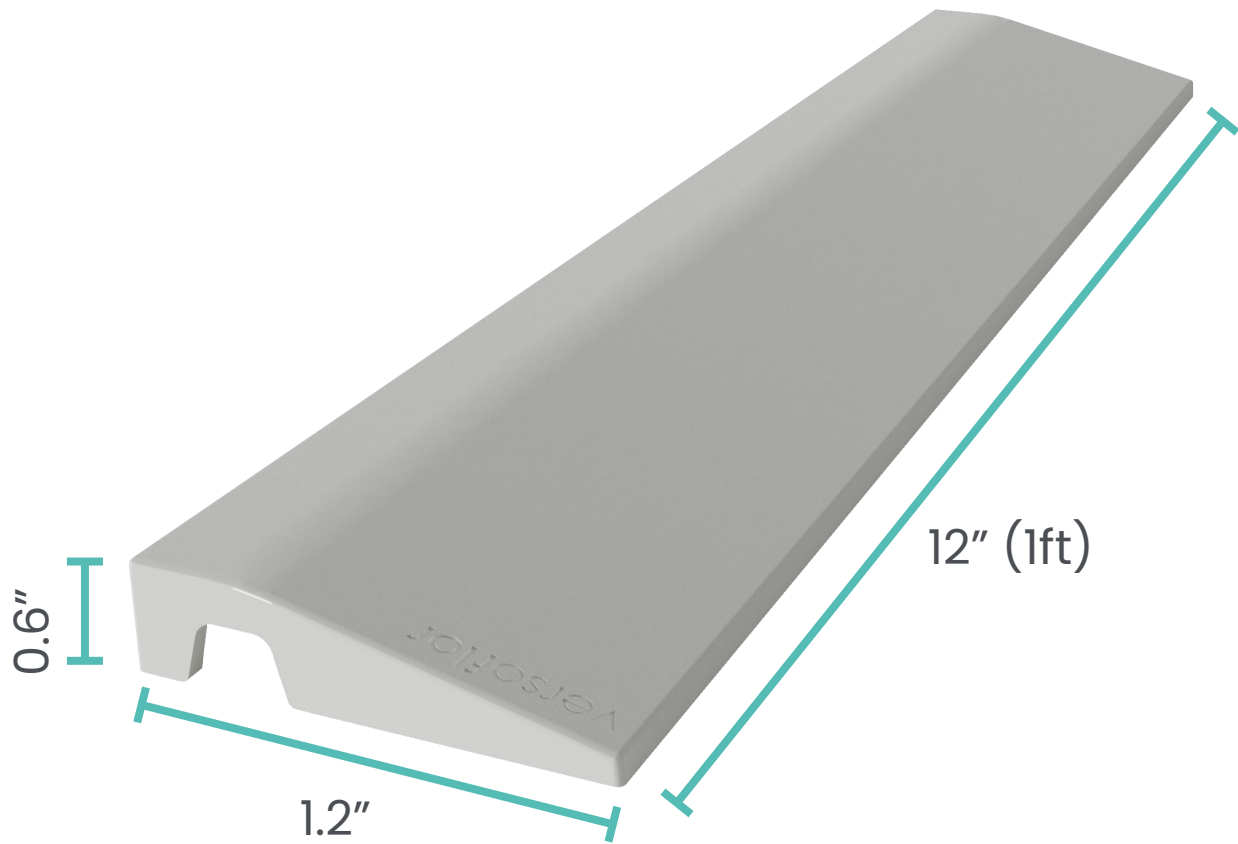

COMPATIBLE PRODUCTS

Upflor / Taskflor tiles and Accessories

ACCESSORIES

Upflor / Taskflor tiles	VF001 / VF009
Mosaics (Various Colours)	VF002
Edge Strips (Various Colours)	VF003
Corners (Various Colours)	VF004
Connectors	VF005
Cable Clips	VF006
Versodeck LED Kit - 5.1m Strip	VF007

Corners (pack of 4)

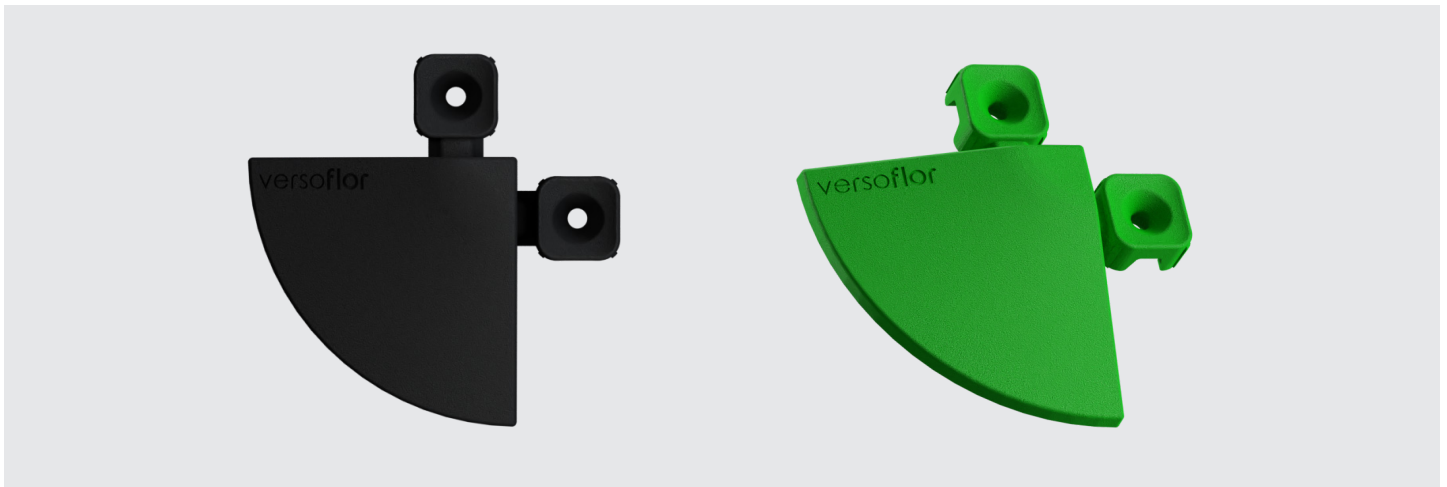

Corners will neatly finish off your amazing space. Used in combination with our Edge Strips, these are ideal for transitioning from your base surface to Upflor and Taskflor products, creating a gentle ramp and a quality final touch.

PHYSICAL		Edge Strips (pack of 9)	
Material	Recyclable Polytrobe	Dark Grey	VF004/7024
Height, Length, Depth	0.55 x 2.4" x 2.4"	Mid Grey	VF004/7030
Weight	11g	Light Grey	VF004/7047
TECHNICAL		Sail White	VF004/9016
Load Capacity	15,000 Kg	Charcoal Black	VF004/9011
Fire Resistance (EN ISO 9239-1:2010)	Class Efl-s2	Ocean Blue	VF004/5005
Slip Risk Classification (BS 7976-2)	Low (Dry 99 PVT, Wet 51 PVT)	Mars Red	VF004/3020
UV Protection	Yes	Pumpkin Orange	VF004/2004
Warranty	3 Years	Stone Beige	VF004/1001
		light Blue	VF004/5012
		light green	VF004/6027
		Bright Green	VF004/6038
		Midnight Blue	VF004/5026
		Deep Purple	VF004/4001
		Sulpher Yellow	VF004/1016

DIMENSIONS

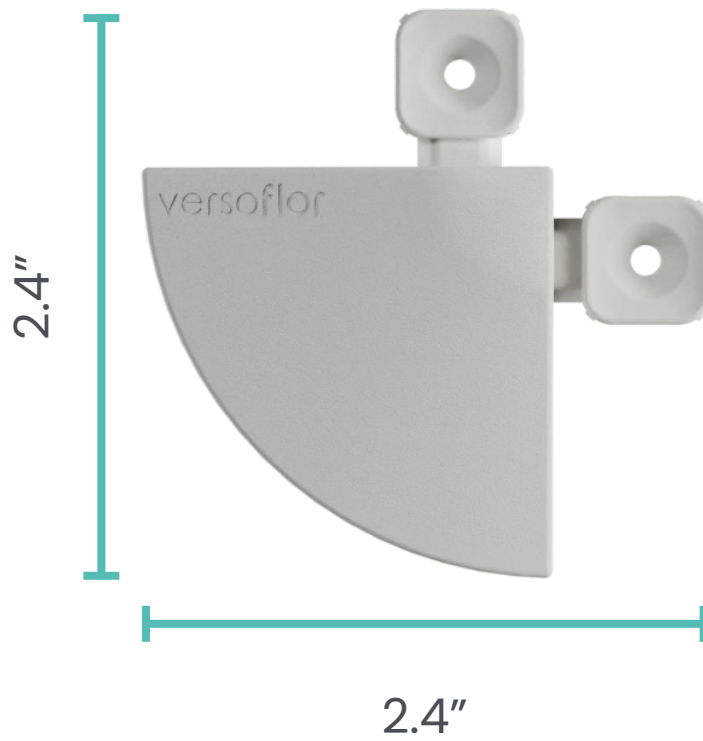

COMPATIBLE PRODUCTS

Upflor / Taskflor tiles and Accessories

ACCESSORIES

Upflor / Taskflor tiles	VF001 / VF009
Mosaics (Various Colours)	VF002
Edge Strips (Various Colours)	VF003
Corners (Various Colours)	VF004
Connectors	VF005
Cable Clips	VF006
Versodeck LED Kit - 5.1m Strip	VF007

Versostop (pack of 2)

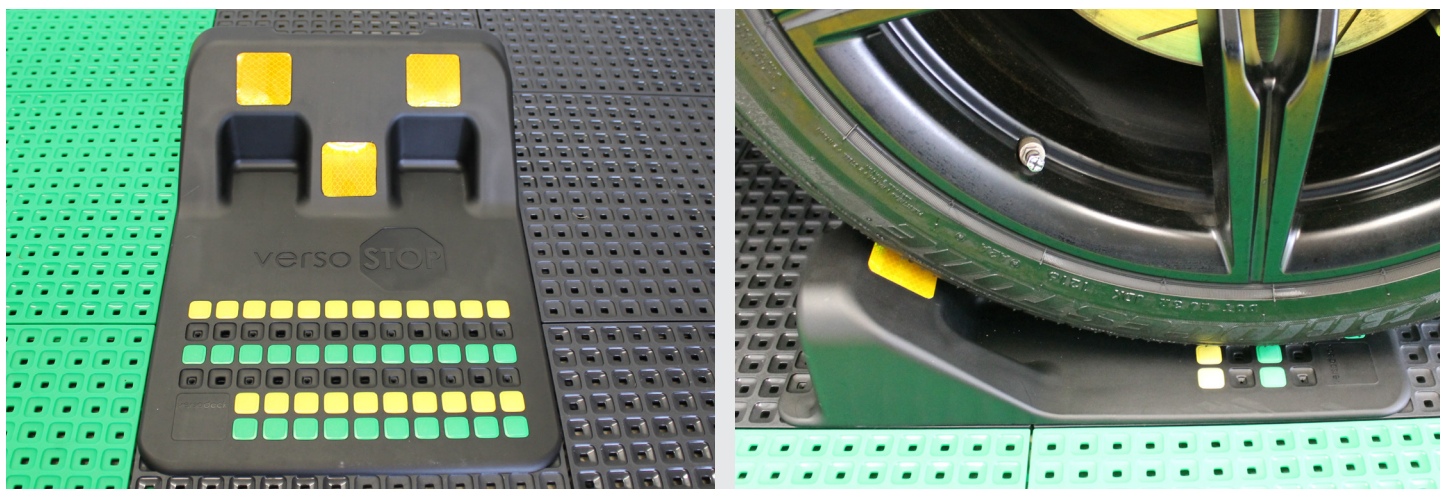

Versostop fits neatly into Versodeck Upflor tiles, to accurately park your vehicle, eliminating the risk of accidental damage from misjudged parking. Mosaic tiles can be added to match your current floor design, making Versostop an essential addition to your garage.

PHYSICAL		COMPATIBLE PRODUCTS	
Material	Recyclable Polyprobe	Upflor tiles and Accessories	
Height, Length, Depth	4" x 17" x 12"	ACCESSORIES	
Weight	4.96g	Upflor / Taskflor tiles	VF001 / VF009
TECHNICAL		Mosaics (Various Colours)	VF002
SKU	VF011/VERSOSTOP	Edge Strips (Various Colours)	VF003
Load Capacity	15,000 Kg	Corners (Various Colours)	VF004
Fire Resistance (EN ISO 9239-1:2010)	Class Efl-s2	Connectors	VF005
Slip Risk Classification (BS 7976-2)	Low (Dry 99 PVT, Wet 51 PVT)	Cable Clips	VF006
UV Protection	Yes	Versodeck LED Kit - 5.1m Strip	VF007
Warranty	3 Years		

DIMENSIONS

