

SAiGE

Composite Products

Longlife Decking

Hollow decking installation guide 2021

Our manufactured composite boards make the decking a dream for installers to work with, creating a long-lasting, hard-wearing product which comes with a full 10 year warranty and an expected lifespan of over 20 years.

This is a supporting document to the full Installation Guide (available on our website www.compositedecking.co.uk). Please ensure Installation is followed as per the Installation Guides for SAiGE's warranty to apply. For any clarification or information please contact a member of the SAiGE Team on +44 (0) 1789 721 576 or email info@saigedecking.com

V.1.4 MARCH 2021

HIGH STRENGTH

HIGH SPECIFICATION

BRITISH DESIGN

AWARD WINNING

QUALITY AND TEST CERTIFICATION

100% QUALITY INSPECTION



Notes

Saige decking construction featuring step and border

Frame 15mm away from wall

Hollow strip infill

Solid strip border

100mm airflow must be allowed on at least 2 sides of the decking

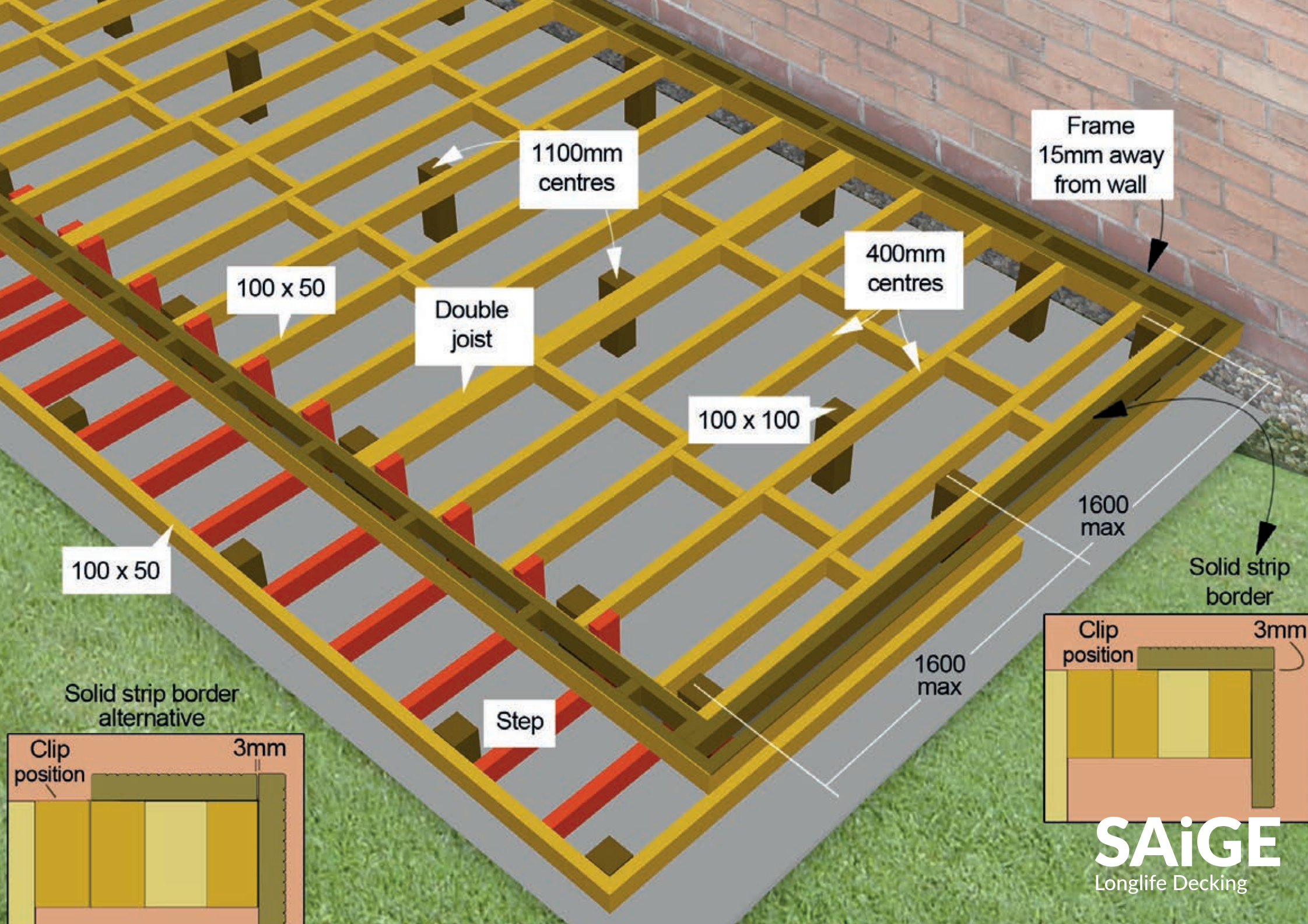

1100mm centres

Frame 15mm away from wall

400mm centres

100 x 50

Double joist

100 x 100

100 x 50

1600 max

Solid strip border

Solid strip border alternative

Step

1600 max

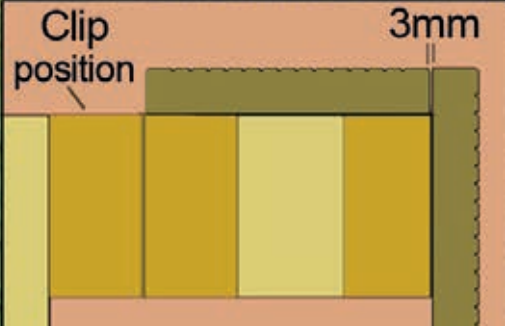
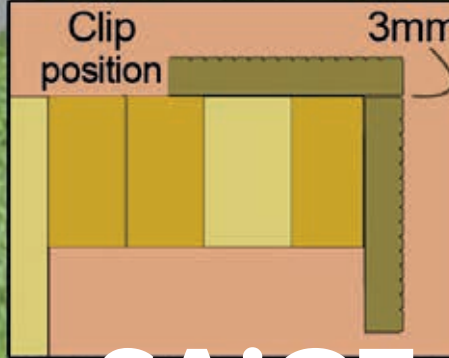

SAiGE
Longlife Decking

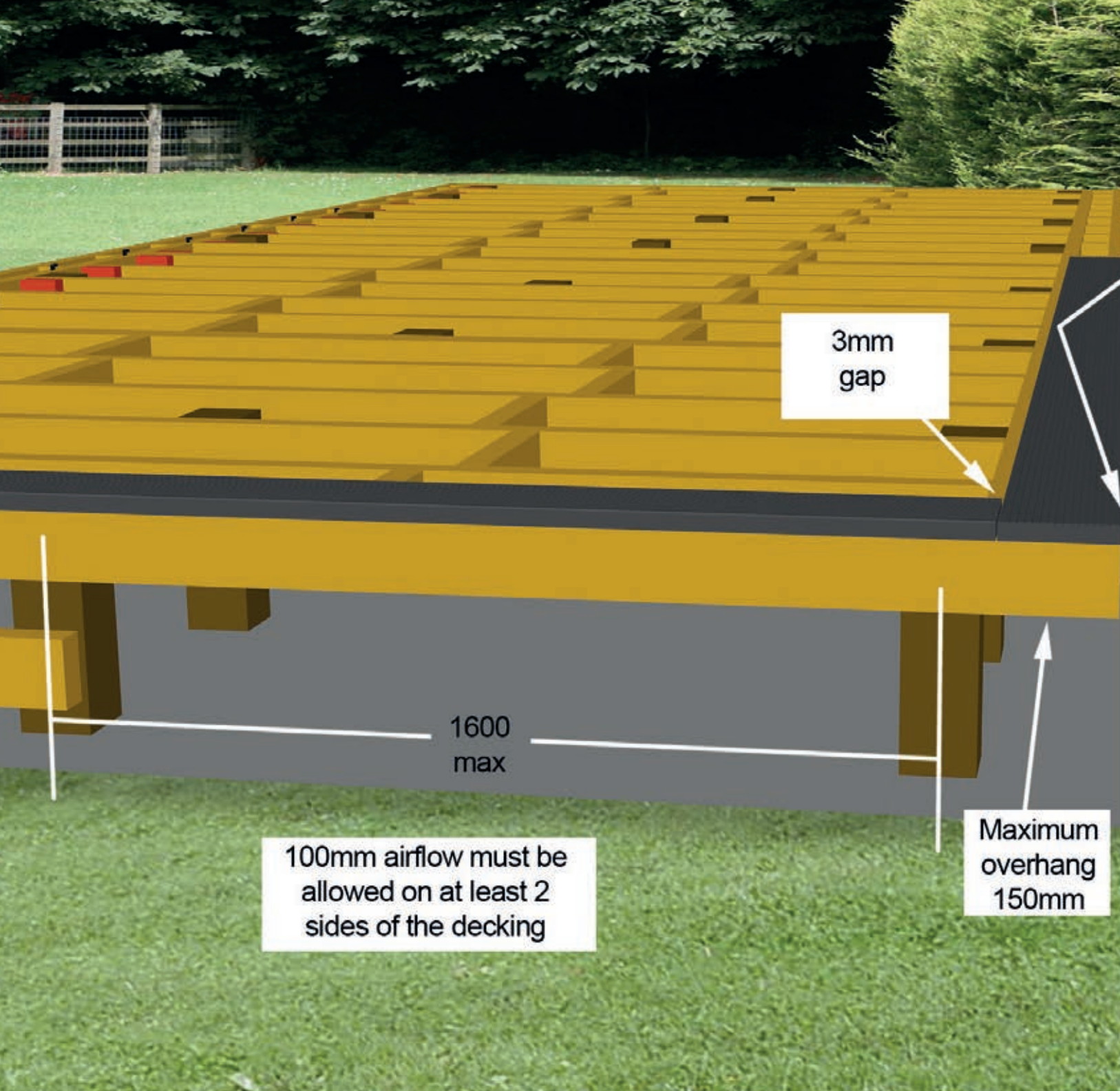

Border strip and edge lined up

3mm gap

15mm gap from wall

1600 max

Maximum overhang 150mm

100mm airflow must be allowed on at least 2 sides of the decking

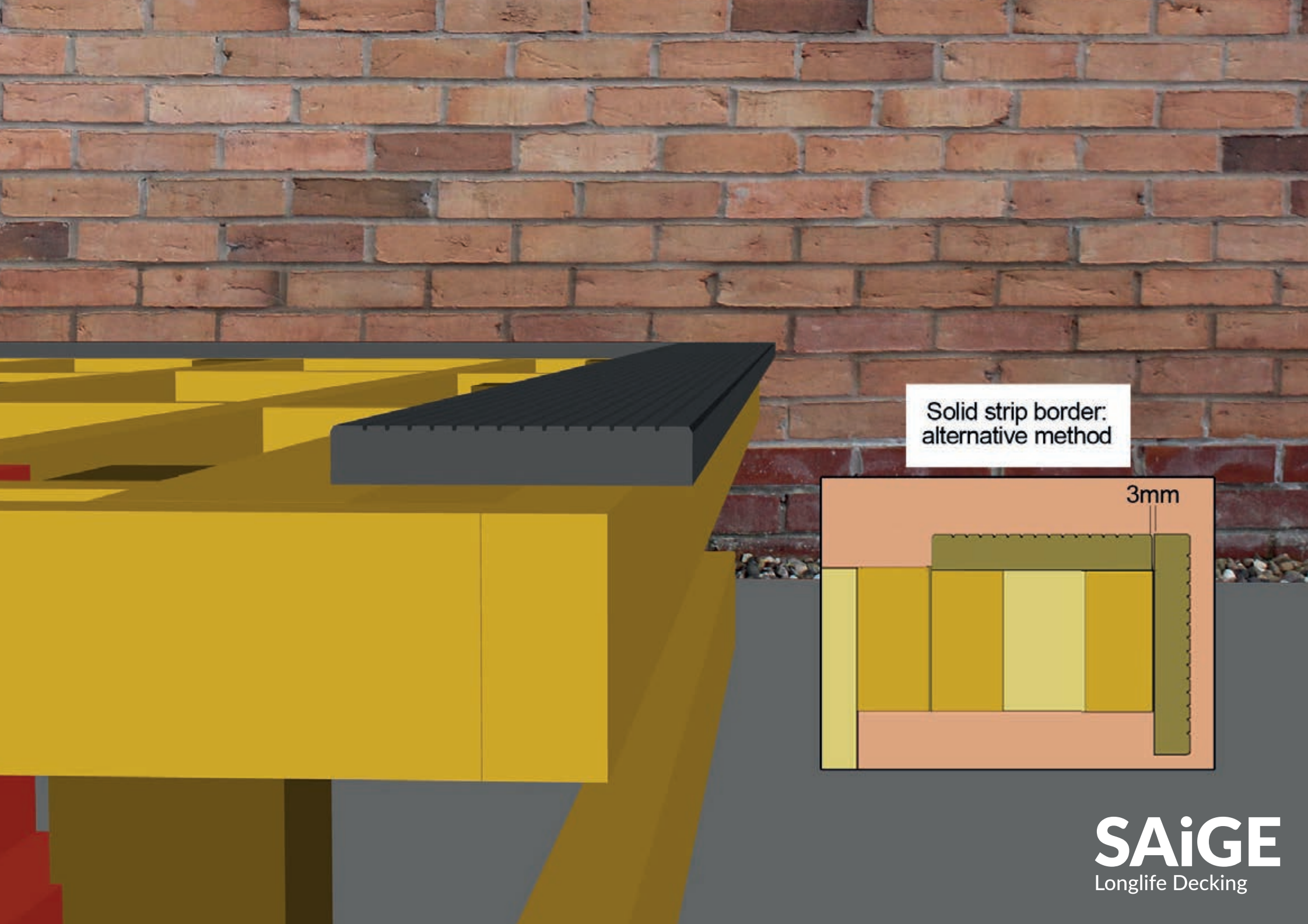

Solid strip border:
alternative method

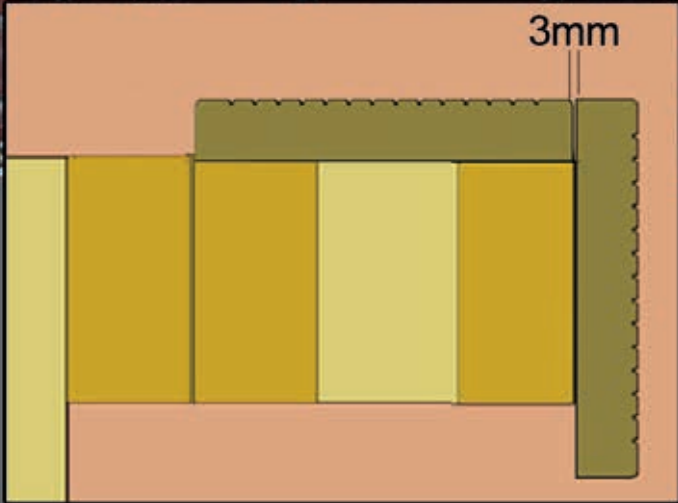



2

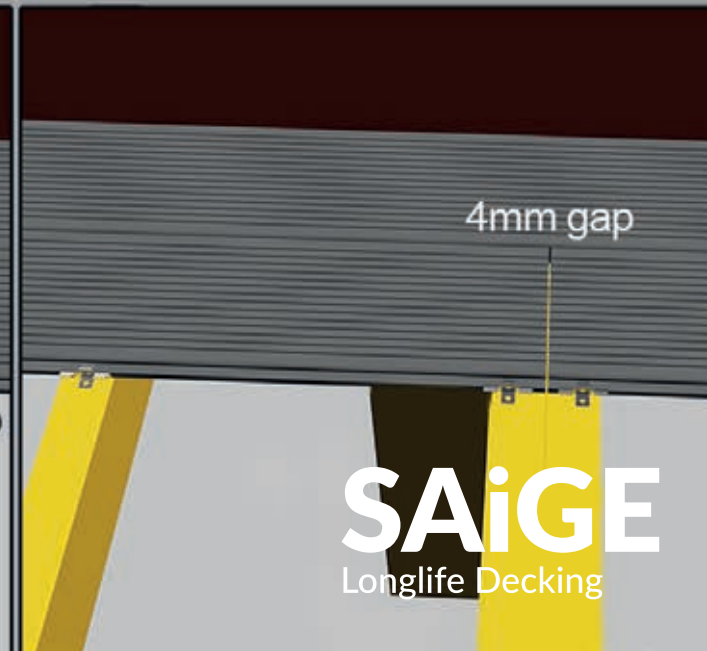
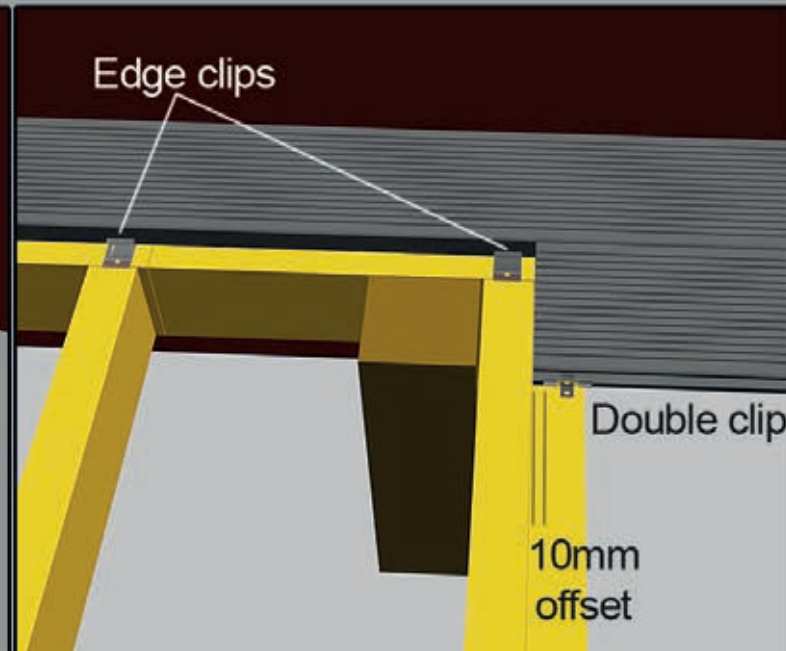
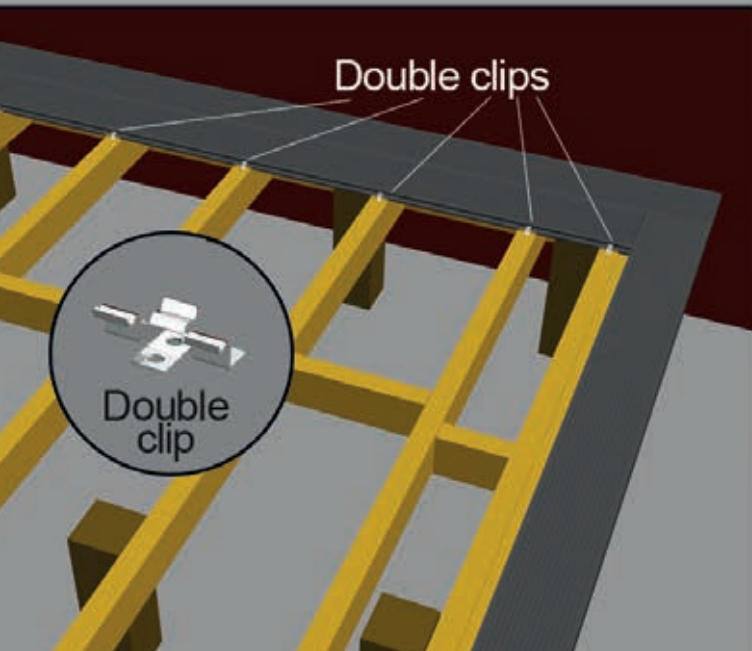

SAiGE
Longlife Decking

Row 2



Row 3



Row 4



SAiGE
Longlife Decking

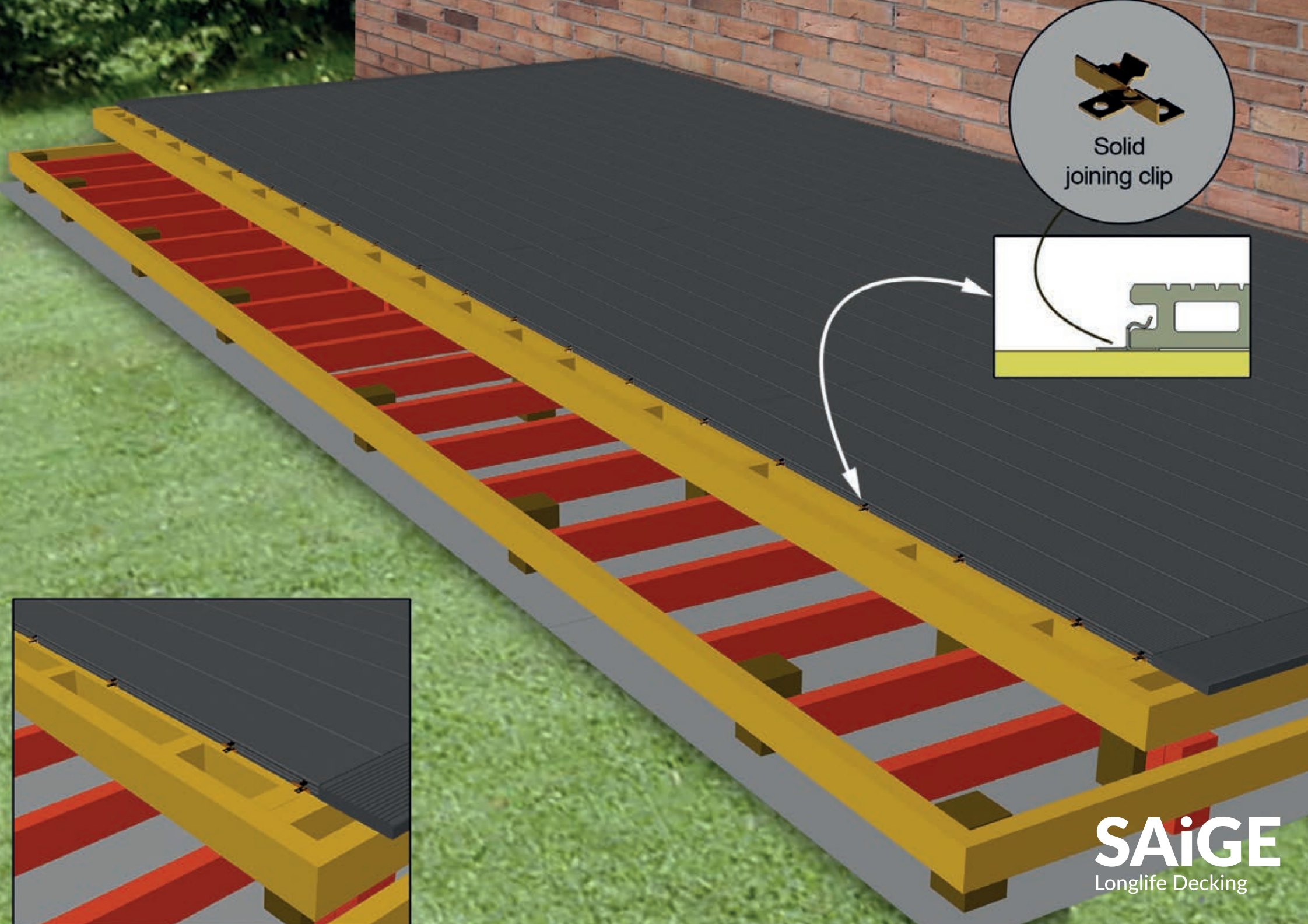

Solid joining clip

SAiGE
Longlife Decking

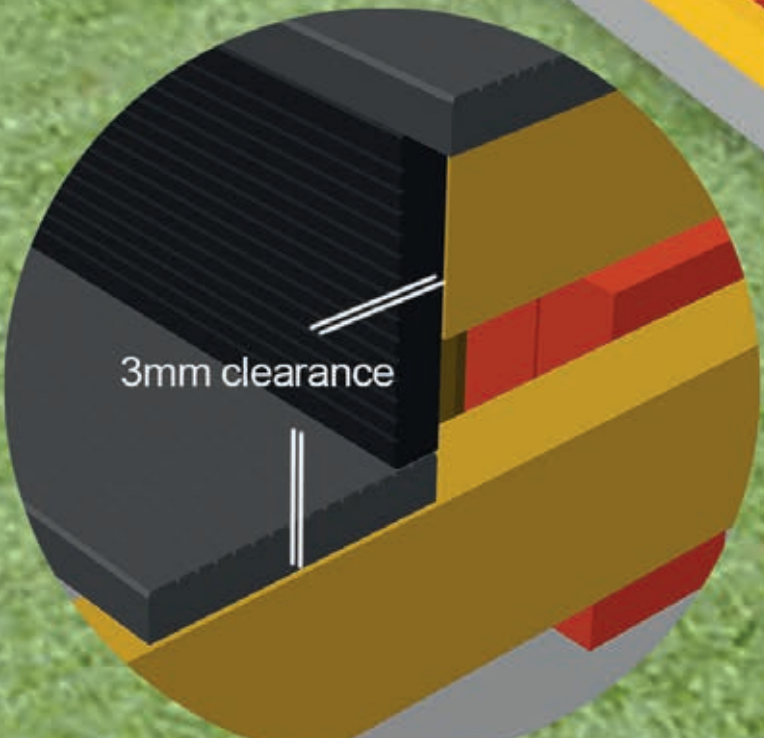
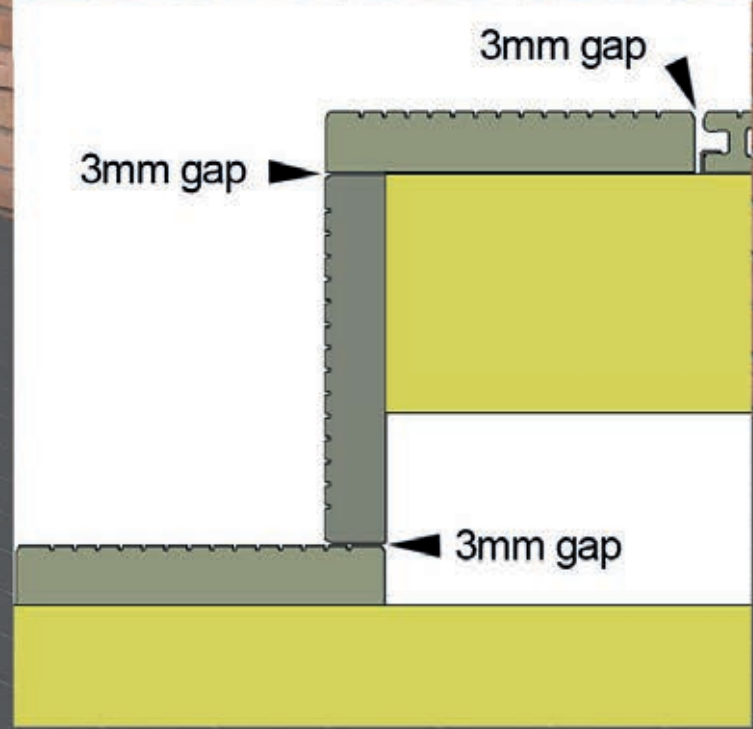
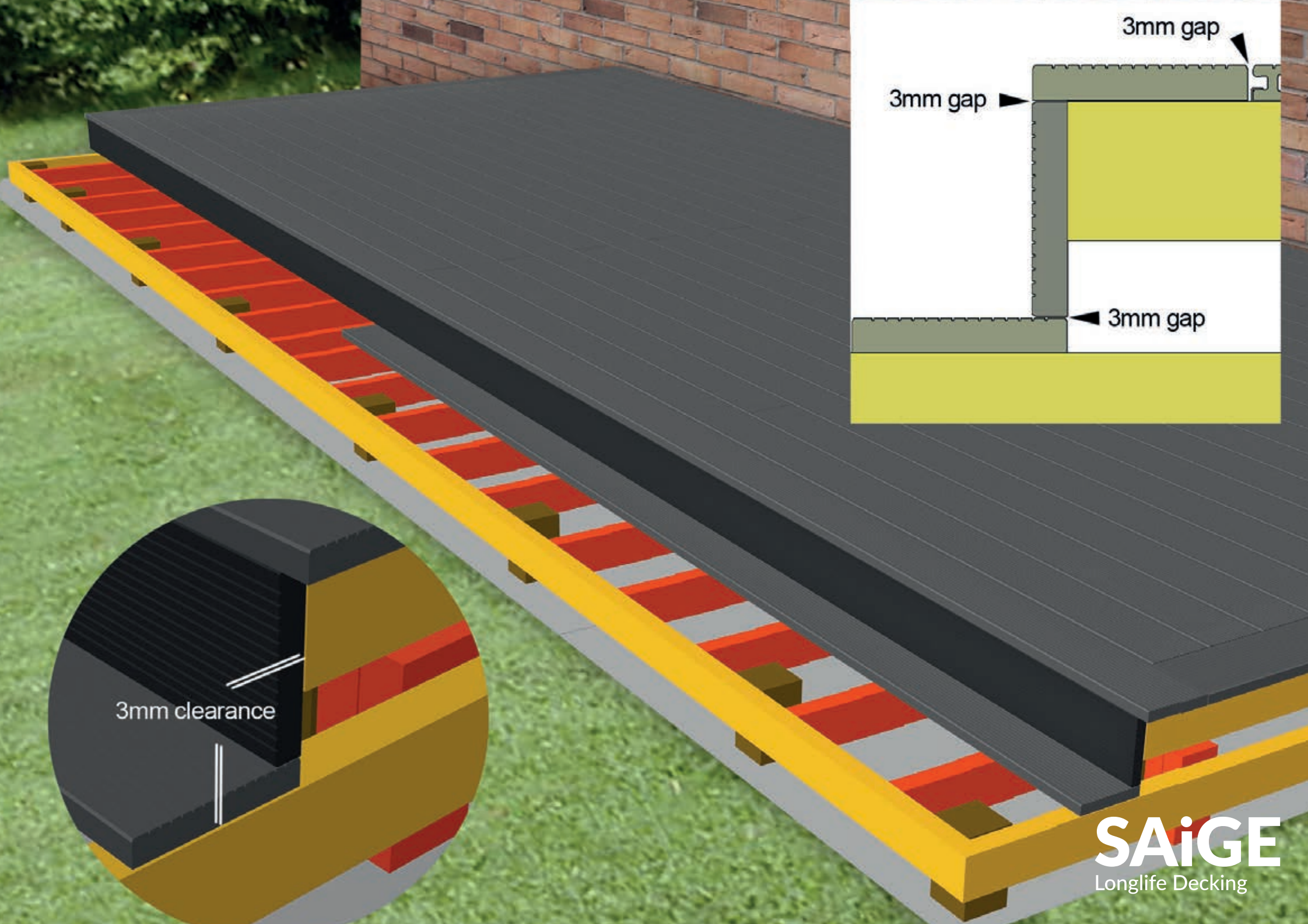

SAiGE
Longlife Decking

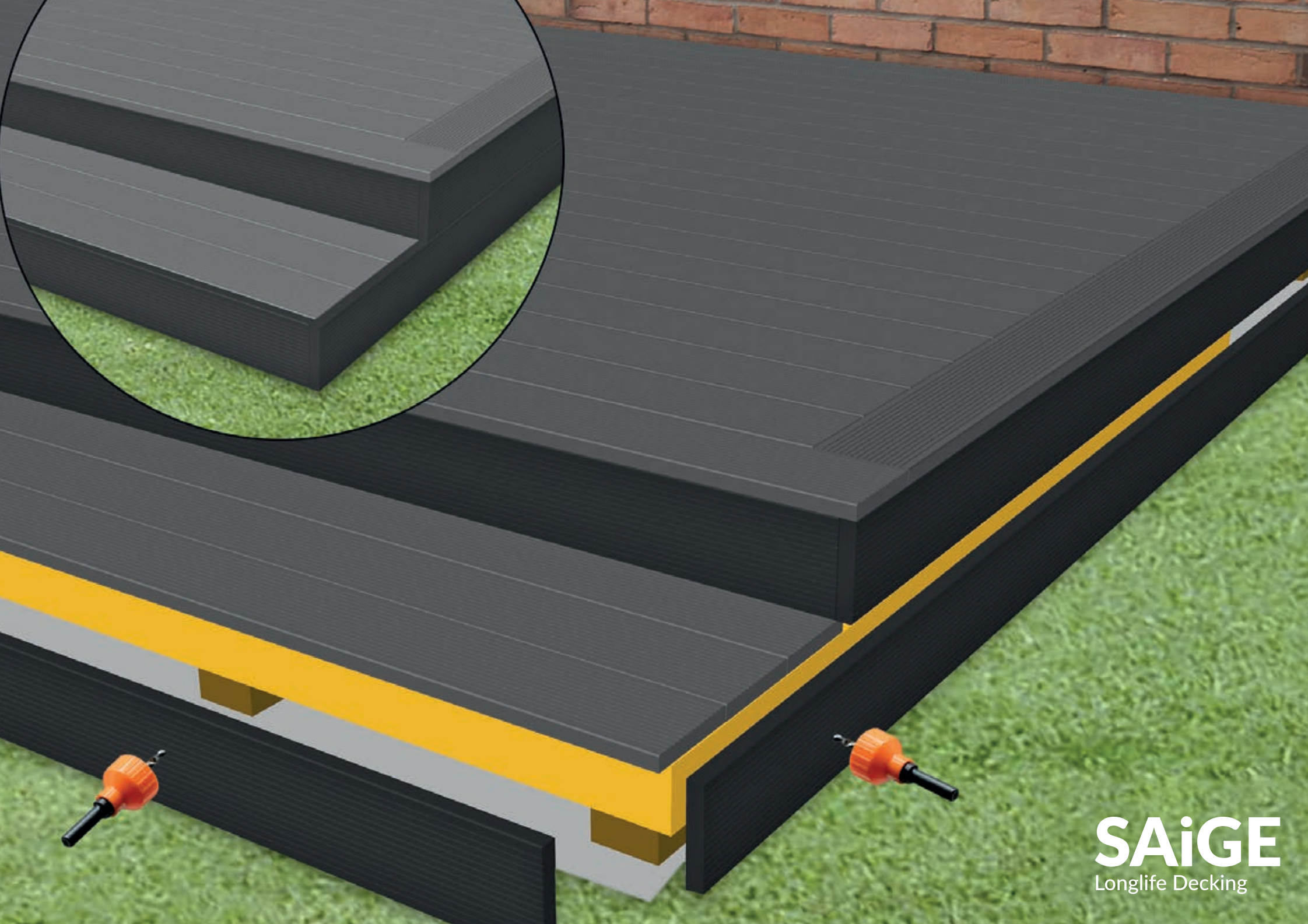

SAiGE
Longlife Decking

